

PACKO ALWAYS A STEP AHEAD

VERDER
passion for pumps

ROTARY LOBE PUMPS | CIRCUMFERENTIAL PISTON PUMPS | TWIN SCREW PUMPS

PACKO

The hygienic pump
specialist



- ✓ Large selection
- ✓ Best quality
- ✓ Highest standards

Packo

VERDER is manufacturer of PACKO pumps

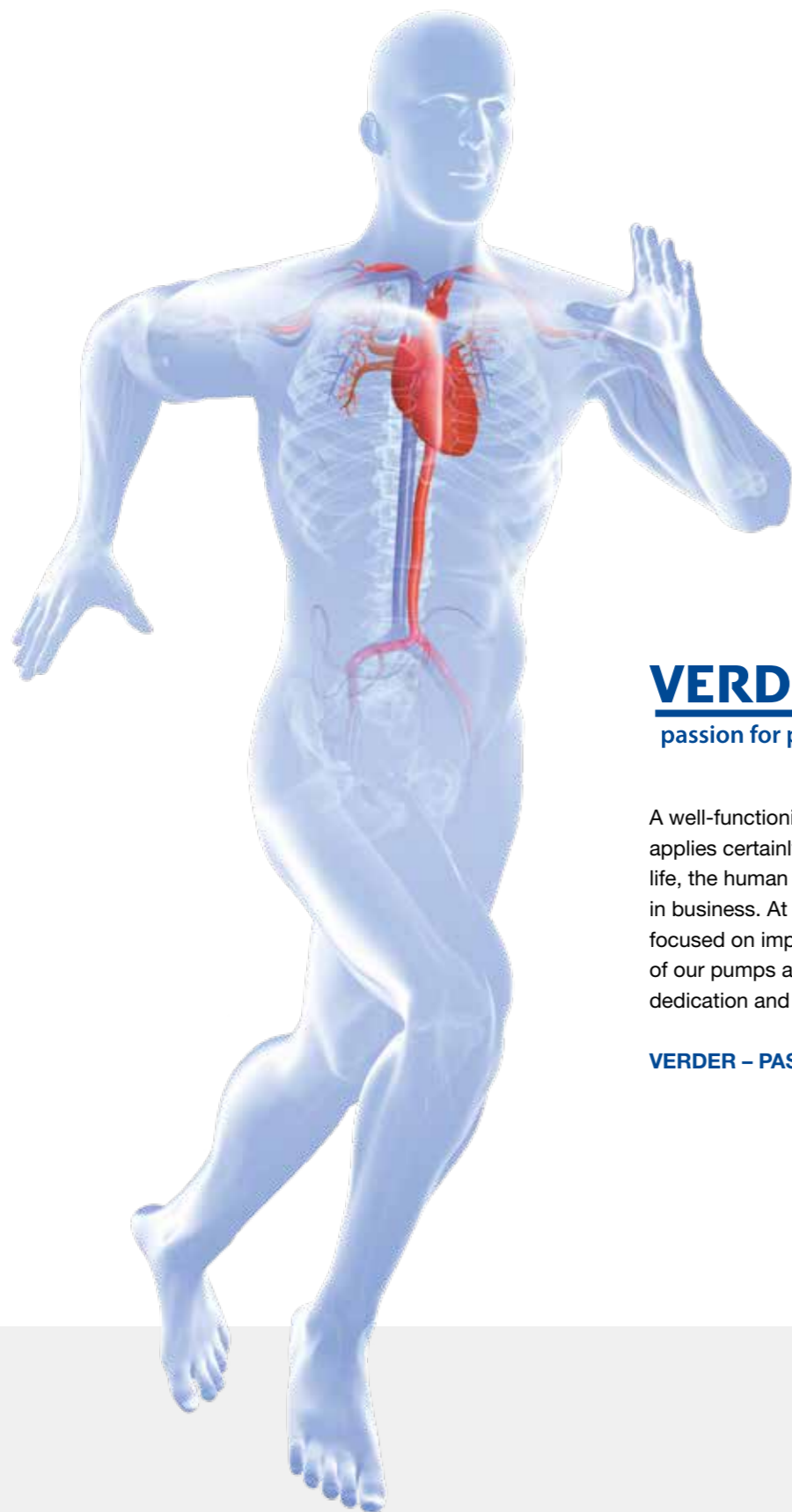

VERDER
passion for pumps

A well-functioning pump helps you succeed. That applies certainly to the most important pump in life, the human heart, but the same goes for pumps in business. At Verder, all energy and attention is focused on improving the quality and performance of our pumps and service. We do so with energy, dedication and most importantly, with our heart.

VERDER – PASSION FOR PUMPS



THE VERDER GROUP

- 1 Company
- 27 Countries
- >60 Years of expertise
- 5 Manufacturing companies
- Global network
- Local distributors
- In-house service & maintenance
- A solution for every application

The Verder group is a family owned business established more than 60 years ago in the Netherlands; the group consists of a worldwide network of production and distribution companies. Group companies are involved in the development and distribution of industrial and hygienic pumps, pumping systems, high-tech equipment for quality control, research and development into solid material (solids sample preparation and analytical technologies). The Verder Group employs over 1800 people and has an annual turnover close to 400 million Euros.

With the hygienic brand Packo (Centrifugal, rotary lobe and twin screw pumps), and the industrial brands Verderair (Double diaphragm) and Verderflex (Peristaltic) Verder offers a complete portfolio pumps that offers solutions all over industry.

Best expertise in broad hygienic solutions







The in-depth knowledge, ensured by the hygienic specialists of our manufacturing companies, gives us the possibility to offer you the best solution for your hygienic process. With our well-known brands Packo, Verderflex and Verderair we have a wide range of hygienic pumping programs. We have various solutions for your process line creating a long lasting, cost effective, but most of all hygienic safe pump solution.

Packo Lobe and twin screw pumps

Each series of the Packo rotary lobe and circumferential piston pumps is state-of-the-art. The pumps can be fitted with a variety of features and rotors to adapt to almost all hygienic pumping tasks. The pumps can be customized to meet the optimum function or performance to your process.

PACKO HYGIENIC PUMPS

LARGE SELECTION
BEST QUALITY
HIGHEST STANDARDS

	Rotary lobe pumps				Circumferential piston pumps	Twin screw pumps
	ZL	TP	ZW	ZLC	ZP	ZS
						
Max. flow rate [l/min]	1.670	1.141	250	1.670	708	1.660
Max. pressure [bar]	20	15	6	20	15	12
Surface roughness Ra [µm]	< 0,6	< 0,6	< 0,6	< 0,4	< 0,6	< 0,8
Rotor types	Single-Wing Bi-Wing Tri-Lobe / Bi-Lobe Heli-Lobe Multilobe	Tri-Lobe	Elastomer-Heli-Lobe	Bi-Wing Tri-Lobe Multilobe Heli-Lobe	Bi-Wing from Non-Galling stainless steel	316L screw, diffusion hardened
Connection versions	DIN 11851 Flange (ANSI / DIN) rectangular inlet SMS RJT	DIN 11851 Flange (ANSI / DIN) rectangular inlet SMS	DIN 11851 Flange (ANSI / DIN) Tri-Clamp SMS RJT	Tri-Clamp Sterile flange	DIN 11851 Flange (ANSI / DIN) Tri-Clamp SMS RJT	DIN 11851 Flange (ANSI / DIN) Tri-Clamp SMS RJT
Options	Heating jacket Relief valve Stainless steel gear housing ATEX Flushed GLRD Double-acting GLRD O-ring seal Double O-ring seal Triple lip seal	Heating jacket Relief valve ATEX Options on request	Stainless steel gear housing Double-acting GLRD Triple lip seal	1.4435 Heating jacket Relief valve Elastomers made of FKM or FFKM Stainless steel gear housing ATEX Double-acting GLRD Quench seal Knife-edge seal	Heating jacket Relief valve Stainless steel gear housing Surface roughness Ra 0.4 µm ATEX Double-acting GLRD O-ring seal Double O-ring seal Triple lip seal	ATEX Flushed GLRD Double-acting GLRD Triple lip seal
Certificates	3A Material 3.1 FDA Performance Test 1935/2004 EHEDG	3A Material 3.1 FDA Performance test 1935/2004	3A Material 3.1 FDA Performance test 1935/2004	Material 3.1 Declaration of Conformity 2.1 FDA & USP Class VI Performance Test Pressure Test Measurement of roughness depth Delta ferrite protocol (for 1.4435 only) Welding documentation, passivation & electropolishing cleaning certificate	3A Material 3.1 FDA Performance test 1935/2004 EHEDG	3A Material 3.1 FDA Performance test 1935/2004 EHEDG
Standard configuration	Stainless steel 316L Bi-wing Single-acting GLRD (SiC/SiC/EPDM) DIN 11851 connections Cast iron gear housing	316L stainless steel Tri-lobe Single-acting GLRD (SiC/SiC/EPDM) DIN 11851 connections Cast iron gear housing	316L stainless steel Elastomer heli-lobe Single-acting GLRD (SiC/SiC/EPDM) DIN 11851 connections Cast iron gear housing	316L stainless steel, electropolished base plate, e-polished bi-wing Single-acting GLRD (SiC/SiC/EPDM) Tri-clamp Cast iron gear housing	Stainless steel 316L Non-galling stainless steel bi-wing Single-acting GLRD (SiC/SiC/EPDM) DIN 11851 connections Cast iron gear housing	316L screw Single-acting GLRD (SiC/SiC/EPDM) DIN 11851 connections Stainless steel gear housing







100% TESTED BEFORE DELIVERY!

ROTORS

LARGE SELECTION
BEST QUALITY
HIGHEST STANDARDS

For rotary lobe pumps, circumferential piston pumps and twin screw pumps

The large selection of rotor types makes it possible to find the perfect fit for your application.

ROTORS							
	BI-WING SINGLE-WING	TRI LOBE	MULTI LOBE	HELI LOBE	RUBBER HELI-LOBE	BI-WING PISTON	TWIN SCREW
							
Low pulsation	O	+	+	++	++	O	+++
NPSH	O	+	+	++	++	++	++
Solids handling	++	+	O	+	+	++	++
CIP feed pump	+	+	+	+	+	+	+++
Low noise	O	O	O	+	+	O	++
Pressure	+	+	++	+	O	++	+

+++ *excellent*
++ *very good*
+ *good*
O *satisfactory*

PACKO ROTARY LOBE PUMPS

LARGE SELECTION
BEST QUALITY
HIGHEST STANDARDS

Packo's range of rotary lobe pumps includes a variety of types, each representing the state of the art in its specific application. The pumps are available in various configurations to suit your specific applications.

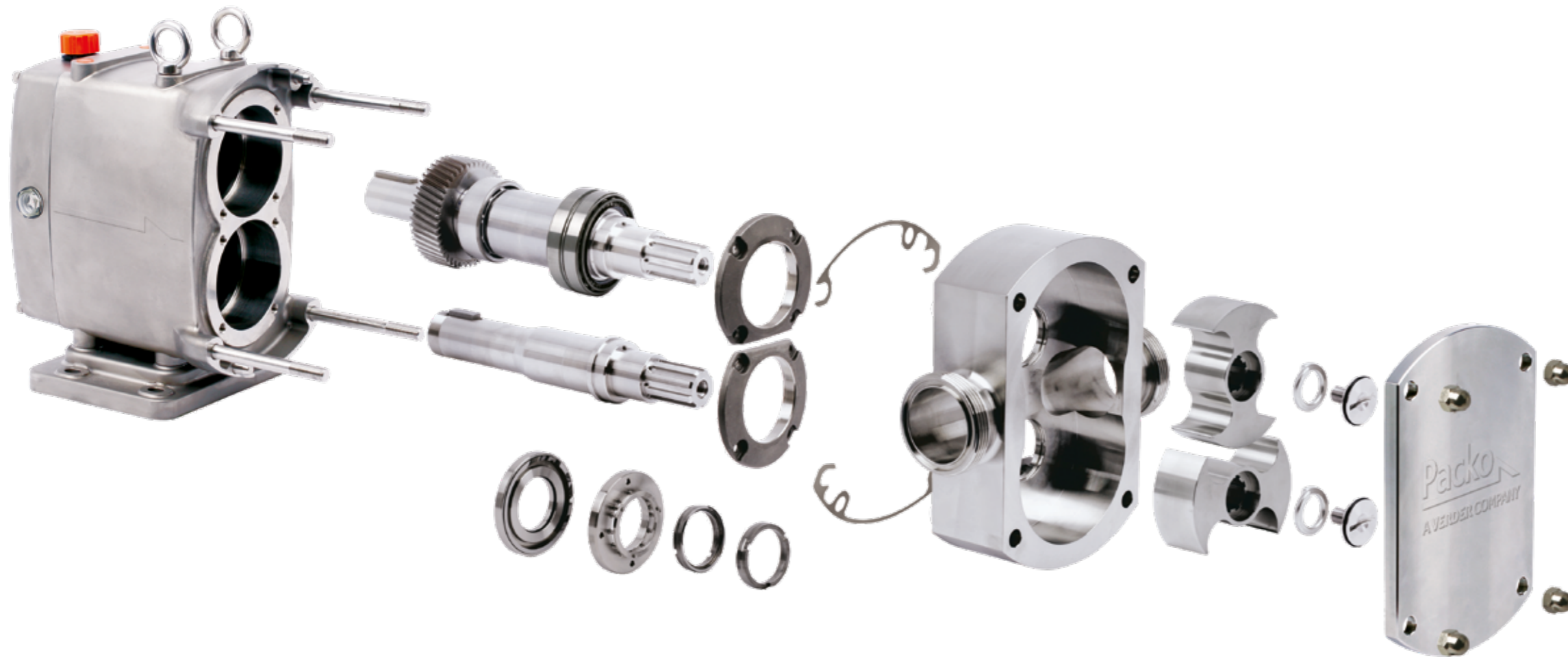

Unique Sealing concept

Front-accessible seals allow for faster maintenance, easier cleaning and shorter downtime. All sealing options, such as O-ring seals, PTFE lip seals, flushed seals, are designed for quick and easy conversion

Optimised Cleaning

Short flushing paths enable perfect CIP results.

Range of rotors & connections

The wide range of rotor types and connections makes it possible to achieve a perfect fit for the application.

Stainless steel gear housing

As an option, the gear housing can be made from precision-cast stainless steel, providing a paint-free, rust-free surface with long durability and thus increasing quality and service life.

Helical spur gearing

The high-precision helical gearing drives the rotors smoothly, even at high speeds and pressures, thus reducing vibrations and increasing both efficiency and seal service life.

Standard: 0,6 µm Ra & Stainless steel 316L

All parts in contact with fluids are made of 316L stainless steel and have a surface quality of Ra <0.6 µm or better. This meets the requirements of EHEDG, GMP and 3A.

Pharma Design available

Developed especially for applications in the pharmaceutical industry. Parts in contact with fluids are made of 316L stainless steel (optionally 1.4435), have a surface roughness of Ra <0.4 µm and are electropolished. Certificates (e.g. FDA, USP class VI, etc) are available.

ZL SERIES

LARGE SELECTION
BEST QUALITY
HIGHEST STANDARDS



- The ZL series has been developed for a wide range of applications such as dairy products, food, beverages, pharmaceuticals, cosmetics, pasta products, detergent, alcohols, the chemical industry and semiconductor manufacturing, etc. It is especially suitable for pumping liquids in the low to high-viscosity range as well as maintaining smooth flow rates.
- With a high-quality 0.6 µm surface finish and a unique seal and housing design, the ZL series is suitable for CIP and offers exceptional levels of hygiene.
- Parts in contact with fluids are made of 316L stainless steel.
- A variety of sealing options, such as mechanical seals, O-ring seals and lip seals, enable perfect adaptation to your applications.
- Optimal CIP results are ensured by the O-ring positioning, which minimises the dead space between the housing cover and pump housing.
- The wide selection of Packo rotors (single-wing, bi-wing, tri-lobe, multilobe, heli-lobe and gear) makes it possible to attain the highest level of economic operating efficiency.
- A variety of connection options are available, including SMS, RJT, DIN, ISO, tri-clamp and flanges.

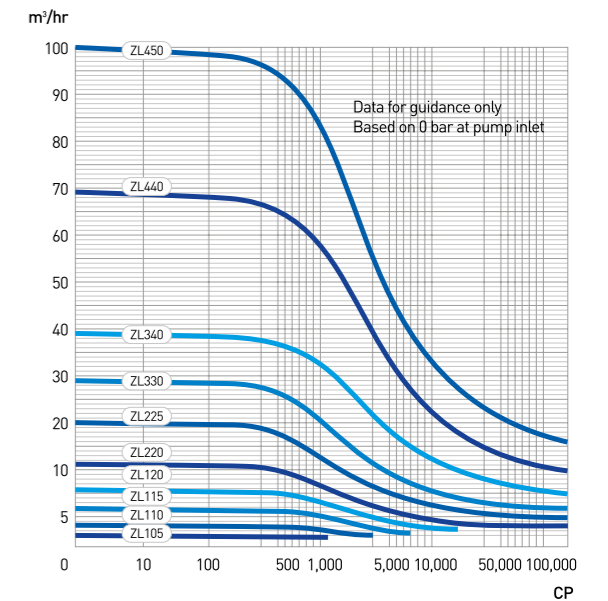

Pumps with heat jacket

Designed for products that require temperature control, such as sugar solutions, chocolate, syrup and brewer's yeast. Available for pump head cover and housing.



Rectangular inlet

An extended rectangular inlet makes it possible to pump highly viscous fluids such as semi-solid pastes or mixtures with semi-solid particles.



Relief valve

The relief valve protects the system against pressure spikes by opening a connection from the pressure side to the inlet side.

Model	Liter/rev	Max pressure (bar)	Connect ion. (mm)	Max speed (rpm)
ZL/105	0.02	20	25	1000
ZL/110	0.05	20	25	1000
ZL/115	0.12	12	38	800
ZL/120	0.21	8	50	800
ZL/220	0.40	12	50	700
ZL/225	0.62	8	63	700
ZL/330	1.02	12	76	600
ZL/340	1.44	8	100	600
ZL/440	2.27	12	100	500
ZL/450	3.34	8	125	500

PACKO ROTARY LOBE TRUCK PUMPS

LARGE SELECTION
BEST QUALITY
HIGHEST STANDARDS



TP SERIES

- The TP series has been developed for use on tankers. It provides high capacity and pressure for both low and high-viscosity fluids, enabling faster loading and unloading.
- Hygienic due to a specially profiled sealing system, Ra <0.6 µm surface finish and minimal dead space in the sealing area.
- Parts in contact with fluids are made of 316L stainless steel.
- Front-accessible seals allow for easier and faster maintenance, without having to dismantle the pump housing.
- TP pumps have a lightweight housing, high efficiency and, compared to other tanker pumps, save fuel.
- Hollow shafts enable direct-coupled SAE B or C hydraulic flange motors as an alternative to standard PTO shafts.

Model	liter/rev	Max pressure (bar)	Connection (mm)	Weight (kg)	Max speed (rpm)
TP/220	0.78	15	50	77	700
TP/230	1.07	10	76	83	700
TP/330	1.16	12	76	53	700
TP/340	1.63	8	100	60	700



PACKO WINE PUMPS

ZW SERIES

- The ZW series is especially designed for winemaking, intended to provide the winemaker with the best wine quality and maximum efficiency.
- The pump's EPDM rotors prevent it from being blocked by grape skins, pips or stems.
- Screw-shaped rotors are standard.
- The optional precision-cast stainless-steel gear housing offers a paint-free, rust-free surface with lengthy service life.
- Specially designed triple-lip seals enable faster maintenance, reliable sealing and increased seal service life.
- The ZW series is equipped with front-accessible seals certified to EHEDG and 3A standards.
- A variety of connection options are available, including SMS, RJT, DIN, ISO, Tri-Clamp and flanges.

Model	Liter/rev	Max pressure (bar)	Connection (mm)	Weight (kg)	Max speed (rpm)
ZW/120	0.31	6	50	20	1000
ZW/340	1.44	6	100	103	600

PACKO PHARMACEUTICAL PUMPS

LARGE SELECTION
BEST QUALITY
HIGHEST STANDARDS



ZLC SERIES

- The new ZLC series has been especially designed for applications in the pharmaceutical industry. All parts in contact with fluids are made of 316L stainless steel (optionally 1.4435), have surface roughness of $Ra < 0.4 \mu m$ and are electropolished to meet the stringent requirements of the industry.
- The specially adapted pump head, in combination with its vertical alignment, facilitates complete residual drainage.
- All current certificates applicable to the pharmaceutical industry are obtainable (e.g. FDA, USP class VI, material certificate 3.1, etc.).
- The wide range of rotor types and connections makes it possible to achieve the perfect fit for the application.

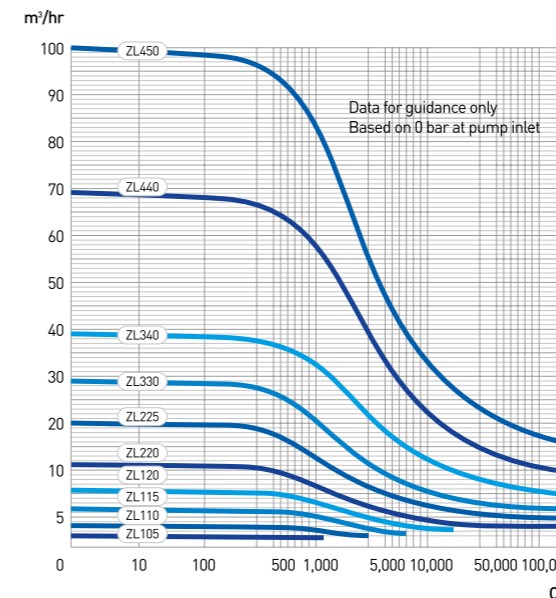

Model	Liter/rev	Max pressure (bar)	Connection (mm)	Max speed (rpm)
ZLC/105	0.02	20	25	1000
ZLC/110	0.05	20	25	1000
ZLC/115	0.12	12	38	800
ZLC/120	0.21	8	50	800
ZLC/220	0.40	12	50	700
ZLC/225	0.62	8	63	700
ZLC/330	1.02	12	76	600
ZLC/340	1.44	8	100	600
ZLC/440	2.27	12	100	500
ZLC/450	3.34	8	125	500

PACKO CIRCUMFERENTIAL PISTON PUMPS

LARGE SELECTION
BEST QUALITY
HIGHEST STANDARDS



Packo's new ZP series has been developed on the basis of Packo's proven experience and accumulated knowledge in the field of hygienic pumps. The front-accessible sealing system makes the ZP series CIP-capable and compliant with the strictest hygiene standards.

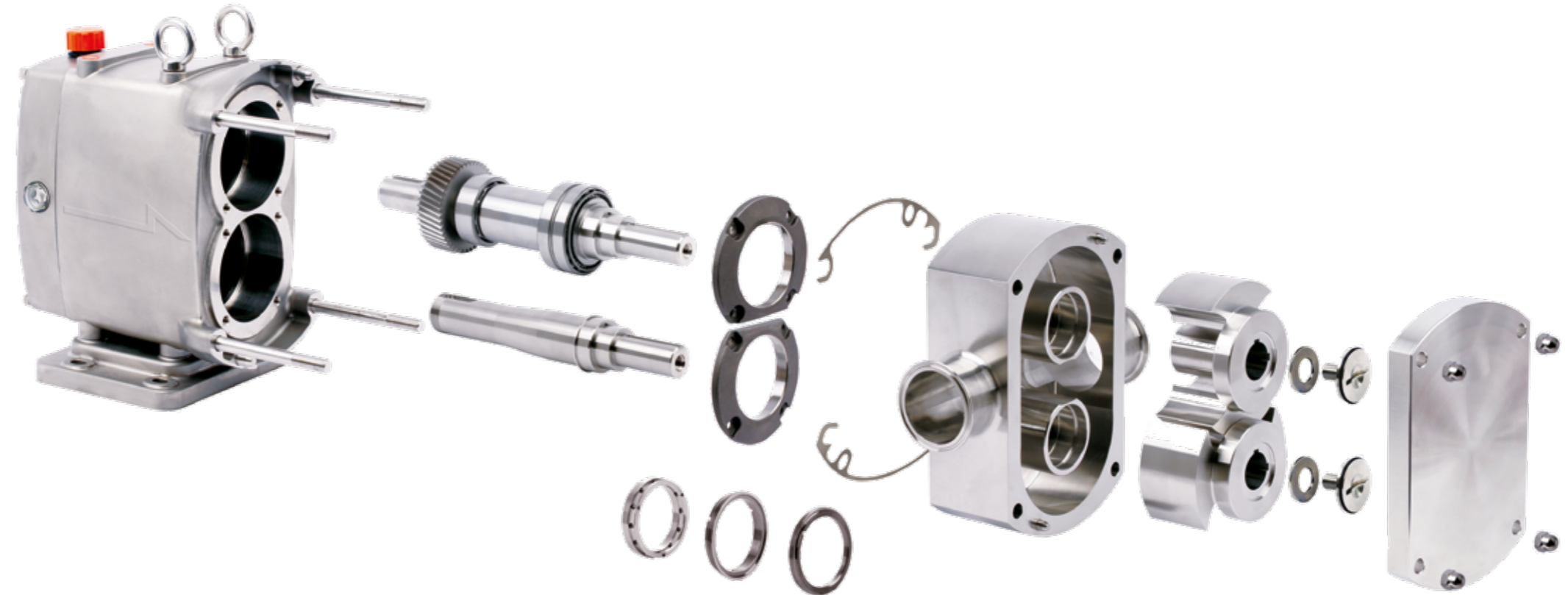

Non-Galling Stainless steel rotor

Rotors are made from nickel-based 'non-corrosive' non-galling stainless steel. The narrow gap dimensions together with the rotor geometry ensure a long sealing distance between the pump inlet and outlet. This results in low slip (optional: stainless steel rotors).

Optimised Cleaning

The front-accessible seals allow for better cleanability. In addition, they can also be replaced without having to dismantle the housing, thus reducing downtime.

Easy Adjustment

Compared to other major circumferential piston pump manufacturers, the dimensioning of the piston clearance, which is adjusted by means of stainless steel discs between the gear and housing, can be carried out effortlessly.

Stainless steel gear housing

As an option, the gear housing can be made from precision-cast stainless providing a paint-free, rust-free surface with long durability and thereby increasing quality and service life.

Helical spur gearing

The high-precision gearing with helical spurs drives rotors smoothly even at high speeds and pressures, thus reducing vibrations and increasing both pump efficiency and seal service life.

0,6 µm Ra & SS 316L Standard

All parts in contact with fluids are made of 316 L stainless steel and possess a surface quality of Ra <0.6 µm or better, thus complying with the requirements of EHEDG, GMP and 3A.

Versatile mounting options

For maximum flexibility during installation, the pump can be supplied with an upper or lower drive shaft or vertical or horizontal inlet and outlet.

ZP SERIES

LARGE SELECTION
BEST QUALITY
HIGHEST STANDARDS



- The ZP series is hydraulically and dimensionally comparable to the Waukesha U2 series.
- The compact sealing system results in a shorter shaft overhang compared to other well-known circumferential piston pump manufacturers. It is a key feature that enables quiet operation, even at high pressure.
- A variety of sealing options allow for rapid adaptation to changing operating conditions, including mechanical seals, lip seals and O-ring seals.
- Two keys on each rotor enable smooth operation at high output pressure or external vibration.
- The oil-bath lubrication is more efficient than grease lubrication.
- A variety of connection options are available, including SMS, RJT, DIN, ISO, Tri-Clamp and flanges.
- A heating jacket is available for the front housing cover and pump housing.

Model	Liter/rev	Max pressure (bar)	Connection (mm)	Max speed (rpm)
ZP/015	0.063	15	38	800
ZP/018	0.12	12	38	800
ZP/030	0.26	10	50	700
ZP/060	0.74	15	63	600
ZP/130	1.18	08	76	600



TWIN SCREW PUMPS

LARGE SELECTION
BEST QUALITY
HIGHEST STANDARDS

Packo's ZS twin screw pumps are the result of years of experience with hygienic processes as well as the lobe and centrifugal pumps used in them. For this reason, these pumps have a unique design that offers a number of advantages over conventional twin screw pumps.



Optimised housing

The housing has large radii, which means that there are no dead spaces at the pump outlet. This greatly benefits both operation (smoother flow rates) and cleaning.

Quick and easy maintenance

The sealing system allows seals to be changed from the front without having to remove the pump from the system. The design enables faster and easier maintenance.

High energy efficiency

The ZS gear assembly contains double angular ball bearings, which allow high speeds with lower heat development. This design is already used successfully in our rotary lobe pumps.

Integrated gear adapter

We offer an optional version consisting of an integrated gear adapter, which is directly coupled to a 4-pole IEC motor, type B5. The size and higher efficiency of the 4-pole motor offer an extremely compact and cost-effective solution.

2-in-1 and careful operation

The wide speed range of these pumps provides a high degree of flexibility, allowing process tasks and CIP tasks to be realised with the same pump. Pulsation free pumping ensures gentle operation.

Perfect for CIP and SIP

The ZS series is fully certified to 3A and EHDG standards and has excellent CIP and SIP characteristics.

ZS SERIES

Unique – Smart – Innovative!

Packo has combined its lengthy experience in rotary lobe and centrifugal pumps to develop a range of twin screw pumps, which combine the benefits of both products.

LARGE SELECTION
BEST QUALITY
HIGHEST STANDARDS



- The ZS series pumps are designed for a wide variety of hygienic pumping applications in the food, dairy, beverage, cosmetics, pharmaceutical and chemical industries.
- 2-in-1 operation: watery and high-viscosity fluids (up to 1,000,000 mPas), up to 3000 rpm (e.g. for CIP), up to 16 bar max. differential pressure
- The unique design (housing with large radii) prevents dead spaces on the pressure side, thus ensuring smoother flow rates and better cleanability.
- More compact than conventional pumps due to the special shaft sealing system which ensures quick and easy maintenance.
- Reduced heat development at high speeds thanks to double angular ball bearings.
- Fully certified to 3A and EHEDG standards; excellent CIP/SIP characteristics.
- The screw is diffusion hardened as standard for better wear resistance and an increased service life.

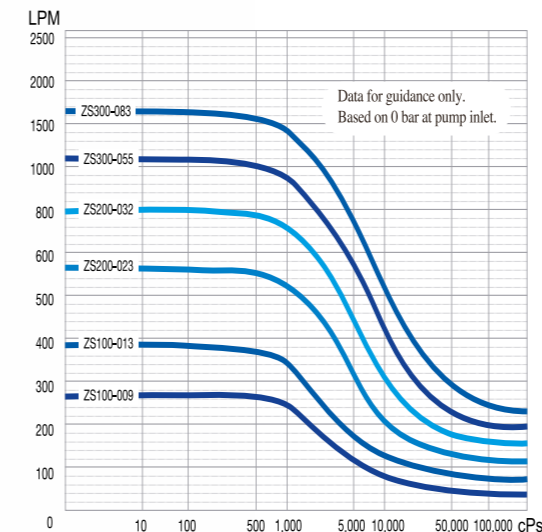

Model	liter/rev	Max pressure (bar)	Connection (mm)	Max speed (rpm)
ZS/106	0,06	12	50x38	3.000
ZS/113	0,13	8	63x50	3.000
ZS/223	0,23	12	63x50	2.500
ZS/232	0,32	8	76x63	2.500
ZS/355	0,55	12	76x63	2.000
ZS/383	0,83	8	100x76	2.000



PA-21_Overview_Packo_lobe_pumps_rev01_UK_(int)

VERDER
passion for pumps

VERDER LIQUIDS BV

Utrechtseweg 4A

3451 GG Vleuten

The Netherlands

MAIL info@verderliquids.com

WEB www.verderliquids.com

**AUSTRIA / BELGIUM / BULGARIA / CHINA / CZECH REPUBLIC
FRANCE / GERMANY / HUNGARY / INDIA / ITALY / THE NETHERLANDS
POLAND / REPUBLIC OF KOREA / ROMANIA / SLOVAKIA / SOUTH AFRICA
SWITZERLAND / UNITED KINGDOM / UNITED STATES OF AMERICA**