

SPECIFICATIONS:

MODEL NUMBER: 8000-543-138

PUMP DESIGN: Positive Displacement 3 Chamber Diaphragm Pump

CHECK VALVE: (1-Way Operation) Prevents Reverse Flow

CAM: 3.0 Degree

MOTOR: Permanent Magnet, P/N 11-111-00

VOLTAGE: 12 VDC Nominal

PRESSURE SWITCH: Adjustable Shut-Off (Range 80-100 PSI)

Factory Set @100 PSI, Turn On 85 PSI \pm 5 PSI

LIQUID TEMPERATURE: 170 Degrees Fahrenheit (77 Degrees Centigrade) Max.

PRIME: Self-Priming Up To 10 Ft. Vertical,
Max. Inlet Pressure 30 PSI (2.1 Bar)

PORTS: 3/8"-18 NPT Female

MATERIAL OF CONSTRUCTION:

PLASTICS- Polypropylene

VALVES- Viton

DIAPHRAGM- Santoprene

FASTENERS- Zinc Plated Steel

NET WEIGHT: 4.7 Lbs (2.13 Kg)

DUTY CYCLE: Intermittent (See Temperature Rise Chart)

TYPICAL APPLICATIONS: Agricultural Spraying

DIMENSIONS:

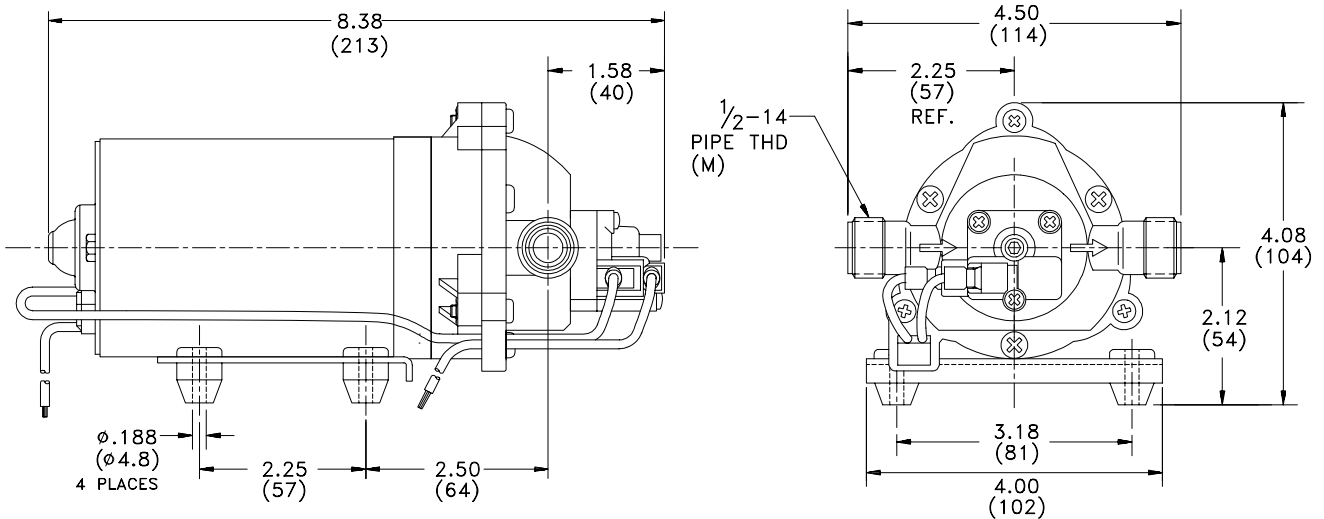

TEMPERATURE RISE

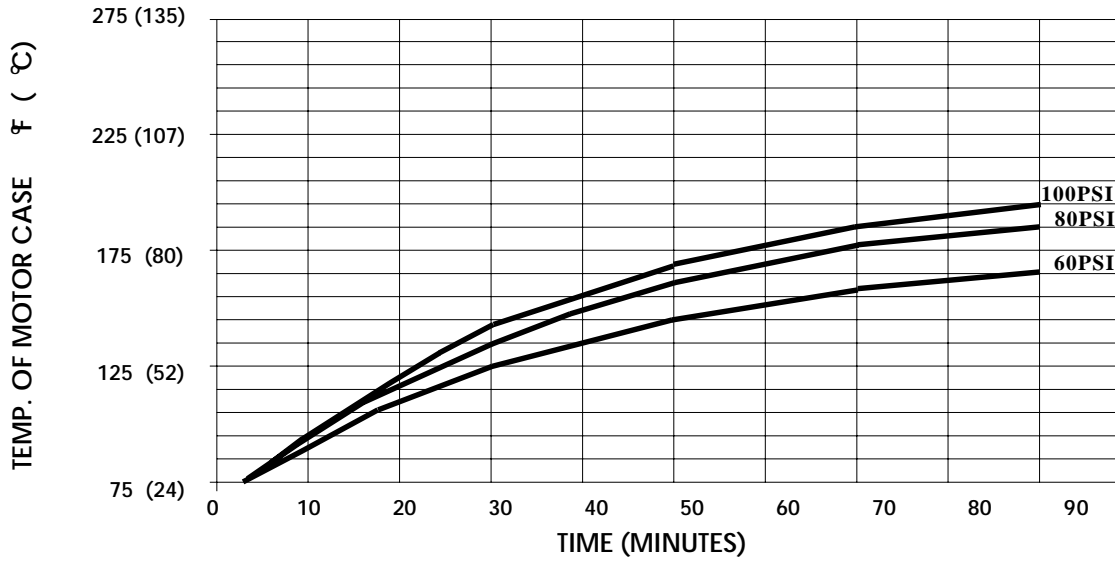

THIS GRAPH IS FOR USE AS A DESIGN GUIDE. IT IS BASED ON RUNNING CONTINUOUSLY WITH AN AMBIENT TEMPERATURE OF 70° F IN STILL AIR.

TYPICAL PERFORMANCE

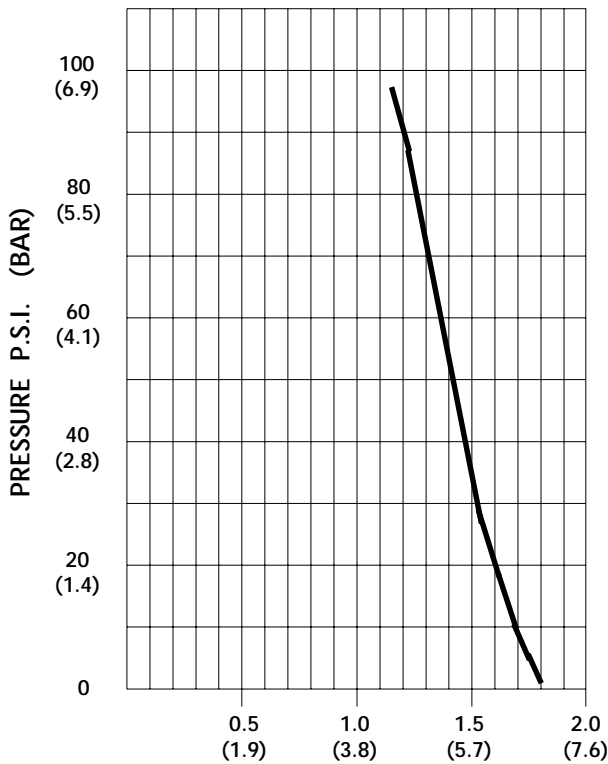

PRESSURE (PSI)	FLOW (GPM/LIT)	RPM MIN/MAX	CURRENT (AMPS)	VOLTAGE (VOLTS)
OPEN	1.8/6.8	2206/2660	3.0	12VDC
10	1.52/5.8	2170/2635	3.6	"
20	1.45/5.5	2130/2590	4.2	"
30	1.36/5.1	2090/2540	4.9	"
40	1.31/5.0	2060/2495	5.5	"
50	1.26/4.8	2030/2440	6.0	"
60	1.22/4.6	2005/2380	6.5	"
70	1.16/4.4	1980/2350	7.1	"
80	1.11/4.2	1940/2330	7.6	"
90	1.03/3.9	1915/2260	8.3	"
100	0.96/3.6	1900/2225	8.7	"

FLOW - GALLONS PER MINUTE (LITERS PER MINUTE)

-SPECIFICATIONS SUBJECT TO CHANGE WITHOUT NOTICE.

-ALL DATA BASED ON TESTING WITH WATER.