

Performance Curves

1750 RPM

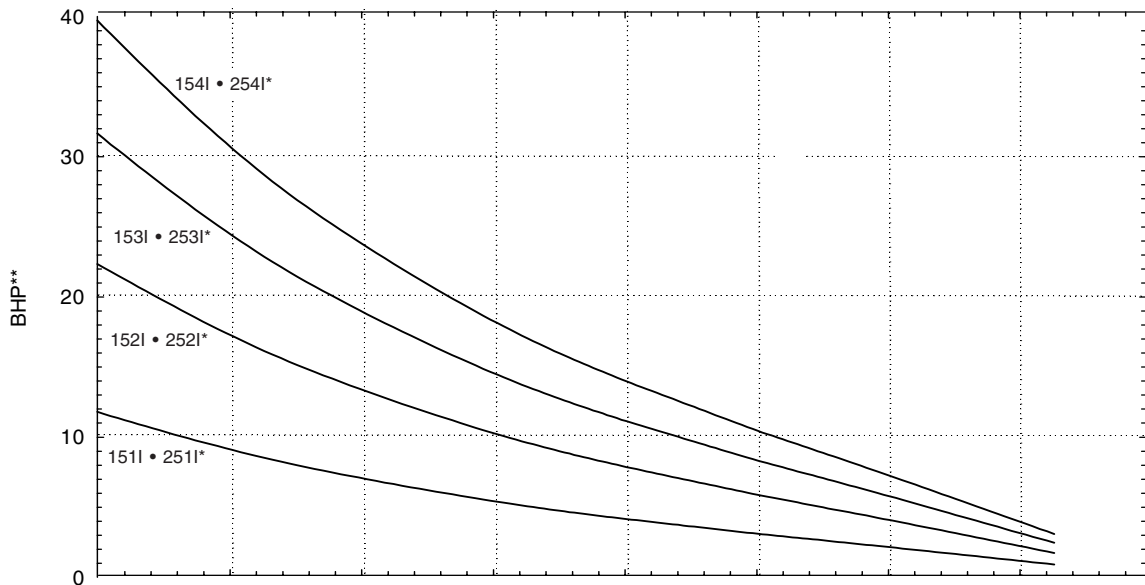
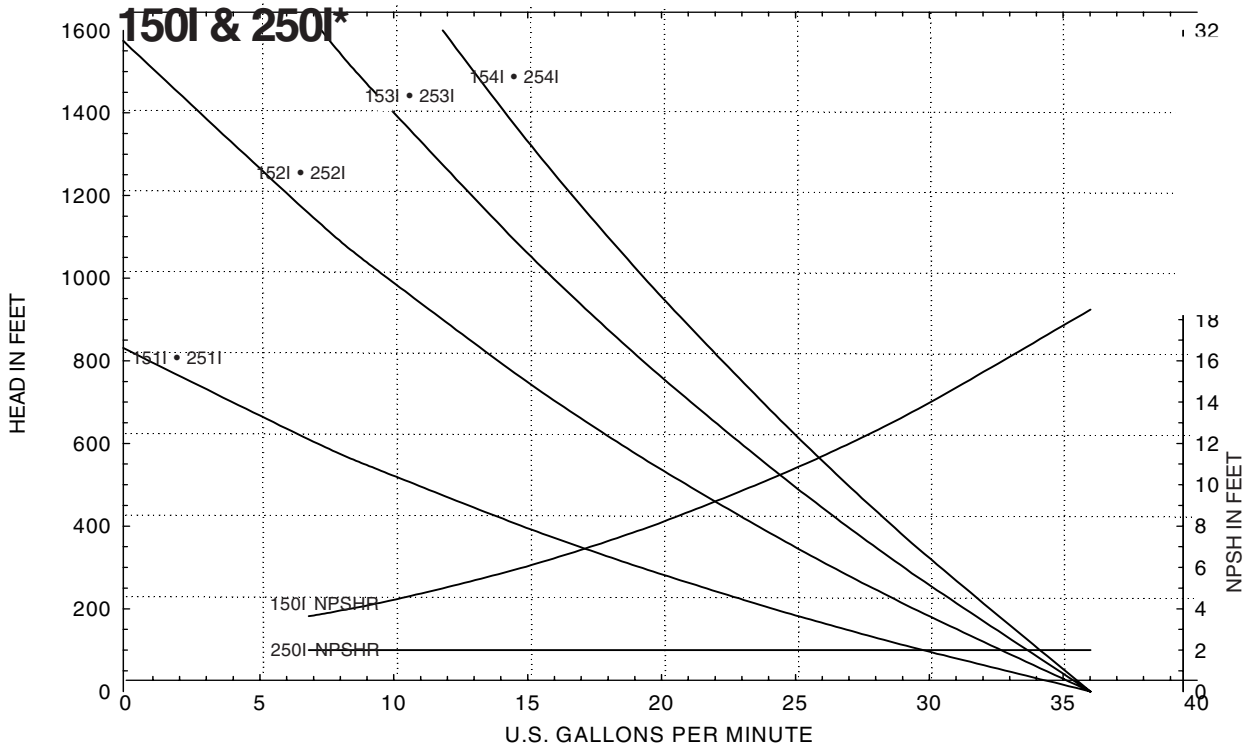

NOTES

Do not exceed 150 feet TDH with 1.0 S.G. fluids
 Consult factory for operation below 4.0 GPM
 *Add 1 horsepower for 250 Series models
 **Horsepower is valid for 1.0 specific gravity fluids only

MTH PUMPS
 401 WEST MAIN STREET • PLANO, IL 60545-1436
 PHONE: 630-552-4115 • FAX: 630-552-3688



Performance Curves

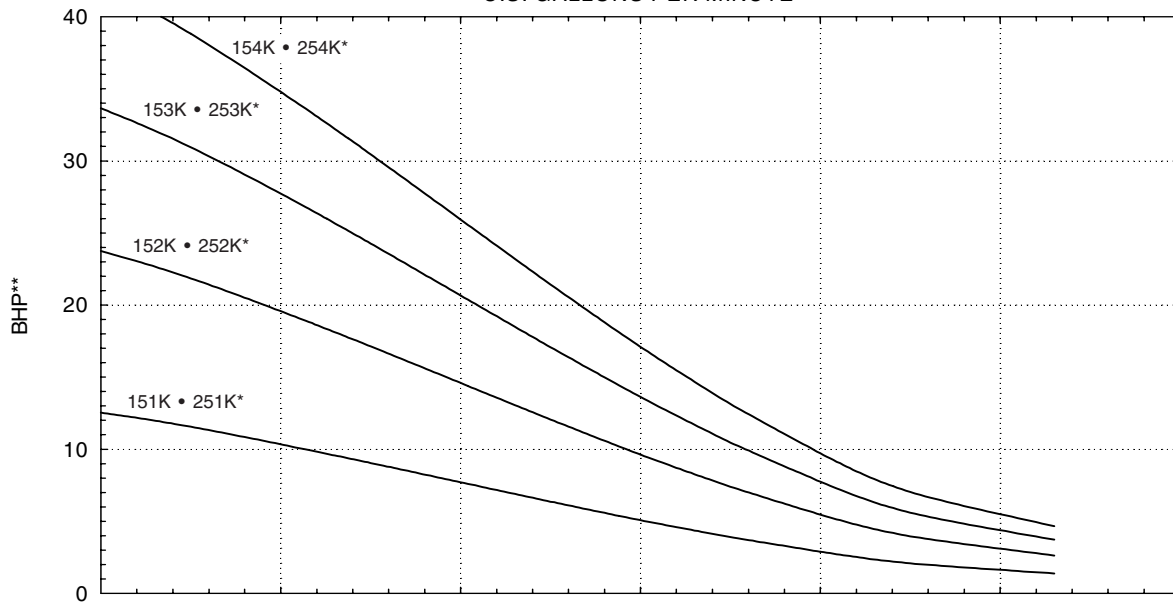
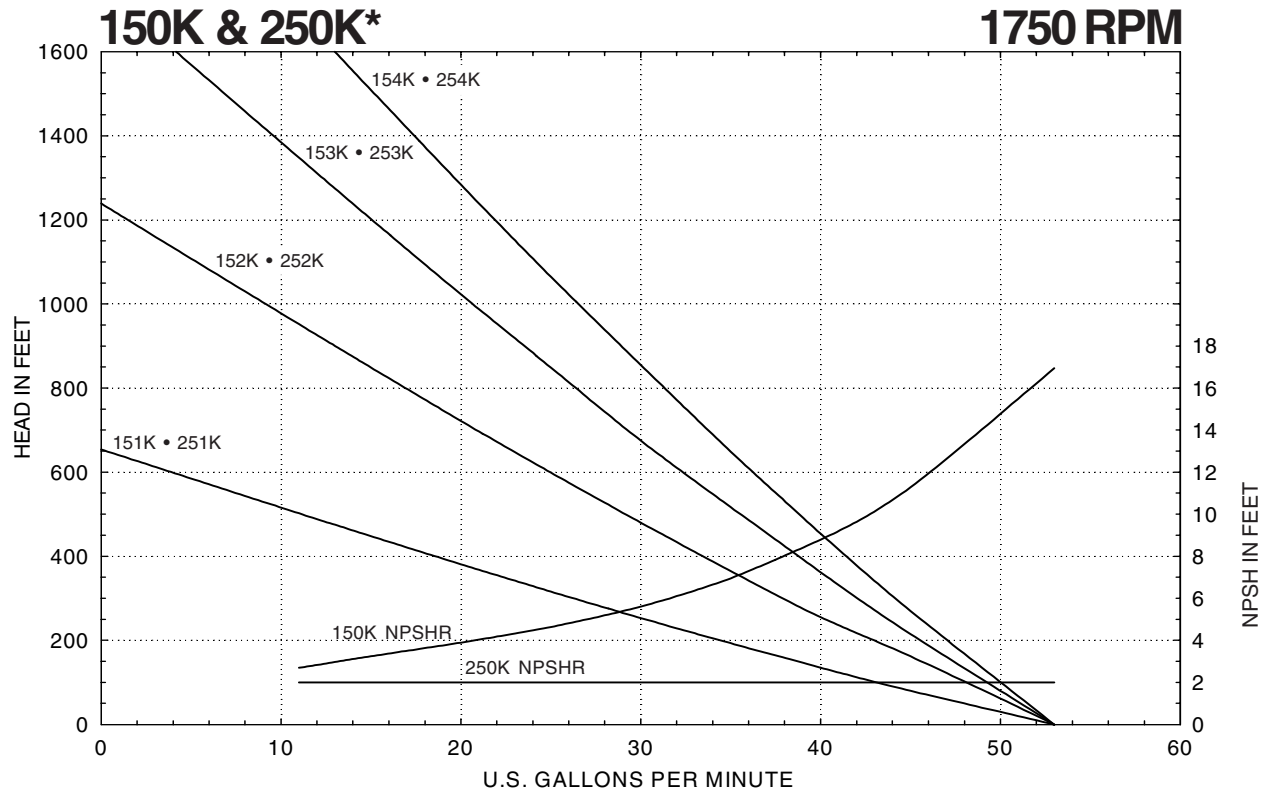

NOTES

Do not exceed 1150 feet TDH with 1.0 S.G. fluids
 Consult factory for operation below 21.0 GPM
 *Add 1 horsepower for 250 Series models
 **Horsepower is valid for 1.0 specific gravity fluids only



401 WEST MAIN STREET • PLANO, IL 60545-1436
 PHONE: 630-552-4115 • FAX: 630-552-3688

Performance Curves

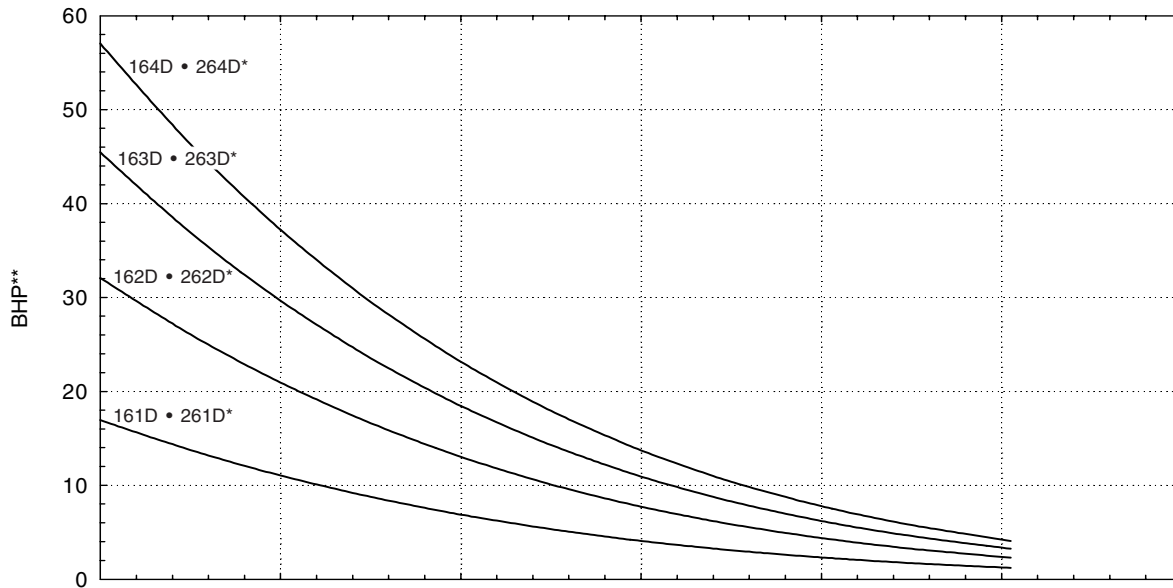
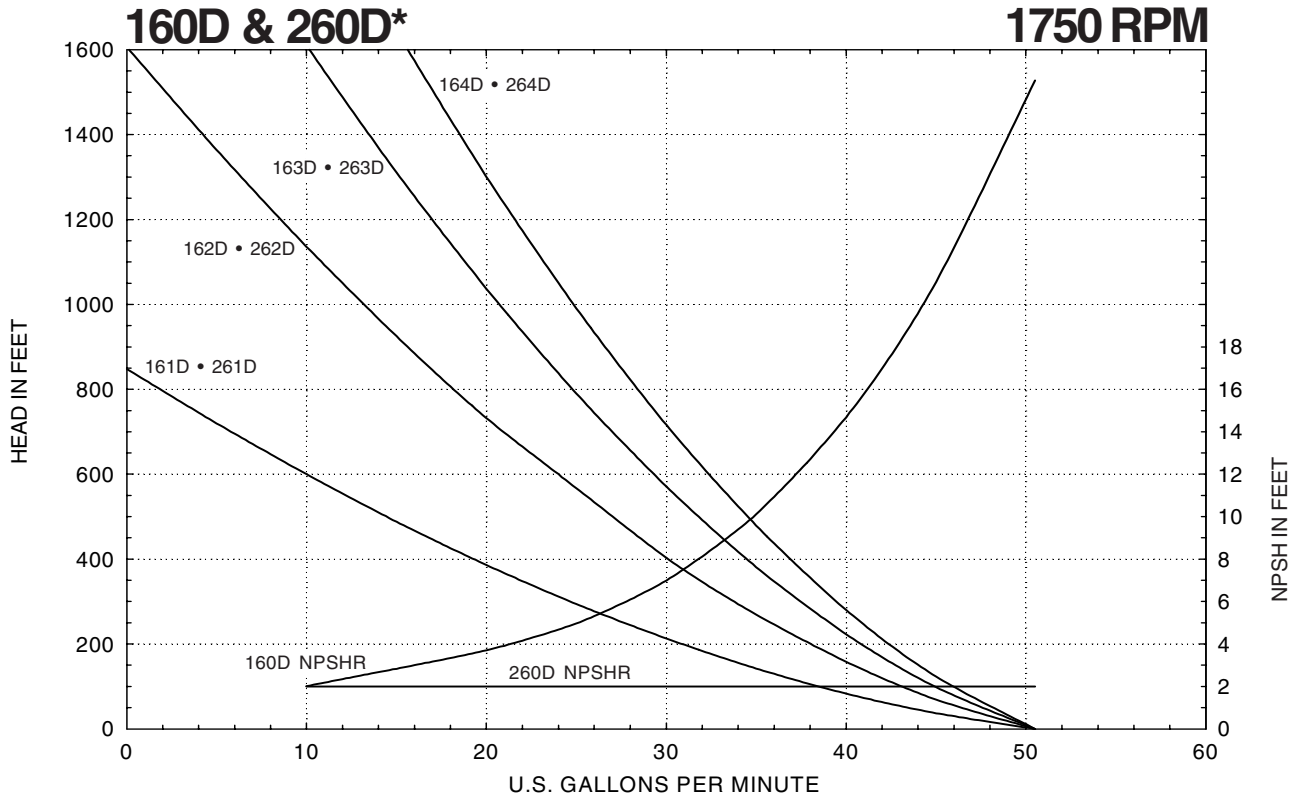

NOTES

Do not exceed 1150 feet TDH with 1.0 S.G. fluids
 Consult factory for operation below 20.0 GPM
 *Add 1 horsepower for 260 Series models
 **Horsepower is valid for 1.0 specific gravity fluids only

Performance Curves

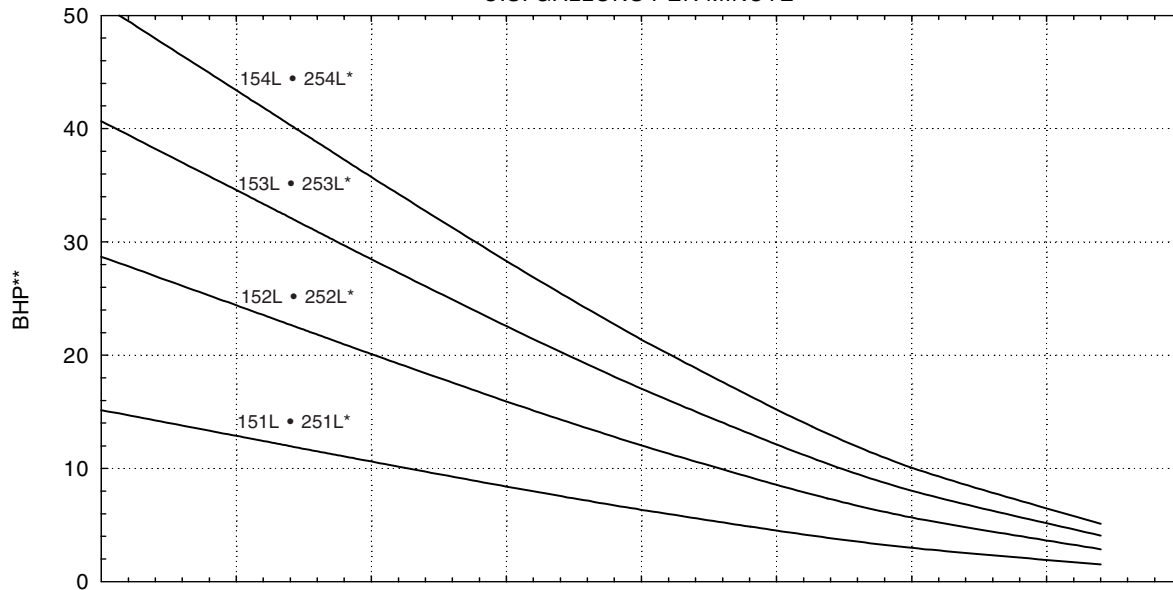
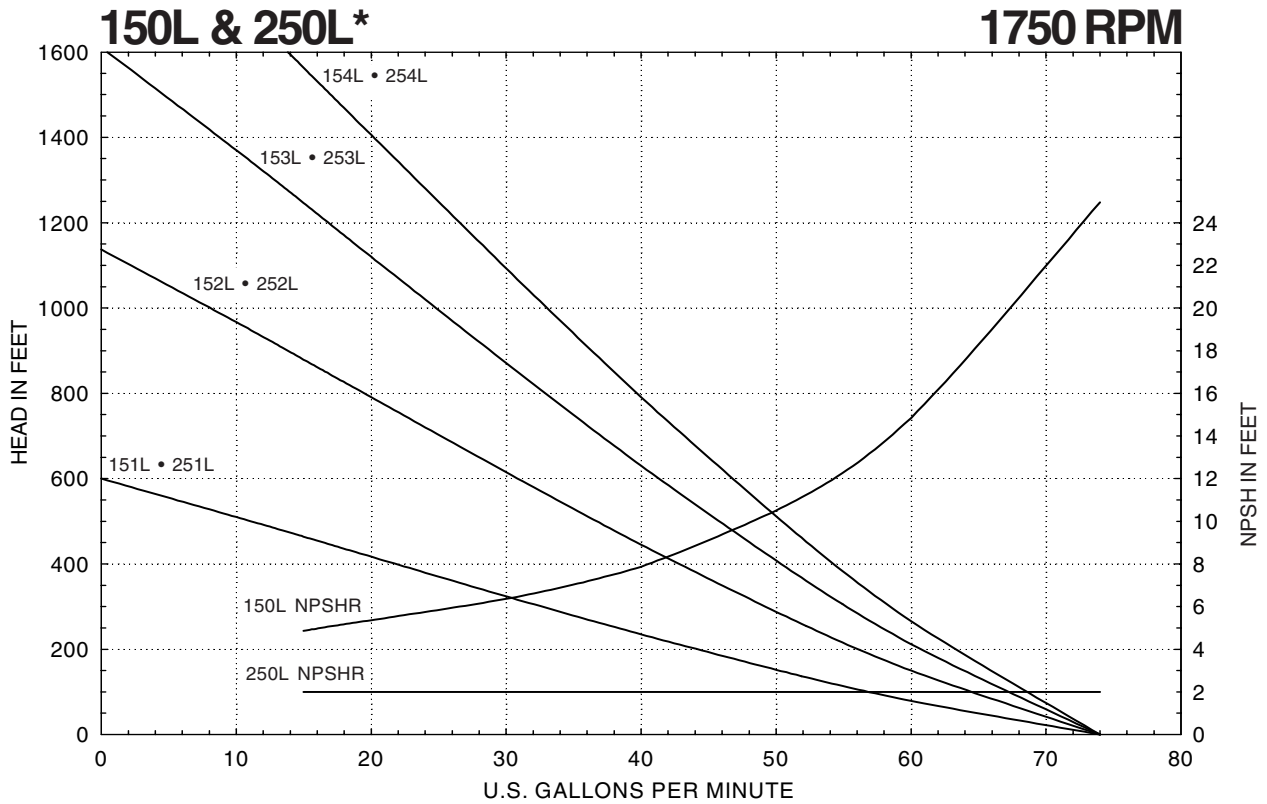

NOTES

Do not exceed 1150 feet TDH with 1.0 S.G. fluids
 Consult factory for operation below 29.0 GPM
 *Add 1 horsepower for 250 Series models
 **Horsepower is valid for 1.0 specific gravity fluids only

NOTES

Do not exceed 1150 feet TDH with 1.0 S.G. fluids
 Consult factory for operation below 29.0 GPM
 *Add 1 horsepower for 250 Series models
 **Horsepower is valid for 1.0 specific gravity fluids only

Performance Curves

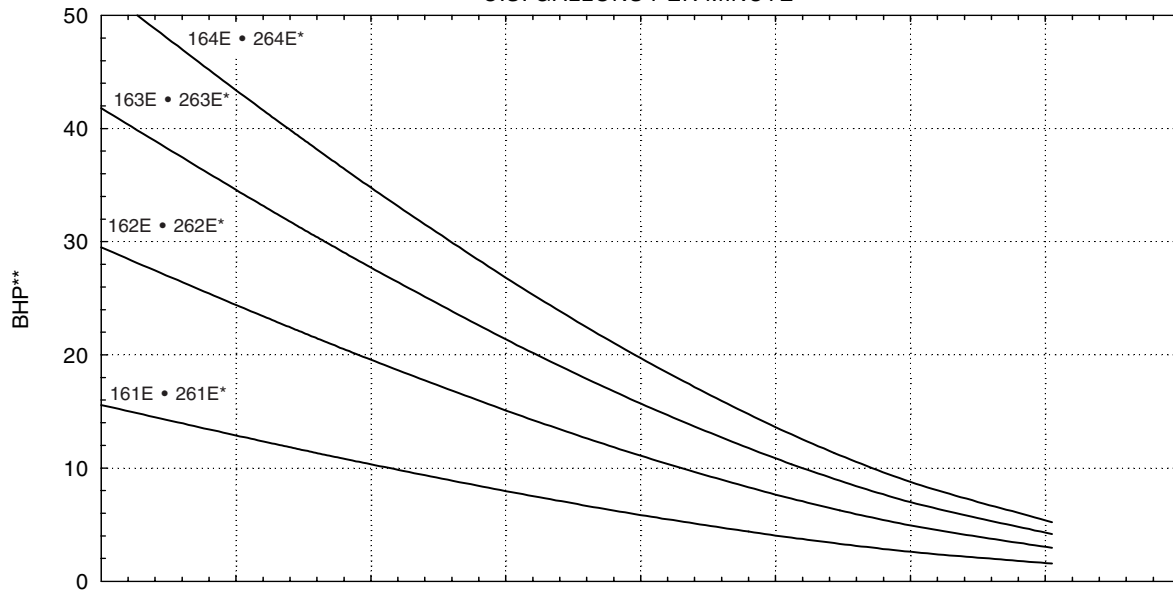
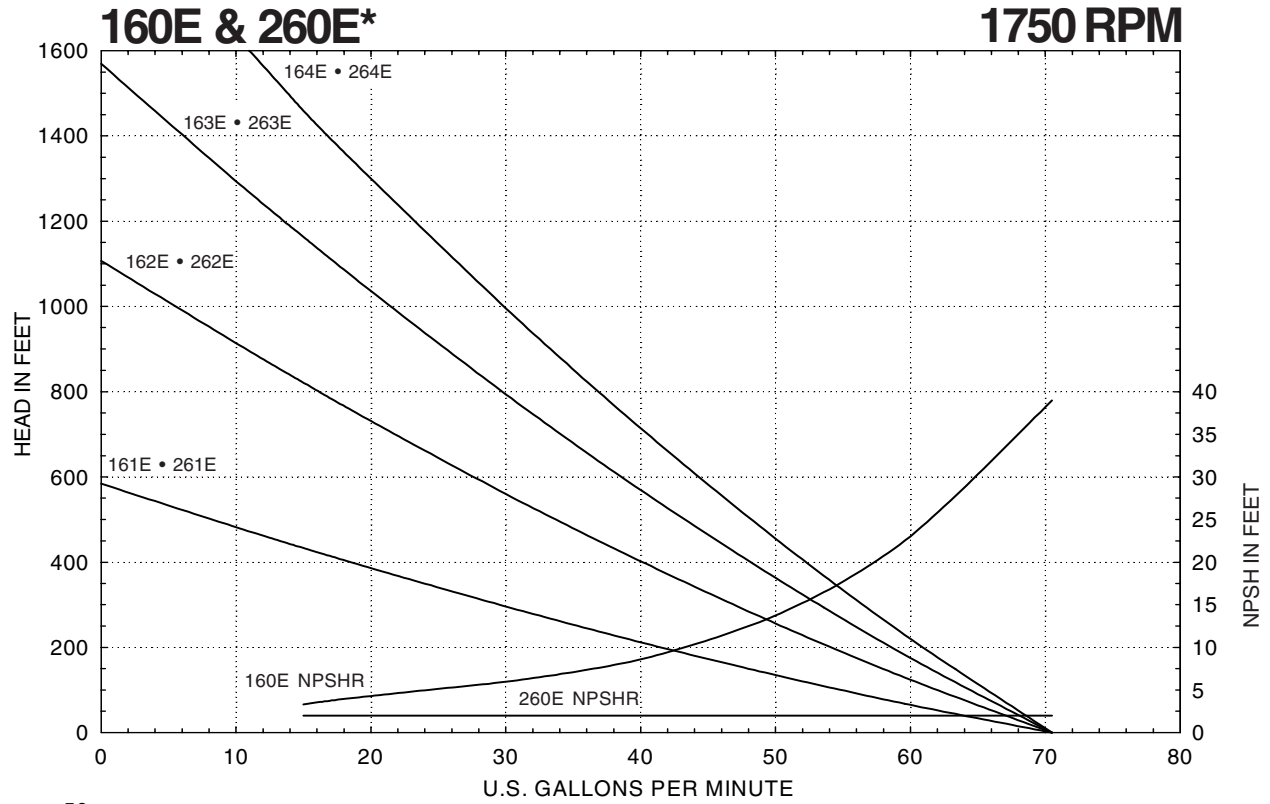

NOTES

Do not exceed 1150 feet TDH with 1.0 S.G. fluids
 Consult factory for operation below 28.0 GPM
 *Add 1 horsepower for 260 Series models
 **Horsepower is valid for 1.0 specific gravity fluids only

Performance Curves

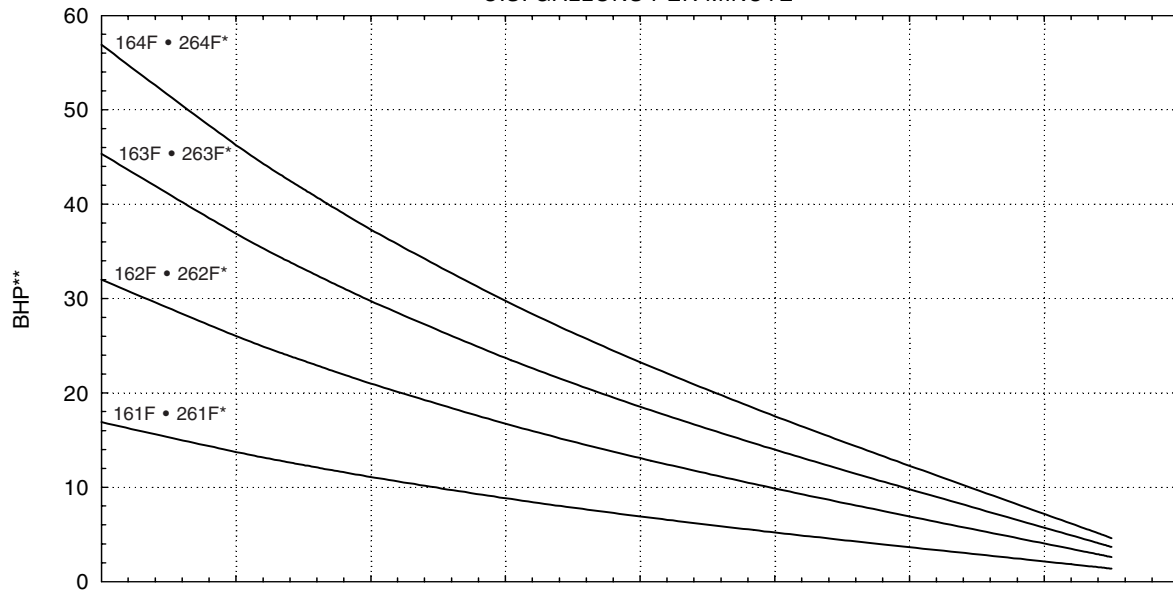
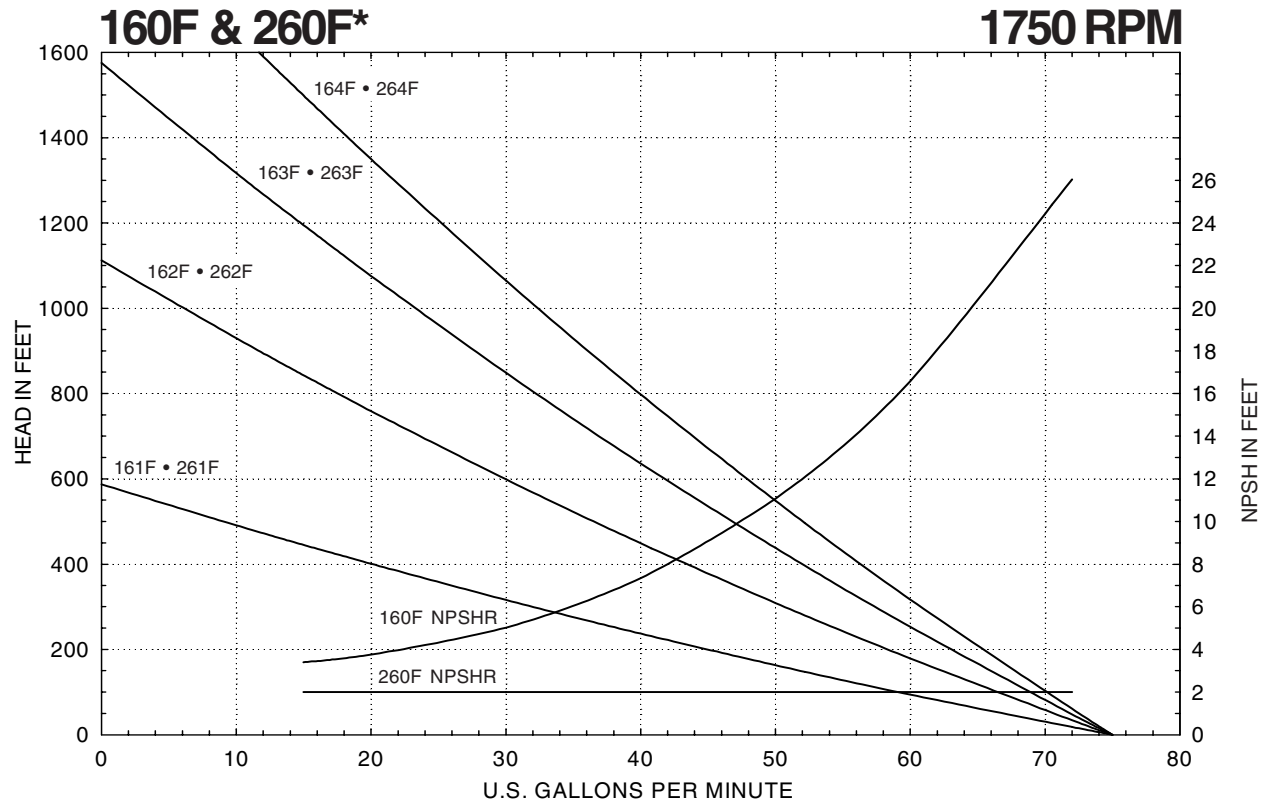

NOTES

Do not exceed 1150 feet TDH with 1.0 S.G. fluids
 Consult factory for operation below 29.0 GPM
 *Add 1 horsepower for 260 Series models
 **Horsepower is valid for 1.0 specific gravity fluids only

Performance Curves

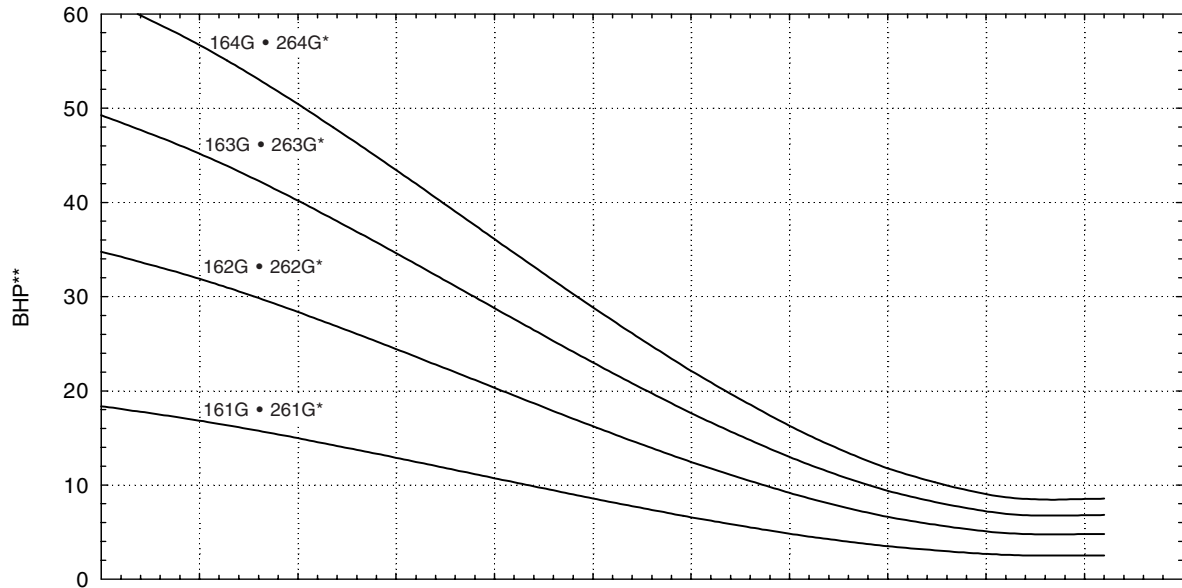
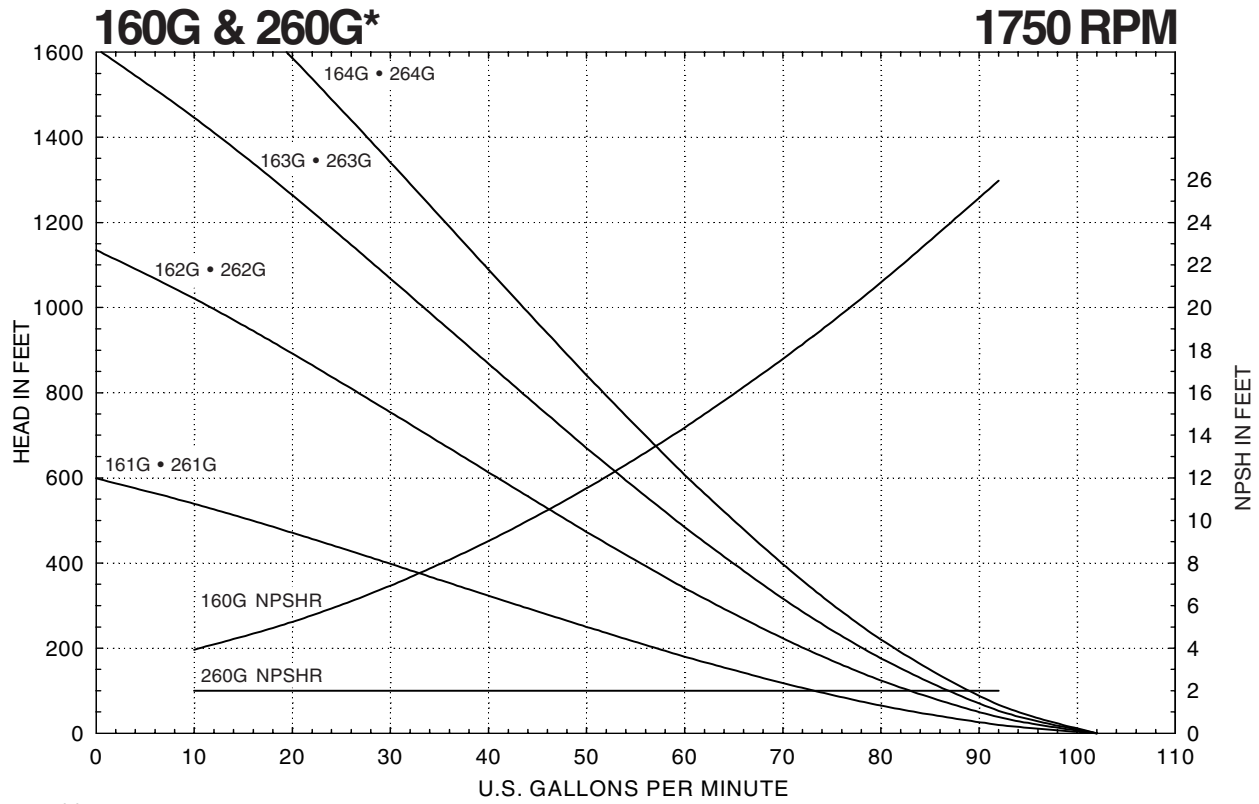

NOTES

Do not exceed 1150 feet TDH with 1.0 S.G. fluids
 Consult factory for operation below 40.0 GPM
 *Add 1 horsepower for 260 Series models
 **Horsepower is valid for 1.0 specific gravity fluids only

Performance Curves

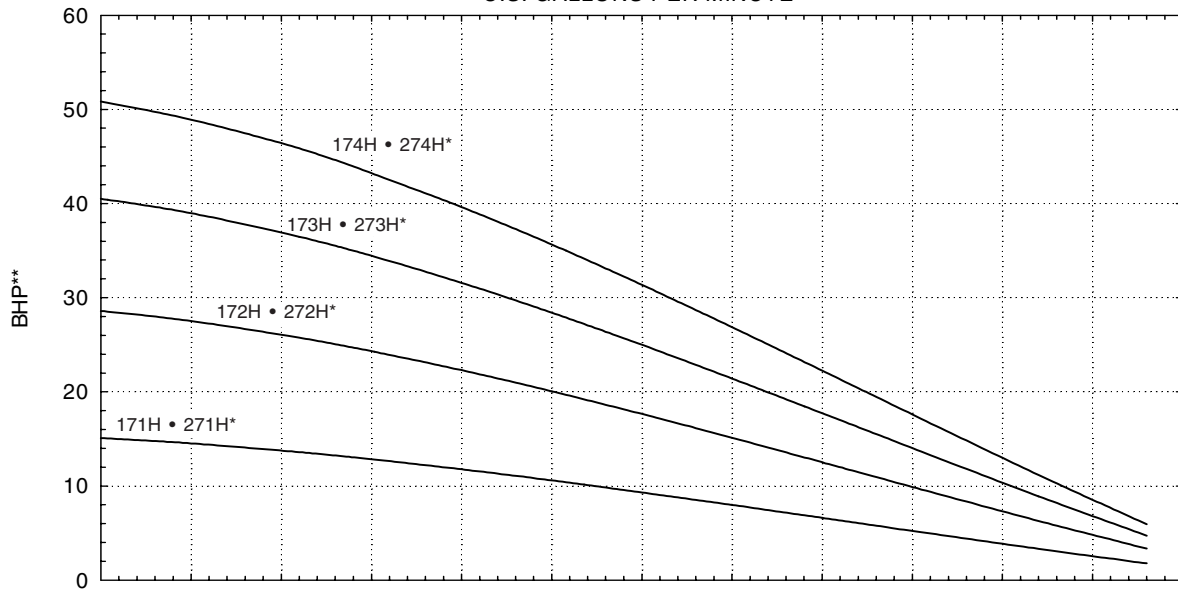
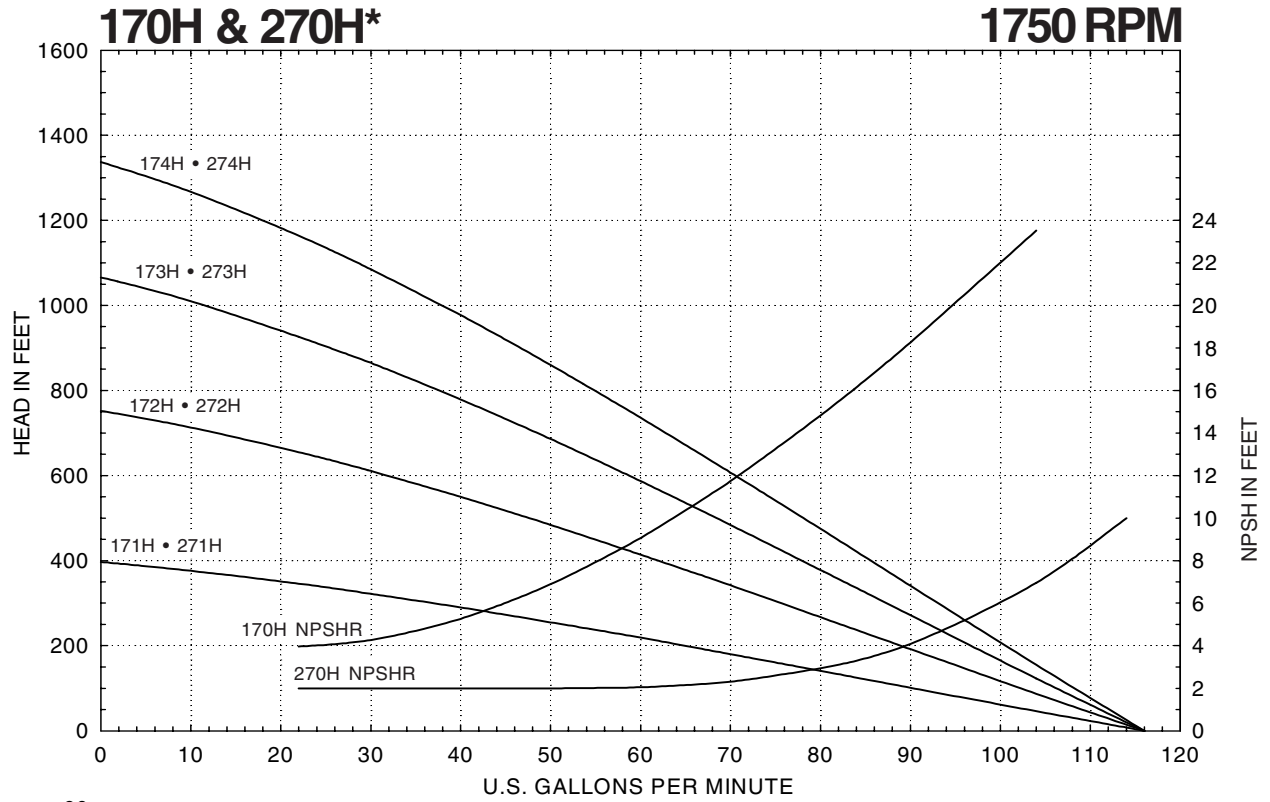

NOTES

Do not exceed 1150 feet TDH with 1.0 S.G. fluids
 Consult factory for operation below 46.0 GPM
 *Add 1 horsepower for 270 Series models
 **Horsepower is valid for 1.0 specific gravity fluids only

Performance Curves

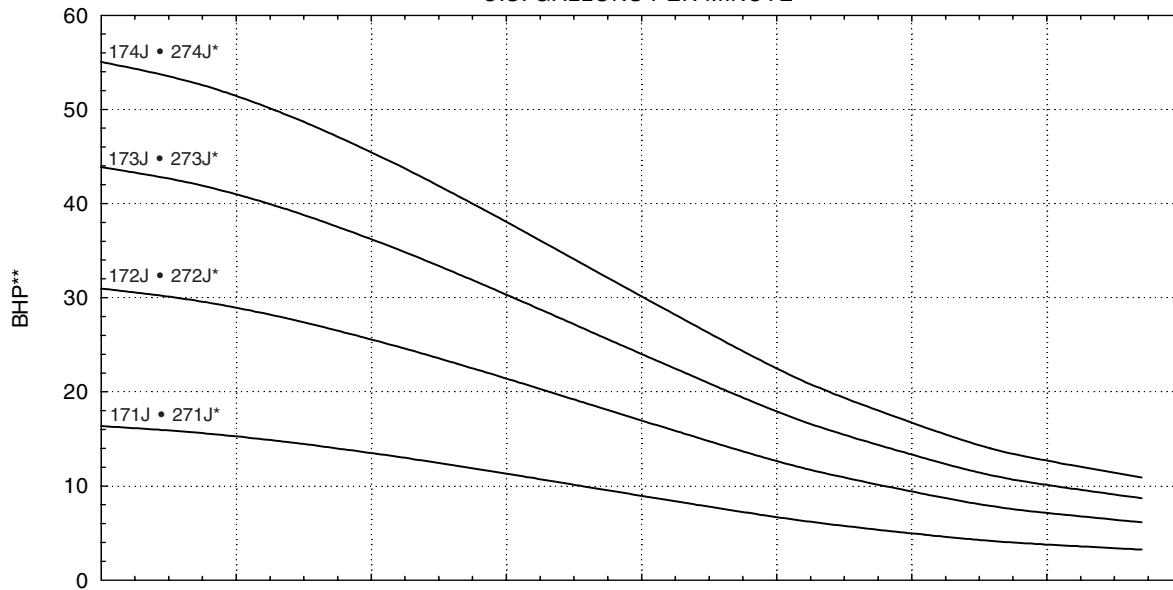
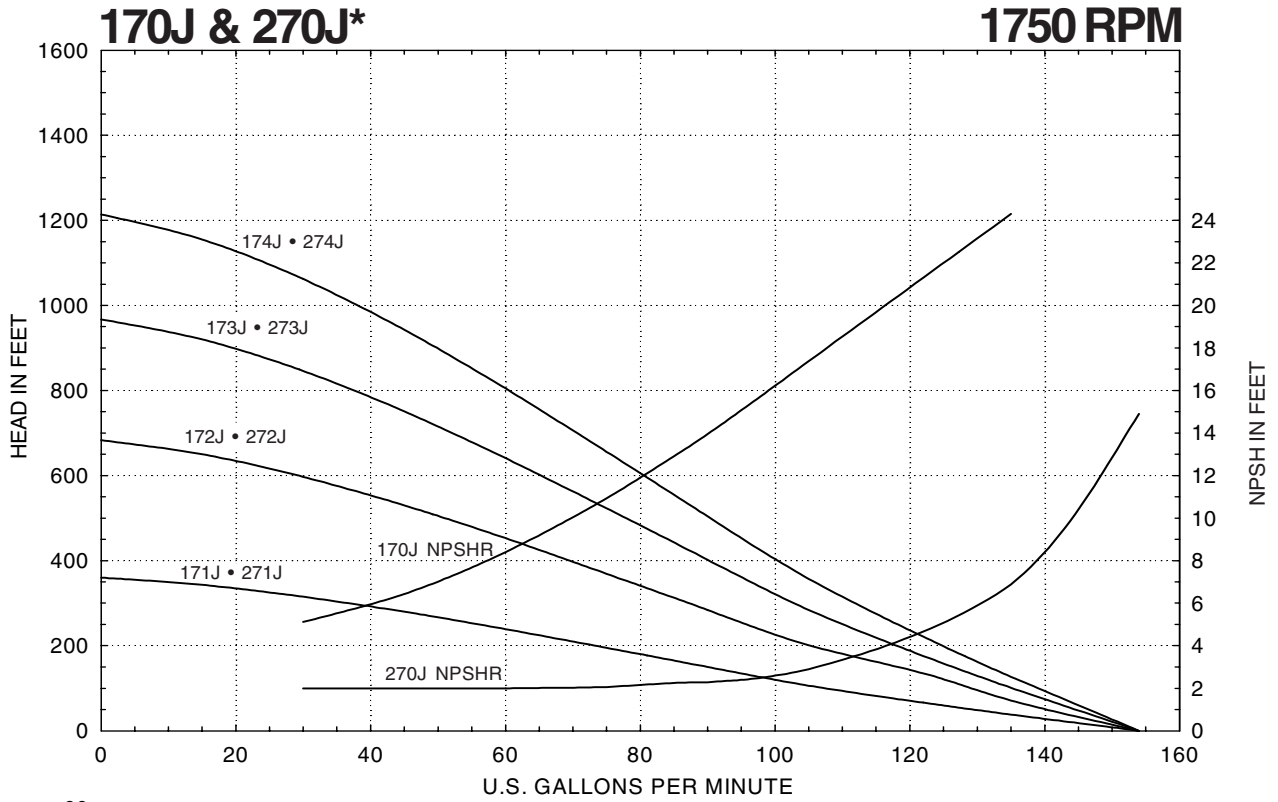

NOTES

Do not exceed 1150 feet TDH with 1.0 S.G. fluids
 Consult factory for operation below 62.0 GPM
 *Add 1 horsepower for 270 Series models
 **Horsepower is valid for 1.0 specific gravity fluids only

Performance Curves

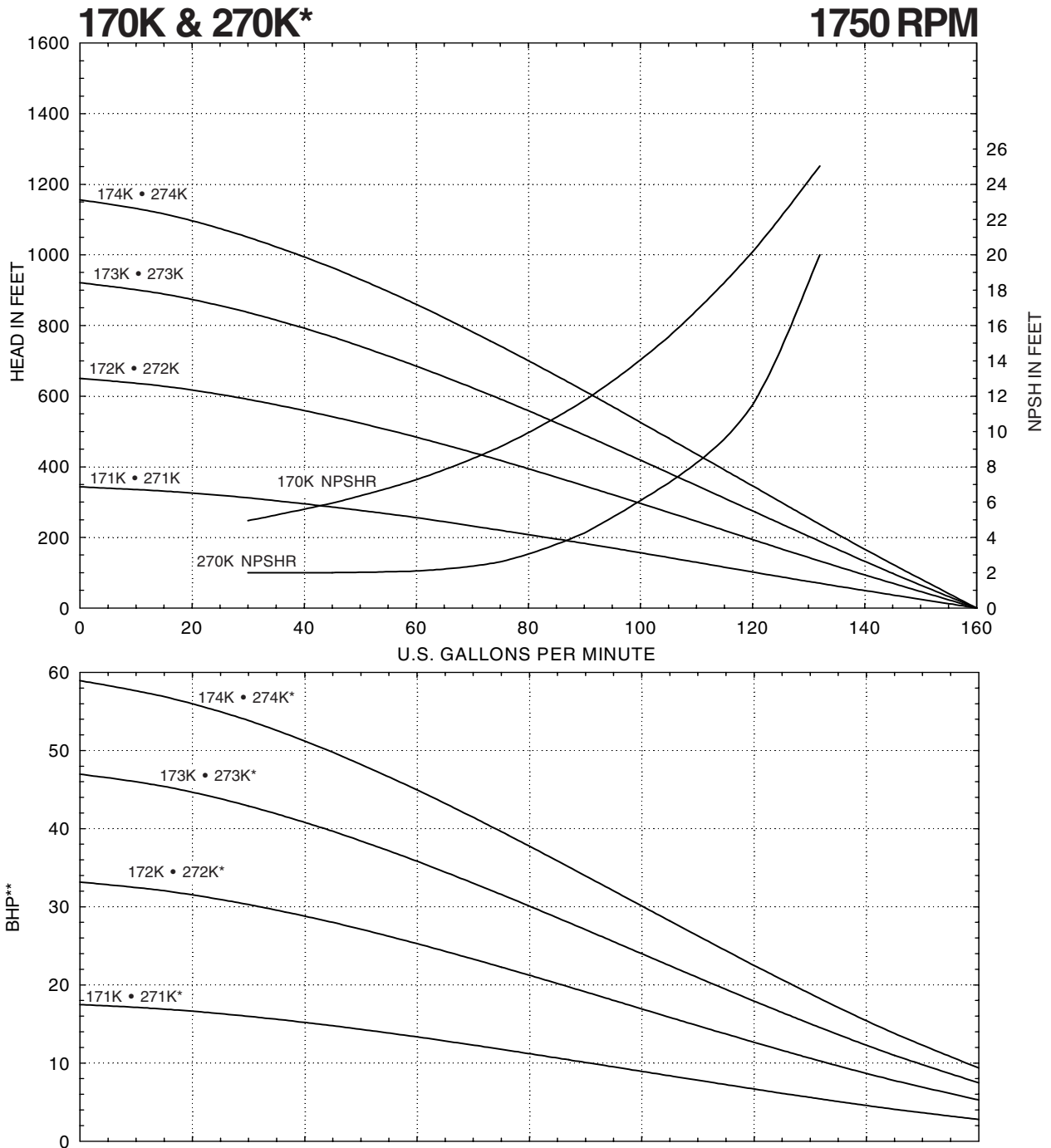

NOTES

Do not exceed 1150 feet TDH with 1.0 S.G. fluids
 Consult factory for operation below 64.0 GPM
 *Add 1 horsepower for 270 Series models
 **Horsepower is valid for 1.0 specific gravity fluids only