

**PAR™**

ELECTRIC WATER SYSTEM PUMPS

# MODEL 36800-Series 36850-Series 36900-Series 36905-Series

AUTOMATIC MULTI-FIXTURE  
PRODUCT DATA

MODEL 36800-SERIES  
36850-SERIES  
36900-SERIES  
36905-SERIES

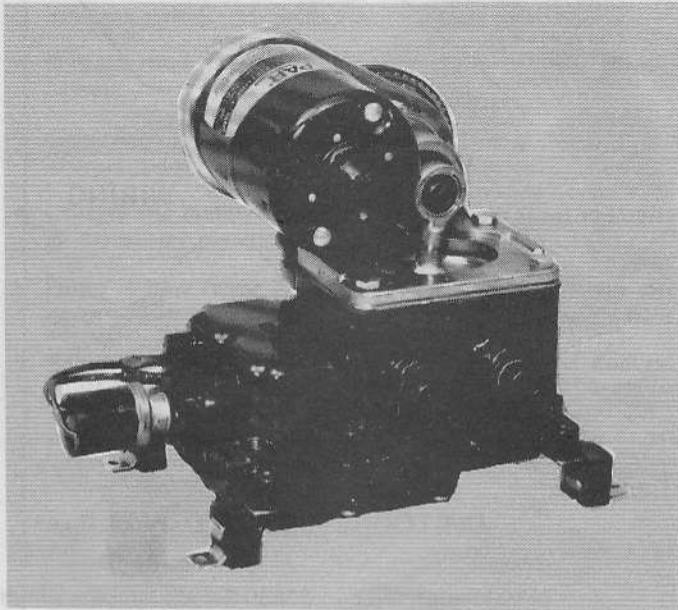

### APPLICATIONS

PAR automatic water system pumps are designed for self contained recreational vehicles and pleasure boats with multiple-fixture water systems. The systems are automatic — when a faucet is opened, the pump instantly begins operation to provide a constant flow from tank to faucet. Closing the faucet automatically discontinues pump operation. Models 36800 and 36850 are suited for up to five-fixture distribution systems. Models 36900 and 36905 are recommended for large distribution systems where duty requires simultaneous operation of multiple faucets. Model 36850-series and 36905-series with dry tank switch shut off automatically when water tank runs dry.

### DIMENSIONAL DRAWING

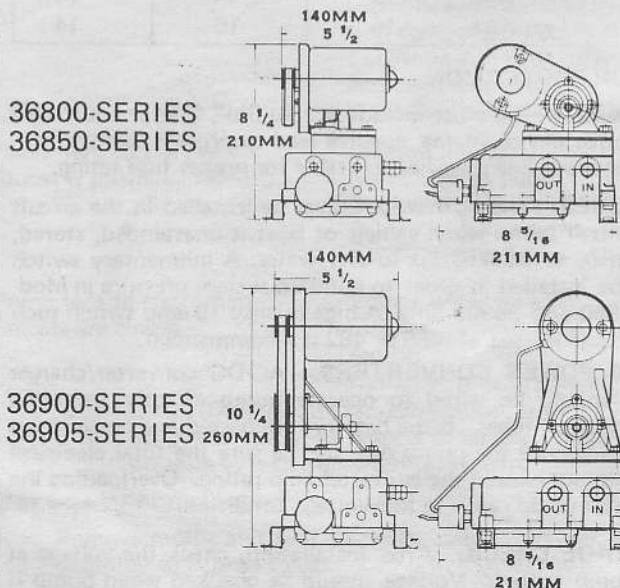

### FEATURES

- Self-Priming
- Diaphragm Design Allows Dry Running
- Built-in Discharge Check Valve
- Quiet Operation
- Built-in Hydraulic Pulsation Dampener
- Large Vibration Absorbing Pads
- Available with Barb or Threaded Ports
- Meets USCG Electrical Standards
- IAPMO Approved

### SPECIFICATIONS

	Open Flow	U.S. GPM	Liters/min.	Imp.GPM
36800/36850-Series:		3.3	12.5	2.75
36900/36905-Series:		4.2	15.9	3.5
Cut-in Pressure:	16 PSI Nom.		(1,1 kg/cm <sup>2</sup> )	
Cut-off Pressure:	33 PSI Nom.		(2,3 kg/cm <sup>2</sup> )	
Vert. Dry Suction Lift:	5 feet		(1,52 M)	
Ports:	Slip-on 1/2" or 5/8" I.D. Hose or 1/2" threads.			
Approx. Ship. Weight				
36800-Series:	11 Lbs.		5.0 kgs	
36850-Series:	11 1/2 Lbs.		5.2 kgs	
36900-Series:	13 Lbs.		5.9 kgs	
36905-Series:	13 1/2		6.2 kgs	
Approval:	IAPMO Type IV			

### STANDARD MODELS

36800-Series — Automatic Water System				
MODEL	VOLTAGE	NOM. AMP DRAW	FUSE RATING	
			SLO-BLO	NORMAL
36800-1000	12 VDC	6.0	6 1/4 AMP	8 AMP
36800-1010	24 VDC	3.0	3 AMP	4 AMP
36800-1020	32 VDC	2.2	2 AMP	3 AMP
36850-Series Automatic Water System with Dry Tank Cut-off Switch				
MODEL	VOLTAGE	NOM. AMP DRAW	FUSE RATING	
			SLO-BLO	NORMAL
36850-1000	12 VDC	6.0	6 1/4 AMP	8 AMP
36850-1010	24 VDC	3.0	3 AMP	4 AMP
36850-1020	32 VDC	2.2	2 AMP	3 AMP
36900-Series Automatic Water System				
MODEL	VOLTAGE	NOM. AMP DRAW	FUSE RATING	
			SLO-BLO	NORMAL
36900-1000	12 VDC	7.5	7 AMP	10 AMP
36900-1010	24 VDC	3.8	4 AMP	5 AMP
36900-1020	32 VDC	3.0	3 AMP	4 AMP
36905-Series Automatic Water System with Dry Tank Cut-off Switch				
MODEL	VOLTAGE	NOM. AMP DRAW	FUSE RATING	
			SLO-BLO	NORMAL
36905-1000	12 VDC	7.5	7 AMP	10 AMP
36905-1010	24 VDC	3.8	4 AMP	5 AMP
36905-1020	32 VDC	3.0	3 AMP	4 AMP

# INSTALLATION

## PLUMBING

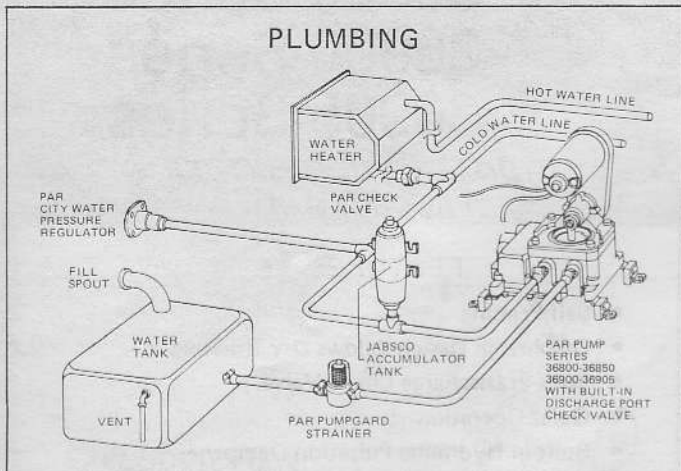

## MOUNTING

PAR diaphragm pumps are self-priming. They may be located above or below the fresh water tank. The pump is equipped with vibration pads which are most effective when the pump is mounted upright on a solid surface.

## PLUMBING

To minimize water pressure drop, the size of water supply line should not be less than sizes shown in the table below. Valves, elbows, etc. used should be the same size as pipe or tubing. Use gate valves only. Fresh water tank must be vented.

### MINIMUM PIPING SIZE

Supply Line Length	Hose I.D.	Pipe Size
Less than 48"	1/2"	3/8"
48" or more	5/8"	1/2"

**PRESSURE REGULATOR.** It is recommended that systems having a connection for a city water entry be equipped with a pressure regulating check valve set at approximately 35 PSI. This valve automatically regulates the incoming water pressure to avoid damage to pump and plumbing from excessive pressures. PAR Models 44410-0000 (Permanent Flush Mount) and 44410-0010 (In-line Hose Type) pressure regulating valves are recommended for this purpose.

**CHECK VALVES.** A built-in port check valve protects the pump from the unregulated high pressures sometimes encountered in city water hookups. However, an additional check valve may be installed at the cold water inlet of the water heater to minimize heat transfer to the cold water line and protect the system in case of water heater relief valve failure. PAR offers qualified in-line check valves, Model 34344-0000, 35027-0000, and 35195-0000.

**SUCTION FILTER.** A PAR Pumpguard Model 36400-0000 (strainer/filter) is recommended installed between the pump and fresh water tank. It helps prevent valve clogging caused by foreign material entering the pump.

**WATER PURIFIER.** Many water purifiers cause excessive restriction to flow, especially when element is in use for some time. When used at the main distribution line it causes the pump to cycle on and off rapidly. To minimize cycling, use an accumulator tank between pump and purifier, or install purifier to feed a single outlet for drinking-water only.

**ACCUMULATOR TANK.** The use of an accumulator tank (Jabsco Model 12573-0000), although not required, is recommended for a more effective water distribution system. It eliminates "water hammer", stores pressure to allow a limited use of water without restarting pump (desirable at night-time), assures a constant, even stream of water at faucets farthest

## WIRING

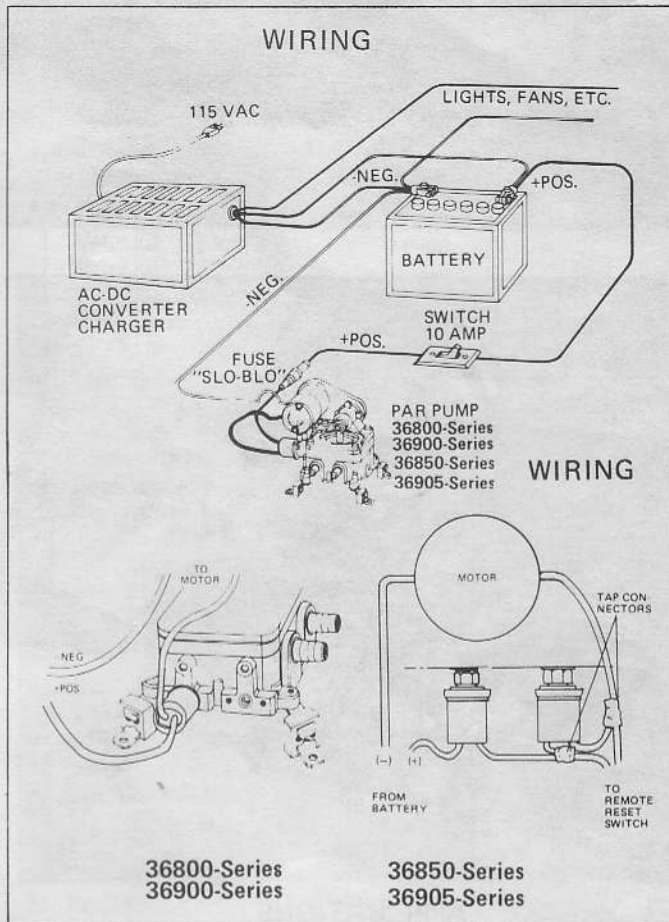

from pump and prolongs pump life by cutting down rapid start/stop operation.

## WIRING

Pump should be wired in an independent circuit according to the wiring diagram.

### WIRE SIZE CHART (A.W.G. - COPPER)

Length of circuit in feet (sum of +Pos. & -Neg. wire lengths)

Voltage	Up to 80'	80' to 100'	100' to 150'
12 Volts Two Wire	14	12	10
24 Volts Two Wire	16	14	14
32 Volts Two Wire	16	16	14

## MOTOR PROTECTION

The pump wiring must include a "Slo-Blo" fuse or equivalent protective device in the positive lead to protect against over-current draw. See specification table for proper fuse rating.

**SWITCHES.** An on-off switch must be installed in the circuit to turn off pump when vehicle or boat is unattended, stored, in transit, or hooked up to city water. A momentary switch must be installed in order to build up system pressure in Models 36850 and 36905 only. A high quality 10 amp switch such as the Cole Hersee #M485 or 492 is recommended.

**AC-DC POWER CONVERTERS.** AC-DC converter/charger packs should be wired to operate pump directly from the battery at all times. If the battery is bypassed and converter is used to service the pump directly, be sure the total electrical loads do not exceed the converter amp rating. Overloading the converter could result in low-voltage condition.

**VOLTAGE CHECK.** After installation, check the voltage at the pump motor. Voltage should be checked when pump is operating along with all the inside electrical fixtures. Full voltage must be available at the pump motor at all times.



## OPERATION

- Check water level in tank. Be sure valves are open and strainers and aerators are clean.
- Open all faucets, hot and cold.
- Turn on power to pump.
- On Models 36850 and 36905-Series pumps equipped with dry tank switch turn on momentary reset switch.
- Release reset switch when water starts to flow through faucets.
- Close each faucet when it starts to deliver a steady stream of water (close cold water first).
- Observe the pump. Check to be sure pump stops soon after all faucets are closed.
- Pump is now ready for automatic operation. It will start when a faucet is opened and stop when the faucet is closed.
- Relieve system pressure prior to city water or dockside hook-up.

## MAINTENANCE

**WINTER STORAGE.** The PAR pump with its unique pulsation dampener will withstand frozen water without damage, provided the system is not under pressure prior to freezing. To prevent accidental damage, the entire water system should be protected from freezing during winter storage. This requires complete draining, using the following directions and/or vehicle manufacturer's instructions:

1. Open all faucets and drains and allow pump to empty water tank and intake line. Run pump dry for 1 to 2 minutes before turning off.
2. With all drains open, blow air through city water entry. Allow time for water heater to empty.
3. Disconnect discharge and intake hoses from pump. Start pump and allow to run until all water is expelled from unit. (Running dry will not harm the pump.)
4. Reconnect the hoses, close the drains but leave faucets open. The water distribution system is now dry and ready for winter storage.

An alternate method is to use potable water system anti-freeze solution. Follow directions of anti-freeze manufacturer, and use a PAR Winter Protection Kit Model 44610-0000. **DO NOT USE AUTOMOTIVE TYPE RADIATOR ANTI-FREEZE. IT IS POISONOUS.**

## SERVICE

### TROUBLESHOOTING

Problem	Causes
Pump operates but no water flows through faucet.	<ul style="list-style-type: none"><li>— Low water level in tank.</li><li>— Water lines are clogged.</li><li>— Kink in water hose.</li><li>— Air leak in suction line.</li><li>— Dirty or hard-to-open in-line check valve.</li><li>— Defective pump valve.</li></ul>
Pump cycles on and off when faucets are closed.	<ul style="list-style-type: none"><li>— Water leak in plumbing.</li><li>— Defective toilet flush valve.</li><li>— Internal leak in output valve.</li></ul>
Pump operates roughly and has excessive noise and vibration.	<ul style="list-style-type: none"><li>— Intake line is restricted, kink in suction hose or fittings too small.</li><li>— Pump mounted on flimsy board.</li><li>— Deformed or ruptured pulsation dampener in pump.</li><li>— Loosened screws at pulleys and connecting rod.</li><li>— Worn connecting rod bearing.</li></ul>
Pump fails to start when faucet is opened.	<ul style="list-style-type: none"><li>— Clogged piping.</li><li>— No voltage to pump.</li><li>— Defective pressure switch.</li><li>— Empty water tank (Model 36850/36905 Series-only).</li></ul>
Pump fails to stop when faucets are closed.	<ul style="list-style-type: none"><li>— Empty water tank.</li><li>— Insufficient voltage to pump motor.</li><li>— Defective pressure switch.</li></ul>

**CAUTION: Before servicing pump, turn off power and open faucets to relieve pressure in water distribution system.**

### VALVES REPLACEMENT

1. Remove motor and four tie down-screws. Lift jack shaft assembly to expose valves.
2. Lift valves from pockets. Clean all foreign materials from valves and seats. Inspect rubber flappers for cuts.

3. Reinstall valves into same pockets, being sure rubber valve with small hole is UP on intake and rubber valve without the small hole is DOWN on discharge. **CAUTION:** Do not use valve with small hole in rubber on discharge side of pump.

4. Replace motor, do not overtighten belt.

### DIAPHRAGM AND CONNECTING ROD REPLACEMENT

1. Remove motor and four tie down screws, then lift jack shaft and attached diaphragm assembly from pump base.
2. Expose diaphragm by removing two diaphragm retainer screws and detaching retainer.
3. Remove diaphragm screw to separate diaphragm, plates and washer/spacer from connecting rod. Inspect diaphragm for cuts and ruptures.
4. Remove eccentric screw to separate connecting rod from jack shaft.
5. When reassembling, be sure to align diaphragm and connecting rod so that rod slips straight onto jack shaft and diaphragm rests squarely on diaphragm retainer.
6. Replace motor, do not overtighten belt.

### PULSATION DAMPENERS REPLACEMENT

1. Remove nine screws from bottom plate and three screws from small bottom plate. Mark bottom of small plate for proper reassembly.
2. Pull out rubber pulsation dampeners from base. Inspect for excessive deformation, ruptures and cuts.
3. When installing new large pulsation dampener, check that its metal screw sleeve-guide is positioned between center hole and screw-way in the base. Make sure that flanges of both pulsation dampeners are well-seated to effect a proper water and air seal.

### PRESSURE SWITCH REPLACEMENT

1. Turn off power to pump and open faucet to relieve pressure from system.
2. Disconnect all wires from pressure switch.
3. Unscrew switch from base.
4. Thread new switch with sealing washer into pump base, with metallic side of washer facing switch. Tighten securely.
5. Rewire one lead to motor, other to fused circuit.

### DRY TANK SWITCH REPLACEMENT

1. Disconnect all wires from dry tank switch (Model 36850/36905 Series only.)
2. Unscrew switch from base.

SERVICE (Continued)

DRY TANK SWITCH REPLACEMENT (Continued)

3. Thread new switch with sealing washer into base, with metallic side of washer facing switch. Tighten securely.
4. Rewire per wiring diagram.

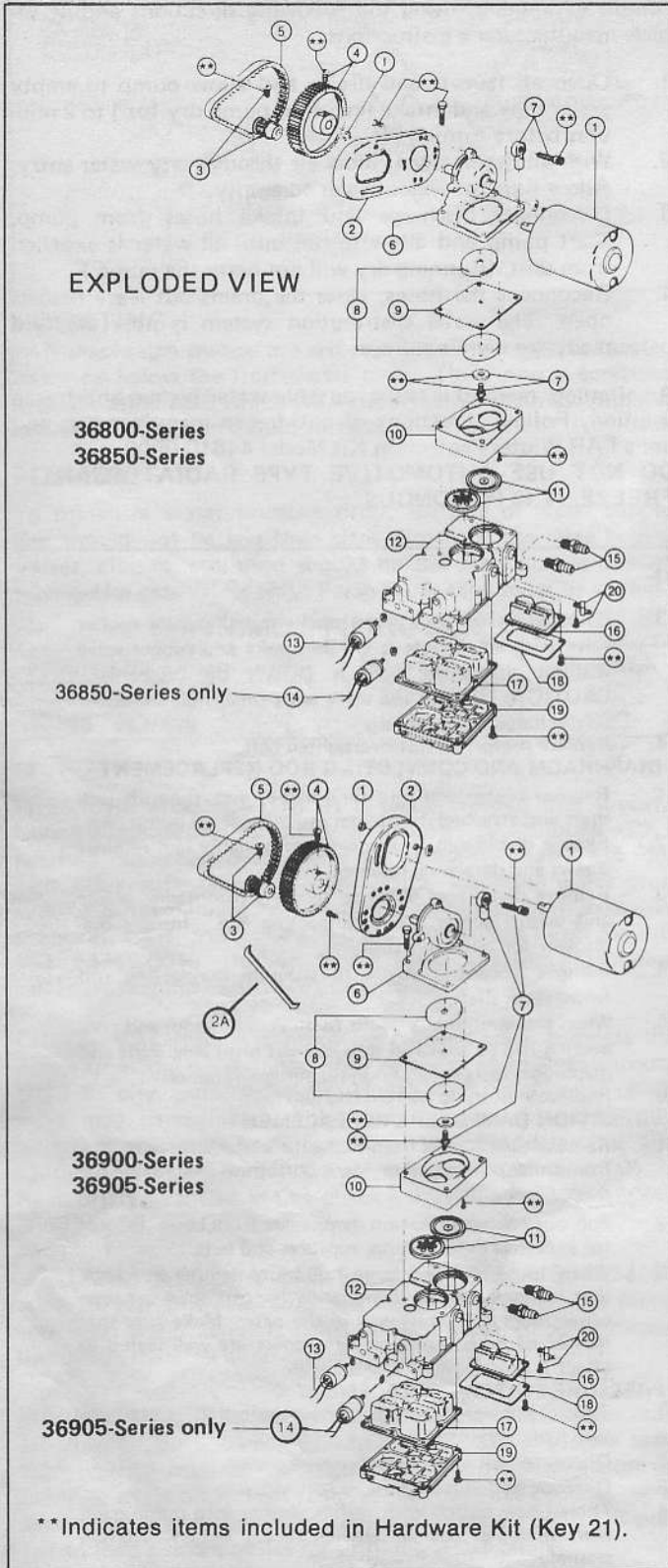

MOTOR REPLACEMENT

1. Remove two motor nuts to separate motor.
2. Loosen set screw to remove small pulley from motor shaft.
3. When reassembling, adjust belt tension so belt between pulleys can be depressed 1/4" after motor nuts are tightened. Do not overtighten belt.

PARTS LIST  
36800/36850 Series

Key	Part Description	Part Number	Qty
1	Motor Kit 12 Volt D.C.	30200-0000	1
1	Motor Kit 24 Volt D.C.	30200-0010	
1	Motor Kit 32 Volt D.C.	30200-0020	
2	Motor Mount	34628-0000	1
3	Small Pulley	37169-0000	1
4	Large Pulley	37170-0000	
5	Belt	30021-0000*	1
6	Jack Shaft Assembly	35506-0000	1
7	Connecting Rod Assembly	37173-0000	1
8	Diaphragm Plate	35503-0000	2
9	Diaphragm	30015-0000*	1
10	Retainer	35497-0000	1
11	Valve Set (Inlet & Outlet)	30004-0000*†	1 Set
12	Base Assembly†	35625-1100†	1
		35625-1200†—for 36850-Series	
13	Pressure Switch	37121-0000—See Note 2	1
		44814-0000—See Note 3	
14	Dry Tank Switch	35675-0010—See Note 5	1
15	Ports (Inlet & Outlet) Barb	37176-0000†—See Note 4	1 Set
16	Small Pulsation Dampener	37177-0000*†	1
17	Pulsation Dampener	37178-0000*†	1
18	Small Bottom Plate	35628-0000†	1
19	Bottom Plate	35623-0000†	1
20	Vibration Pad Kit	37180-0000†	1 Set
21	Hardware Kit	37165-0000	1 Set
	Service Kit*	30122-0000	

36900/36905-Series

Key	Part Description	Part Number	Qty
1	Motor Kit 12 Volt D.C.	30200-0000	1
1	Motor Kit 24 Volt D.C.	30200-0010	
1	Motor Kit 32 Volt D.C.	30200-0020	
2	Motor Mount	34628-0000	1
2A	Brace	35256-0010	2
3	Small Pulley	37169-0000	1
4	Large Pulley	37170-0000	
5	Belt	30021-0000*	1
6	Jack Shaft Assembly	35690-0000	1
7	Connecting Rod Assembly	37173-0000	1
8	Diaphragm Plates	35212-0000	2
9	Diaphragm	30016-0000*	1
10	Retainer	35173-0000	1
11	Valve Set (Inlet & Outlet)	30004-0000*†	1 Set
12	Base Assembly†	35625-1100†	1
		35625-1200†—for 36905-Series	
13	Pressure Switch	37121-0000—See Note 2	1
		44814-0000—See Note 3	
14	Dry Tank Switch	35675-0010—See Note 5	1
15	Ports (Inlet & Outlet) Barb	37176-0000—See Note 4	1 Set
16	Small Pulsation Dampener	37177-0000*†	1
17	Pulsation Dampener	37178-0000*†	1
18	Small Bottom Plate	35628-0000†	1
19	Bottom Plate	35623-0000†	1
20	Vibration Pad Kit	37180-0000†	1 Set
21	Hardware Kit	37165-0000	1 Set
	Service Kit*	37121-0000	

\*Indicates Parts Contained in Service Kit.  
 †Indicates Parts Supplied with Base Assembly.  
 NOTE 2—Includes Switch and Conversion Kit to Mount New Style Switch Onto Older Style J and -0000 Pumps.  
 NOTE 3—Direct Replacement Switch Only for -1000 Series Pumps. Meets USCG Electrical Standards.  
 NOTE 4—Threaded Outlet Port 43006-2000 Threaded Inlet Port 42986-2000  
 NOTE 5—To convert earlier models from old "Red Box" switch order 35675-0000.

JABSCO PRODUCTS **ITT**

Marine and Recreation Components Division  
 International Telephone and Telegraph Corporation  
 1485 Dale Way, Costa Mesa, California 92626  
 Telephone: (714) 545-8251

© Copyright 1978, International Telephone and Telegraph Corporation

Printed in U.S.A. All rights reserved. Form 43000-0102 Rev. 1/78