

PARTS LIST			MEDIUM PRESSURE IMPELLER		HIGH PRESSURE IMPELLER	
Key	Description	Qty	Neoprene Elast: 28530-2111	Neoprene Elast: 28530-2125	Nitrile Elast: 28530-2123	
1	Screw	4	X3001-207F	X3001-207F	X3001-207F	
2	Endcover	1	28505-0010	28505-0010	28505-0010	
3	"O" Ring	1	X4020-424A	X4020-424A	X4020-424A	
4	Impeller	1	8963-0011B	8600-0005B	8600-0023B	
5	Body	1	28504-2002	28504-2002	28504-2002	
6	"O" Ring	1	X4020-424A	X4020-424A	X4020-424A	
7	Wearplate (2)	1	28536-0000	28536-0000	28536-0000	
8	Seal Assy (2)	1	28531-0103B	28531-0103B	28531-0103B	
9	Seal Spacer (1)	1	28517-0000	28517-0000	28517-0000	
10	Lip Seal	1	SP2701-0912	SP2701-0912	SP2701-0912	
11	Retaining Ring	1	SP1701-437	SP1701-437	SP1701-437	
12	Washer	4	X3080-101F	X3080-101F	X3080-101F	
13	Screw	4	X3001-209F	X3001-209F	X3001-209F	
14	Bearing Housing	1	28503-0000	28503-0000	28503-0000	
15	Retaining Ring	1	SP1701-437	SP1701-437	SP1701-437	
16	Lip Seal	1	SP2701-0912	SP2701-0912	SP2701-0912	
17	Key	1	X4000-487A	X4000-487A	X4000-487A	
18	Bearing	1	SP2601-23	SP2601-23	SP2601-23	
19	Shaft	1	28507-0000	28507-0000	28507-0000	
20	Bearing	1	SP2601-23	SP2601-23	SP2601-23	
Service Kit Contains*			SK379-0111	SK379-0125	SK379-0123	

Other Seal Options						
Model No. With H/F Seal	28530-2211	28530-2225	28530-2223			
Model No. With Lip Seal	28530-2411	28530-2425	28530-2423			
Model No. With H/F Seal Flushed	28530-2711	28530-2725	28530-2723			
Model No. With Standard Seal Flushed	28530-2911	28530-2925	28530-2923			

Parts For Appropriate Seal Conversion						
8	H/F Seal Assy	1	28531-0203B	28531-0203B	28531-0203B	
Lip Seal Kit No. & Contains			28531-0403B	28531-0403B	28531-0403B	
21	Seal Spacer	1	28565-0011	28565-0011	28565-0011	
22	"O" Ring	1	X4020-229A	X4020-229A	X4020-229A	
23	Lip Seal	1	SP2701-0915	SP2701-0915	SP2701-0915	
24	Wearplate	1	28566-0000	28566-0000	28566-0000	
Flush Seal Kit No. & Contains			28532-0000B	28532-0000B	28532-0000B	
25	"O" Ring	1	X4020-269A	X4020-269A	X4020-269A	
26	Seal Housing	1	28512-0000	28512-0000	28512-0000	
27	Tube	2	21844	21844	21844	
28	Seal Spacer	1	28517-0001	28517-0001	28517-0001	
29	"O" Ring	1	X4020-229A	X4020-229A	X4020-229A	
30	Seal	1	SP2701-0915	SP2701-0915	SP2701-0915	

(1) Key 9 Not Required For Models With Lip Seal And Flush Seal. (2) Key 7 & 8 Not Required For Lip Seal Models

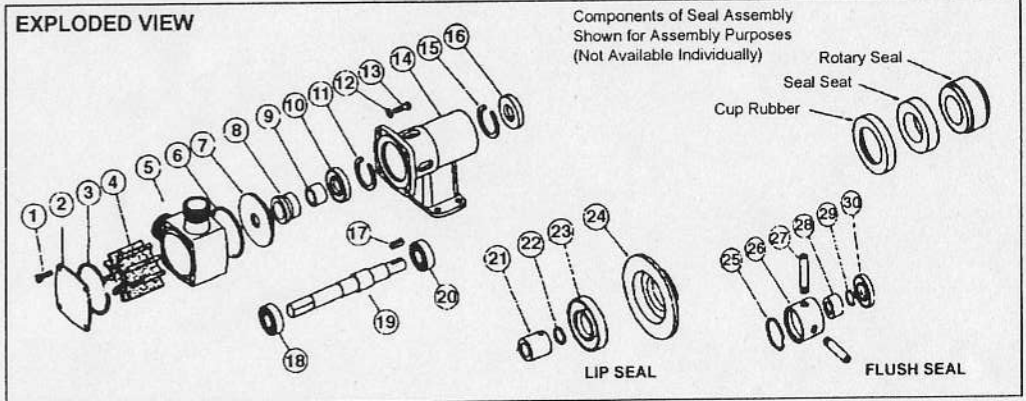

SERVICE INSTRUCTIONS

Dis-Assembly

1. Remove screws (1), endcover and "O" ring. Remove screws (13). Slide off body complete with impeller and wearplate.
2. Remove seal seat, cup rubber from the wearplate and push out impeller and "O" ring from body.
3. Gently lever the seal spacer and seal (8) off the shaft.
4. Prise out seal (16). Remove retaining ring (15) and carefully withdraw shaft and bearing assembly. Remove retaining ring (11) and push out seal (10).
5. To remove bearings from shaft an arbor press is required alternatively a bearing extractor may be used. Support inner race of bearing then apply a steady pressure on shaft until bearing is free. Repeat this procedure to remove other bearing.

PUMPS WITH LIP SEAL:- Push out lip seal (23) from wearplate (24). Loosen set screw to remove seal spacer (21). Prise out "O" ring (22) from seal spacer.

PUMPS WITH FLUSH SEAL:- After pulling out rotary seal, unscrew tubes (27) and pull out seal housing (26). Remove seal spacer (28) and prise out "O" ring (29). Remove "O" ring (25) and lip seal (30) from seal housing.

Assembly

1. To fit bearings onto shaft - Support inner race of bearing and press the shaft until bearing locates against the shoulder. Repeat procedure for other bearing.
2. Fit retaining ring (11) and lip seal (10) ensuring that spring on seal is facing outwards.
3. Fill the bearing with grease, and the space between bearings two thirds full. Smear grease on the shaft where lip seal locates. Push shaft and bearing assembly into bearing housing. Fit retaining ring (15) and seal (16) with spring facing outwards.
4. To fit seal - Smear shaft with lubricating oil and slide seal spacer (9) up to the shoulder on shaft. Push rotary seal gently until it touches the spacer. Fit cup rubber and seal seat into wearplate (7). Slide wearplate assembly over the shaft.
5. Fit impeller into lubricated body with twisting motion in the same rotation as motor. Fit "O" ring (6) into body and slide over shaft.
6. Align wearplate and body into bearing housing and secure with screws (13) and washers (12). Do Not overtighten, a gap between bearing housing and body is normal. These screws and endcover screws should be tightened to a torque of 13.5 Nm.
7. Fit "O" ring (3) into body and place endcover over body and secure with screws (1). **PUMPS WITH LIP SEAL:-** Ensure "O" ring (22) is fitted under seal spacer (21). Smear seal spacer and shaft with lubricating oil. Slide spacer over shaft and secure with set screw to dimension shown. Press lip seal (23) into wearplate (24) and follow on from step 5 above.

PUMPS WITH FLUSH SEAL:- Ensure "O" ring (30) is fitted under seal spacer (28). Smear seal spacer and shaft with lubricating oil. Slide spacer over shaft up to shoulder. Press lip seal (30) into seal housing (26) and slide into position over shaft. Fit tubes (27) sealing with PTFE tape. Rotary seal and "O" ring (25) can now be fitted. Follow on from step (5) above.

Inspect all parts for wear or damage and replace if necessary.

