

# JABSCO® PUMPS

## Submersible Bilge Pump

**Models: 18490-0000 (12V)**  
**18490-0001 (24V)**  
**18490-0002 (32V)**  
**Product Data**

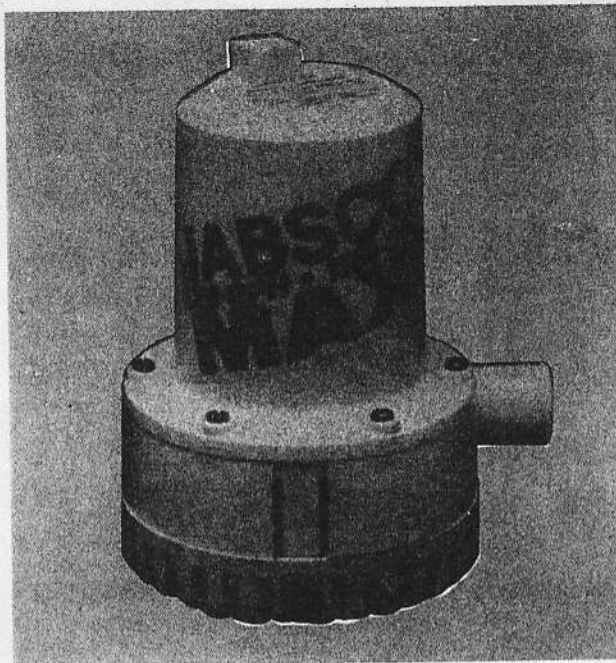

### DESIGN FEATURES

- Fully Submersible.
- Easy to Install.
- Corrosion Resistant, Acetal Construction.
- Easy to Clean, Large Area Strainer.
- Can Run Dry Without Damage.
- Meets Applicable Sections of U.S. Coast Guard (Title 33, Chapter I, Section 183, 410) and are BIA Type Accepted.

### SPECIFICATIONS:

**Capacity:** 1750 US Gal/Hr, 6600 l/Hr,  
1470 IMP Gal/Hr  
**Discharge Port:** 1-1/8 inch (2.86 cm) DIA Hose  
**Weight:** 2 lbs. 15 ozs (1.33 kg)  
**Height:** 6-7/8 inch (17.5 cm)  
**Base:** 4-7/8 inch (12.4 cm) Diameter  
**Shaft:** Stainless Steel  
**Seal:** Teflon Double Lip Seal  
**Wire:** 30 inch (76.2 cm) Long

18490-0001 (24V)  
18490-0002 (32V)

### INSTALLATION

Locate the lowest point in the bilge. Remove the lower strainer base from the main housing by depressing the two tabs firmly and pulling to separate. Do not attempt to disassemble the six screws from the pump housing. Place the strainer base in the desired location and rotate until the pump discharge port will be level or pointed slightly upward when the pump base is mounted and reassembled to the main housing. (See Figure No. 1.)

Mark the hull in the four mounting hole locations on the strainer base and drill for No. 10 (4.8 mm) self tapping screws. Use only stainless steel fasteners. Mount strainer base with 4 screws. (Do not crack the base by overtightening if the hull surface is uneven.) Reassemble pump housing to strainer base.

Connect 1-1/8 inch diameter hose to discharge nozzle and secure with corrosion resistant clamp. Make sure that the hose is free of kinks, or sharp bends. Be sure that the hose is above the discharge port at all points to avoid airlock. (See Figure No. 2).

Figure No. 1

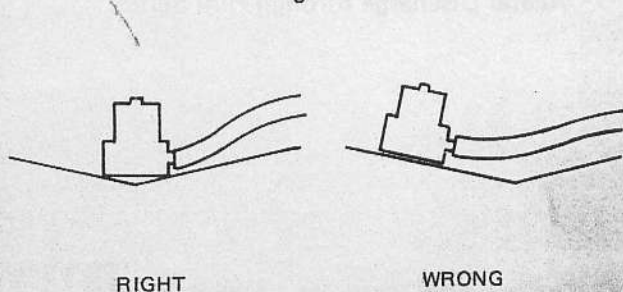
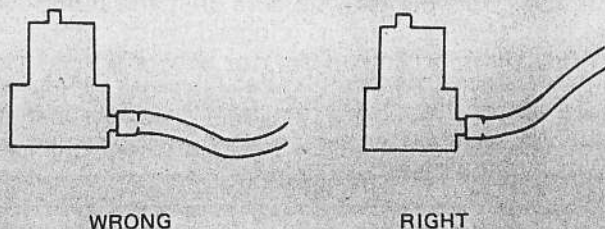

Figure No. 2



# JABSCO PRODUCTS ITT

Form 43000-0353 10-79

## WIRING

Pump Model	Voltage/Amp.	Fuse	Wiresize*
18490-0000	12v DC/8.5	10 Amp.	14 gauge
18490-0001	24v DC/4.3	7.5 Amp.	18 gauge
18490-0002	32v DC/3.1	5.0 Amp.	18 gauge

\*If wire length from the power source to the pump exceeds 20 feet (6.1 meters), in 12v DC systems, use 12 gauge wire. If wire length from the power source to the pump exceeds 35 feet (10.7 meters) in 24v DC systems use 16 gauge wire.

Connect red or orange wire to the switch and fuse on the positive battery lead and the black wire to the negative battery lead. Install a proper sized fuse in the positive battery lead as shown in Figure No. 3. Check for proper pump rotation, if improper reverse the motor leads. Be sure that all electrical connections are above the highest bilge water level.

Figure 3

### WIRING DIAGRAM

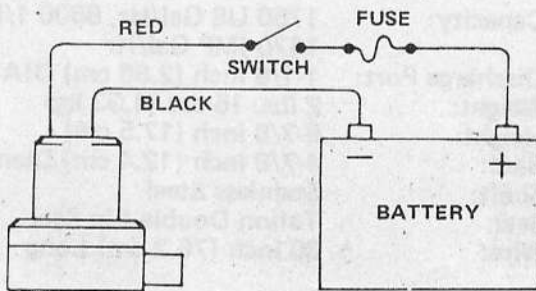

MANUAL OPERATION

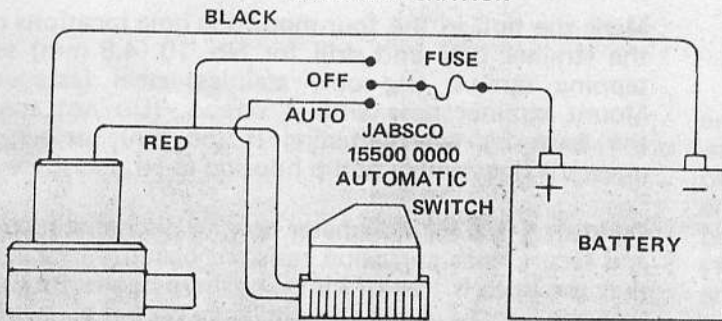

MANUAL/AUTOMATIC OPERATION

### OPERATION AND MAINTENANCE:

For long, reliable life, be sure that the pump is not used in a bilge that is clogged with debris. This JABSCO pump can run dry for short periods of time without damage, however, excessive dry running will reduce pump life. Check the pump strainer and the automatic bilge switch for build up of debris that can clog or jam the switch or pump.

## BILGE PUMP ACCESSORIES

Jabsco Automatic Switch  
Model 15500-0000 —  
Turns pump on and off automatically  
to keep bilges dry at all times.

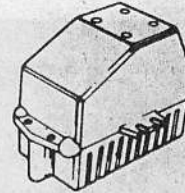

PAR Bilge Pump Hose,  
Model 93003-0250, 1-1/8" (2.86 cm) ID  
Plastic discharge hose with cuffs every  
foot for easy cutting.

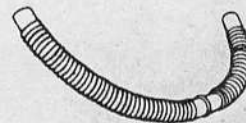

Jabsco Two and Three-Position Switches  
Series-44960 Attractive Switches in  
lighted or unlighted versions.

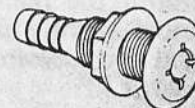

Acetal Discharge through Hull Series.

# JABSCO PRODUCTS **ITT**

Marine and Recreation Components Division  
International Telephone and Telegraph Corporation  
1485 Dale Way, Costa Mesa, California 92626 Phone 714/545-8251