

MODELS	SIZE	SHAFT END						MOUNTING FLANGE				PORT FLANGE				
		A	B	C	D	E	G	H	J	K	L	M	N	R	S	
10880-07,57	200	22,212/22,225	-	25	41	¾-16 UNF/2A	4.8	127	108	10.3	84	48	82.6	¾-16 UNC/2B	123	151
11100-01-01 -31 -0541	270	23,470/23,500	5:1	26	41	¾-16 UNF/2A	No Key	127	108	10.3	86	57	90.5	¾-24 UNF/2B	123	176
		22,212/22,225	-	25	41	¾-16 UNF/2A	4.8	127	108	10.3	86	57	90.5	¾-24 UNF/2B	123	176
		28,600/28,650	6:1	28	46	M18X1.5-6g	6	120	103	9	86	57	90.5	M10x6H	123	176

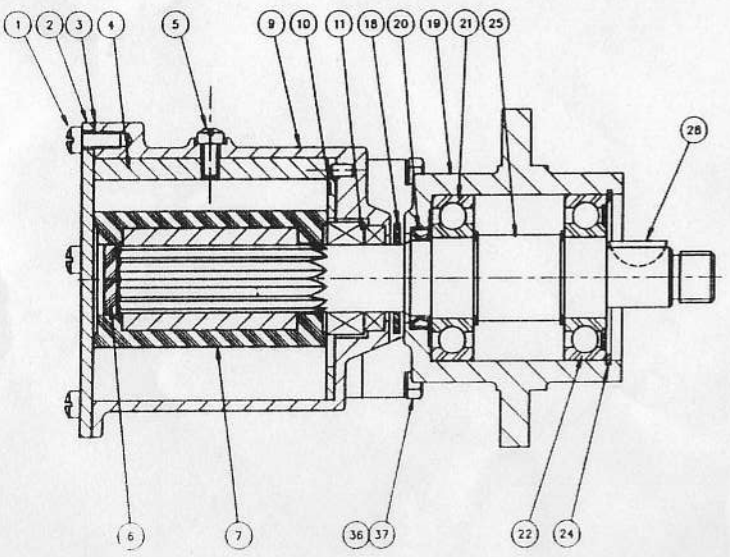

KEY	DESCRIPTION	QTY	PART NUMBER				
			MODEL 10880-07	MODEL 10880-57	MODEL 11100-01-01	MODEL 11100-31	MODEL 11100-0541
1	END COVER SCREW	5	SP1005-04	SP1005-04	SP1005-04	SP1005-04	SP1005-04
2	END COVER	1	9336	9336	9336	9336	9336
3	GASKET	1	816	816	816	816	816
4	CAM	1	834	2551	6988	6988	22268
5	CAM SCREW	1	SP1005-04	SP1005-05	SP1005-04	SP1005-04	SP1006-05
6	SPLINE PLUG	1	4346	4346	4346	4346	4346
7	IMPELLER	1	17935-0001	17235-0001	21676-0001	21676-0001	21676-0001
9	BODY	1	10584	10584	11104-01	11104-01	11104-03
-	PLUG (NOT SHOWN)	2	-	-	-	-	SP2650-0226
10	WEARPLATE	1	2574	2574	2574	2574	2574
11	MECH. SEAL ASSY	1	21849	21849	21849	21849	21849
18	SLINGER	1	3181	3181	3181	3181	3181
19	BEARING HOUSING	1	10594-0030	10594-0030	10594-0030	10594-0030	10594-0040
20	LIP SEAL	1	SP2701-54	SP2701-54	SP2701-54	SP2701-54	SP2701-54
21	BEARING	1	SP2601-37	SP2601-37	SP2601-37	SP2601-0458	SP2601-0458
22	BEARING (OUTER)	1	SP2601-41	SP2601-41	SP2601-41	SP2601-0458	SP2601-0458
24	RETAINING RING (INT)	1	SP1701-244	SP1701-244	SP1701-244	SP1701-244	SP1701-244
25	SHAFT ASSY	1	11258	11258	11493-01	11258-01	23387-9010
-	RETAINING RING	2	Y5026-08	Y5026-08	Y5026-08	Y5026-08	Y5026-08
28	KEY	1	SP1402-04	SP1402-04	-	SP1402-04	SP1402-0303
36	BOLT	4	SP1094-0100	SP1094-0100	SP1094-0100	SP1094-0100	SP1094-0100
37	WASHER	4	SP1602-13	SP1602-13	SP1602-13	SP1602-13	SP1602-13

Service Kit SK230 SK254
contains: Impeller, spline plug, seal assembly, gasket, end cover screws.
Mech. seal assembly consists of: carbon seal (rotary), ceramic seat (stationary), gasket