

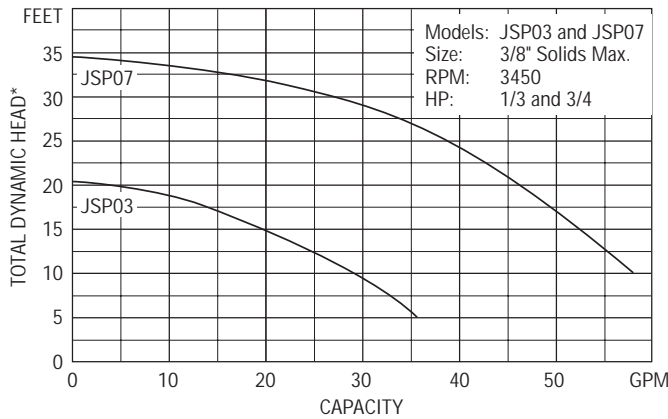

Models JSP03 and JSP07

SUBMERSIBLE SUMP PUMPS



*Vertical distance from water level to highest point in discharge – plus pipe friction.
 Maximum pump rated submergence is 10 ft. for JSP03; 16 ft. for JSP07.



Models JSP03 and JSP07

TO AVOID SERIOUS OR FATAL PERSONAL INJURY OR MAJOR PROPERTY DAMAGE, READ AND FOLLOW ALL SAFETY INSTRUCTIONS IN MANUAL AND ON PUMP.



This is a SAFETY ALERT SYMBOL. When you see this symbol on the pump or in the manual, look for one of the following signal words and be alert to the potential for personal injury or property damage.

⚠ DANGER

Warns of hazards that WILL cause serious personal injury, death or major property damage.

⚠ WARNING

Warns of hazards that CAN cause serious personal injury, death or major property damage.

⚠ CAUTION

Warns of hazards that CAN cause personal injury or property damage.

Notice: Indicates special instructions which are very important and must be followed.

THIS MANUAL MUST BE KEPT WITH THE PUMP.

MAINTAIN SAFETY LABELS

IMPORTANT PRE-INSTALLATION INFORMATION



All electrical work must be performed by a qualified technician. Always follow the National Electrical Code (NEC), or the Canadian Electrical Code, as well as all local, state and provincial codes.



The pump must be connected to a dedicated electrical circuit protected by a properly sized circuit breaker or fuses. Install a ground fault disconnect where required by code. Code questions should be directed to your electrical inspector. See Chart 1 for specific information.



Disconnect electrical power before installing or servicing the pump. The motor's automatic thermal overload protection may allow an overheated pump to restart unexpectedly.



Pump is not designed for use in swimming pools, open bodies of water, hazardous liquids, or where flammable gases exist.



Pumps and floats equipped with a 3-prong grounded plug must be connected to a 3-wire receptacle. Do not attach to extensions or connectors without a 3-prong grounded plug. Removing the plug from the power cord is allowable as long as the hard wiring is done per code by a qualified technician. Removing the plug will not void the warranty or agency listing.

1. GENERAL INFORMATION

- 1.1. Sump pumps are designed to operate intermittently and usually seasonally. It is recommended that you test the pump before your rainy season begins to insure that the pump and switch are operating properly.
- 1.2. We suggest installing a high water alarm system and a battery back-up pump system for finished basements or areas where flooding will cause property damage. A back-up generator is another option you can discuss with your pump installer. Most power outages occur during rain storms, just when you need your sump pump the most! Pump manufacturer's warranties cover only the pump. Labor and incidental damage such as flooding is not covered.

2. PRE-INSTALLATION CHECKS

- 2.1. Open all cartons and inspect for shipping damage. Report any damage to your supplier immediately.
- 2.2. Verify that all equipment is the correct voltage. Warranty does not cover damage caused by connecting pumps and controls to incorrect voltage.
- 2.3. Is your basin sized correctly and the proper type for the location?

Diameter – It must be wide enough to allow the pump and switch to physically fit and provide room for the switch to operate freely. See “min. basin diameter” in Chart 1.

CAUTION **Depth** – It must be deeper than the minimum depth at which the switch turns the pump On. As an example, if the pump turns on at 15" you want to use a basin deeper than 15".

See "On level" in Chart 1.

WARNING **Style** – There are several sump basin styles available. The location of the sump determines if you require a cover and what type you require. It is important to keep debris from entering the sump and clogging the pump. An open sump in a traffic area such as a basement is dangerous. If children or pets will be playing in the area a bolt-on or child-proof cover is recommended.

3. PIPING

- 3.1. Discharge pipe should be the same size as the

pump discharge to insure optimum performance. Using undersized pipe may dramatically reduce the flow and therefore waste energy. Your pump supplier can suggest the correct pipe for your installation.

- 3.2. Install a threaded pipe adapter, matched to the pipe type you are using, into the threaded pump discharge. One end will have a male thread and the other end will have a barbed connector, compression fitting or solvent weld connector. Use Teflon® tape on all threaded joints. If using solvent welded pipe and fittings it is best to dry fit them first and after verifying the fit, solvent weld. A union installed just above the sump or basin cover will facilitate future maintenance and replacement. See Chart 1 for discharge sizes.
- 3.3. Install a line check valve within 2 feet of the pump. Install per valve manufacturer's instructions.

IMPORTANT – Drill a 1/8" (3.2mm) relief hole in the discharge line approximately 2" (51mm) above the pump discharge connection but below the check valve and within the sump. This “relief” hole allows trapped air to escape from the pump and prevents air-locking the pump. Failure to drill this hole is a major cause of sump pumps failing to pump after long periods of inactivity such as seasonal use.

4. INSTALLATION IN SUMP

- 4.1. The pump can be placed directly on the bottom of a poly or fiberglass sump basin or a concrete sump bottom. If the bottom is packed gravel the stones must be larger than 1/2" (13mm) in diameter and the pump should be placed on bricks for support.
- 4.2. After connecting the discharge pipe to the pump it can be lowered into the sump (basin). Always lower the pump by the handle and the pipe, never by the power cord. Place the pump against the basin wall so the switch is to the center. See Figure 1.

MODEL INFORMATION

(Chart 1)

Model No.	HP	Volts	Amps	Min. Circuit Breaker	Phase	Float Switch Style	Cord Length	Discharge Connection	Min. On Level	Min. Off Level	Min. Basin Dia.	Max. Solids Size	Shipping Weight lbs/kg
JSP03	1/3	115	2.8	10	1	Piggyback Wide Angle	20'	1-1/2"	11"	5"	12"	3/8"	11/5
JSP07	3/4	115	6.6	10	1	Piggyback Wide Angle	20'	1-1/2"	12.5"	6.5"	12"	3/8"	15/6.8

- 4.3. Check to insure all piping connections are tight. The pipes should be supported by fastening to floor joists or wall. This will prevent the pump from moving in the sump. If it moves the switch could get stuck and either keep the pump running or not let it turn on.
- 4.4. The power to the outlet should be Off at this point. The dedicated outlet should supply power only to the pump.
- 4.5. Piggyback/Two Power Cords – insert the piggyback switch male plug into a dedicated power outlet. You then plug the standard male pump plug into the back, female side, of the piggyback switch plug. See Figure 2.
- 4.6. Fasten the power cords to the discharge pipes using tie wraps or electrical tape. Coil and store any excess power cord outside the sump.

5. OPERATION

- 5.1. Turn the power On at the breaker panel and/or the disconnect switch.
- 5.2. Fill the basin with water and observe where the pump turns On and Off. It should go On well before the water overflows the top of the sump. The pump should go Off before the water goes below the pump suction. The On-Off cycle with wide-angle float switches is adjustable. Adjustment is made by changing the tether length between the switch body and the switch tether (pivot) point. The tether length cannot be less than 3" – 3.5". Tethers less than 3" may not allow the float to drop down enough to turn off. See Figures 1, 3, 4 and 5.
- 5.3. **⚠ WARNING** Install a cover on the sump basin if there is a danger of debris, children, or pets falling into the basin. See Basin "Style" in Section 2.3.

6. SEASONAL SERVICE / MAINTENANCE

- 6.1. If your sump pump only operates seasonally and then sits idle for months it is recommended that you test the pump before your rainy season begins. Fill the sump with water and check for debris and proper switch operation. Remove any debris which could clog the suction strainer or jam the switch. Insure that the switch operates freely and does not hit the sump wall or hang-up on piping or power cords.

7. TROUBLE SHOOTING

Extreme caution should be exercised when servicing electrical devices. Fatal injuries could result from electrical shock. Always disconnect the electrical power from the device being serviced unless it is necessary for the work being done.

MOTOR NOT RUNNING

(See causes 1, 2, 3, 4, 6, 8)

LITTLE OR NO LIQUID DELIVERED

(See causes 5, 6, 7, 8, 10)

PUMP WILL NOT TURN OFF

(See causes 7, 8, 9, 10, 13)

PUMP CYCLES CONSTANTLY

(See causes 9, 11, 12, 13)

PROBABLE CAUSES:

1. Tripped thermal protector.
2. Open Circuit breaker or blown fuse.
3. Rotating parts binding.
4. Defective motor.
5. Air locked.
6. Low voltage.
7. System head too high.
8. Pump clogged.
9. Level control defective or switch not properly positioned.
10. Improper check valve direction.
11. Check valve leaking.
12. Incorrect size basin or wet-well.
13. Inflow excessive for size of pump.

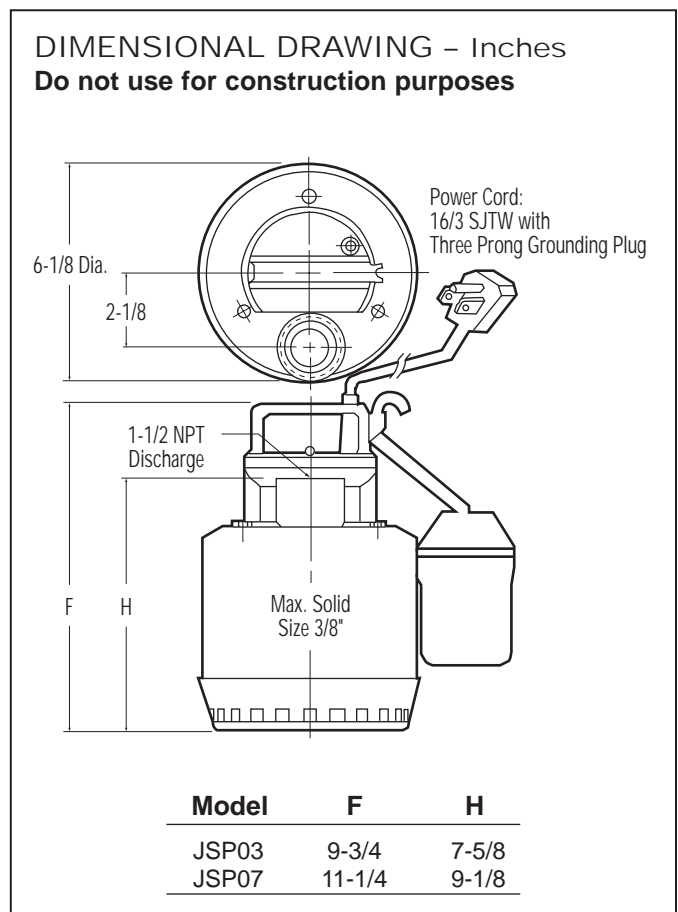

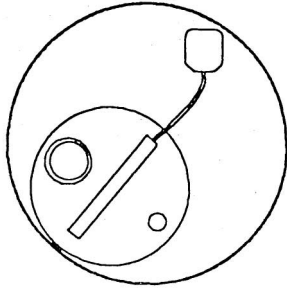

Suggested Pump Positioning in Sump
Figure 1

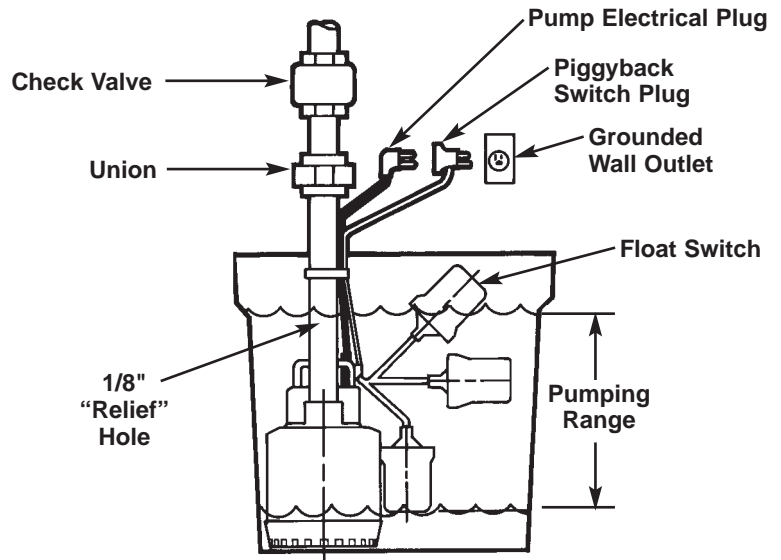

Typical Pump Installation in Sump
Figure 4

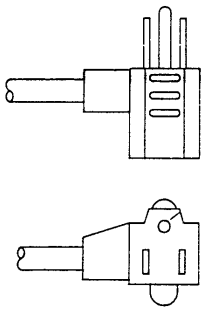

Piggyback Plug
Figure 2

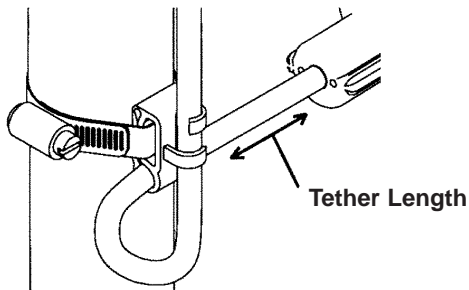

Wide Angle Float Mounting Strap
Figure 3

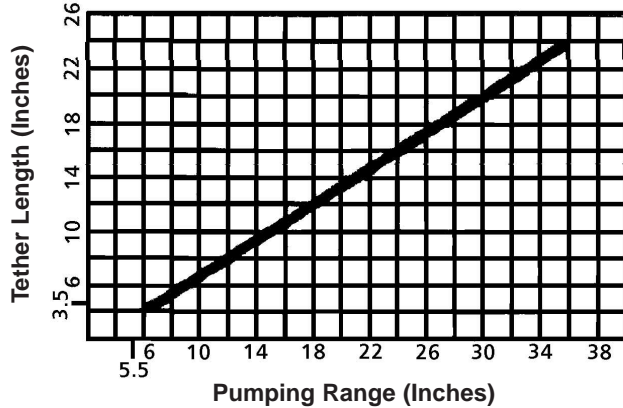

Tether Length vs. Pumping Range Curve
Figure 5

Jabsco



THE PRODUCTS DESCRIBED HEREIN ARE SUBJECT TO THE JABSCO ONE YEAR LIMITED WARRANTY, WHICH IS AVAILABLE FOR YOUR INSPECTION UPON REQUEST.

U.S.A.
Jabsco - Flojet
20 Icon
Foothill Ranch, CA 92610-3000
Tel: 949.609.5106
Fax: 949.859.1254

UNITED KINGDOM
Jabsco
Bingley Road, Hoddesdon
Hertfordshire EN11 0BU
Tel: +44 (0) 1992 450145
Fax: +44 (0) 1992 467132

CANADA
Fluid Products Canada
55 Royal Road
Guelph, Ontario N1H 1T1
Tel: (519) 821.1900
Fax: (519) 821.2569

JAPAN
NHK Jabsco Company Ltd.
3-21-10, Shin-Yokohama
Kohoku-Ku, Yokohama, 222
Tel: 045.475.8906
Fax: 045.475.8908

GERMANY
Jabsco GmbH
Oststrasse 28
22840 Norderstedt
Tel: +49-40-53 53 73 -0
Fax: +49-40-53 53 73 -11