

“CYCLONE PUMP”

Stainless Steel DC Motor / Pump Unit

A range of Stainless Steel General Purpose Centrifugal pumps designed specifically for the marine and industrial markets. Typical applications would be for circulation applications such as hot water systems, livewell or bait tank installations.

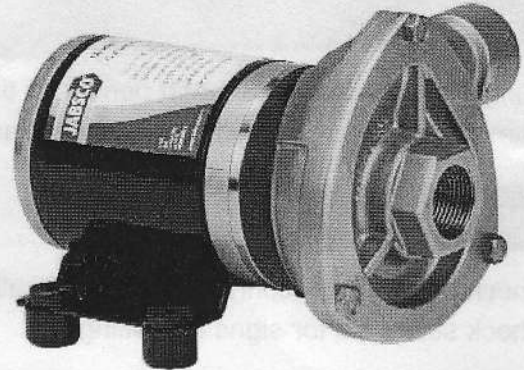

Features & Benefits

- Heavy duty robust design
- Stainless steel construction
- Long life DC motor
- Silent running
- Anti-clog impeller design
- Long life mechanical seal
- Single tool servicing

Specification

- Continuously rated
- Motor life 3500 hours
- 2m suction lift when wet

Relevant Standards

- ISO 8846 MARINE and USCG Regulations for Ignition Protection
- ISO 8849 MARINE Bilge Pump Standard

Performance Curve

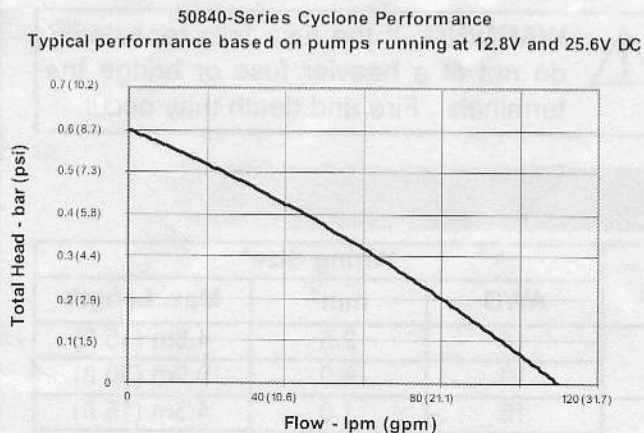

Part Numbers

Model	Voltage	Port Fitting
50840-0012	12Vdc	NPTF
50840-2012	12Vdc	BSP
50840-0024	24Vdc	NPTF
50840-2024	24Vdc	BSP



WARNING: Do not pump petrol or fluids with a flash point below 37°C (98°F). Explosion and death may occur.

Installation Instructions

- The Cyclone can be mounted on any flat surface.
- The pump must be installed below the lowest fluid level to maintain flooded suction.
- Fit pump in a dry, well ventilated position.
- Use rubber grommets provided to minimise vibration.
- If mounted vertically, ensure the motor is above the pump head.
- Use 3/4" pipe fittings with PTFE pipe joint tape or compound.
- Plastic fittings should not be used if pump is installed below the waterline.



WARNING: All marine pumps discharging overboard must be installed with the overboard discharge well above both static and heeled waterlines. Flooding and death may occur.

Operation

- Pump may be run dry for short periods of time.
- Pump may be run against a closed discharge.

Maintenance

- Check all electrical connections periodically.
- Check seal area for signs of leaking.

Spare Parts List

See Exploded View (Page 4) for explanation of parts key

(A) Pump Head Kit (NPT)	50844-0000
Pump Head Kit (BSP)	50844-2000
(B) Seal Kit	50835-0000
(C) Motor Kit (12V)	50836-0012
Motor Kit (24V)	50836-0024

KEY	DESCRIPTION	KIT KEY			QTY PER KIT
		A	B	C	
1	Housing	1			1
2	End Cover	1			1
3	O-Ring	1	1		1
4	Screws	5	5		5
5	Impeller	1			1
6	Seal		1		1
7	Motor			1	1
8	Locking Nut	1	1		1
9	Slinger		1		1



WARNING: Motor may get hot after prolonged use, do not touch. Burns may occur.

Wiring Instructions

- Make all electrical connections in dry locations.
- In humid/wet environments, connections must be sealed to prevent corrosion.
- Protect the circuit with a correctly fitted fuse or circuit breaker in the red/orange positive (+ve) lead, as close as possible to the power source.
- Connect the black negative (-ve) lead to the negative battery terminal.
- Inadequate voltage at the pump (not more than 3% below rated voltage) may result in poor pump performance. See table for wire sizing.

Wiring Diagram

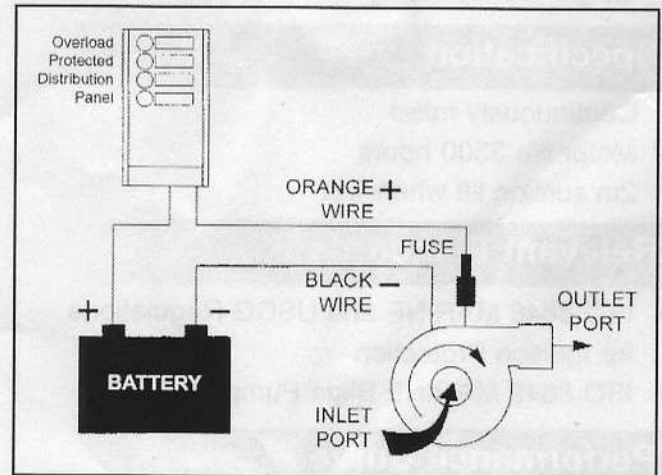

WARNING: If the fuse fails repeatedly, do not fit a heavier fuse or bridge the terminals. Fire and death may occur.

Wire Size Table

Model Number	Voltage	Maximum Current	Fuse Size	Wiring Size*		
				AWG	mm ²	Max. Length
50840-XX12	12V	9.0A	10A	14	2.5	4.5m (15 ft)
				10	6.0	9.0m (30 ft)
50840-XX24	24V	4.5A	7A	18	1.0	4.5m (15 ft)
				16	1.5	9.0m (30 ft)

* wire length from battery to pump and back to battery, maximum voltage drop 3%

Dis - Assembly

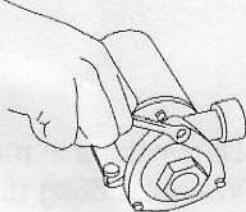
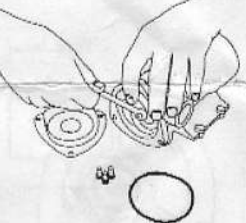
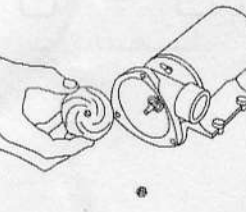
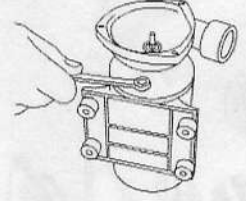
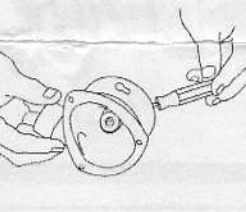
1	Disconnect pump from power supply. Remove 3 end cover bolts, end cover & o-ring.	
2	Carefully holding impeller, remove impeller nut.	
3	Remove impeller.	
4	Loosen 2 head fixing bolts, rotate pump head and pull to remove.	
5	Remove seals from pump body.	

Re - Assembly

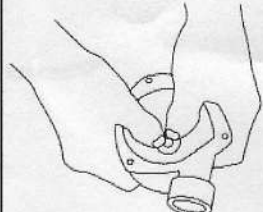
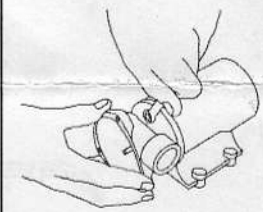
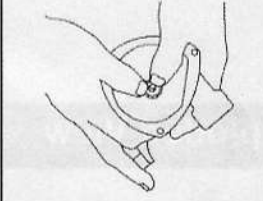
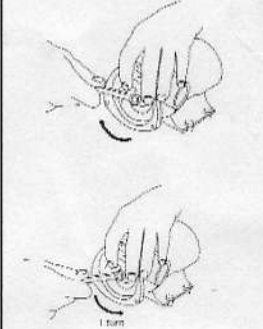
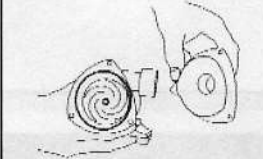
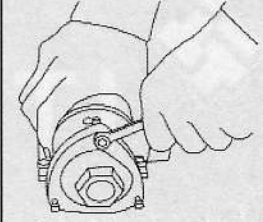
6	Wet the flat seal part and cup rubber and push into head.	
7	Fit head to motor locking into position and tighten head fixing bolts.	
8	Lubricate inside of mechanical seal and push onto shaft.	
9	Fit and carefully hold impeller and tighten nyloc nut. Once tight, carefully hold impeller and undo nut 1 revolution to set impeller clearance.	
10	Fit o-ring to the body, then place on the head.	
11	Tighten 3 end cover bolts.	

Dimensional Drawing

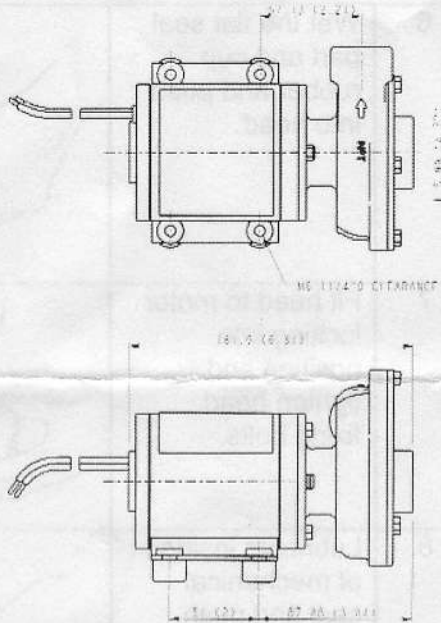

Dimensions in mm (inches)
Weight 2.88kg (6.3lbs)

Exploded View

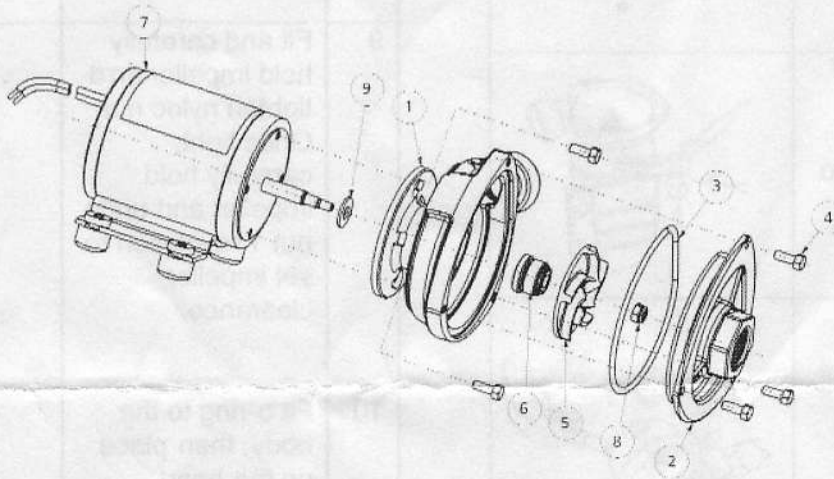

Engineered for life

Jabsco, 1 Kondelin Road, Cape Ann Industrial Park, Gloucester, MA 01930

Tel : +1 978 281 0440 Fax : +1 978 283 2619

Jabsco, Bingley Road, Hoddesdon, Hertfordshire, EN11 0BU

Tel : +44 (0)1992 450145 Fax : +44 (0)1992 467132

Fluid Products Canada, 55 Royal Road, Guelph, Ontario N1H 1T1

Tel : +1 519 821 1900 Fax : +1 519 821 5316

NHK Jabsco Co Ltd, 3-21-10, Shin - Yokohama, Kohoku-ku, Yokohama 222

Tel : +81 (0) 45 475 8906 Fax : +81 (0) 45 475 8908

Jabsco GmbH, Oststraße 28, 22844 Norderstedt

Tel : +49 (0) 40 53 53 73 0 Fax : +49 (0) 40 53 53 73 11

Jabsco Italia, s.r.l., Via Tommaseo, 6, 20059 Vimercate, Milano

Tel : +39 039 685 2323 Fax : +39 039 666 307

USA

UK

CANADA

JAPAN

GERMANY

ITALY