

# FUELMASTER 40 & BY-PASS 40

**JABSCO**

## OPERATING, SERVICE & SAFETY INSTRUCTIONS

- F** FONCTIONNEMENT, ENTRETIEN ET SECURITE
- D** BEDIENUNGS, -WARTUNGS-UND SICHERHEITSHINWEISE
- NL** GEBRUIK, ONDERHOUD EN VEILIGHEIDSVOORSCHRIFTEN
- I** ISTRUZIONE PER L'USO MANUENZIONE E SICUREZZA
- E** INSTRUCCIONES DE OPERACION MANTENIMIENTO Y SEGURIDAD
- S** DRIFT, SERVICE OCH SÄKERHETSINSTRUKTIONER

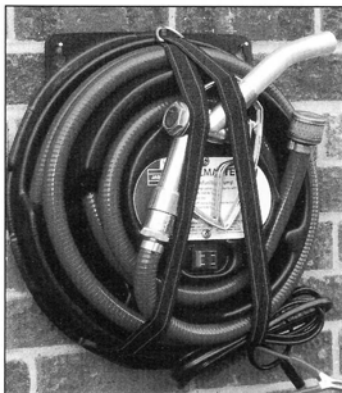

### FUEL MASTER 40

#### Models

50140-0000 12v 50140-0100 24v

50140-0010 12v } With Automatic  
50140-0110 24v } Trigger Nozzle

- F** Avec Pistolet Automatique
- D** Mit Automatischer Zapfpistole
- NL** Met Automatisch Vulpistool
- I** Con Pistola Automatica
- E** Grifo Pistola Automatico
- S** Pistolventil Med Automatisk Avstängning

### BY-PASS 40

#### Models

50130-1000 12v 50130-1100 24v

50130-1200 12v } With Switch  
50130-1300 24v } and Fuse

- F** Avec Inerrupteur et Fusible
- D** Mit Schakelaar und Sicherung
- NL** Met Schakelaar en Zekring
- I** Con Interruttore e Fusibile
- E** Con Fusibile y Interruptor
- S** Med Strömbrytare och Säkring

# FUELMASTER 40 & BY-PASS 40

OPERATION: FONCTIONNEMENT: BEDIENUNG: GEBRUK:  
 ISTUZIONE PER L'USO: INSTRUCCIONES DE OPERACION: DRIFT

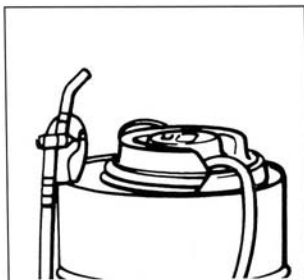

**Mounting**  
*Montage*  
**Zusammenbau**  
*Montage*  
**Montaggio**  
*Montaje*  
**Montering**

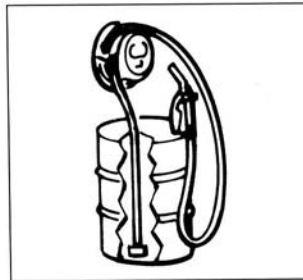
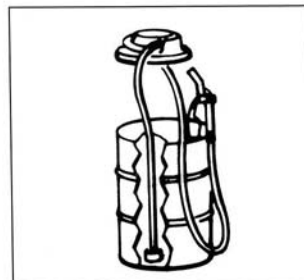

**Installation**  
*Installation*  
**Installation**  
*Installatie*  
**Installazione**  
*Instalacion*  
**Installation**

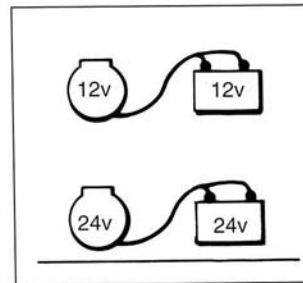
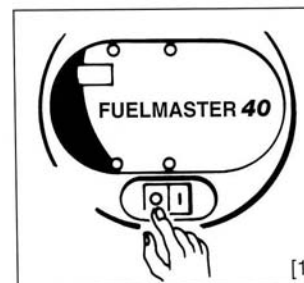

**Ensure switch is "OFF"**  
*Verifier que l'interrupteur est "OFF"*  
**Schalter muß AUS (off) anzeigen**  
*Verzeker u ervan dat de schakelaar op "off" staat*  
**Assicurare che l'interruttore sia spento**  
*Asegurarse que el interruptor este apagado*  
**Se till att brytaren är avslagen**

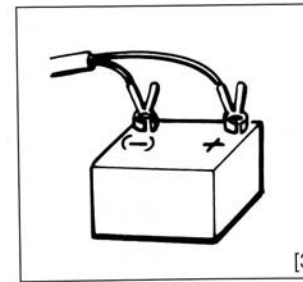
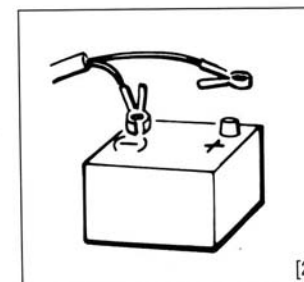

**Connect Negative 1st & Positive 2nd**  
*Brancher le negatif en premier, Puis le positif*  
**Zuerst Minus, dann Plus-Pol anschliessen**  
*Sluit eerst de "min" kabel aan, daarna de "plus" kabel*  
**Collegare prima il negativo e secondo il positivo**  
*Conectar primero el negativo y segundo el positivo*  
**Anslut först negativ, sedan positiv**

# FUELMASTER 40 & BY-PASS 40

Flow rate	35 ltrs/min (9.30 US gal) @ 2 mtrs HD (6.5 ft) @ 20°C ambient (68°C)
Maximum Current Draw	12v Models - 20 amps (fuse rating)
	24v Models - 10 amps (fuse rating)
Normal Current Draw @ 2 Metres Head (6.5 ft)	12v Models - 13 amps
	24v Models - 6 amps

Debit	35 ltrs/min @ 2 mtrs HD @ 20°C ambient
Amperage Maxi.	12v Models - 20 amps (Taille des fusibles)
	24v Models - 10 amps (Taille des fusibles)
Amperage Normal a HMT 2 metres	12v Models - 13 amps
	24v Models - 6 amps

Fördermenge	35 ltrs/min @ 2 mtrs HD @ 20°C ambient
Max. Leistungsaufnahme	12v Models - 20 Amp (Sicherungs-Schmelzpunkt)
	24v Models - 10 Amp (Sicherungs-Schmelzpunkt)
Leistungsaufnahme bei 2m Druckhöhe	12v Models - 13 Amp
	24v Models - 6 Amp

Stroomsnelheid	35 ltrs/min @ 2 mtrs HD @ 20°C ambient
Maximum Stroomafname	12v Models - 20 amps (Zekering belasting)
	24v Models - 10 amps (Zekering belasting)
Normal Stroomafname bij 2 m opvoerhoogte	12v Models - 13 amps
	24v Models - 6 amps

Portata	35 ltrs/min @ 2 mtrs HD @ 20°C ambient
Amperaggio Massimo	12v Models - 20 amps (Fussibile)
	24v Models - 10 amps (Fussibile)
Amperaggio Massimo a 2 metri diprevalenza	12v Models - 13 amps
	24v Models - 6 amps

# FUELMASTER 40 & BY-PASS 40

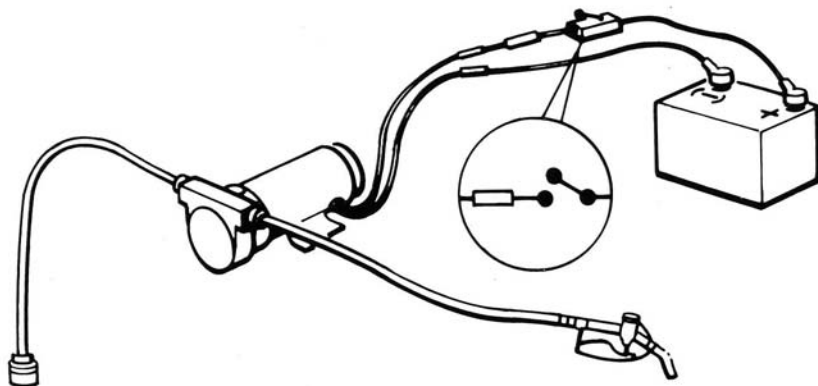

Switch and fuse must be fitted. See technical specification for fuse size  
*L'interrupteur et le fusible doivent être montés. Voir spécification technique*  
 Schalter und Sicherung müssen installiert sein. Siehe technische Beschreibung  
 Schakelaar en zekering moeten geplaatst zijn. Zie technische specificaties  
 L'interruttore ed il fusibile debbono essere montati. Vedere la schedatecnica  
 Interruptor y fusibles deben semontados. Ver especificacion tecnica  
 Brytare och säkring måste anslutas. Se teknisk specifikation

**SERVICE: ENTRETIEN: WARTUNG: ONDERHOUD: MANUTENZIONE: SERVICE**

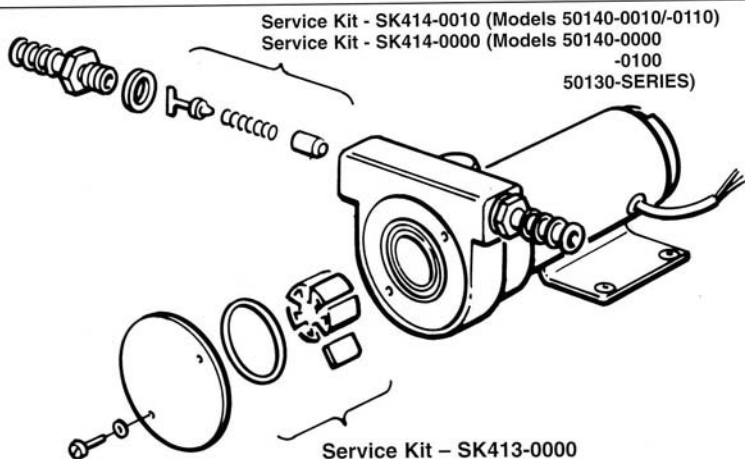

# FUELMASTER 40 & BY-PASS 40

SAFETY: SECURITE: SICHERHEITSHINWEISE: VEILIGHEIDVOORSCHRIFTEN  
SICUREZZA: SEGURIDAD: SÄKERHETSINSTRUKTIONER

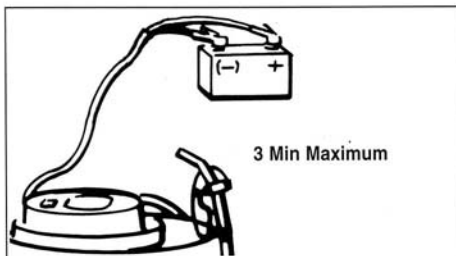

**Maximum by-passing time**

*Durée maximum en BY-PASS*

**By-Pass-Laufdauer**

*Maximum overstort tijd*

**Massimo uso del by-pass**

*Usa continuo by-pass maximo*

**Max by-passtid**

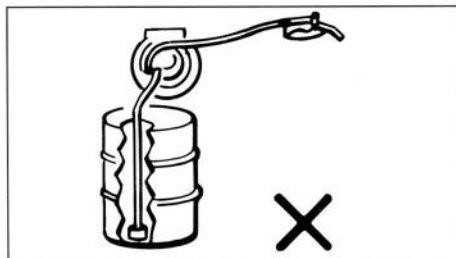

**Do Not Run Dry**

*Ne pas fonctionner à sec*

**Nicht trocken laufen lassen**

*Laat de pomp niet drooglopen*

**Non funzionare in secco**

*No funcionar en seco*

**Får ej torrköras**

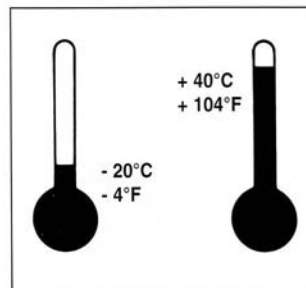
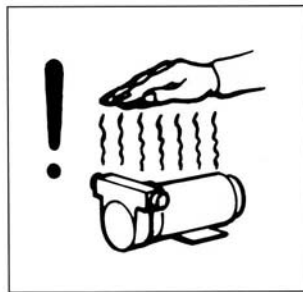
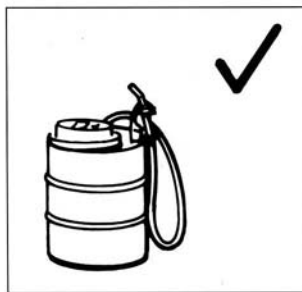

**Temperature Range**

*Température*

**Temperaturbereich**

*Temperatuur bereik*

**Gamma di temperature**

*Temperaturas*

**Temperaturområde**

# FUELMASTER 40 & BY-PASS 40

SAFETY: SECURITE: SICHERHEITSHINWEISE: VEILIGHEIDSVOORSCHRIFTEN  
 SICUREZZA: SEGURIDAD: SÄKERHETSINSTRUKTIONER

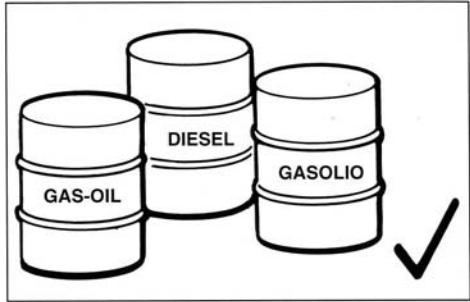
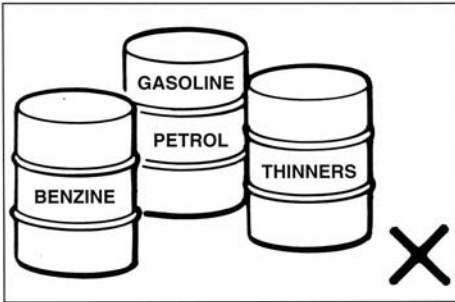

**Flashpoint below 37°C (99°F)**  
*Point éclair en dessous 37°C*  
**Flammpunkt unter 37°C**  
*Viampunt beneden 37°C*  
**Punto d'infiammazione ameno di 37°C**  
*Punto de inflamacion a menos de 37°C*  
**Flampunkt under 37°C**

**Flashpoint above 37°C (99°F)**  
*Point éclair au dessus 37°C*  
**Flammpunkt über 37°C**  
*Viampunt boven 37°C*  
**Punto d'infiammazione piu di 37°C**  
*Punto de inflamacion a mas de 37°C*  
**Flampunkt över 37°C**

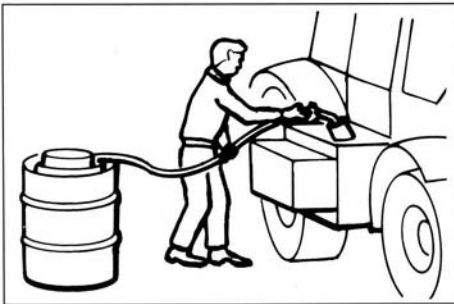

**Maximum duty time**  
*Durée de fonctionnement maximum*

**Einsatzdauer bis max.**  
*Maximum draaitijd*

**Massimo uso ininterrotto**  
*Usa continuo maximo*

**Max drifttid**

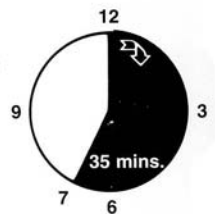

**Maximum total head**  
*HMT maximum*  
**Druckhöhe bis max.**  
*Maximum totale opvoerhoogte*  
**Prevalenza massima**  
*Presion maxima en metros*  
**Max total tryckhöjd**

**Maximum self priming height**  
*Hauter maximum d'amorçage*  
**Selbstansaugend bis max**  
*Maximum zelfaanzulgende hoogte*  
**Massimo autoadescamento**  
*Autocebamiento maximo*  
**Max självsugningshöjd**

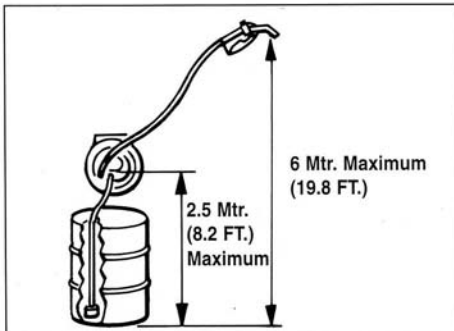

# FUELMASTER 40 & BY-PASS 40



[4]

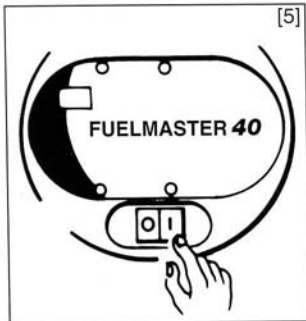

[5]

**Insert nozzle in tank**  
*Placer le pistolet dans le réservoir*  
**Zapfhahn in de Tank einführen**  
*Plaats de uitlooptuit in de tank*  
**Inserire la pistola erogatrice nel serbatoio**  
*Inserir la pistola en el tanque*  
**Sätt in munstycke i tank**

**Switch pump "on"**  
*Mettre la pompe en "on"*  
**Pumpe einschalten**  
*Schakel de pomp aan op "on"*  
**Accendere la pompa**  
*Encender la bomba*  
**Starta pumpen**

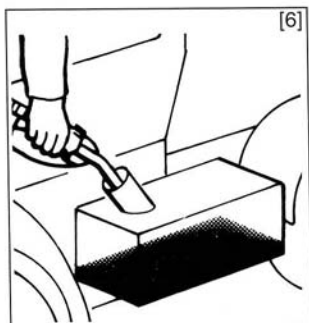

[6]

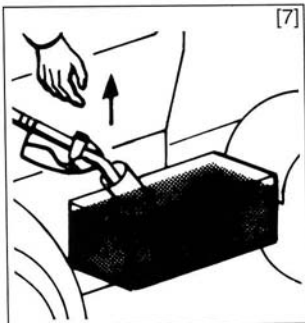

[7]

**Fill tank**  
*Remplir le réservoir*  
**Tank füllen**  
*Vul de tank*  
**Riempire il serbatoio**  
*Llenar el tanque*  
**Fyll tank**

**Release trigger when full**  
*Oter le pistolet quand le réservoir est plein*  
**Wenn Tank befüllt, zapfhahn herausnehmen**  
*Laat de trekker van het vulpistool los als de tank gevuld is*  
**Rilasciare la pistola erogatrice quando il serbatoio è pieno**  
*Quitar la pistola cuando el tanque este lleno*  
**Släpp munstycket när tanken är full**



[8]

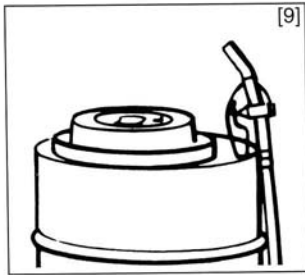

[9]

**Standby position**  
*Position d'attente*  
**Bereitstellung**  
*"Stand by" positie*  
**Stand by**  
*Espera*  
**Startklar**

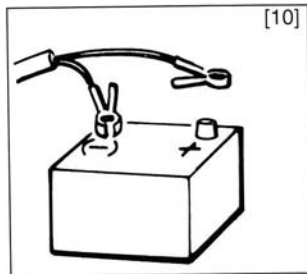

[10]

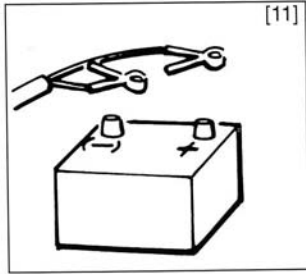

[11]

**Disconnect positive lead 1st & negative 2nd**  
*Debrancher le positif en premier et puis le negatif*  
**Zuerst Plus-, dann Minus-Pol abklemmen**  
*Ontkoppel eerst de "plus" kabel, dan de "min" kabel*  
**Sconnettare prima il positivo e secondo il negativo**  
*Desconectar primero el positivo y segundo el negativo*  
**Ta bort positiv först, sedan negativ**

## FUELMASTER 40 & BY-PASS 40

Caudal	35 ltrs/min @ 2 mtrs HD @ 20°C ambient
Amperaje Maximo	12v Models - 20 amps (Tipo de fusible)
	24v Models - 10 amps (Tipo de fusible)
Amperaje a 2 metros de presion	12v Models - 13 amps
	24v Models - 6 amps

Flödesområde	35 ltrs/min @ 2 mtrs HD @ 20°C ambient
Märkström	12v Models - 20 amps (Säkringsstorlek)
	24v Models - 10 amps (Säkringsstorlek)
Normal strömförbrukning, 2 metres uppfordringshöjd	12v Models - 13 amps
	24v Models - 6 amps

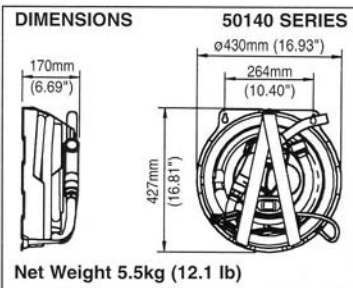
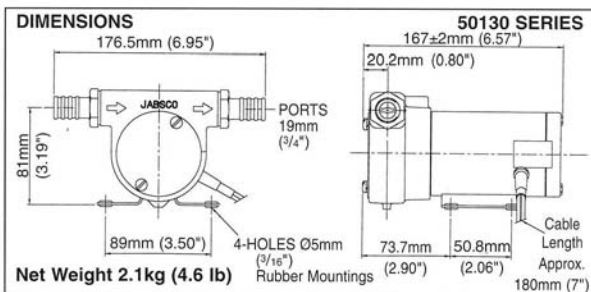

Distributed By

### QUALITY

ITT Jabsco is a quality assured manufacturer approved by BSI to ISO 9001. Certificate No. FM01738.



Jabsco



ITT Industries

Jabsco, 20 Icon, Foothill Ranch, CA 92610  
 Tel : + 1 949 609 5106 Fax : + 1 949 859 1254

Jabsco, Bingley Road, Hoddesdon, Hertfordshire, EN11 0BU  
 Tel : +44 (0) 1992 450 145 Fax : +44 (0) 1992 467 132

Fluid Products Canada, 55 Royal Road, Guelph, Ontario N1H 1T1  
 Tel : +1 519 821 1900 Fax : +1 519 821 5316

NHK Jabsco Co Ltd, 3-21-10, Shin - Yokohama, Kohoku-ku, Yokohama 222  
 Tel : +81 (0) 45 475 8906 Fax : +81 (0) 45 475 8908

Jabsco GmbH, Oststraße 28, 22844 Norderstedt  
 Tel : +49 (0) 40 53 53 73 0 Fax : +49 (0) 40 53 53 73 11

USA

UK

CANADA

JAPAN

GERMANY

Warranty: All products of the company are sold and all services of the company are offered subject to the company's warranty and terms and conditions of sale, copies of which will be furnished upon request. The information provided herein is for guidance only, it does not constitute a guarantee of the performance or specification of any individual product or component.