

JABSCO®

WATER SYSTEM PUMPS

- 31595-SERIES
- 31600-SERIES
- 31620-SERIES
- 31630-SERIES

PAR-MAX 2+ – 2.8 GPM (10.6 LPM)
PAR-MAX 3 – 3.5 GPM (13.2 LPM)
PAR-MAX 4 – 4.3 GPM (16.3 LPM)

FEATURES

- Self-Priming to 10 ft. (3 m)
- Runs Dry Without Damage
- Smooth Flow
- Four Piston, Diaphragm Pump
- Powerful Motor with Thermal Overload Protection
- Snap-in Ports
- Waterproof Coating (31630-Series)
- Pressure Switch with Rubber Boot
- Meets USCG Regulation 183.410 and EN ISO 8846 MARINE (Ignition Protection)
- Meets EN 50081-1 Electro-magnetic Compatibility



APPLICATIONS

The PAR-MAX Automatic Water System Pump is designed for self-contained boats and RV's with multiple fixture water systems. The system operates automatically. When a fixture is opened, the pump instantly begins operation to provide a smooth constant flow from tank to faucet. Closing the faucet automatically discontinues pump operation.

The Deluxe model 31630-Series has a corrosion resistant coated motor for extra protection in harsh environment applications.

SPECIFICATIONS

- Pump Body – Glass Filled Polypropylene
- Pump Design – Multi-Chamber Diaphragm
- Suction Lift – Self Priming to 10 ft. (3 m)
- Ports – 1/2" (13 mm) Hose & 1/2" (13 mm) Threaded (QEST Type)
- Motor – Permanent Magnet
- Shipping Weight – 3.9 lb (1.8 kg) 31595-Series
4.5 lb (2.1 kg) 31600-Series
6.0 lb (2.8 kg) 31620-Series
31630-Series

Models 31595, 31600, 31620, 31630-Series

MODEL	GPM/LPM	VOLTS	NOMINAL psi (bar)		AMP DRAW @ 10 psi	FUSE/BREAKER*
			CUT-IN	CUT-OUT		
31595-0092	2.8/10.6	12 Vdc	20 (1.4)	40 (2.8)	4	10
31595-0094	2.8/10.6	24 Vdc	20 (1.4)	40 (2.8)	2	7
31595-0292	2.8/10.6	12 Vdc	10 (0.7)	25 (1.8)	4	10
31595-0294	2.8/10.6	24 Vdc	10 (0.7)	25 (1.8)	2	7
31600-0092	3.5/13.2	12 Vdc	20 (1.4)	40 (2.8)	5	10
31600-0094	3.5/13.2	24 Vdc	20 (1.4)	40 (2.8)	3	7
31600-0292	3.5/13.2	12 Vdc	10 (0.7)	25 (1.8)	5	10
31600-0294	3.5/13.2	24 Vdc	10 (0.7)	25 (1.8)	3	7
31620-0092	4.3/16.3	12 Vdc	20 (1.4)	40 (2.8)	6	10
31620-0094	4.3/16.3	24 Vdc	20 (1.4)	40 (2.8)	3	7
31620-0292	4.3/16.3	12 Vdc	10 (0.7)	25 (1.8)	6	10
31620-0294	4.3/16.3	24 Vdc	10 (0.7)	25 (1.8)	3	7
31630-0092	4.3/16.3	12 Vdc	20 (1.4)	40 (2.8)	6	15

* Customer supplied, not included with pump.

DIMENSIONAL DRAWINGS — INCHES (MILLIMETRES)

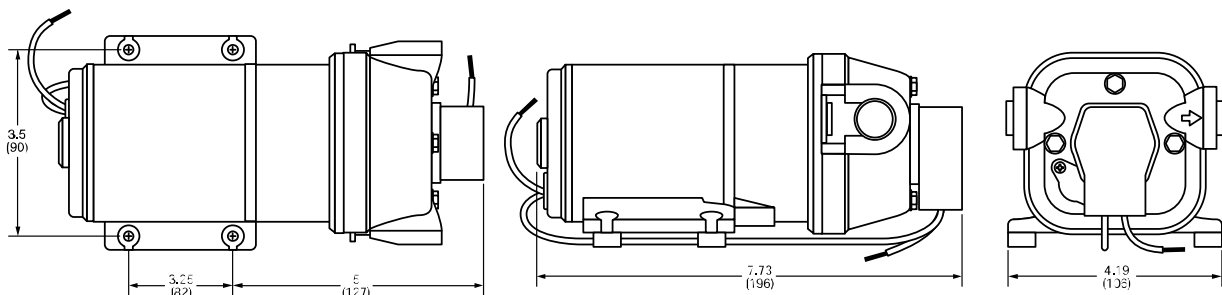

INSTALLATION



MOUNTING

The PAR-MAX pumps are self-priming and may be located above or below the fresh water tank in a dry location. To vertically mount these units, it is best to do so with the motor on top. This will prevent water dripping on motor in the event of a leak. **Place pump on a solid surface and secure with four mounting screws (not included) being careful not to compress the rubber grommets which act as shock absorbers.**

PLUMBING

Select two of the port adaptors supplied to match your plumbing system. **Flexible potable water hose or PEX tubing is recommended instead of rigid piping at pump.** If you choose to use rigid piping, provide a short length of hose between pipe and the pump to avoid noise and vibration. Use clamps at both ends of hose to prevent air leaks into the water line. NOTE: Intake hose must be minimum 1/2" (13 mm) ID reinforced hose. Main distribution line from pump outlet should also be 1/2" (13 mm) ID with branch and individual supply lines to outlets no smaller than 3/8" (10 mm). A Jabsco "Pumpgard" in line strainer should be installed between pump and tank to keep debris out of pump and system. Fresh water tank must be vented. Avoid any kinks or fittings which could cause excessive restrictions. Remember to periodically clean faucet and "Pumpgard" screens.

WARNING!



Explosion hazard. Do not pump gasoline, solvents, thinners or other flammable liquids. To do so can cause an explosion resulting in injury or death.

WIRING

In an easily accessible location, install a switch (Jabsco 44960-Series) to control electricity to the pump. Turn the pump off when not used for extended periods or when the tank is empty.

The electrical circuit should be protected with an over-current protection device in the positive lead. See chart for proper size. The pump circuit should not include any other electrical loads. The free lead at the pressure

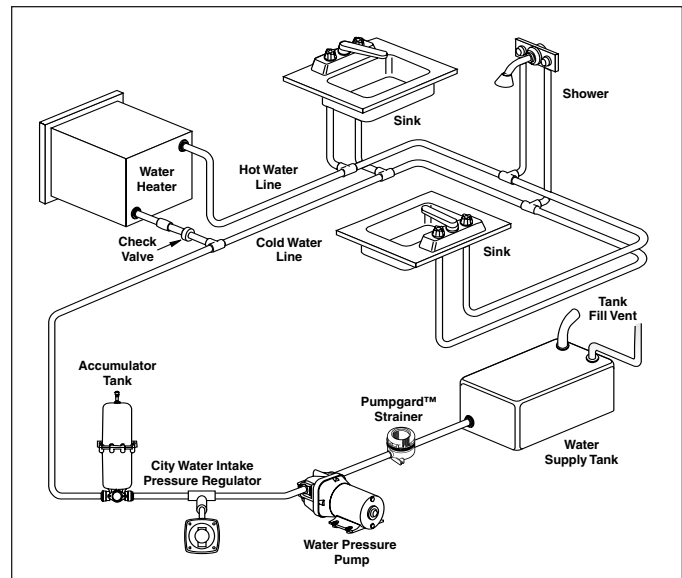

switch is positive. Black wire from the motor is negative.

Select wire size from chart below. Use total length of wire from the battery to pump and return. Chart allows for 3% voltage drop. If in doubt, use next larger wire size.

Total length in feet	0-20 (0-6 m)	20-35 (6-11 m)	35-55 (11-17 m)
12 Volt	#14 AWG (2.5 mm ²)	#12 AWG (4 mm ²)	#10 AWG (6 mm ²)
24 Volt	#16 AWG (1.5 mm ²)	#14 AWG (2.5 mm ²)	#12 AWG (4 mm ²)

WARNING

Fire hazard. Wiring must comply with applicable electrical standards and include a properly sized fuse or circuit breaker. Improper wiring can cause a fire resulting in injury or death.

If you are not familiar with applicable electrical standards, have the unit installed by a qualified electrician.

After installation, check the voltage at the pump motor. Voltage should be checked when pump is operating. Full voltage must be available at the pump motor at all times.

OPERATION

1. Check level of water in tank.
2. Open all faucets hot and cold.
3. Switch on power to pump and wait for hot water tank and water lines to fill.
4. Close each faucet as flow becomes steady and free of air (close cold water faucet first). Pump should shut off soon after closing last faucet.
5. Pump is now ready for automatic operations. It will start when faucet is opened and stop when faucet is closed.
6. If pump will be inoperative for a considerable length of time, turn off circuit to pump and bleed system by opening faucet.

CAUTION

Motor case will get hot. Prolonged contact during operation may cause a burn.



WARNING: DISCONNECT POWER TO PUMP AND OPEN VALVE TO RELIEVE WATER PRESSURE PRIOR TO SERVICING PUMP

EXPLODED VIEW

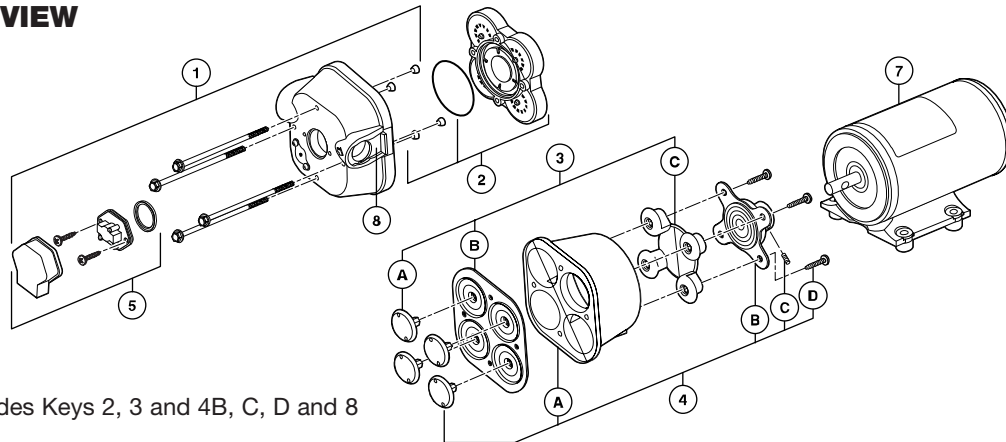

* Service kit includes Keys 2, 3 and 4B, C, D and 8

KEY	DESCRIPTION	QTY	31595-SERIES	31600-SERIES	31620-SERIES	31630-SERIES	
1	Upper Housing	XXXXX-0092	1	18910-4040	18910-4040	18910-4040	18910-4040
		XXXXX-0094	1	18910-4040	18910-4040	18910-4040	18910-4040
		XXXXX-0292	1	18910-4025	18910-4025	18910-4025	18910-4025
		XXXXX-0294	1	18910-4025	18910-4025	18910-4025	18910-4025
		XXXXX-0294	1	18910-4025	18910-4025	18910-4025	18910-4025
2	Valve Kit	1	18911-7030	18911-7030	18911-7030	18911-7030	
3	Diaphragm Kit	1	18912-3040	18912-3040	18912-3040	18912-3040	
4	Lower Housing Kit	1	18915-9000	18915-9002	18915-9002	18915-9002	
5	Pressure Switch	XXXXX-0092	1	18916-0040	18916-0040	18916-0040	18916-0040
		XXXXX-0094	1	18916-0040	18916-0040	18916-0040	18916-0040
		XXXXX-0292	1	18916-0025	18916-0025	18916-0025	18916-0025
		XXXXX-0294	1	18916-0025	18916-0025	18916-0025	18916-0025
		XXXXX-0294	1	18916-0025	18916-0025	18916-0025	18916-0025
*6	Service Kit	1	18920-9042	18920-9043	18920-9043	18920-9043	
7	Motor Kit – 12V EMC COMP	18919-0134	1	18919-0134	18919-0132	18919-0133	
		24V EMC COMP	1	18919-1055	18919-1052	18919-1053	N/A
8	Slide Clips	1	30648-1000	30648-1000	30648-1000	30648-1000	
9	Pumphead Assy.	XXXXX-0092	1	18914-6240	18914-6340	18914-6340	18914-6340
		XXXXX-0094	1	18914-6240	18914-6340	18914-6340	18914-6340
		XXXXX-0292	1	18914-6225	18914-6325	18914-6325	18914-6325
		XXXXX-0294	1	18914-6225	18914-6325	18914-6325	18914-6325
		XXXXX-0294	1	18914-6225	18914-6325	18914-6325	18914-6325

DISASSEMBLE

Pressure Switch (5)

1. Disconnect power to pump and open a faucet or valve to relieve system pressure.
2. Remove Rubber Boot, then remove the two visible Pressure Switch Screws located on each side of the Pressure Switch (5).

Upper Housing (1)

3. Slide Port Clip (8) back and unplug from Tank Plumbing.
4. Loosen but DO NOT remove the four Pump Head Screws and carefully remove Upper Housing Assembly (1).
5. Remove Check Valve (2) and inspect for debris.

Check Valve Assembly (2) Follow Steps 1, 3 & 4

6. Inspect Check Valve (2) and O-Ring

Lower Housing (4) Follow Step 1, 3 & 4

7. Remove Rubber Plugs on housing (4-A) to access Allen Screw.
8. Rotate Lower Housing (4), so access notch is aligned with Cam Bearing Set Screw (4-C), loosen set screw with a 1/8" Allen Wrench and slide pump head off motor shaft.

Diaphragm (3-B)

9. Loosen four cam piston screws with Phillips head screw driver and pull apart cam (4-B) from Inner Pistons (3-A). (Both pistons (3-A & C) should be replaced when a new Diaphragm (3-B) is installed.)

Motor (7) Follow steps 1, 3, 4, 7, & 8

REASSEMBLE

Diaphragm (3-B)

1. Insert Outer Pistons (3-C) into Lower Housing (4-A) by bending pistons at center fold.
2. Placing the Diaphragm (3-B) (flatter side of Diaphragm facing the motor) on the Lower housing (4-A). Press each Inner Piston (3-A) through the Diaphragm and Lower Housing (4A) into Outer Piston (3-C). Hex stem of Inner Pistons (3-A) must be aligned into hex holes in Outer Pistons (3-C). Tighten cam piston screws partially, center piston in diaphragm, and tighten screws securely (18 in. lbs. torque). Also, the Outer Pistons (3-C) must be aligned with alignment slots on Cam Assembly (4-B) making sure screw holes align in cam assembly, otherwise diaphragm will leak.

Cam Bearing (4-B)

3. Place Cam Bearing (4-B) over Inner Pistons (3-C) and tighten down with four Phillips Head Screws. (18 in. lbs. torque)

Lower Housing (4) to Motor (7)

- Coat motor shaft with grease prior to installing Cam Bearing (4-B).
4. When installing the Lower Housing (4), rotate access notch to align with Cam Bearing Set Screw (4-C).
5. Attach Cam Bearing (4-B) to motor shaft indentation with Cam Bearing Set Screw (4-C). (35 in. lbs. torque)
6. Reinsert new Notch Plugs.

Check Valve (2)

7. Place Ferrules (Rubber Cones) in the Upper Housing (1) coned side first.
8. Properly seat O-Ring in Check Valve (2) and insert Check Valve (2) into the Upper Housing (1).

Upper Housing (1)

9. Place Upper Housing (1) on top of the Lower Housing (4-A) and tighten Hex Bolts (30 in. lbs. torque) through the Upper Housing (1) to the Motor.

TROUBLESHOOTING

PULSATING FLOW – PUMP CYCLES ON AND OFF

- Restricted pump delivery. Check discharge lines, fittings and valves for undersizing or clogging. Clean screens in faucets. Some filters or purifiers are highly restrictive. Filters/purifiers with high pressure drop may require a separate line and the installation of an accumulator tank in the system.

FAILURE TO PRIME – MOTOR OPERATES, BUT NO PUMP DISCHARGE

- Restricted intake or discharge line.
- Air leak in intake in line.
- Punctured pump diaphragm (water leak).
- Debris under flapper valves.
- Crack in pump housing.

MOTOR FAILS TO TURN ON

- Loose wiring connection.
- Pump circuit has no power.
- Blown fuse/Thermal Protector tripped (wait 30 min.).
- Pressure switch failed.
- Defective motor.

⚠ CAUTION PAR-MAX pumps have thermal overload protected motors. The motor will automatically shut off as temperature rises due to an overload condition. If the motor shuts off in this manner, close all nozzles, faucets or valves. After a cooling off period, the pump will automatically re-start.

WINTERIZING YOUR WATER SYSTEM

To winterize, it is not necessary to drain the water from the entire water system. Blowing into the lines to remove the water from your water system is not satisfactory due to the check valve mechanism built into the pump.

Follow these steps to remove all water from your water system:

1. Drain water by opening tank drain, or open a fixture to allow pump to operate until tank is dry.

⚠ DANGER DO NOT USE AUTOMOTIVE TYPE ANTI-FREEZE. IT IS POISONOUS. USE OF THIS TYPE ANTI-FREEZE WILL CAUSE SERIOUS INTERNAL INJURY OR DEATH.

ACCESSORIES

SNAP-IN PORT SYSTEM

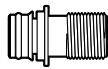

30649-1000
30649-1001
SNAP-IN PORT x
1/2" MALE QEST.
STRAIGHT

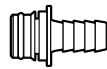

30654-1000
30654-1001
SNAP-IN PORT x
1/2" HOSE BARB
STRAIGHT

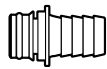

30653-1000
30653-1001
SNAP-IN PORT x
3/4" HOSE BARB
STRAIGHT

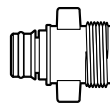

30650-1000
30650-1001
SNAP-IN PORT x
GARDEN HOSE
STRAIGHT

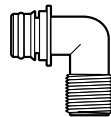

30655-1000
30655-1001
SNAP-IN PORT x
1/2" MALE QEST.
90° ELBOW

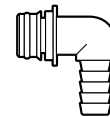

30651-1000
30651-1001
SNAP-IN PORT x
1/2" HOSE BARB
90° ELBOW

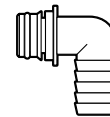

30642-1000
30642-1001
SNAP-IN PORT x
3/4" HOSE BARB
90° ELBOW

PUMP FAILS TO TURN OFF AFTER ALL FIXTURES ARE CLOSED

- Empty water tank.
- Punctured pump diaphragm (water leak).
- Discharge line leak.
- Defective pressure switch.
- Insufficient voltage to pump.
- Debris under flapper valves.

LOW FLOW AND PRESSURE

- Air leak at pump intake.
- Accumulation of debris inside pump and plumbing.
- Worn pump bearing (excessive noise).
- Punctured pump diaphragm (water leak).
- Defective motor.

2. Open the lowest outlet in water system to drain lines.
3. To remove any remaining water (about a cup), remove outlet hose on pump and activate pump. To blow out lines, attach air nozzle where outlet hose was removed. Make sure all fixtures are open before starting.
4. Your water system is now winterized. Don't forget to reattach the outlet hose to pump and close all fixtures.

Jabsco



ITT Industries
Engineered for life

THE PRODUCTS DESCRIBED HEREIN ARE SUBJECT TO THE JABSCO ONE YEAR LIMITED WARRANTY, WHICH IS AVAILABLE FOR YOUR INSPECTION UPON REQUEST.

U.S.A.
Jabsco
20 Icon
Foothill Ranch, CA 92610-3000
Tel: 949.609.5106
Fax: 949.859.1254

UNITED KINGDOM
Jabsco
Bingley Road, Hoddesdon
Hertfordshire EN11 0BU
Tel: +44 (0) 1992 450145
Fax: +44 (0) 1992 467132

CANADA
Fluid Products Canada
55 Royal Road
Guelph, Ontario N1H 1T1
Tel: (519) 821.1900
Fax: (519) 821.2569

JAPAN
NHK Jabsco Company Ltd.
3-21-10, Shin-Yokohama
Kohoku-Ku, Yokohama, 222
Tel: 045.475.8906
Fax: 045.475.8908

GERMANY
Jabsco GmbH
Oststrasse 28
22840 Norderstedt
Tel: +49-40-53 53 73 -0
Fax: +49-40-53 53 73 -11