

Ballast King DC Flexible Impeller Pump

CE



a xylem brand

Ballast King DC Flexible Impeller Pump

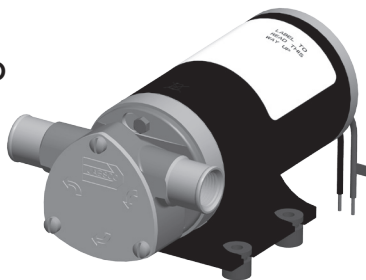

Contents

- 1.0 Introduction
- 2.0 Symbols and using this instruction book
- 3.0 Safety Information
- 4.0 Unpack and Contents
- 5.0 Installation
 - 5.1 Pump Set-up
 - 5.2 Pump Assembly and Disassembly
 - 5.3 Electrical Configuration
 - 5.4 Footprint Specifications
- 6.0 Environmental Protection
- 7.0 Product Operation
 - 7.1 Operating Conditions
 - 7.2 Permitted Fluids
 - 7.3 Initial Start-Up
 - 7.4 Storage and Cleaning
- 8.0 Technical Specifications
- 9.0 Maintenance, Service and Customer Repair
- 10.0 Customer Support
- 11.0 Parts and Accessories
- 12.0 EC Declaration of Conformity

1.0 INTRODUCTION

© The copyright of this instruction book is the property of XYLEM. This instruction book is supplied by XYLEM on the express understanding that it is to be used solely for the purpose for which it is supplied. It may not be copied, used or disclosed to others in whole or part for any purpose except as authorised in writing by XYLEM. XYLEM reserves the right to alter, change or modify this document without prior notification.

In the interest of continued development XYLEM reserves the right to alter or modify the design, or assembly process of their products without prior notification.

The Ballast King is a direct current (DC) electrical flexible impeller pump. Depending on what model you have purchased (see section 4, Unpack and Contents), will determine what installations and what applications will be feasible for the pump you have purchased.

2. 0 SYMBOLS AND USING THIS INSTRUCTION BOOK

 Caution, risk of danger. See note or adjacent symbol.

 Caution hot surface

 Caution / risk of electric shock.

 Recyclable packing material.

 Do not dispose of product in normal domestic waste.

 Refer to this instruction book.

3.0 SAFETY INFORMATION

WARNING!

Prior to installation or use, read this installation and operating instructions. Installation and operation must comply with local regulations and accepted codes of good practice.

Only used with specified products. **DO NOT USE WITH LIQUIDS WITH A FLASH POINT BELOW 100°F (38°C) OR USE WHERE FLAMMABLE VAPORS ARE PRESENT.**

This product has been designed for safe operation when used as detailed in accordance with the Manufacturer's instructions.

This manual also contains necessary information for the correct installation. This manual was developed for qualified personnel with suitable training and technical qualification to operate this type of equipment.



NOTE: Failure to use this equipment in accordance with the manufacturer's operating instructions may compromise your basic safety protection afforded by the equipment and may invalidate the warranty / guarantee. The warranty / guarantee does not cover damaged caused by faulty installation or misuse of the equipment. If the recommended safety notices are not strictly observed, it can lead to serious or fatal injuries of personnel and/or material damage.



Failure to observe the recommended safety procedures can lead to material damage.



Only qualified Service personnel should attempt to repair / service the product.



Do not immerse any part of this machine in water / fluid.



Do not operate the machine without appropriate piping attached.



Do not run the machine without suitable supervision as established for safe working practices and company procedures.



Not to be used by children and non-authorized personnel.



Please keep this manual carefully and available to all operators.



Always follow good working practice when using this equipment.



Follow legislation applicable to your areas of operation.



Do not touch the motor surface during or after operation of the pump as the surface can become hot.



Only use Original Equipment Manufacturer's Parts and Accessories.



The equipment is not spark, flame or explosion proof and has not been designed for use in hazardous areas in terms of the ATEX Directive 94/9/EC.

4.0 UNPACK AND CONTENTS

- When unpacking the product ensure the correct unit is present.
- See 'pump unit information' for guidance on unit selection, information is displayed on the product label indicating which model you have.

Pump Unit Information:

- 22610-9007 - NPT Internal Ports, 12v, 30 minute cycle MAX.
- 22610-2007 - BSP Internal Ports, 12v, 30 minute cycle MAX.

Features

- The pump has been designed to pump fluid into ballast tanks.
- The pump is reversible so it can add liquid ballast, and then pump it overboard when needed.
- When required, the pump is switched on to fill the tank then the pump switched off when full.
- To reduce ballast, the pump will reverse to pump ballast back over board.
- The same operation is used for ballast transfer between two tanks.

5.0 INSTALLATION

5.1 PUMP SET-UP

- Verify that all components are present
- Check the pump unit has not been damaged during transit
- Ensure inlet and outlet ports are free from dirt, dust or packaging material
- Ensure electrical data corresponds to those indicated on the product label and ensure the correct fuse is fitted in the power line (see section 8 for recommended fuses)
- Fit a strainer on the inlet hose to prevent larger debris from entering the pump, ensure this is clean and free from dirt before use.
- Before connecting the inlet and outlet hoses, ensure they are free from dirt.
- Secure 25 mm (1") ID hose either directly to the discharge ports, or to 1/2" BSP/ NPT threaded fittings using stainless steel hose clamps.
- Use spiral reinforced hose (with a smooth internal bore) that will not collapse under suction, or rigid or semi-rigid pipework systems.
- The pump can be mounted on any flat suitable surface.
- Fit the pump in a dry, well ventilated position where there is full access for service.
- Use rubber grommets provided to minimise vibration, do not over tighten the mounting screws.
- All marine pumps discharging overboard must be installed with the overboard discharge well above both static and heeled waterlines.

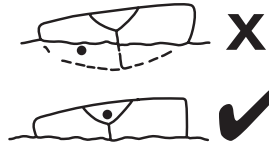

Install overboard discharge well above both static and heeled waterlines.

- The pipework must be compatible with liquid being pumped.

WARNING!

It is the installer's responsibility to use hoses with suitable properties. The use of hose that is not suitable could cause damage to the pump, operator or the surrounding environment. The loosening of hose connections can cause environmental and safety issues. Check all connections after the initial installation and on a daily basis thereafter. Tighten if required. It is recommended the hose is installed prior to installing electrical supply.

WARNING!

Use a medium strength pipe sealant for metal threads.

- Pipe runs should be kept as straight as possible, avoiding rising and dipping over obstructions, shown below.

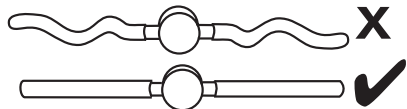

- In order to ensure good priming always keep connections tight.
- Seal leaks should be checked and changed, as leakage could be dangerous, shown below.



- The pump should be installed so that the motor is protected from constant rain, wash down or bilge water.
- The pump should not be run with a closed outlet.
- Please note the pump body can be turned 180 degrees in relation to the motor. This will change the flow direction.

- Install the Ballast King pump in accordance to ISO 10133.
- If installed in a vertical position, the motor must be above the pump head, shown below. This will prevent liquid from dripping onto the motor if there is a seal leak.

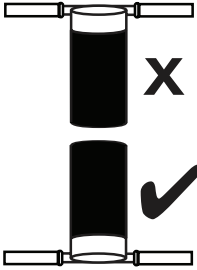

5.2 PUMP ASSEMBLY AND DISASSEMBLY

1. Disassembly

- Back off the end cover screws, re-move the end cover and o-ring.
- Pull out the impeller using a Jabsco impeller removal tool, shown below.
- Back off and remove the screws holding the body to the motor.
- Remove the lip seal from the body.
- Do not disassemble the motor.

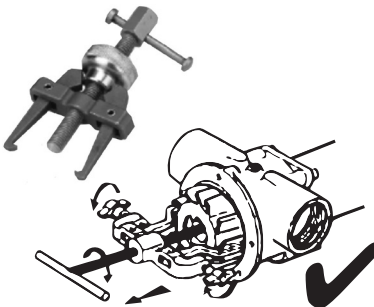
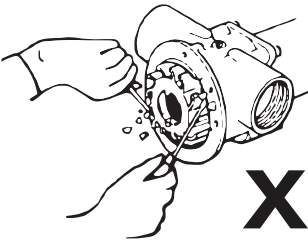

2. Assembly

- Moisten the new lip seal, and mount the seal with the lip facing towards the impeller.
- Lubricate the motor shaft and fit the body to the motor by tightening the motor screws.
- Ensure the body and impeller is lubricated.
- Fit the impeller with a rotating movement in the intended direction of the pump rotation.
- Lubricate the o-ring, fit it in position and fasten the end cover screws to the body.
- Torque value for end cover to body screws: 30 - 40 lbf.ins / 3.4 - 4.5 Nm.
- Torque value for body to motor screws: 21 - 28 lbf.ins / 2.4 - 3.1 Nm.

5.3 ELECTRICAL CONFIGURATION

- It is the responsibility of the installer to perform the correct installation.
- Make all electrical connections in dry locations, connections in humid environments should be sealed to prevent corrosion.
- Protect the circuit with a correctly rated fuse or circuit breaker in the red positive (+) lead as close as possible to the power source (see section 8 for recommended fuses).
- Ensure fuses for the Ballast King pump are slow burning, being capable of handling the start-up and reversing current.
- Connect the black motor wire to the negative (-) battery terminal.
- Inadequate voltage at the motor terminals when the pump is running (not less than 95% below rated voltage at full load) due to partially discharged batteries or insufficient cable size may result in blowing fuses, failure to start or poor pump performance.
- The fuse must be ignition protected.
- The motor is equipped with built in thermal protection to prevent it from over-heating.
- The protection is automatically restored when the motor is cooled.
- Before installation with control systems, check the equipment to be used is of sufficient rated capacity to accept ampere draw of motor.
- Choose the wire size in accordance with total wire length.
- There is a motor thermal cut out switch for protection.
- All Ballast King wiring and connections to be carried out in accordance to ISO 10133.



WARNING!

When terminated at the power supply using permanent connections, red leads should be terminated to the positive and black to the negative. If reversed pump will run in reverse.

5.4 FOOTPRINT SPECIFICATIONS:

- Weight - 3 Kg (6.6 lb).

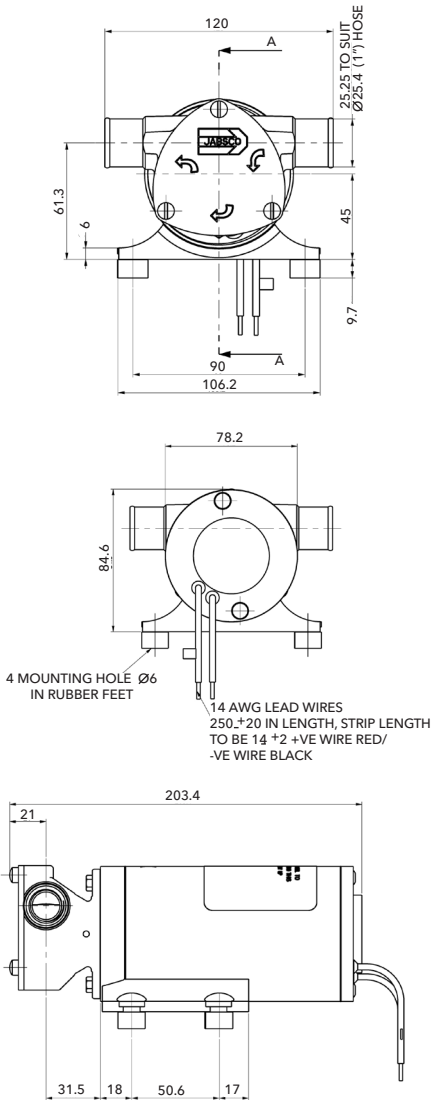

6.0 ENVIRONMENTAL PROTECTION

- Due consideration to environmental issues within the design and manufacturing process of this product without compromising product performance and value.

WEEE Policy

- The Waste Electrical and Electronic Equipment Directive (WEEE Directive) is a European Community Directive 2012/19/EU.
- Xylem Water Services Limited has identified that there product range comes under Category 6 (Electrical tools) and as such will undertake their responsibilities in line with the above directive and will fulfill their legal obligation by means of joining a compliance scheme.
- All products are identified by means of the Wheelie bin logo as laid down in the above directive.



The Water Process Limited WEEE producer registration number is RM07081

Full details of scheme can be found @ Valpak Limited Unit 4

Montague House
Stratford-upon-Avon Business and Technology Park
Banbury Road
Stratford-upon-Avon
Warwickshire
CV37 7GW

- At the end of your product and accessories life, it must not be discarded as domestic waste.
- Please contact your distributor / supplier for further information.
- For end users outside of the EU consult applicable regulations.
- This product should only be dismantled for recycling by an authorized recycling company.
- At the product's end of life please dispose of the product according to the applicable law.
- Where applicable, please disassemble the product and recycle the parts material.

7.0 PRODUCT OPERATION

7.1 OPERATING CONDITIONS

- Maximum ambient temperature is +60 deg. C (140 deg. F), with minimum temperature - 15 deg. C (5 deg. F).
- The life of the impeller depends upon the temperature of the liquid being pumped.
- High and low temperatures can affect impeller life.

7.2 PERMITTED FLUIDS:



- Only use the pump with specified products, including fresh and salt water solutions.
- Do not use any Jabsco pump for petrol, petroleum products or any products with a flash point below 37 deg. C, (98 deg. F), explosion or death may occur, shown below.
- If in doubt about pump material compatibility, consult the website or a sales representative.
- If in doubt about the use of the pump in a potentially explosive atmosphere, consult the website or a sales representative.
- If corrosive products are pumped, pump life will be prolonged if pump is flushed with water at the end of each cycle.



7.3 INITIAL START-UP:

- Complete the installation (as per section 5).
- This is a continuously rated pump for recommended duty cycle of 30 minutes.
- The pump is self-priming to 1.2 m (4 ft).
- Intake lines must be air-tight to ensure self-priming.
- The pump will run dry up to 1 off for 5 minutes.
- Priming may take up to 35 seconds, if priming takes longer than the designated time, check:
 - There are no blockages in the suction hose,
 - The inlet filter is not blocked,
 - The suction pipework is airtight,
 - The height you are priming to falls within the priming capabilities listed in section 7.
- Do not operate any switches with wet hands.
- Never operate a motor which in any way has been manipulated and lost its full enclosure.



WARNING!

The working temperature of the motor may reach a maximum of approx. +80 deg. C (surface temperature) which may burn your skin.

- Motors can spark and explosion and death can occur, with incorrect wiring causing injury or death.

7.4 STORAGE AND CLEANING

- If any pump unit needs to be removed for storage purposes, it must be stored in a cool dry location
- Pump units are rated to IP55. It is recommended that the unit is wiped down after use.
- Liquids must not be allowed to freeze in the pump body, to winterise your system all water must be drained from the entire system, including the pump.

8.0 TECHNICAL SPECIFICATIONS

Total Head (DIFF)		Flow		Current
M	FT	LPM	US GPM	AMPS
0	0	60	16	14
2	7	56	14.8	14.5
4	13	50	13.2	15
6	20	42	11.4	16
8	26	32	8.5	17
10	33	18	4.7	18
12	39	5	1.6	19

Model Number	Voltage (V DC)	Maximum AMP Draw (A)	Minimum Fuse Size (A)	Minimum Wire Size (mm2)	Maximum Total Length Between (+) & (-) Battery Terminals
22610-9007	12.8	19	25	8	4.5
22610-2007	12.8	19	25	8	4.5

- The data specified in the above table refers to performance running at the ideal efficiency points on water at 20 deg. C. with fully charged battery (12.8v).
- The 'MAX AMP DRAW' refers to the pumps running at their maximum pressure, which is past their recommended duty point.
- For longer installations, fit thicker cables (reference ISO 10133).
- The wire length is the total distance from the battery to the pump and back to the battery. It is recommended to use a relay to shorten the main leaders.
- If the fuse fails repeatedly, do not fit a heavier fuse or bridge the fuse terminals with silver paper or metal wire. Failure to observe this instruction may result in a fire hazard due to overheating of cables.
- Exceeding recommended pump discharge pressure will shorten the impeller life.



9.0 MAINTENANCE, SERVICE AND CUSTOMER REPAIR

- The Jabsco Ballast King pump is designed to require minimal amounts maintenance.
- However it is recommended as good practice to:
- Check that all hose connections are not loose and keep the inlet filter clean once a week
- Check the electrical connectors and cables are in good condition once a month

10.0 CUSTOMER SUPPORT

- If any pump units for any reason need to be returned, please ensure the pump unit has been fully drained.
- Please contact customer services for more information.
- No used pumps/ parts will be accepted as returns unless complete details of liquids pumped are supplied.

11.0 PARTS AND ACCESSORIES

- 22610-9007/ -2007 PUMP (NPT OR BSP PORTS)

Item Number	Quantity	Part Number
1	1	23094-9000/ -2000
2	1	98012-9334
3	1	9328-0200
4	2	X3001-147F
5*	1	23095-0107
6	1	23005-2529/ -2530
7*	1	SP2701-52
8	4	92900-0380
9*	1	X5251-049
10	3	SP1004-09
11	1	6342-6000
Minor Service Kit (contains items marked *)		18753-5049

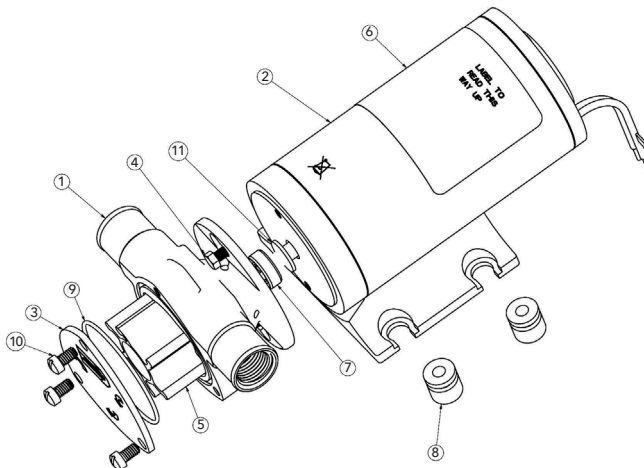
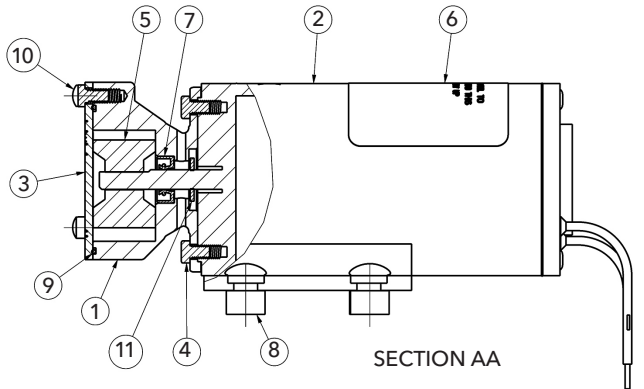

12.0 EC DECLARATION OF CONFORMITY

Declaration of Conformity

In accordance with EN ISO 17050-1:2010

In accordance with the following Directive(s):

2004/108/EC	Electromagnetic Compatibility
2003/44/EC	Recreational Craft Directive
2011/65/EU	RoHS Directive (RoHS 2)
ISO 8846	Small craft Small craft - Electrical devices - Protection against ignition of surrounding flammable gases

hereby declare that: Ballast King 12 V d.c. Flexible Impeller Pump

Equipment /	22610-2007
Model number	22610-9007

is in conformity with the applicable requirements of the following documents:

Directive	Reference Number	Title	Edition/Date
EMC	IEC 60945	Maritime navigation and radio communication equipment and systems. General requirements.	2002
ELVD	BS EN ISO 10133	Small craft - Electrical systems - Extra-Low-Voltage d.c. systems .dc installations	2012
ISO	ISO 8846	Small craft -- Electrical devices -- Protection against ignition of surrounding flammable gases	1990
ENV	EN 60068-2-1	Cold	2007
	EN 60068-2-2	Hot	2007
	EN 60068-2-6	Vibration - General	2008
		Vibration - Resonance	
	EN 60068-2-14	Cycling & Shock	2009
	EN 60068-2-27	Shock & Bump	2006
	EN 60068-2-30	Humidity	2005
	EN 60068-2-31	Drop	2009
	EN 60068-2-52	Salt Mist	2004
EN 60068-2-64	Vibration - Random	2008	
RoHS	RoHS 2 deals with the same six hazardous substances and the same maximum concentration limits as RoHS 1	Lead (0.1%) Mercury (0.1%) Cadmium (0.01%) Hexavalent chromium (0.1%) Polybrominated biphenyls [PBB] (0.1%) Polybrominated diphenyl ethers [PBDE] (0.1%)	2011

Xylem

- 1) The tissue in plants that brings water upward from the roots;
- 2) a leading global water technology company.

We're 12,500 people unified in a common purpose: creating innovative solutions to meet our world's water needs. Developing new technologies that will improve the way water is used, conserved, and re-used in the future is central to our work. We move, treat, analyze, and return water to the environment, and we help people use water efficiently, in their homes, buildings, factories and farms. In more than 150 countries, we have strong, long-standing relationships with customers who know us for our powerful combination of leading product brands and applications expertise, backed by a legacy of innovation.

For more information on how Xylem can help you, go to www.xyleminc.com

UNITED STATES
SA - West Coast
17942 Cowan,
Irvine, CA 92614
Tel: +1 949 608 3900
Fax: +1 949 608 3888

Xylem Analytics
151 Graham Road
College Station
TX 77842
United States of America

GERMANY
Oststraße 28,
22844 Norderstedt, Germany
Tel: +49 (0) 40 53 53 730 Fax: +49
(0) 40 53 53 73 11

ITALY
Via Tommaseo, 6, 20059 Vimercate,
Milano, Italy
Tel: +39 039 6852323
Fax: +39 039 666307

JAPAN
3-21-10 Shin-Yokohama, Kohoku-ku,
Yokohama 222, Japan
Tel: +81 (0) 45 475 8906 Fax: +81
(0) 45 477 1162

CHINA
32/F Tower A, Hongqiao City
Centre of Shanghai,
100 Zunyi Road,
Shanghai 200051, China
Tel: (86)21 2208 2888
Fax: (86)21 2208 2999

xylem
Let's Solve Water

Xylem
Bingley Road, Hoddesdon
Hertfordshire EN11 0BU
United Kingdom
Tel: +44 (0)1992 450145
Fax: +44 (0)1992 467132
www.xyleminc.com

ACCURACY AND COMPLETENESS OF INFORMATION

All information in this literature regarding products and services provided by Xylem brands is subject to change without prior notice. Reasonable efforts are taken to ensure the accuracy and integrity of all information provided here, but Flojet & Alcon is not responsible for misprints, out-of-date information, or errors. Xylem makes no warranty, express or implied, or assumes any legal liability or responsibility for the accuracy or completeness of any information contained in this literature.

December 2014 Part Number: 43010-0325

