



**SELF-PRIMING
MACERATOR PUMP
WITH RUN-DRY PROTECTION**

FEATURES

Pump: Self-Priming Flexible Impeller with
Stainless Steel Wearplate

Impeller: Jabsco Nitrile compound

NEW

Macerator: Stainless Steel Cutter reduces particle
size to 1/8" (3mm) maximum. New 4
blade design.

Seal: Lip Type

Ports: Inlet - 1-1/2" (38mm) Hose Barb
and 1-1/2" N.P.T. (Male)
Outlet - 1" (19mm) Hose Barb

NEW

Motor: Permanent Magnet Type, Fully
Enclosed, with Stainless Steel Shaft
Includes Run-Dry Protection Device
that shuts-off pump. Powder coated
housing with sealed end-bells and bearings.
**Complies with USCG Regulation
183.410 and ISO 8846 MARINE for
Ignition Protection.**

Weight: 5 lb (2.3 kg) Approx.

SPECIFICATION



Priming - 5ft When Wet
4ft When Dry

HEAD CAPACITY AND FLOW RATES

Head Ft	Meters	GPM	Liters	AMPS	
				12 Volt	24 Volt
0	0	12.5	47	14.0	7.6
5	1.5	11.5	44	14.5	7.8
10	3	10.5	40	15.0	8.1
15	4.5	9.0	34	16.0	8.6
20	6	7.5	28	16.5	8.9

† Flow rates and amperage will vary slightly depending on
pump loading (sanitation system design).

VARIATIONS AVAILABLE

MODEL NO.	DESCRIPTION
18590-2092	12 Volt EMC 
18590-2094	24 Volt EMC 



Grinding Capabilities - capable of grinding waste down
to a particle size of 1/8" (3mm) max.

Capable of passing waste,
toilet tissue, facial tissue,
cigarettes, cigars, chunks of
soft fruit or vegetables less
than 1" size, fish scales, or
bait residue. Not designed to
pass fruit pips, rags, wet
strength kitchen towels,
tampons or sanitary napkins.

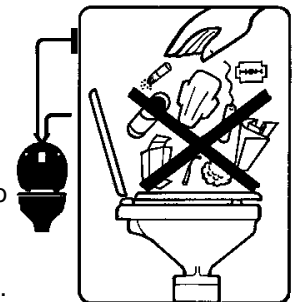

APPLICATIONS

WASTE EVACUATION

The Jabsco 18590 series DC macerator pump unit is the
ideal solution for emptying marine holding tanks when
not in a discharge restricted area. Self priming to 5ft this
pump will empty a typical 30 gallon (115 Liter) holding
tank in less than 3 minutes. Duty cycle of the pump is 15
minutes continuous which means a 180 gallon (680 liter)
can be emptied in a single operation

It is recommended that holding tanks be flushed with
several gallons of water after each pump out. This will
reduce the possibility of a continued build up of sediment
in the tank which could cause a potential blockage.

FISH BOX AND LIVELWELL TANK EVACUATION

The Jabsco Macerator Pump is the ideal pump for the
emptying of Fish box and livewell receptacles. Very
often the livewell tank will be above the waterline of the
boat, when this is the case gravity can be used to
empty the livewell tank. If not installed in this format
then it is beneficial to use the Jabsco macerator pump
for evacuation due to its self-priming capabilities and
also it's grinding properties.

Fish boxes are typically mounted into the floor of the vessel and are very often below the waterline or only partially above the waterline. Again the Jabsco Macerator pump has the characteristics that lend themselves to this application. The bait residue particles of ice, fish scales and anything else that could potentially be found in the Fish-Box will be easily passed by the Jabsco Macerator Pump, and the self priming capabilities are perfect for fish box installations common to many of today's sports fishing boats.

GENERAL INSTALLATION SUGGESTIONS

The pump can be mounted in any orientation without loss of performance. It is however recommended that if the pump is mounted vertically then the pump head be mounted below the motor (pump head facing downwards)

Use the rubber grommets provided to absorb vibration

The Macerator pump can be screwed directly into a 1-1/2" (38mm) NPT tank flange or female pipe fitting. If attaching the inlet port to a pipe fitting it may require removal of the hose barbed port, this can be done using a hacksaw. Wrap port threads with a couple of wraps of Teflon tape and screw the pump assembly into the pipe fitting. Tighten hand tight, do not over tighten.

Please Note: An air leak anywhere in the suction side of the plumbing system can cause extended dry running. All suction connections must be air tight and free of sharp bends or restrictions. If a deck fitting is installed for dockside pump-out and connected to the suction hose of the macerator by means of a tee fitting (without a Y-Valve), it too must be air tight to ensure proper priming.

Use minimum 1" (19mm) ID hose for discharge and connect to thru-hull fitting located approximately 4-6 inches above waterline.

NOTICE: The discharge thru-hull may be positioned below the waterline only if the discharge hose has a vented loop fitting installed at least 8" above the waterline at all angles of heel or trim. Consult with a qualified marine plumber.

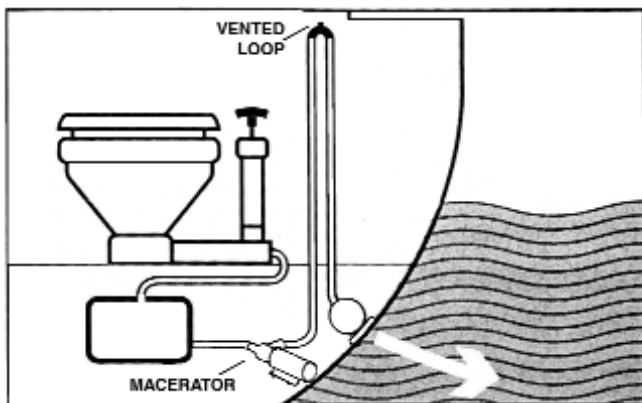

INSTALLATION FOR WASTE APPLICATIONS

Although the Jabsco Macerator pump can be installed at any convenient point in the waste discharge system, it is recommended that it be installed as close to the holding tank as possible, this will increase the performance of the pump. It is also recommended that the switch used to control the macerator be mounted close enough to the pump that it can be heard whilst in operation, this will allow the operator to hear a change in pump noise when the unit has finished pumping the tank dry. The pump then should be turned off; this will further increase the life of the pump.

INSTALLATION FOR FISH BOX AND LIVEWELL APPLICATIONS

As with the waste application the Jabsco Macerator Pump can be installed at any convenient point between the fishbox/livewell receptacle and the discharge port. It is recommended that it be installed as close to the tank as possible, this will increase the performance of the pump. It is also recommended that the switch used to control the macerator be mounted close enough to the pump that it can be heard whilst in operation, this will allow the operator to hear a change in pump noise when the unit has finished pumping the tank dry. The pump then should be turned off; this will further increase the life of the pump.

ELECTRICAL

Wire the unit in an Independent Circuit
Consult the wiring table for fuse and wire size
Consult the wiring diagram for connections

WIRING TABLE

VOLTAGE	AMP DRAW	FUSE SIZE	WIRE SIZE PER FEET OF RUN*				
			0'-10'	10'-15'	15'-25'	25'-40'	40'-60'
12 Vdc	16	20	#16(1.5)	#14(2.5)	#14(2.5)	#12(4)	#6(16)
24 Vdc	8	15	#18(1)	#16(1.5)	#16(1.5)	#14(2.5)	#10(6)

* Length of run is total length of the circuit from the power source to product and back to ground. Wire sizes listed are SAE gauge and metric millimeters.

Wiring Diagram

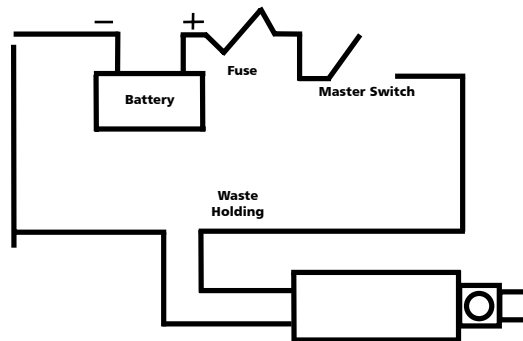

EXPLODED VIEW

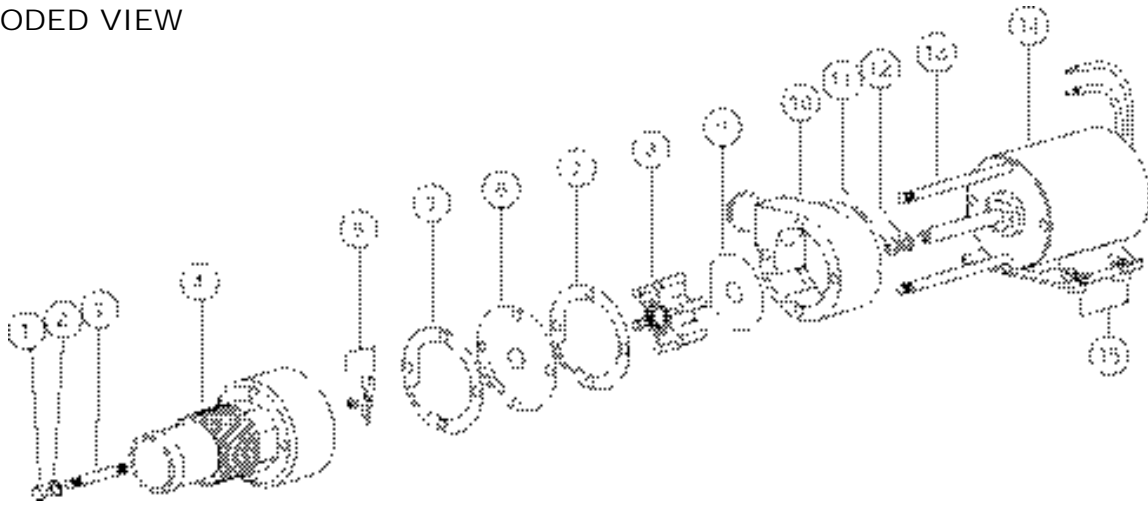

PARTS LIST

Key	Description	Qty.	Part Number
1	Acorn Nut	4	91085-0340
2	Fiber Washer*	4	91613-0140
3	Stud*	2	17288-0010
4	Macerator Housing	1	18594-1000
5	Chopper Plate with Locknut	1	37056-2000
6	Wearplate, Large	1	18597-1000
7	Gaskets (2 each per kit)*	1	18596-1000
8	Impeller*	1	6303-0003
9	Wearplate, Small	1	12316-1002
10	Body*	1	18593-1000
11	Seal*	1	1040-0000
12	Slinger	1	6342-0000
13	Stud	2	17288-0000
14	Motor 12 Volt	1	17246-1012
	Motor 24 Volt	1	17246-1024
15	Grommets (Set of 4)	1	92900-0120
	Service Kit	1	18598-1000

*These parts are supplied in 18598-1000 Service Kit.

DISASSEMBLY

Notice: Before performing any service, disconnect the electrical power to the macerator and take precaution to ensure that it is not restored until service is complete.

Remove the four acorn nuts (Key 1) and fiber washers (Key 2) from the pump studs (Key 3). Slide the macerator housing (Key 4) off the studs. Insert a thin bladed 9/32" (7mm) ignition wrench behind the chopper plate (Key 5) and onto the flat of the motor shaft to prevent it from turning. Unscrew (counter-clockwise) the locknut on the end of the motor shaft and remove the stainless steel chopper blade.^{††} On new model macerators the shaft can be prevented from turning by inserting a screwdriver in the slot of the motor shaft extending from the motor's rear end bell. Remove the pump wearplate (Key 6) and two paper gaskets (Key 7). Now slide the pump body (Key 10) with impeller (Key 8), small wearplate (Key 9), two studs and shaft seal as an assembly off the motor shaft and remaining two mounting studs.

Remove the starlock retaining washer on the seal and push the seal out of the seal bore.

Notice: If reconditioning pump with a service kit (Part No. 18598-1000), it is not necessary to remove the seal because the new seal is pre-installed in the new body. It is also generally not necessary to remove the slinger or brass studs screwed into the motor end bell.

ASSEMBLY

If installing a new seal, push it into the seal bore of the body with the lip pointing toward the impeller bore. Press the starlock washer into the seal bore with the concave side up to secure the seal in the bore. Install the two shorter studs in the two holes with threaded inserts in the new pump body and tighten finger tight. If required, screw two longer studs into the tapped holes in the motor end bell. Slide the new pump body with the shaft seal installed onto the motor shaft and two long mounting studs in the motor. Slide the small wearplate over the motor shaft and position it in the bottom of the impeller bore. Slide the new impeller onto the motor shaft and, with a counter-clockwise motion, push it into the pump impeller bore. Position one new gasket on the studs and against the pump body assuring the cut-out aligns with the inlet groove in the body. Reposition the large wearplate and second gasket on the studs and against the body; again, aligning the hole in the wearplate and gasket cut-out with the pump inlet. Position the chopper on the end of the motor shaft with drive tab aligned with flat of shaft and pointing toward the motor. Hold the shaft to prevent it from turning and secure the chopper to the shaft with the locknut. Position the macerator housing on the four studs ensuring the cut-out in the inner wall aligns with pump body inlet port and hole in the wearplate. Position a new fiber washer on each of the studs and secure the macerator housing in place with the four acorn nuts.

^{††} On pumps manufactured prior to April of 1998, position a screwdriver between the prongs of the chopper and unscrew it (counter-clockwise) to remove it and its lock washer from the motor shaft.

DIMENSIONAL DRAWING
Inches (Millimeters)

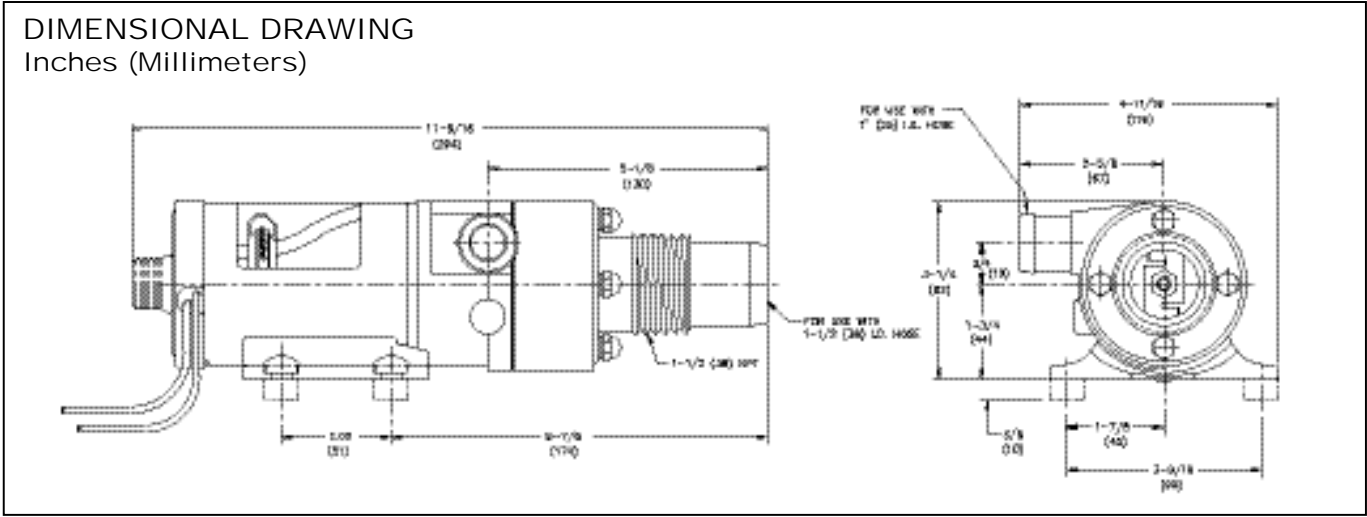

TROUBLESHOOTING

PUMP DOES NOT START:

Impeller bound-up - Insert screwdriver in slot of shaft at motor's rear end bell and rotate clockwise.

No electrical power to pump or low voltage - With a voltage tester, check power to pump. The pump must have full voltage *checked while pump is running*. If it hasn't started, see wire size recommendations and check for poor or corroded electrical connections.

PUMP RUNS BUT DOES NOT PUMP:

Lack of priming - Check all plumbing connections to ensure they are *airtight*. If a waste deck plate is connected to pump suction hose by a "Tee" fitting, the deck plate must also be *airtight*.

Worn impeller* - Replace flexible impeller.

*A worn impeller may be a likely cause if the Run-Dry Protection Device has often been allowed to shut-off the pump.

After long periods of nonuse, the flexible impeller may stick to the pump body preventing the macerator pump from turning freely. If this occurs, the impeller can be broken free by removing the rubber cap on the shaft at the rear end of the motor, inserting a screwdriver in the slot and rotating the shaft clockwise a quarter turn or more. When impeller is broken free, reinstall the plastic cap on the motor shaft.

MOTOR ILLUSTRATION

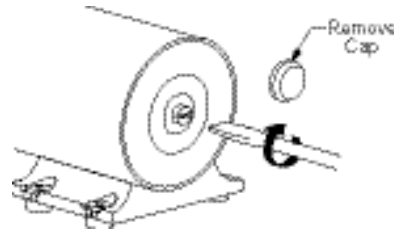

Jabsco



THE PRODUCTS DESCRIBED HEREIN ARE SUBJECT TO THE JABSCO ONE YEAR LIMITED WARRANTY, WHICH IS AVAILABLE FOR YOUR INSPECTION UPON REQUEST.

U.S.A.
Jabsco
Cape Ann Industrial Park
Gloucester, MA 01930
Tel: 978.281.0440
Fax: 978.283.2619

UNITED KINGDOM
Jabsco
Bingley Road, Hoddesdon
Hertfordshire EN11 OBU
Tel: +44 (0) 1992 450145
Fax: +44 (0) 1992 467132

CANADA
Fluid Products Canada
55 Royal Road
Guelph, Ontario N1H 1T1
Tel: (519) 821.1900
Fax: (519) 821.2569

JAPAN
NHK Jabsco Company Ltd.
3-21-10, Shin-Yokohama
Kohoku-Ku, Yokohama, 222
Tel: 045.475.8906
Fax: 045.475.8908

GERMANY
Jabsco GmbH
Oststrasse 28
22840 Norderstedt
Tel: +49-40-53 53 73 -0
Fax: +49-40-53 53 73 -11