



Series 9200, 9500 and 1536 through 1551 Direct and Gas Engine-Driven Centrifugal Pumps

HYPRO®

Form L-0300AG
Rev. B

Installation, Operation, Repair Instructions

Description

Hypro Centrifugal Pumps handle big, high-capacity farm spraying jobs with ease. Use them for spraying liquid fertilizers and other chemicals, including wetttable powder slurries for weed control. Make short work of

other farm jobs - filling nurse tanks, watering seed beds, and transferring liquids.

Available in a variety of models, including lightweight polypropylene (pump portion only) pumps for resistance to corrosive liquids such as acid-based fertilizers.

California Proposition 65 Warning -- This product and related accessories contain chemicals known to the State of California to cause cancer, birth defects or other reproductive harm.

This form replaces Form L-0300C. For individual parts breakdowns, product outlines and performance specifications, visit www.hypropumps.com. See chart below for new form numbers.

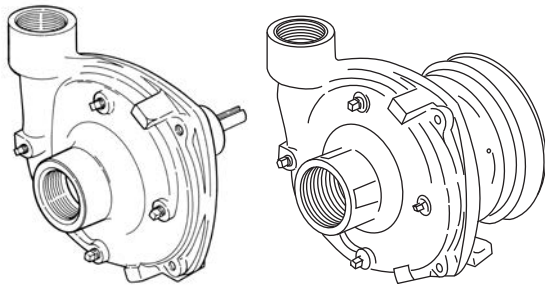

SERIES 9200
Cast Iron, Stainless Steel
Pedestal-Mount Centrifugal Pumps

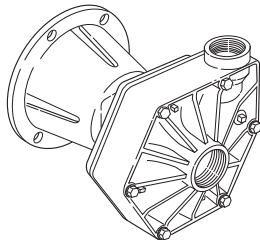

SERIES 9500P
Polypropylene
Flange-Mount Centrifugal Pumps

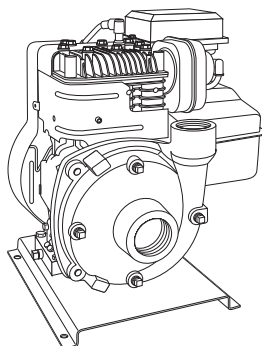

SERIES 1500
Close-Coupled, Gas Engine-Driven
Centrifugal Pumps

| Pump/Model Number | New Form Number |
|--|-----------------|
| 9202C, 9202S, 9262C-C and 9262S-C | L-0300AG-1 |
| 9203C, 9203C-R, 9203S, 9203S-R, 9263C-C and 9263S-C | L-0300AG-2 |
| 9203C-SP, 9203S-SP, 9263C-C-SP, 9263S-C-SP..... | L-0300AG-3 |
| 9203C-R-SP and 9263C-CR-SP | L-0300AG-4 |
| 9203P-S and 9253P-C..... | L-0300AG-5 |
| 9204C..... | L-0300AG-6 |
| 9205C..... | L-0300AG-7 |
| 9205C-SP and 9205C-BSP | L-0300AG-8 |
| 9206C and 9206S | L-0300AG-9 |
| 9513P..... | L-0300AG-10 |
| 1521, 1536, 1537, 1538, 1539 and 1540..... | L-0300AG-11 |
| 1522C-65SP, 1536-SP, 1537-SP, 1538-SP, 1539-SP and 1540-SP..... | L-0300AG-12 |
| 1550, 1551 and 1552 Series... | L-0300AG-13 |



Safety Information

- 1. WARNING: Do Not Pump Flammable or Explosive Fluids Such as Gasoline, Fuel Oil, Kerosene, etc. Do Not Use in Explosive Atmospheres. Components not rated for use with Anhydrous Ammonia. The Pump Should be Used Only with Liquids that are Compatible with the Pump Component Materials. Failure to Follow this Warning May Result in Personal Injury and/or Property Damage and Will Void the Product Warranty.**
2. Be sure all exposed moving parts, such as PTO shafts and adapters, are properly shielded or guarded and that all coupling devices are securely attached before applying power.
3. Pumps mounted directly onto PTO shaft or other power shaft must be prevented from rotating with the power shaft. Pump must float freely on the power shaft and must not be tied rigidly to equipment on which it is mounted.
4. DO NOT EXCEED recommended speed, pressure and temperature (140° F) for pump and equipment being used.
5. BEFORE SERVICING, disconnect all power, make sure all pressure in the system is relieved, drain all liquids from the system and flush. On gas engine-driven models, remove the spark plug wire from the spark plug before servicing the pump or engine.
6. Secure the discharge lines before starting the pump. An unsecured line may whip, causing personal injury and/or property damage.
7. Check hose for weak or worn condition before each use. Make certain that all connections are tight and secure.
8. Periodically inspect the pump and the system components. Perform routine maintenance as required (see Maintenance section).
9. Protect pump from freezing conditions by draining liquid and pumping rust-inhibiting antifreeze solution through the system, coating the pump interior.
10. Do not operate a gasoline engine in an enclosed area. Be sure the area is well ventilated.

WARNING: Gasoline is a Highly Combustible Fuel. The Improper Use, Handling, or Storage of Gasoline Can be Dangerous. Never Touch or Fill a Hot Engine.

11. Use only pipe, hose and fittings rated for the maximum psi rating of the pump.
12. Do not use these pumps for pumping water or other liquids for human or animal consumption.

WARNING: Pump must not be run dry.



Hazardous Substance Alert

1. Always drain and flush pump before servicing or disassembling for any reason (see instructions).
2. Always drain and flush pumps prior to returning unit for repair.
3. Never store pumps containing hazardous chemicals.
4. Before returning pump for service/repair, drain out all liquids and flush unit with neutralizing liquid. Then, drain the pump. Attach tag or include written notice certifying that this has been done. Please note that it is illegal to ship or transport any hazardous chemicals without United States Environmental Protection Agency Licensing.

Drive Source Installation

This manual will cover the installation of the basic drive configurations available for Hypro direct-drive centrifugal pumps. Consult the manufacturer of your tractor, motor or engine for additional information. Read all instructions and general safety information before attempting to install or operate the pump.

Belt/Pulley Drive Installation

Series 9200 Pedestal-Mounted Centrifugal Pumps

Mounting Belts and Pulleys

Mount pulleys as close to pump and motor engine shaft bearings as possible. Check alignment with a straight edge as shown in Fig. 1. Make sure that belt has proper tension. (Too much tension will cause bearing wear; too little will cause slippage.) See Fig. 2. Check with belt and pulley sources for specific recommendation.

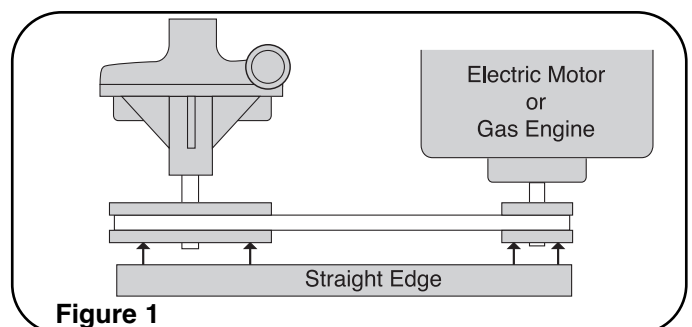

Belt/Pulley Drive Installation (cont'd.)

To figure proper diameter of pump pulley, multiply motor/engine rpm by diameter of the motor/engine pulley and divide that figure by desired pump speed.

$$\text{Pump Pulley Size} = \frac{\text{Motor RPM} \times \text{Motor Pulley Size}}{\text{Desired Pump Speed}}$$

Refer to pump performance charts to determine desired speed to obtain desired maximum flow.

IMPORTANT: Note that shaft rotation is counter-clockwise as viewed from the shaft - opposite from most standard centrifugals. Be sure to drive pump in proper direction.

Push the belt midway between the pulleys, check the deflection (d) and adjust:

$$d = 0.016 \times L$$

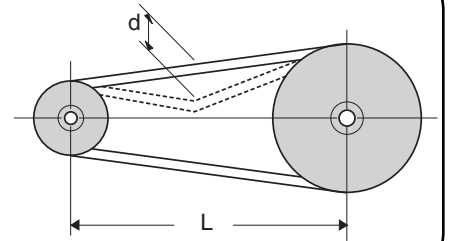

Figure 2

Direct Drive - Flexible Coupling Installation

Series 9200 and 9500P Pedestal-Mounted Centrifugal Pumps

To install couplings, slide coupling ends onto motor or engine and pump shafts as far as possible. Mount engine/motor and pump on base. Shim up pump or power to align shafts. Leave enough room between shaft ends to install center disc. When aligned, slide ends over disc. Select couplings rated twice required horsepower when using motor; three times when using gas engine.

NOTE: Direction of shaft rotation, as viewed from the shaft side, is counterclockwise for Series 9200 and clockwise for 9500P. 9200P is shown.

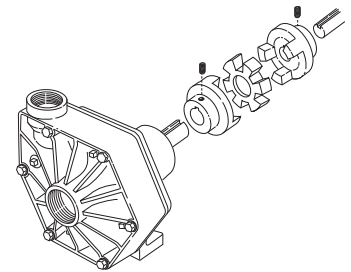

Figure 3

Direct Drive Gas Engine Installation for Models 1538 and 1551

Refer to your pump parts breakdown.

- Lubricate the seal cavity in the flange with WD-40, LPS or equivalent.
Be extremely careful with the new seal. Take special care not to scratch the lapped sealing faces of the rotary seal and stationary seat.
- Install the stationary portion of the mechanical seal by pushing it into the bore of the flange with the ceramic side out.
Important: Make sure the seal "cavity" is clean and lubricated. Never run the sealing faces dry.
- To seat the seal in the seal cavity, use a piece of 3/4" PVC pipe (1" for 1551) 4" to 6" in length. Press seal in firmly and squarely.
- Install slinger ring onto gas engine shaft.
- Install flange onto the gas engine. Make sure the flange bore fits into the bore on the engine. See Fig. 4.
- Insert four bolts and four seals (four bolts only for 1551) through the flange and into the gas engine. Tighten to 80-100 inch pounds of torque.
- To install the rotary portion of the mechanical seal, place it over the shaft with the carbon side facing in, and press until it bottoms out against the stationary seal portion.

Important: Use care in installing the seal on the shaft. The seal can be damaged by threads on the engine shaft.

- Install the gasket over the shaft against the rotary portion of the seal.
- Install the impeller onto the shaft, and hand tighten until it is secure.
- Install the o-ring on the mounting flange.
- Place the pump casing on the mounting flange; insert the bolts and tighten evenly.

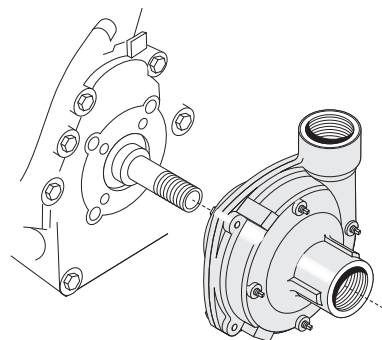

Figure 4

Direct Drive - Flange Mount Installation

GAS ENGINE MOUNT — Model 9513P fits most 5 hp gas engines with flange mount and 3/4" shaft.

To install pump onto gas engine, first apply anti-seize compound to gas engine shaft and to inside of pump hollow shaft. Insert key into engine shaft. Next, slide pump onto engine shaft and secure with four hex head bolts. NOTE: Do not force pump onto shaft. Tighten set screws on pump shaft through slots in flange. Check to make sure pump rotates freely by slowly turning over the gas engine.

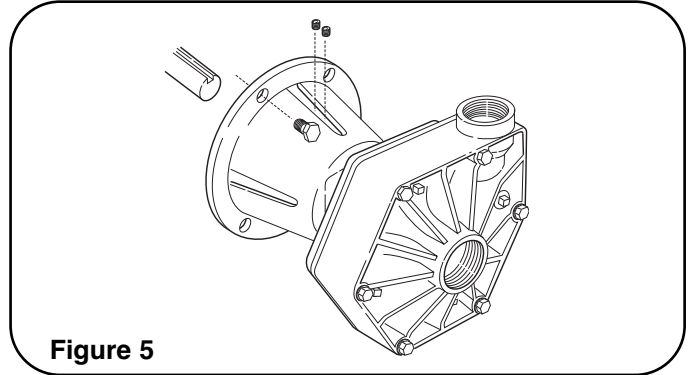

Figure 5

Operation and Maintenance

IMPORTANT: ENGAGE PTO CLUTCH SLOWLY AND SMOOTHLY. AVOID SUDDEN STARTS AND FAST CLUTCHING THAT CAN DAMAGE THE DRIVE SECTION OF THE PUMPS.

Controlling the Flow

Two flow control valves are used - one in the agitation line and one in the line leading to the boom or spray gun. This permits controlling agitation flow independently of nozzle flow.

To Adjust For Spraying

To adjust sprayer (regardless of power source - PTO, belt or pulley), follow these steps:

1. Prime pump with all valves open.
2. Close control valve and agitation line valve; open boom shut-off valve.
3. With pump running, open the control valve until pressure gauge indicates desired spraying pressure.
4. Open the agitation line valve until sufficient agitation is observed. Then, if spraying pressure drops, readjust the control valve to restore desired pressure.
5. Make sure flow is uniform from all nozzles.

After spraying adjustments are made, it is only necessary to close boom shut-off valve to discontinue spraying. On belt-drive models, check belt tension daily or before each use.

Flush Pump After Use

One of the most common causes for faulty pump performance is "gumming" or corrosion inside the pump. Flush the pump and entire system with a solution that will chemically neutralize the liquid pumped. Mix according to manufacturer's directions. This will dissolve most residue remaining in the pump, leaving the inside of the pump clean for the next use.

To Prevent Corrosion

After cleaning the pump as directed above, flush it with a permanent-type automobile antifreeze (Prestone, Zerex, etc.) containing a rust inhibitor. Use a 50% solution - that is, half antifreeze and half water. Plug the ports to keep out air during storage. For short periods of idleness, non-corrosive liquids may be left in the pump, BUT AIR MUST BE KEPT OUT. Plug ports or seal port connections.

Troubleshooting

| System | Probable Cause(s) | Corrective Action(s) |
|------------------------------|---|--|
| Low Discharge | Pump not primed. | Remove topmost vent plug from face of pump and run pump to expel trapped air (See Installation Instructions). Recommend vent line be used (KIT#3430-0456). |
| | Air leaks in suction line. | Check and reseal inlet fittings. |
| | Blocked or clogged line strainer or impeller. | Inspect strainer and impeller to clear any debris or obstruction. |
| | Undersize suction line or collapsed hose. | Suction line should be the same diameter as inlet port of pump or larger. |
| Liquid leaking out weep port | Eye of impeller rubbing on volute. | Remove volute (front cover) and inspect the impeller. If wear detected, sand the impeller eye O.D. with emery cloth. |
| | Worn seal. | Replace seal. |

Repair Instructions

Recommended repair tools for use with these instructions:

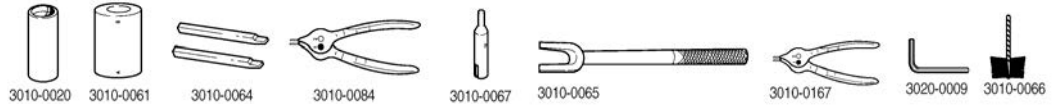

Always flush pump with water, or neutralizing agent, before servicing.

Pump Housing Disassembly (All Models)

In most cases, seal replacement requires disassembly of only the pump half of the unit.

NOTE: Instructions following in italics describe procedures for the polypropylene centrifugal pumps when different than the cast iron pumps.

1. Remove the four casing cap screws with 9/16" box end wrench. Tap pump casing on discharge port with rubber hammer, if necessary, to break loose from mounting flange. Check inside of pump casing including suction port.

If badly eroded [or damaged], pump casing should be replaced. Remove o-ring and discard. O-ring should always be replaced. [Using a 1/2" wrench, remove the six bolts from the front. Also remove the 5/16" screw from the rear near the outlet port.]

2. To remove the impeller nut, clamp the flange in a vise and insert a large screwdriver or file (at least 10" long) into impeller vanes to prevent impeller from turning when loosening nut. Use a socket wrench (3/4" for Series 9000C or 5/8" for Series 9200C and 9400C) to remove the impeller nut by turning it counterclockwise (Fig. A). [Use 7/8" deep socket wrench to remove plastic seal nut, then 9/16" deep socket to remove metal jam nut, rubber gasket and washer.]
3. Once the nut [and washer] is removed, place a screwdriver on each side (Fig. B) behind the impeller and pry away from the mounting flange. Remove woodruff key from the shaft (for Series 9000 only). Remove o-ring from the mounting flange. **NOTE:** Fig. B shows 9000C gear flange. The same general procedure applies for the other pumps.

Pump Seal Removal

1. Lightly lubricate shaft for easier removal of seal. Using two screwdrivers positioned opposite each other, pry the rotary portion of the seal from the shaft (Fig. C).
2. [Remove plastic back cover flange. Knock seal out from back with a hammer and screwdriver.]
3. Remove stationary seat and boot by prying out with two small screwdrivers in manner similar to impeller removal. (Caution: The seal will be damaged by removal in this manner. A new seal and rubber gasket **MUST** be used when pump is reassembled.)

Cleanup Of Pump Housing

1. Using the circular bottle-type wire brush with air or hand drill, clean the discharge port, suction port and the sealing areas of the o-ring on the pump casing and mounting flange. [The last step should not be performed on the polypropylene models.]
2. After wire brush cleaning, it is recommended that the pump casing and mounting flange be further cleaned in a solvent tank to remove rust and corrosion particles.

Pump Shaft and Bearing Assembly Removal and Replacement

1. While the pump is disassembled (see the Pump Housing Disassembly section), the driven pulley on the pump shaft must be removed. Remove the large retainer ring in pump bearing bore on the pulley side of housing. Press out the shaft and bearing assembly from the pump side using an arbor press.
2. Bearings must be pressed off each end of shaft and replaced in the same manner. **NOTE:** Shaft diameter between bearings is larger.
3. For reassembly, reverse the order of instructions.

Seal Replacement/Pump Housing Reassembly

NOTE: Reassemble if drive end is not to be repaired.

Be extremely careful with the new seal. Take special care not to scratch the lapped sealing faces of the rotary washer and stationary seat.

1. Lubricate seal cavity in mounting flange with WD-40, LPS or equivalent.
2. Install the stationary portion of the mechanical seal by sliding over the shaft with the ceramic side out.

IMPORTANT: Make sure the seal cavity is clean and lubricated. Never run the sealing faces dry.

3. To seat the seal in the seal cavity, use a piece of 3/4" PVC pipe 4" to 6" in length. Press it in firmly and squarely.
4. To install the rotary portion of the mechanical seal, place it over the shaft with the carbon side facing in, and press until it bottoms out against the stationary portion (Fig. D).
5. Insert key into shaft key slot. Place impeller on shaft. Put [washer, jam nut and gasket] impeller nut on shaft end, and using a large screwdriver or file in the impeller vanes for support, tighten impeller nut securely.
6. Install o-ring on mounting flange. Replace o-ring if worn or damaged.
7. Place pump casing on mounting flange, insert and tighten bolts evenly.

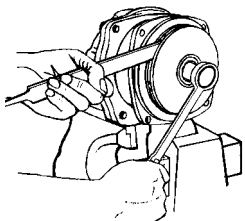

Figure A

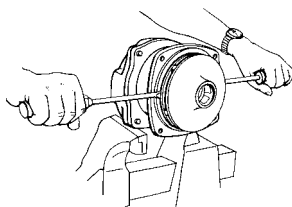

Figure B

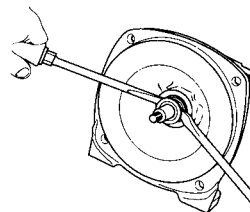

Figure C

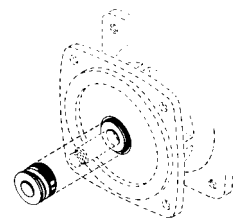
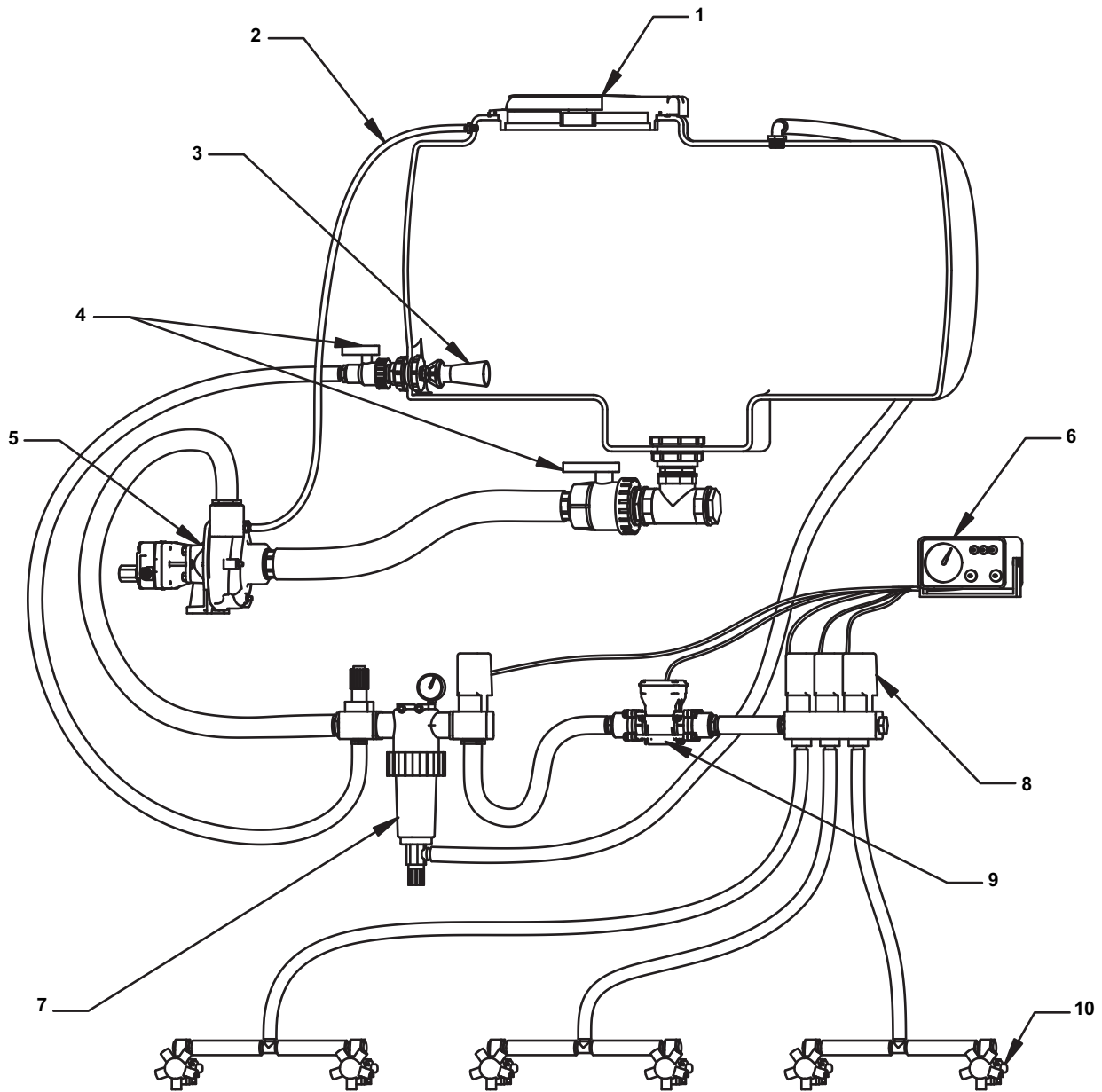

Figure D

Plumbing Installation



Centrifugal Plumbing Hook-up

| REF. NO. | DESCRIPTION |
|----------|--------------------------------|
| 1 | Tank Lid |
| 2 | Vent Line #3430-0456 |
| 3 | Jet Agitator |
| 4 | Shut-off Ball Valves |
| 5 | Centrifugal Pump |
| 6 | Spray Control Console |
| 7 | Centrifugal Pump Control |
| 8 | Manifold Boom Valve |
| 9 | Electromagnetic Flowmeter |
| 10 | Compact Jet Turret Nozzle Body |

Plumbing Installation

Pump Installation:

The following are recommendations to achieve the optimal performance out of your centrifugal pump and your spraying system.

Pump Inlet Line

To achieve full capacity from the pump, the inlet line should be at least the same size as the inlet port on the pump. Reducing this line size will restrict the capabilities of the pump. The line must also be free of air leaks. Check all fittings and connections in the suction line for tightness. The introduction of air may affect the priming and pumping capabilities of the pump. Use good quality suction hose that will not be collapsed by suction.

For non Self-Priming models, the centrifugal pump should be mounted below the liquid level and as near to the liquid source as possible to allow for the shortest suction line practical. To achieve optimal performance, the suction line should slope down into the pump. Avoid rises and humps that could trap air in the line to the pump. The suction line and pump should be filled with liquid prior to starting the pump and all discharge lines should be open.

Priming:

IMPORTANT: PUMP MUST NOT BE RUN DRY.

In addition to the proper suction plumbing, a vent line should be installed to assist in priming. Use a Hypro Vent Line Kit 3430-0456. The vent line will help to prevent air locks and allows air to bleed off to the tank. This helps ensure proper priming and helps to prevent dry-run damage to the mechanical seal during priming. The vent line should be installed in the top port of the pump casing and the line routed sloping upward to the tank, where it should be mounted above the liquid line.

Pump Outlet Line

The recommended orientation for the outlet port is pointing straight up. This allows liquid to stay in the pump while it is priming. The outlet line should be the same size as the pressure port on the pump to give the optimal flow. The line should have as few restrictions and elbows as possible to optimize the pump performance and reduce pressure drop from the pump to the spray tips.

Centrifugal Pump Control

Hypro now offers many different components for spraying systems. The Hypro centrifugal pump control incorporates the electric flow control valve, a self-cleaning line strainer, a visual pressure gauge and a manual agitation control valve.

Flow Control Valve

A high-flow electric proportional valve allows for maximum flow control to the boom valves. It provides smooth, rapid control that can be controlled from either an electronic rate controller or switch box.

Strainers

The recommended placement of the strainer for a centrifugal pump is in the pump outlet line. This will eliminate any possible restriction that the strainer could create if it were installed in the inlet line. Ensure that the proper strainer size and screen mesh are used to limit the pressure drop and achieve the best filtration. Line strainers can also be installed in the tank fill line to filter liquid as it is loaded into the tank as well as in the boom lines to further filter the solution prior to the spray tips. Tank baskets can also be used to filter material added through the tank lid.

Agitation

The centrifugal pump control contains a manual agitation control valve that can be adjusted to provide the right amount of flow to the jet agitators in the tank to ensure proper mixing within the tank.

Flowmeter

To eliminate the mechanical problems of a turbine flowmeter, we recommend that an electromagnetic flowmeter be used. These flowmeters have no moving parts to wear out and will provide a more consistent and accurate flow reading. They can be input into just about any electronic rate controller or switch box.

Boom Section Valves

For rapid response and reliability, we recommend electric plunger valves be used for boom control. The valves should be sized accordingly to minimize the pressure drop and maximize the flow rate. The boom tubing or hose should be sized accordingly to ensure that a pressure drop in the lines does not occur, causing inconsistent pressures at the nozzles.

Nozzle Bodies

Nozzle bodies with shut-off check valves are recommended to eliminate dripping from the spray tips when the boom valves are shut down.

**For further information
regarding Hypro products,
contact your local dealer
or Hypro directly at
www.hypropumps.com or by
calling 1-800-424-9776.**

Limited Warranty on Hypro/SHURflo Agricultural Pumps & Accessories

Hypro/SHURflo (hereafter, "Hypro") agricultural products are warranted to be free of defects in material and workmanship under normal use for the time periods listed below, with proof of purchase.

- Pumps: one (1) year from the date of manufacture, or one (1) year of use. This limited warranty will not exceed two (2) years, in any event.
- Accessories: ninety (90) days of use.

This limited warranty will not apply to products that were improperly installed, misapplied, damaged, altered, or incompatible with fluids or components not manufactured by Hypro. All warranty considerations are governed by Hypro's written return policy.

Hypro's obligation under this limited warranty policy is limited to the repair or replacement of the product. All returns will be tested per Hypro's factory criteria. Products found not defective (under the terms of this limited warranty) are subject to charges paid by the returnee for the testing and packaging of "tested good" non-warranty returns.

No credit or labor allowances will be given for products returned as defective. Warranty replacement will be shipped on a freight allowed basis. Hypro reserves the right to choose the method of transportation.

This limited warranty is in lieu of all other warranties, expressed or implied, and no other person is authorized to give any other warranty or assume obligation or liability on Hypro's behalf. Hypro shall not be liable for any labor, damage or other expense, nor shall Hypro be liable for any indirect, incidental or consequential damages of any kind incurred by the reason of the use or sale of any defective product. This limited warranty covers agricultural products distributed within the United States of America. Other world market areas should consult with the actual distributor for any deviation from this document.

Return Procedures

All products must be flushed of any chemical (ref. OSHA section 1910.1200 (d) (e) (f) (g) (h)) and hazardous chemicals must be labeled/tagged before being shipped* to Hypro for service or warranty consideration. Hypro reserves the right to request a Material Safety Data Sheet from the returnee for any pump/product it deems necessary. Hypro reserves the right to "disposition as scrap" products returned which contain unknown fluids. Hypro reserves the right to charge the returnee for any and all costs incurred for chemical testing, and proper disposal of components containing unknown fluids. Hypro requests this in order to protect the environment and personnel from the hazards of handling unknown fluids.

Be prepared to give Hypro full details of the problem, including the model number, date of purchase, and from whom you purchased your product. Hypro may request additional information, and may require a sketch to illustrate the problem.

Contact Hypro Service Department at 800-468-3428 to receive a Return Merchandise Authorization number (RMA#). Returns are to be shipped with the RMA number clearly marked on the outside of the package. Hypro shall not be liable for freight damage incurred during shipping. Please package all returns carefully. All products returned for warranty work should be sent **shipping charges prepaid** to:

HYPRO / PENTAIR
Attention: Service Department
375 Fifth Avenue NW
New Brighton, MN 55112

For technical or application assistance, call the **Hypro Technical/Application number: 800-445-8360**, or send an email to: **technical@hypropumps.com**. To obtain service or warranty assistance, call the **Hypro Service and Warranty number: 800-468-3428**; or send a fax to the **Hypro Service and Warranty FAX: 651-766-6618**.

*Carriers, including U.S.P.S., airlines, UPS, ground freight, etc., require specific identification of any hazardous material being shipped. Failure to do so may result in a substantial fine and/or prison term. Check with your shipping company for specific instructions.

Note: This warranty does not apply to Hypro Pump Kit Model 1538, 1551, 1538-SP and 1551-SP. This is because the user could incorrectly assemble the parts and cause the pump to work improperly.



375 Fifth Avenue NW • New Brighton, MN 55112
Phone: (651) 766-6300 • 800-424-9776 • Fax: 800-323-6496
www.hypropumps.com