



GRISWOLD™

A **DOVER** COMPANY

811

ANSI CENTRIFUGAL
PUMPS FOR THE
PROCESSING
INDUSTRY

PERFORMANCE

D A R E T O C O M P A R E

GRISWOLD 811

MOVE YOUR

GRISWOLD: ANYTHING BUT STANDARD

The Griswold Pump Company is no newcomer to pumps. With product lines dating back over 70 years, you'll find a wealth of industry knowledge and experience behind every Griswold product. At our facility in Grand Terrace, California, we manufacture a variety of pumps, including ANSI, end suction centrifugals, self-priming and submersible/vertical turbines. With hundreds of thousands of pump installations worldwide and our international distribution network, Griswold serves a broad range of chemical process, industrial and municipal applications, including:

Pulp and paper
Chemical
Petrochemical
Oil and gas
Textile
Breweries
Grain processing
Food processing
Poultry processing
Automotive
Pharmaceutical
Steel
Semiconductor
Water treatment
Power generation

ARE ALL ANSI PUMPS THE SAME?

In 1977, the American National Standards Institute (ANSI) established manufacturing criteria for centrifugal pumps to ensure that dimensional, material composition and safety specifications meet the demanding needs of the chemical processing industry. Mandatory design features, such as self-ventilation, foot mounting, center-line discharge and back pullout, became the industry's assurance that complying pumps met production and safety needs.

Even though ANSI compliance would seem to level the playing field for pump specification, your choices are actually far more complex. The fact is that many brands just meet the minimal requirements of this standard. And while other brands may offer similar features and performance, you may experience inflated cost, delayed delivery, and deflated service. In a market where all ANSI pumps seem the same, **dare to compare**.

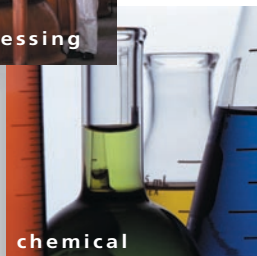
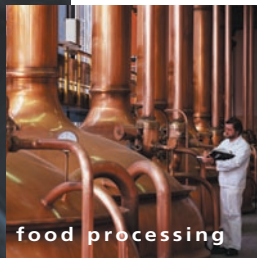

WHAT DRIVES YOUR PUMP SELECTION PROCESS?

In a rapidly changing world market, there's no longer room for making business decisions based on convention or costly old relationships. Every angle must be scrutinized to give your production process the edge needed to survive economic volatility and polarized competition.

Maximizing production and minimizing costs are as much functions of equipment performance as initial and long-term costs of operating and maintaining equipment. Most importantly, you must minimize the time and financial losses caused by production failures. As a result, pump specification must meet even more demanding criteria than ANSI compliance:

- 1 Proven track record of performance**
- 2 Extended equipment life**
- 3 Reduced initial cost and total cost of ownership**
- 4 Speed and ease of repair or replacement**

Dare to compare your ANSI pump. In a world where you need every advantage—we're confident you'll choose Griswold.



ANSI PUMPS

PROCESS TO A HIGHER STANDARD



1

PROVEN TRACK RECORD OF PERFORMANCE:

COMPARE

page 4-7

811

other brands

The Griswold 811 ANSI line offers the best pumps you'll find on the market. Engineered for exceptional performance and maximum flexibility, our 811 models go the mile in the harshest and most difficult fluid processing applications. Griswold's 811 centrifugal pump not only meets ANSI standards for chemical processing, it was among the first pump designs to comply with these standards in the 1970s. Almost 30 years of proven performance has enabled Griswold to focus on enhancing our ANSI pump features and support offerings to surpass the industry standard and exceed our customers' expectations.



2

EXTENDED EQUIPMENT LIFE:

COMPARE

page 8-11

811

other brands

Exceeding standard ANSI construction requirements, the Model 811 includes several additions that are critical to long-term reliable function. To start, our superior open impeller and seal chambers are designed to facilitate corrosive and erosive substance transport, heat regulation and routine maintenance. The 811's range of enhanced power frames and rigid base plates combine the latest technology with the highest quality construction to minimize the effects of work forces and shaft deflection, optimize cooling and further simplify the installation and maintenance process. All told, you can expect the 811 pump series to continue performing long after other ANSIs wear out or break down.

3

REDUCED INITIAL & TOTAL COST OF OWNERSHIP:

COMPARE

page 4-13

811

other brands

You may have heard that the initial cost of your pump and parts plays a minor role in your total cost of ownership. NOT TRUE! With Griswold's 811, you get identical quality and longevity as the best-known brands—at a lower initial price. Factor in our low cost on parts, and your long-term savings are even greater! This translates into your LOWEST total cost of ownership.

4

SPEED AND EASE OF REPLACEMENT:

COMPARE

page 4-13

811

other brands

When meeting your production quota is compromised, each day waiting for repairs can mean significant losses in revenue (another factor in your *true* cost of ownership). The Griswold 811 and our extensive inventory of parts are **100% interchangeable with hundreds of thousands of other ANSI pumps currently in use**. With stocking distributors from coast-to-coast and throughout the world, backed by Griswold's 36-hour ship commitment (next day on parts), and NO premium charge for expedited shipment, you can be up and going before you may even get a response call from our competition!

And with our dedication to customer service, reduced response times and engineering support, Griswold stands ready to help improve your process, increase your productivity, lower your costs and reduce your stress.

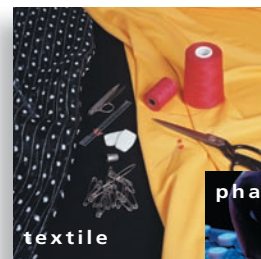

GRISWOLD 811 M

FEATURE FOR FEATURE CHALLENGE

ENGINEERED FOR FLEXIBILITY & DURABILITY

The Model 811 is available in a wide range of sizes, capacities and materials to fit virtually any process fluid application. With over 30 selections and multiple design options, we've got your application covered—for abrasive and corrosive substances, and capacities ranging from 4 through 4000 gallons per minute.

Griswold maintains strict quality assurance programs to ensure that our entire product line is manufactured to the highest standard for engineered tolerances:

- Our American-engineered investment and no-bake casting processes produce smooth, superior surface finishes for consistent and reliable performance.
- A metallurgist-controlled annealing process assures the maximum durability and product life available on the market.
- CNC (computer numerically controlled) machining equipment guarantees consistency for all parts.
- All power frames are assembled and inventoried in our Clean Room to keep sensitive bearings and internal components contaminant-free.

LABYRINTH SEALS STANDARD:

INPRO® oil seals keep outside contaminants from lubrication media, significantly extending bearing life. Standard in bronze. Carbon-filled Teflon® and magnetic face seals optional.

MOUNTING FRAME FLANGE:

Machined to accommodate C-face motor adapters.

EXTRA LARGE CAPACITY POWDER-COATED OIL SUMP:

Maximized oil capacity delivers improved heat transfer and oil temperature, greatly extending bearing life. Designed to accommodate optional fin coolers for higher temperature applications. Impenetrable fusion bonded epoxy coating on interior surface extends quality, cleanliness and longevity of the lubricating oil.

DUCTILE IRON FRAME ADAPTERS:

Ductile Iron construction provides strength and safety. Precision-machined fits accurately align the liquid end to the power end. Large openings simplify installation and maintenance. Includes jacking bolts to facilitate disassembly.

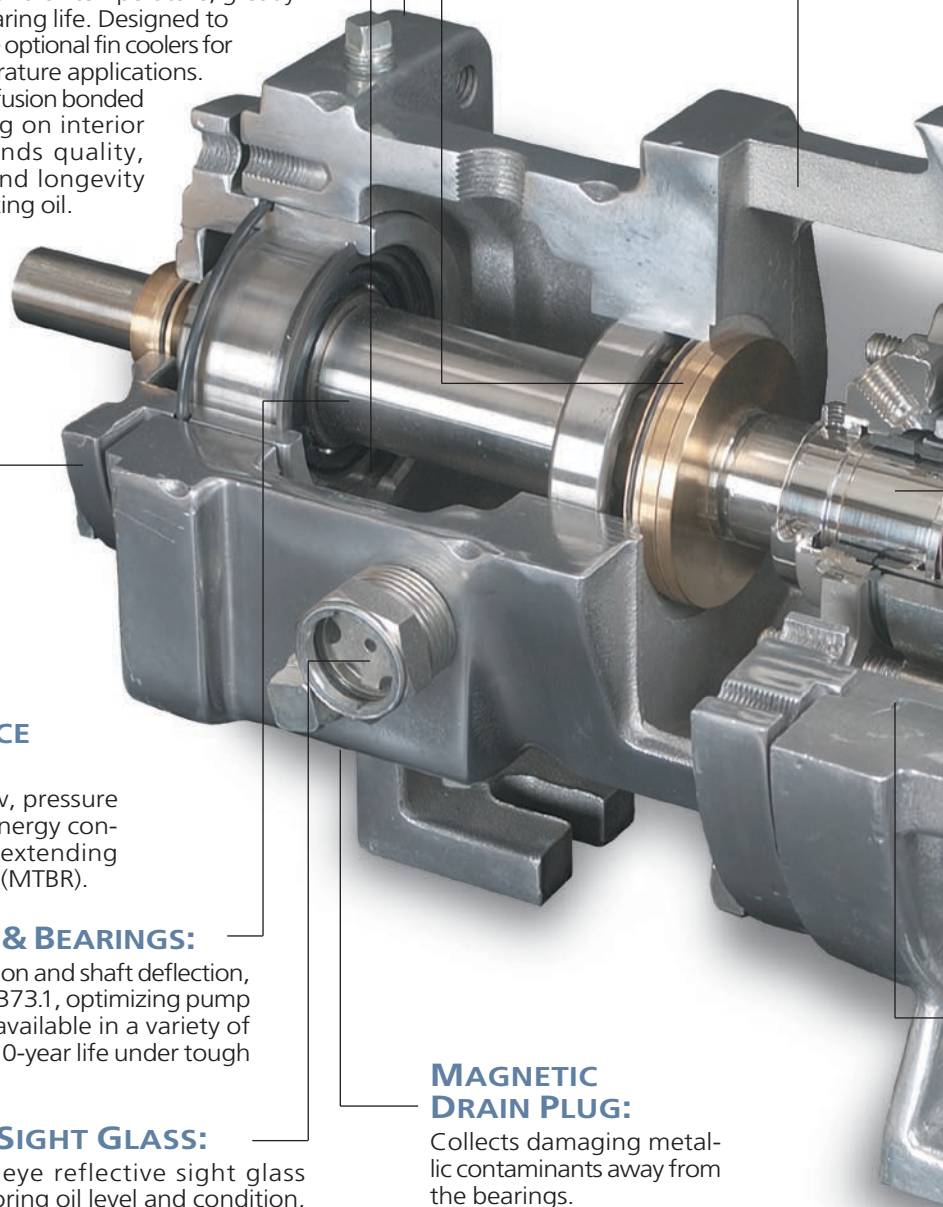

EXTERNAL CLEARANCE ADJUSTMENT:

For maintaining original flow, pressure and efficiency, minimizing energy consumption and repairs, and extending Mean-Time-Between-Repair (MTBR).

HEAVY-DUTY SHAFT & BEARINGS:

Engineered to minimize vibration and shaft deflection, less than 0.002 inch per ANSI B73.1, optimizing pump life. Sleeved and solid shaft available in a variety of materials. Bearings sized for 10-year life under tough operating conditions.

OVERSIZED SIGHT GLASS:

One-inch bulls eye reflective sight glass facilitates monitoring oil level and condition, critical to bearing life. Bottle oiler optional.

MAGNETIC DRAIN PLUG:

Collects damaging metallic contaminants away from the bearings.

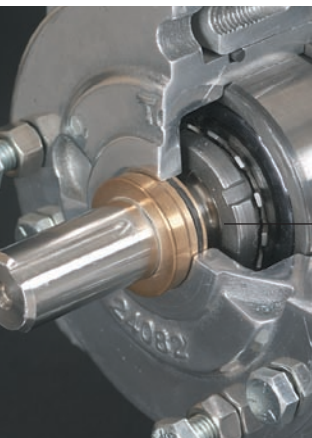

ODEL DESIGN

CHANGES ANY COMPETITIVE BRAND

EXTRA-HEAVY CASINGS:

Class 150 pumps incorporate Class 300 wall thickness as standard, extending reliability and casing life under severe corrosive/erosive conditions:

- Top centerline, self-venting discharge for air handling
- Back pull-out to simplify maintenance
- Rigid casing feet prevent pipe load misalignment and promote seal/casing life
 - Discharge connection for pressure gauge or seal bypass flush connection standard on Ductile Iron and Stainless Steel casings
 - Class 150 FF standard for positive sealing. Optional Class 150 RF 300 FF/RF available
 - Casing drain standard in Ductile Iron and Stainless Steel for simplified maintenance.

FULLY OPEN IMPELLER:

With double the wear area of enclosed models, the 811 impeller offers superior handling of solids, corrosives and abrasives. Back pump-out vanes reduce hydraulic loads and seal chamber pressure.

SEALING FLEXIBILITY:

Wide range of sealing options coupled with seal chambers and stuffing boxes selected for service condition to improve lubrication and heat dissipation of seal faces, maximizing pump uptime.

CONTAINED CASING GASKET:

Provides positive sealing at casing joint to prevent "blow out" of liquids and to facilitate disassembly.

INTERCHANGEABILITY GUIDE

All 811 parts, from end to end, are 100% interchangeable with many ANSI pumps. Ask for our 56-page Parts Guide—your tool for cross-referencing Griswold 811 to comparable pumps by size and part number!



OPTIMIZE YOUR PUMP REPLACEMENT PROCESS

Challenge your existing equipment quality, delivery and costs with Griswold's ready-to-ship inventory of 811 pumps and parts. Our high-quality, ANSI-compliant pumps and wearing parts will interchange quickly and seamlessly with a variety of ANSI pump models and brands—without piping, base-plate or coupling changes. All at a significant cost savings!

Factor in our **NO PREMIUM 36-HR SHIP COMMITMENT** on pumps and **NEXT-DAY SHIPPING** on parts, and you'll **save money, simplify ordering, reduce inventory and expedite line repair.**

INTERCHANGEABLE WITH:

PUMPS:

- ✓ Ductile Iron pumps
- ✓ Stainless Steel pumps
- ✓ Alloy 20 pumps
- ✓ CD4MCu pumps

PARTS:

- ✓ Bearings & seals
- ✓ Cases
- ✓ Impellers
- ✓ Power frames
- ✓ Shafts & sleeves
- ✓ Stuffing boxes
- ✓ all other parts for ANSI pumps

GRISWOLD 811LF

ANSI PROCESS PUMPS DESIGNED FOR L

INCREASED CAPABILITY FOR REDUCED VOLUMES

Standard ANSI pumps (with expanding style volute casing) are not designed for low flow, high head applications: the excessive radial loads and shaft vibration experienced can shorten bearing and seal life. Griswold's Model **811LF** series is designed with a circular concentric casing in conjunction with a radial vane impeller to reduce those excessive radial loads and minimize shaft deflection, thus extending MTBPM.



1 CIRCULAR CONCENTRIC VOLUTE CASING:

The fully machined concentric volute reduces excessive radial loads experienced in low flow, high head applications. Shaft vibration and deflection is minimized, extending bearing and mechanical seal life.

Class 150 raised face flanges are standard with the Model **811LF** series for positive sealing. Class 300 raised face flanges are available as an option.

2 LOW FLOW RADIAL VANE IMPELLER:

Griswold's radial vane impellers are specially designed to reduce the thrust load and seal chamber pressure normally associated with low flow applications. When operating in reduced volume conditions, the low flow impeller's vanes provide better hydraulic control than traditional ANSI impellers. Balance holes reduce both axial thrust and seal chamber pressure, extending bearing and seal life.

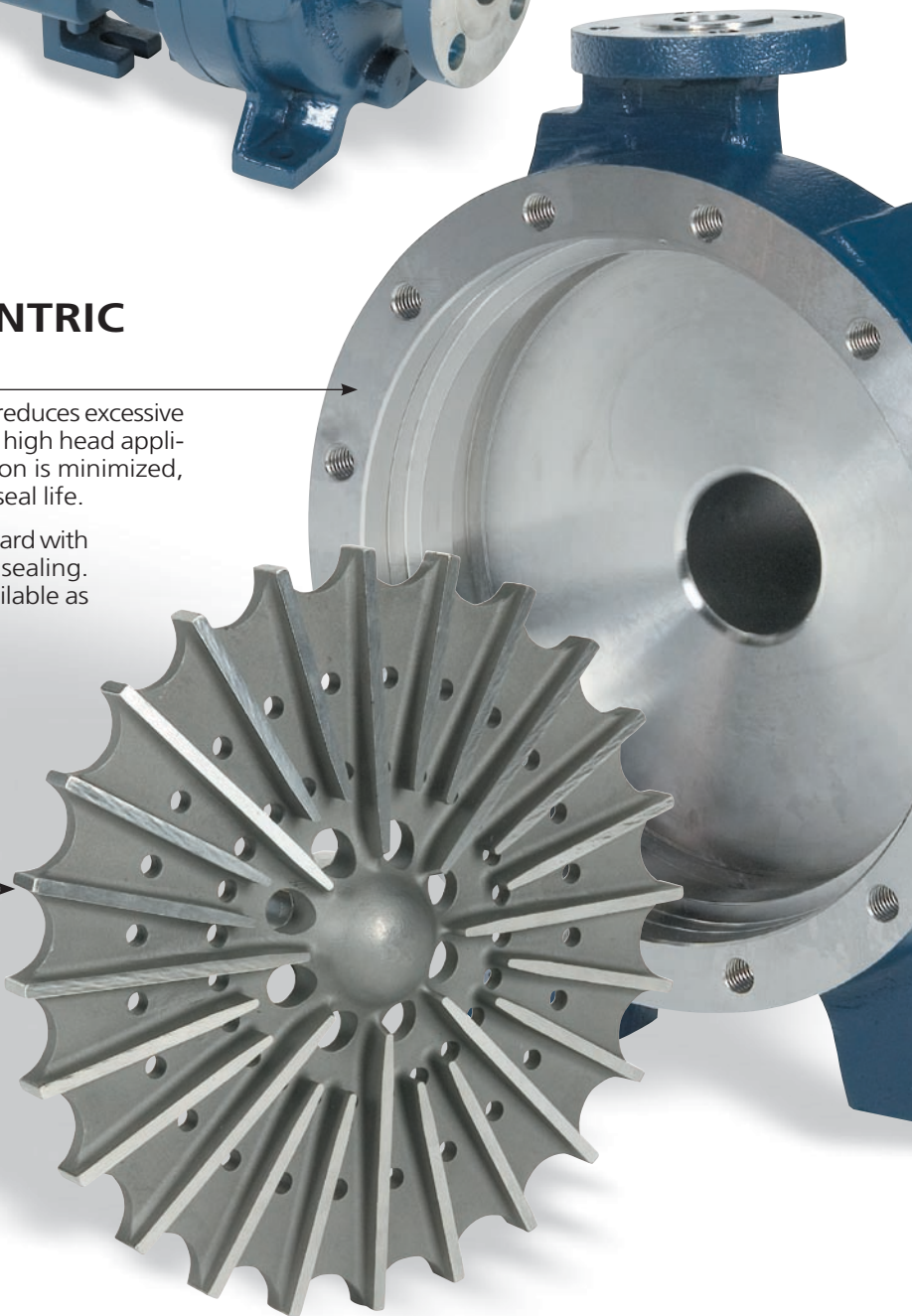

FOR LOW FLOWS

LOW FLOW SERVICES.

3

811LF PERFORMANCE:

With a traditional ANSI pump, throttling or recirculating flow to attain low flow conditions causes excessive radial load and shaft deflection—all of which can result in premature failure to bearings and mechanical seals.

Griswold **811LF** pumps feature flow capacities as low as 4 GPM, and heads as high as 920'—low flow/high head performance you can count on to further extend your MTBPM.

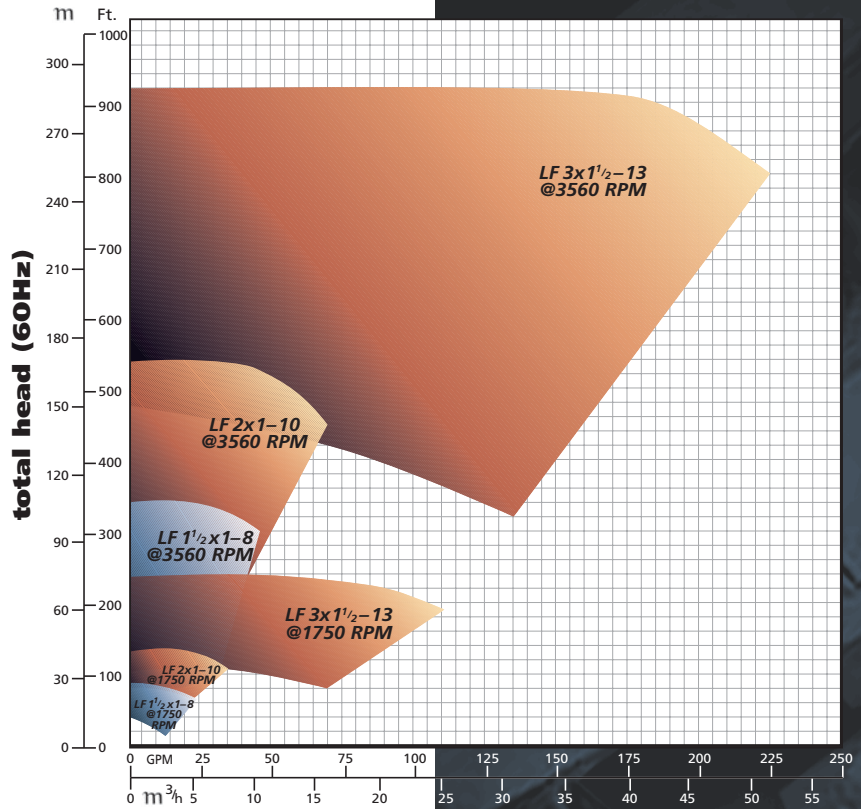

4

RETROFITTING:

Griswold Model **811LF** pumps are ANSI dimensional, so they can be installed without piping or base changes to existing equipment. In fact, since all other parts and features are identical/interchangeable within the entire 811 ANSI line, the **811LF** case and impeller can be easily retrofitted to an existing Griswold pump as well as 100,000s of other ANSI pumps already in service!

capacity (60Hz)

SIX 811LF MODELS

- LF 1½ x 1-8 @ 1750 RPM
- LF 1½ x 1-8 @ 3500 RPM
- LF 2 x 1-10 @ 1750 RPM
- LF 2 x 1-10 @ 3500 RPM
- LF 3 x 1½-13 @ 1750 RPM
- LF 3 x 1½-13 @ 3500 RPM

811LF CAPACITIES

4 GPM to 210 GPM
Heads to 920'

GRISWOLD 811FO

SUPERIOR CONSTRUCTION. EXTRAORDINARY PERFORMANCE.

1

HEAVY-DUTY CASTINGS:

- **Wide Choice of Materials.** Your choice of standard stocked materials for Model 811 centrifugal pumps includes Ductile Iron, 316 Stainless Steel, CD4MCu and Alloy 20. Other alloys available.
- **Superior Casting Finishes.** Investment and no-bake casting processes ensure smooth, precise, superior finishes that guarantee consistent, reliable performance.
- **Controlled Solution Annealing.** Metallurgists strictly supervise all heat-treating operations to assure maximum corrosion-resistance for all alloys.

C O M P A R E

- Increases Performance ✓
- Increases Longevity ✓
- Simplifies Maintenance ✓



2

FULLY OPEN IMPELLER:

C O M P A R E

- Increases Performance ✓
- Increases Longevity ✓
- Simplifies Maintenance ✓

- **Ideally Suited for Chemical Process Industry Applications.** Because it has two times the area in the critical casing and stuffing box/seal chamber clearances, Griswold's Open Impeller is far superior to its typical enclosed counterpart. Our open design minimizes concentrated wear by balancing hydraulic axial thrust load and reducing stuffing box pressure. This not only facilitates corrosive, abrasive, solid and stringy fiber handling, but also simplifies maintenance, extends life and reduces repair costs.

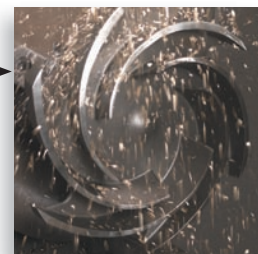

- **Self-Tightening to Reduce Leaks and Failures.** Our impeller design is further enhanced by threading on the shaft and sealing through a controlled squeeze contained o-ring to eliminate bolt loosening with system changes or high temperatures. Metal-to-metal contact ensures optimal running and transmittal of torque and alignment. Because we eliminate the impeller bolt, we also eliminate corrosion or gasket leakage, ensuring that smooth entrance contour and lower NPSH requirements are realized.

- **External Clearance Adjustment.** Peak efficiency is ensured through simple maintenance to account for wear area loss. Adjustment is quick and easy to set at the site with an ordinary open-end wrench—no shims or shop maintenance needed, as with enclosed impellers. The external clearance adjustment moves the impeller forward to reestablish original clearance and hydraulic pressure without disassembly or replacement of wear rings.

- **Back Pump-Out Vanes** reduce pressure on the shaft seal and axial thrust on the bearings. Maintenance is further simplified—extending bearing life, seal life and performance.

- **Investment Cast Impellers.** Ultra-smooth, consistently cast investment impellers are standard on Stainless Steel, CD4MCu and Alloy 20, and optional on Ductile Iron pumps. This feature improves hydraulic and mechanical balance, maximizes seal and bearing life and improves efficiency.





R THE LONG RUN

PERFORMANCE. EXCEPTIONAL ENDURANCE.

3 SEAL CHAMBERS & SEALING FLEXIBILITY:

Our quality seal chambers are engineered to provide optimum seal environment for heat dissipation, solids, entrapped air and vapor. Oversized seal chambers increase radial clearance between the mechanical seal and seal chamber, as well as provide better circulation of liquid to and from the seal faces, preventing failure of the shaft seal. A variety of flush plans are available for additional lubrication and cooling of the seal faces.

	Standard Bore	Large Bore	Tapered Bore
			
Services	Services utilizing packing or mechanical seals. For mild fluid at ambient temperatures.	Most services including those with solids greater than 10%. Increased radial clearance between seal & chamber for improved liquid circulation, lubrication & cooling.	Services up to 10% solids or those containing entrained air or vapors. For lower seal face temperatures, self venting & draining. Circulates solids & vapors away from seal faces.
Sealing Flexibility			
Packing	Most Services	Not Available	Not Available
Single Seal/No Flush	Not Recommended	Not Recommended	Services with Solids up to 10%
Single Seal/With Flush	Mild, Clear Fluids	Most Services including Solids above 10%	All Services with Solids up to 10%
Conventional Double Seal with Seal Plan	Zero Leakage Applications	Zero Leakage Applications	Not Available
Cartridge Double Seal with Seal Plan	Zero Leakage Applications	Zero Leakage Applications	Zero Leakage Applications

5-YEAR Whole Pump Warranty.

All 811 pumps are backed by a 5-YEAR unconditional guarantee against defects in material and workmanship.







4 SEALS TO FIT ANY APPLICATION:

Cartridge Seals, Component Seals & Conventional Packing. With Griswold's broad selection of seals, you can accommodate most any fluid and temperature for demanding chemical, petroleum, pharmaceutical and general industry applications. Our engineers can recommend the best seal to maximize your application and system life—including cartridge or component, single or double, inside or outside, balance or unbalanced seals or conventional packing.



SEAL SELECTION

- 
Single Inside Seal:
 For non to moderately corrosive liquids, moderate abrasives and liquids with good lubrication qualities.
- 
Conventional Double Seal:
 For liquids that are incompatible with single seals, cavitation or low flow situations. Meets environmental regulations for toxic, hazardous, abrasive and corrosive substances.
- 
Single Cartridge Seal:
 For same applications as conventional single seals, allowing simplified seal setting and maintenance.
- 
Double Cartridge Seal:
 For same applications as conventional double seals, allowing simplified seal setting and maintenance.
- 
Double Gas Barrier Seal:
 Meets environmental regulations for toxic or hazardous materials. For use when seal pot or external flush is not desirable or when compatible seal flush liquid is not available.

GRISWOLD 811FO

SUPERIOR CONSTRUCTION. EXTRAORDINARY PERFO

5 ENHANCED POWER FRAMES:

C O M P A R E	Increases Performance ✓
	Increases Longevity ✓
	Simplifies Maintenance ✓

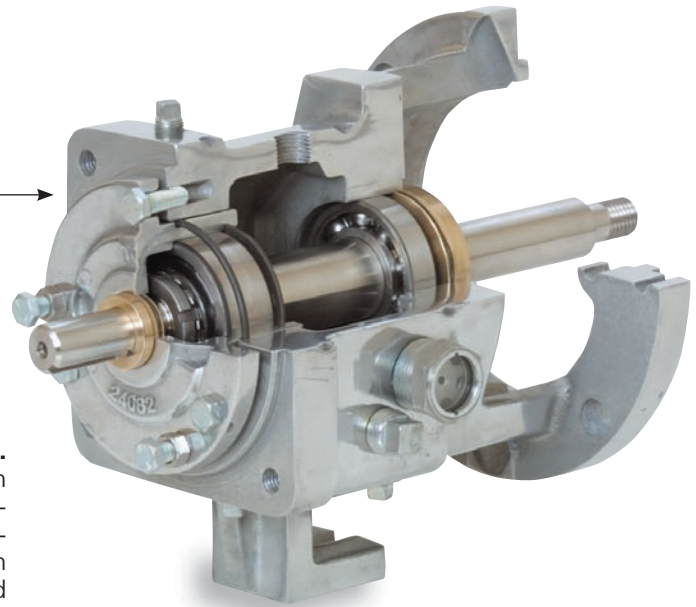

- **INPRO® Labyrinth Oil Seals.** Our high-quality oil seals keep outside environmental contaminants from entering your lubrication media, greatly extending bearing life—available standard in bronze, and optional in Carbon-filled Teflon® or magnetic seal face.

- **Large Sight Glass.** Our one-inch bulls eye sight glass simplifies oil level and conditions monitoring, critical to bearing life.

- **Large Oil Sump & Oversized Fill Plug.** Increased oil capacity maximizes heat transfer for reduced oil temperature. Our extra large 1/2" NPT oil fill plug further simplifies the lubrication process. Designed to accommodate optional fin coolers for higher temperature applications.

- **Powder Coated Oil Sump Lining.** Griswold utilizes a "Fusion Bonded Epoxy Coating" on the interior surface of the power frame to provide an impenetrable barrier between the iron frame and oil, enhancing the long-term quality and cleanliness of the lubricating oil.

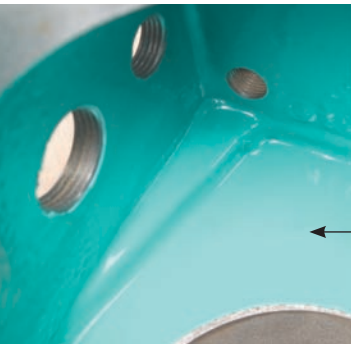

- **Improved Strength & Rigidity.** The superior tensile strength of both our cast and ductile iron makes Griswold power frames not only stronger than the competition's (as much as 33%), but also more rigid—and better equipped to withstand forces and moments experienced in today's process applications. (see chart next page)

- **Heavy-Duty Shaft & Bearings.** Our shaft is engineered for heavy-duty loads and for minimum vibration and deflection at seal faces (less than 0.002 inches per ANSI B73.1), extending bearing and seal life. Using only the highest-quality bearings further optimizes the 811's performance and reliability. Both shaft and bearings are rated for 10-year average life under tough operating conditions. Standard hook-type sleeved design meets ANSI shaft deflection standards and provides ease of maintenance. Solid shaft design available for more demanding applications. Both are available in a variety of materials.

- **Hook-Type Replaceable Shaft Sleeve.** The 811's hook-type shaft sleeve is free to expand with temperature changes and promotes renewal of the sealing surface without bearing and shaft disassembly.

- **Magnetic Drain Plug.** Our drain plug is designed to magnetically collect damaging metallic contaminants away from the bearings.

- **Monitoring Locations.** Each power frame is machined with 4 condition-monitoring sites to facilitate consistent checking of vibration and temperature.

- **Clean Room Assembly.** All sizes of our power frames are assembled in Griswold's climate controlled, sealed, clean room which filters out airborne dirt and debris that might otherwise contaminate sensitive bearings and internal components. We also inventory all finished power frames and associated components in this ultra clean environment to ensure the most reliable power frame you can buy.



R THE LONG RUN

PERFORMANCE. EXCEPTIONAL ENDURANCE.

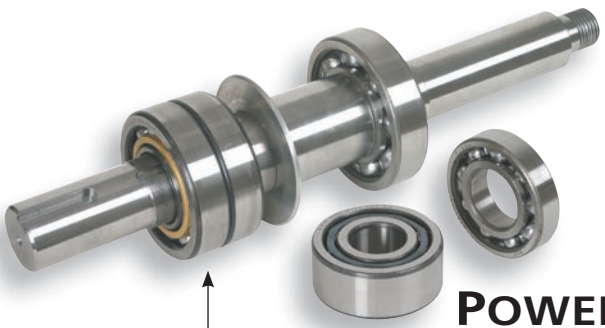

POWER FRAME UPGRADE:

- COMPARE
- Increases Performance ✓
 - Increases Longevity ✓
 - Simplifies Maintenance ✓

• **811 L.** The 811 is offered in a larger frame that is ideal in high-load applications or when conditions push the power frame beyond ANSI limits. The 811 L features an oversized rotating assembly and higher radial and thrust load carrying bearings. Duplex angular contact bearings insure zero end play for improved sealing and maximum mechanical seal life. Whether pumping viscous liquids or high specific gravity liquids, fluctuating process conditions, or pumping high heads or low flows, our 811 L power frame guarantees maximum pump life in your toughest applications.



HEAVY DUTY C-FACE MOTOR ADAPTER:

- COMPARE
- Increases Performance ✓
 - Increases Longevity ✓
 - Simplifies Maintenance ✓

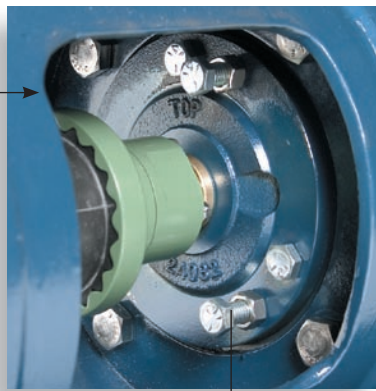

• **Optional C-Face Adapter.** Our C-Face motor adapter bolts directly to the precision machined fit on the power frame. Register fits on both ends of the adapter lock in a standard C-Face motor, guaranteeing both parallel and angular alignment. This quick, yet precision installation minimizes time spent aligning shaft couplings, and eliminates seal and bearing replacements caused by misalignment. Best of all, our C-Face adapters—like the rest of our parts—are directly interchangeable with most ANSI pumps!

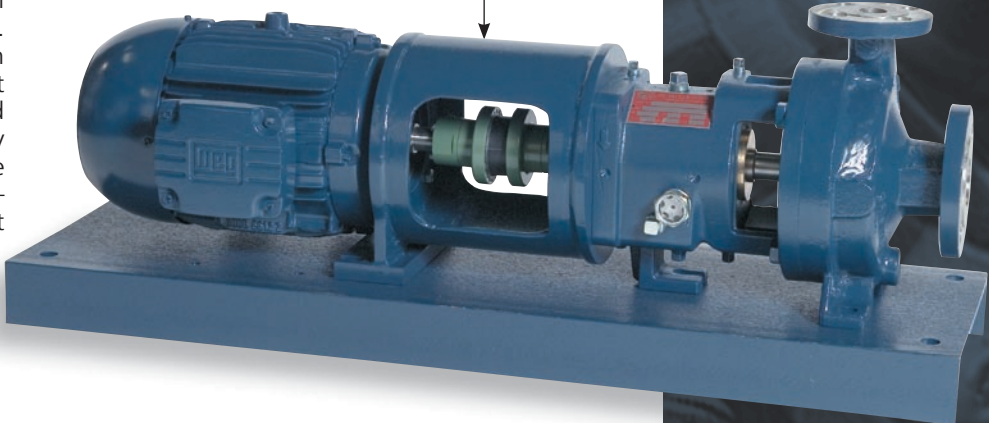

GRISWOLD'S STANDARD FEATURES STACK UP!

Power Frame Standard Feature Comparison:	Griswold	Competition
Magnetic Drain Plug	YES	No
INPRO® Lab Seals	YES	No
Epoxy Coated Interior	YES	No
Clean Room Assembly	YES	No
Cast Iron Tensile Strength <small>MTX, LTX & XLTX Frames</small>	30000 lbs	20000 lbs
Ductile Iron Tensile Strength <small>STX Frames</small>	65000 lbs	60000 lbs

GRISWOLD 811 SU

W E ' V E

Extensive OPTIONS

Comprehensive SUPPORT

At Griswold, our commitment to your success extends way beyond our top-of-the-line products. We've structured our staff, systems and inventory to deliver consistent high-level solutions for meeting your most critical equipment and emergency delivery needs. We pride ourselves in providing WHAT you need, WHEN you need it, and the CONFIDENCE and RELIABILITY to make your job easier.

1 ENGINEERING & CUSTOMER SUPPORT

- **Equipment Selection:** Our application engineers utilize the latest software to identify the optimum pump for your application, as well as component and seal specifications.
- **Technical Support:** Our engineering staff stands ready to answer any questions regarding performance and repair. Our state-of-the-art test center is available for a number of certified performance tests, either witnessed or non-witnessed, and conforms to Hydraulic Institute Standards.



engineering support



certified testing

Griswold offers a broad range of options and upgrades to tailor the 811's handling and performance to meet virtually any fluid processing application. You can rely on our engineering staff to assist you in configuring pump size, material and components to best suit your specific plant and processing requirements.



BASEPLATE MOUNTING SYSTEMS

COMPARE

- 811**
- other brands

Griswold offers a complete range of pre-engineered rigid baseplates designed to reduce stress and vibration as well as extend MTBPM, thus ensuring long-term durability. Our wide selection of metallic and non-metallic baseplates provides flexibility in selecting the best base to fit your operating needs and budget. Bases include a fully enclosed steel coupling guard as standard, with optional non-sparking coupling guard available.

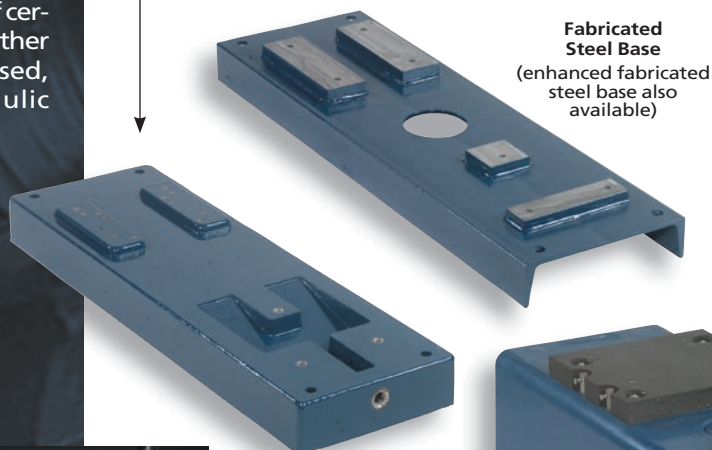

Fabricated Steel Base
(enhanced fabricated steel base also available)

Composite Base



Composite Foundation Base



HIGH & LOW TEMPERATURE CAPABILITY

COMPARE

- 811**
- other brands

- **Heat Jacket:** Clamps on to the casing to manage heat transfer. Easy to install or remove for servicing.
- **Jacketed Seal Chamber:** Maintains temperature control for heating or cooling of sealing environment.
- **Bearing Frame Finned Cooler:** Directly cools oil to lower bearing temperature. Recommended for temperatures over 350 degrees.

PERIOR SOLUTIONS

G O T Y O U C O V E R E D



4

LUBRICATION OPTIONS

811 power ends accommodate all lubrication systems, including flood oil, oil mist and grease lubrication. Our power ends are pre-drilled for all lubrication methods and can be easily converted in the field without modification.

COMPARE

811

other brands

3

SEAL FLUSH PLANS

We offer all ANSI B73.1 seal flush and cooling plans to control emission levels, improve lubrication and cooling of the seal faces, and reduce downtime. Ask us to assist you in selecting the best plan.

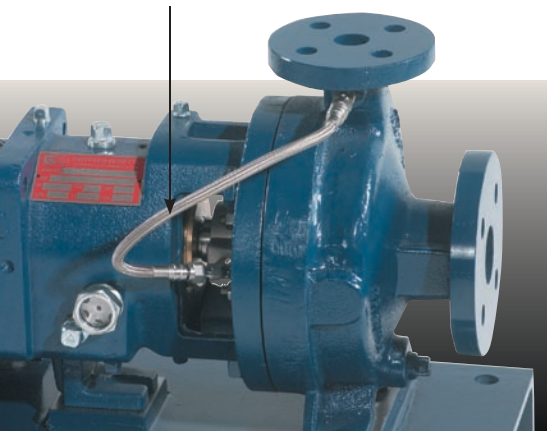

COMPARE

811

other brands



3

SPECIAL SURFACE PREPARATION

Griswold offers a variety of optional surface preparation processes for extended corrosion protection and contaminant-free pumping:

- Electro Polishing
- Passivation
- Hard Metal Coatings
- Fusion Bonded, Epoxy Coated Power End
- Special Paint Systems

COMPARE

811

other brands

Comprehensive SUPPORT

2 INVENTORY OPTIMIZATION

The Griswold staff, along with our stocking distributors, can review your pumps and parts usage to recommend upgrades and optimize your on-site inventory, minimizing stocking hassles and your long-term operating costs. Because we offer *identical* features, interchangeability and quality as hundreds of thousands of pumps and parts worldwide, at **30-40% savings**, we can improve your existing process and reduce your total cost of ownership.



3 EXPEDITED DELIVERY

36-Hour Ship Commitment on Entire Pumps, Next-Day Shipping on Parts:

Griswold offers the quickest delivery response in the industry. When your production quota is on the line, each day of downtime waiting on a repair can mean several hundred thousand dollars of revenue, unfulfilled critical shipments, and lost jobs. Factor those statistics into your total costs of ownership! Maintaining an extensive inventory at our headquarters and stocking distributors, we can make this commitment—or better—without the additional premiums our competitors charge.

36-HOUR SHIPPING COMMITMENT!

(NEXT DAY ON PARTS)

811

PERFORMANCE &

3500 2850 RPM

PERFORMANCE
CURVE

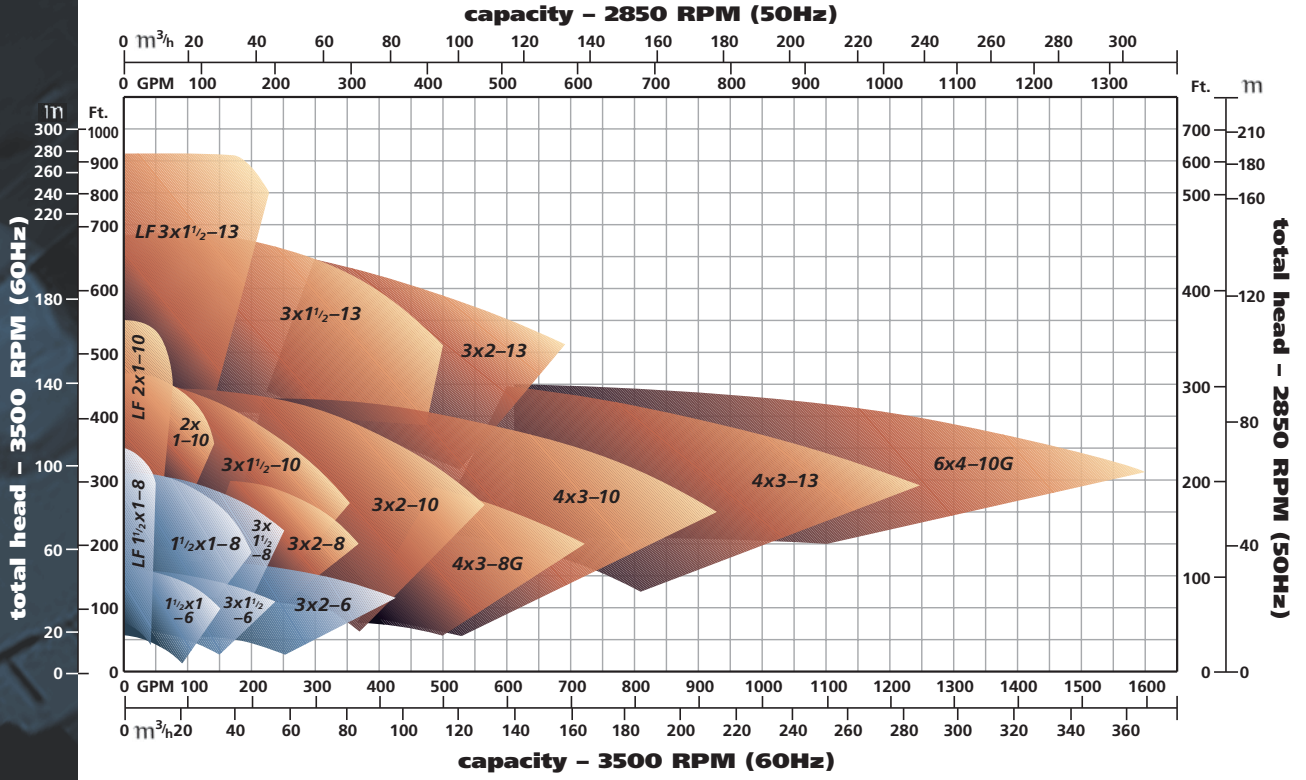

1750 1450 RPM

PERFORMANCE
CURVE

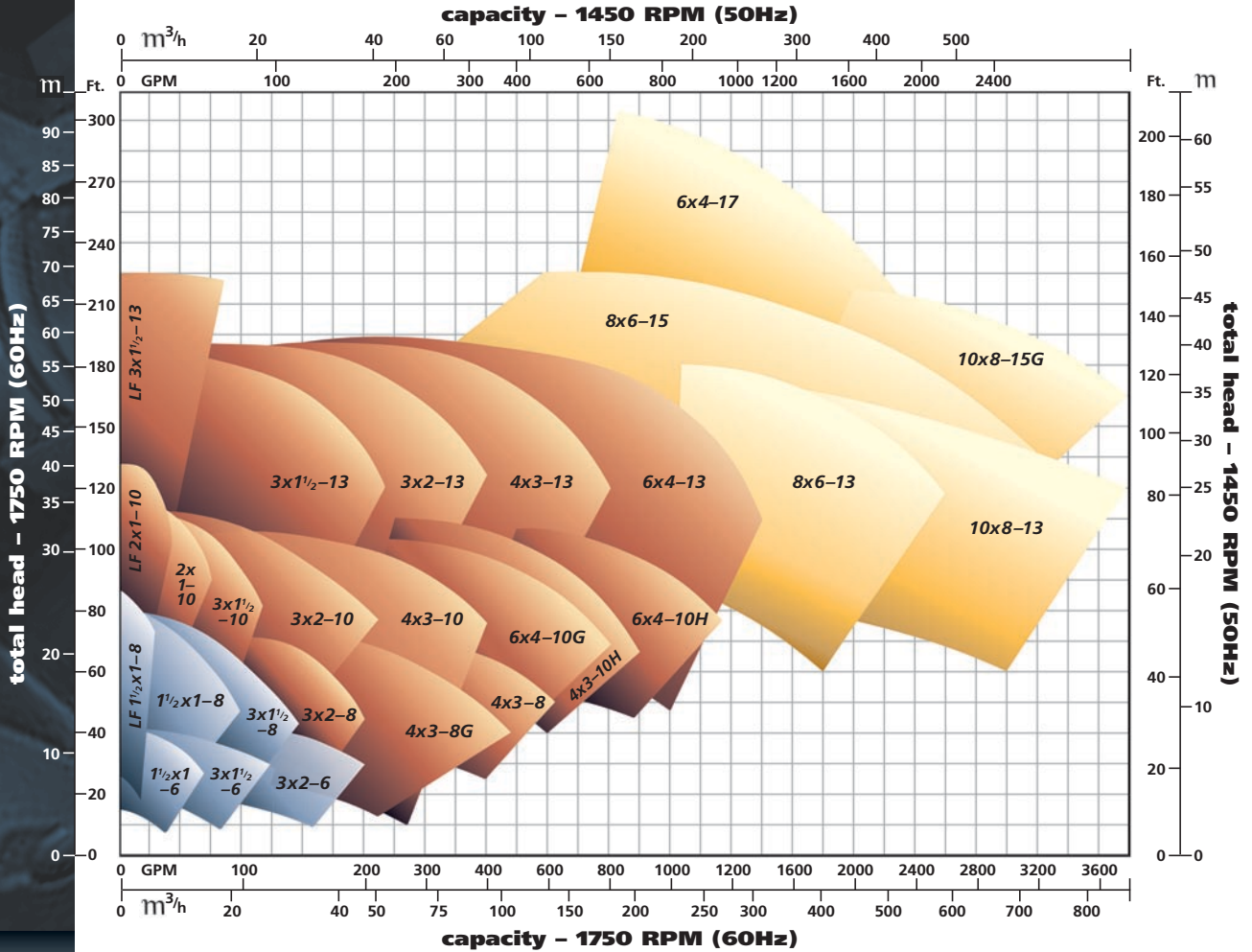

CONSTRUCTION DETAILS

construction details

Griswold 811 Model		Model 811S	Model 811M	Model 811L	Model 811XL
Volute		single			
Nominal Case Thickness (in.)		3/8	1/2 (6x4-13A80 = 5/8)		9/16
Corrosive Allowance @ Max.		1/8			
Working Pressure		Limits set by ANSI B16.5			
Max. Working PSIG		See Pressure/Temp. charts on following page			
Hydro Test PSIG @ 100°F		150% of working pressure at 100°F (38°C)			
Max. Liquid Temp. (°F)		350°F without Cooling / 500°F with Cooling			
Shaft Diameter	At Coupling (in.)	7/8	1 1/8	1 7/8	2 3/8
	Sleeve Dia. Under Seal (in.)	1 3/8	1 3/4	2 1/8	2 1/2
	Under Impeller (in.)	3/4	1	1 1/4	1 1/2
	Under Sleeve (in.)	1 1/8	1 1/2	1 7/8	2
	Overhang (in.)	6 1/8	8 3/8	8 3/8	9 31/32
Bearings	Radial	SKF 6207	SKF 6309	SKF 6311	SKF 6313
	Thrust	SKF 5306 A/C3	SKF 5309 A/C3	SKF 7310 BECBM	SKF 5313 A/C3
	Bearing Span	4 1/8	6 3/4	6 7/8	9 1/4
Mechanical Seal Size (in.)		1 3/8	1 3/4	2 1/8	2 1/2
Stuffing Box Standard Bore	I.D. (in.)	2	2 1/2	2 7/8	3 3/8
	Depth (in.)	2 1/8	2 5/8		3
Stuffing Box Large Bore	I.D. (in.)	2 1/2	2 13/16		2 15/16
	Depth (in.)	2 1/8	2 5/8		3
Stuffing Box Large Bore	I.D. (in.)	2 7/8	3 1/2	3 7/8	4 1/2
	Depth (in.)	2 1/8	2 5/8		3
	Distance End of Box to Nearest Obstruction	2 3/16	2 13/16		2.85
Lantern Ring Width (in.)		7/16	5/8		5/8

component interchangeability

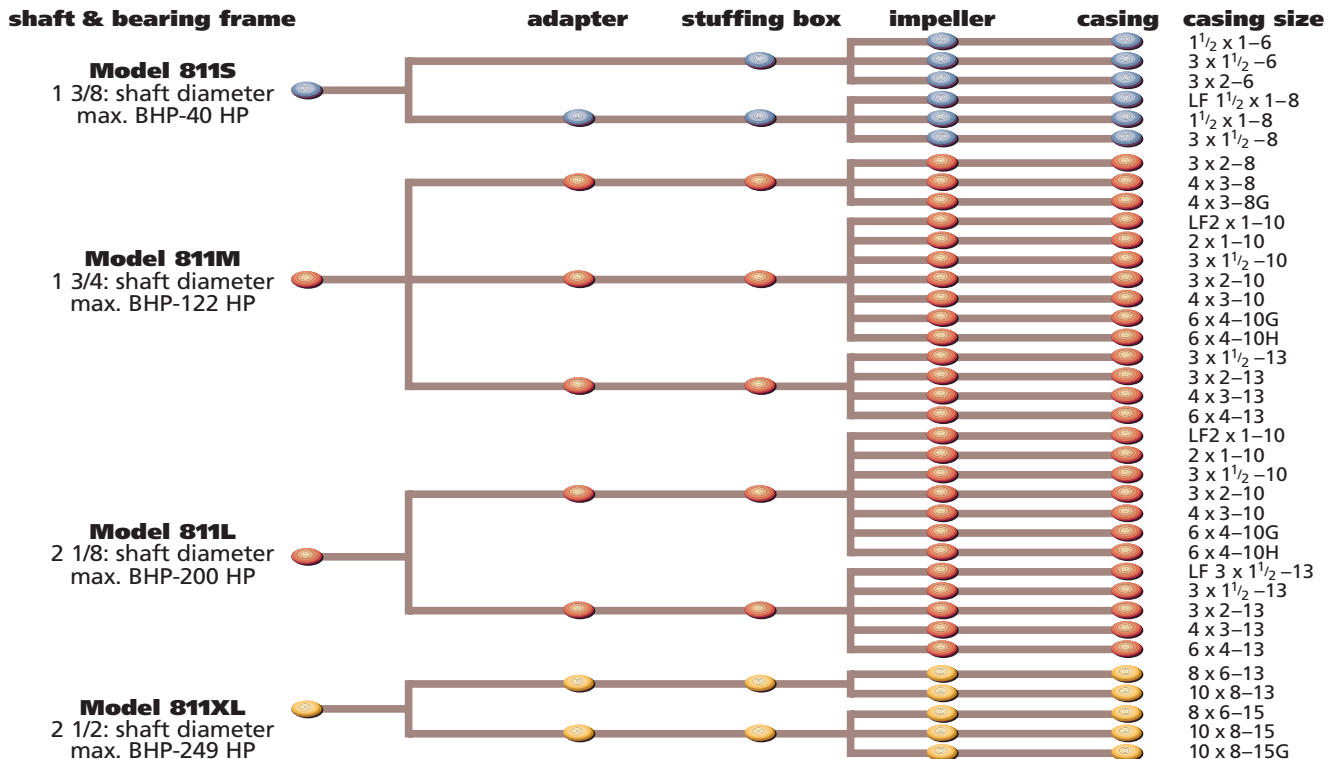

811 PARTS, MATERIAL

parts list **key**

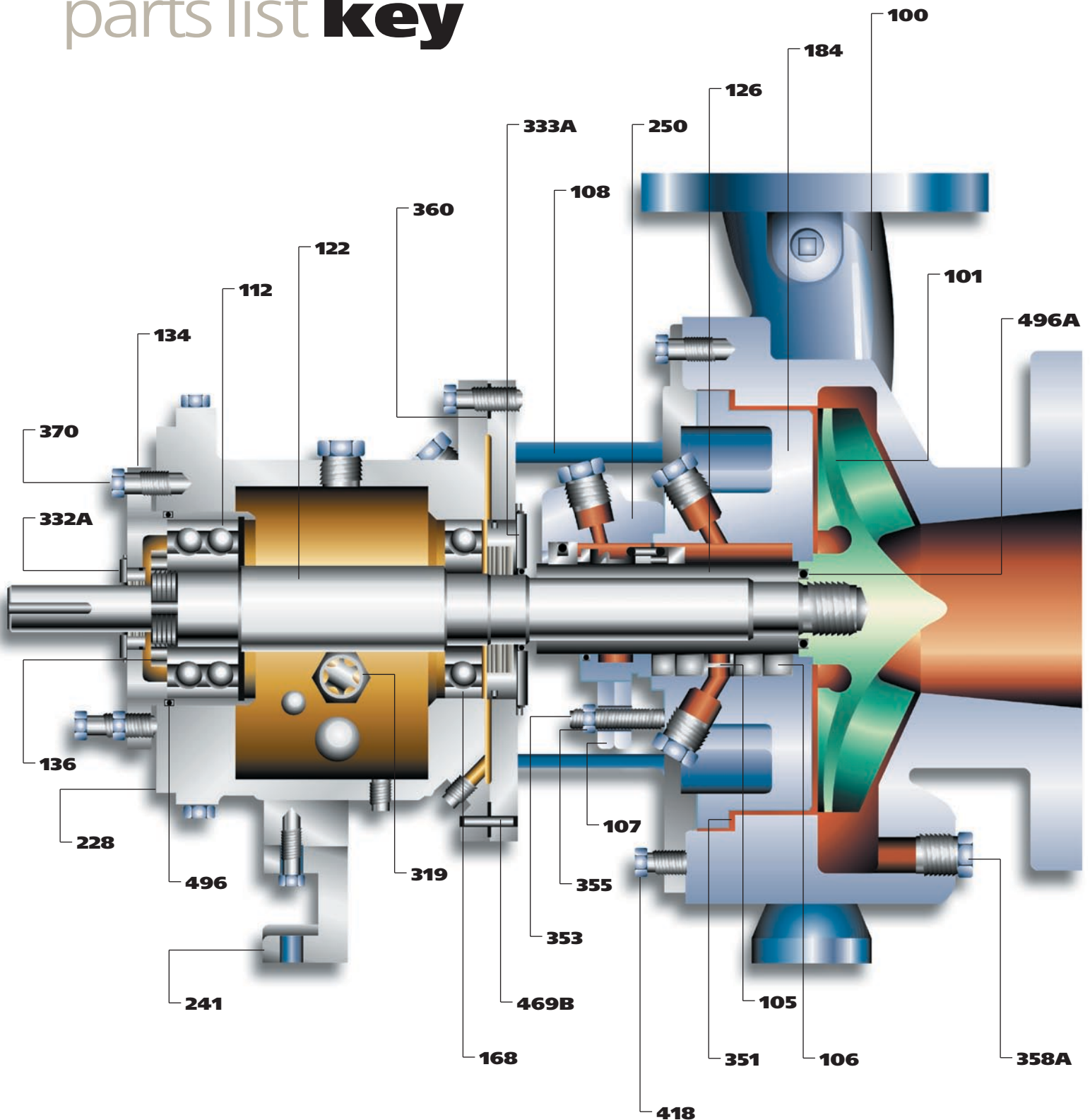

& MISC. SPECIFICATIONS

parts &
material
composition

ITEM NO.	REQ'D PER PUMP	PART NAME	ALL DUCTILE IRON	ALL 316SS	ALL ALLOY 20	ALL CD4MCu	ALL MONEL	HAST-ELLOY B&C	
100	1	Casing	DI	316SS	Alloy 20	CD4MCu	Monel	B&C	
101	1	Impeller	DI	316SS	Alloy 20	CD4MCu	Monel	B&C	
105	1	Lantern Ring	Glass Filled TFE						
106	1	Packing	SIL C-8201 Acid Rest.		TFE				
107	1	Packing Gland	316SS		Alloy 20		Monel	B&C	
108	1	Frame Adapter	Ductile Iron						
112	1	Outboard (Thrust) Bearing	Double Row Angular Contact**						
122	1	Shaft - Less Sleeve (Optional)	316SS						
122	1	Shaft - With Sleeve	SAE4140				316SS		
126	1	Shaft Sleeve	316SS		Alloy 20		Monel	B&C	
134	1	Bearing Housing	Cast Iron						
136	1	Lock Nut / Lock Washer	Steel						
168	1	Inboard (Radial) Bearing	Single Row Deep Groove						
184	1	Stuffing Box	DI	316SS	Alloy 20	CD4MCu	Monel	B&C	
228	1	Frame	Cast Iron (Ductile for Small Frame)						
241	1	Frame Foot	Cast Iron						
250	1	Gland	316SS		Alloy 20				
319	1	Sight Oil Gauge	Cad. Plated						
332A	1	Labyrinth Oil Seal (Outboard)	Bronze (Optional Carbon Filled Teflon)						
333A	1	Labyrinth Oil Seal (Inboard)	Bronze (Optional Carbon Filled Teflon)						
351	1	Casing Gasket	Aramid Fiber with EPDM Rubber						
353	4	Gland Stud	316SS						
355	4	Gland Nut	304SS						
357K	2	Hex Nut	304SS						
358A	1	Casing Drain Plug (Optional)	Steel	316SS	Alloy 20	316SS	Monel	Hastelloy	
360	1	"Gasket, Frame-to-Adapter"	Vellumoid						
360A	1	"Gasket, Bearing End Cover"	Vellumoid (811XL Only)						
370	3	Brg. Hsg.Hex Bolt	Steel						
418	3	Cas. Jack Screw	Steel						
469B	2	Dowel Pin	Steel						
496	1	Brg. Hsg. O-Ring	Buna Rubber						
496A	1	Impeller O-Ring	Glass Filled TFE						

** 811L Power End features Duplex Angular Contact

pressure &
temperature
capability

Maximum Working Pressure Limits
models 811S, 811M, 811L; Class 150 Flanges

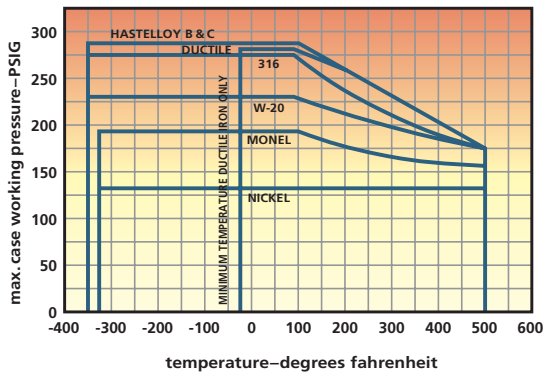

Maximum Working Pressure Limits
models 811S, 811M, 811L; Class 300 Flanges

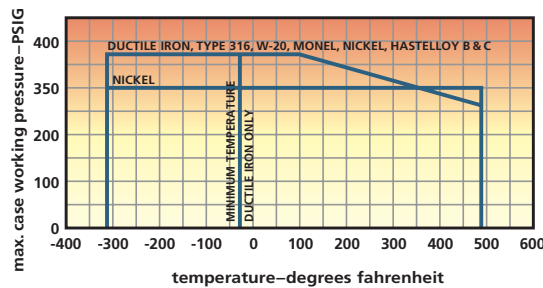

Note: Final selections must be based on temperature and pressure limits given in general data section.

811

DIMENSIONAL, B

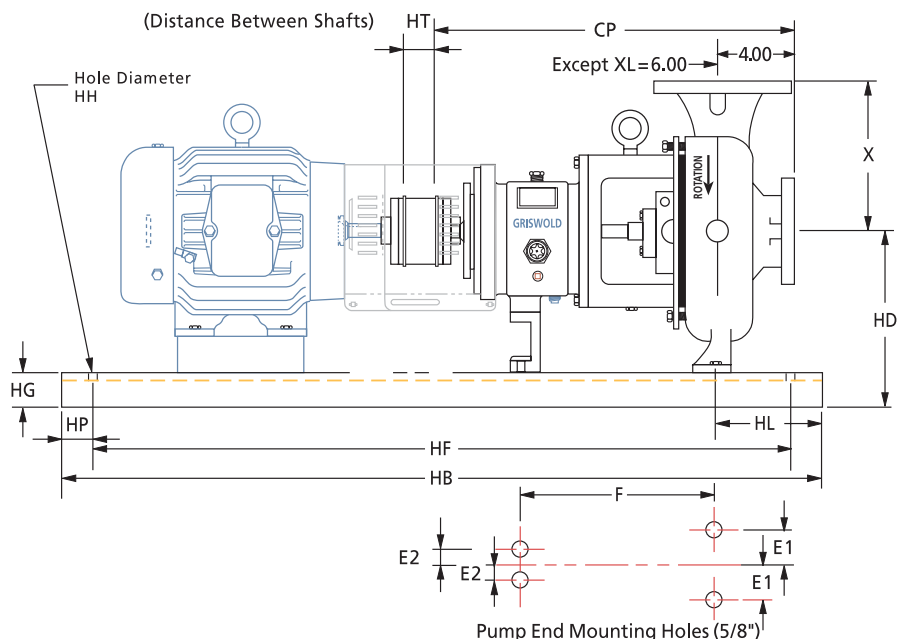

small
PUMP END &
BASEPLATE

PUMP END DIMENSIONS												
	Pump Size	ANSI Designation	Discharge	Suction	D	X	CP	E1	E2	F	Impeller Eye (sq in)	Max.Diam Solids
SMALL	1 1/2 x 1 - 6	AA	1	1 1/2	5 1/4	6 1/2	17 1/2	3	0	7 1/4	3.1	11/32
	3 x 1 1/2 - 6	AB	1 1/2	3	5 1/4	6 1/2	17 1/2	3	0	7 1/4	7.1	7/16
	3 x 2 - 6	AC	2	3	5 1/4	6 1/2	17 1/2	3	0	7 1/4	6.5	3/8
	1 1/2 x 1 - 8	AA	1	1 1/2	5 1/4	6 1/2	17 1/2	3	0	7 1/4	3.5	11/32
	LF 1 1/2 x 1 - 8	AA	1	1 1/2	5 1/4	6 1/2	17 1/2	3	0	7 1/4	3.1	3/16
	3 x 1 1/2 - 8	AB	1 1/2	3	5 1/4	6 1/2	17 1/2	3	0	7 1/4	4.4	7/16

BASEPLATE DIMENSIONS											
Max NEMA Frame	Baseplate number	HA**	HB	HT Min	HD	HE	HF	HG Max	HH	HL	HP
184T	139	12/15	39	3.5	9	4.5	36.5	3.75	0.75	4.5	1 1/4
256T	148	15/18	48	3.5	10.5	6	45.5	4.13	0.75	4.5	1 1/4
326TS	153	18/21	53	3.5	12.88	7.5	50.5	4.75	0.75	4.5	1 1/4

medium & large
PUMP END &
BASEPLATE

PUMP END DIMENSIONS												
	Pump Size	ANSI Designation	Discharge	Suction	D	X	CP	E1	E2	F	Impeller Eye (sq in)	Max.Diam Solids
MEDIUM	3 x 2 - 8	A60	2	3	8 1/4	9 1/2	23 1/2	4 7/8	3 5/8	12 1/2	5.4	1/2
	4 x 3 - 8	A70	3	4	8 1/4	11	23 1/2	4 7/8	3 5/8	12 1/2	12.5	1 1/8
	4 x 3 - 8G	A70	3	4	8 1/4	11	23 1/2	4 7/8	3 5/8	12 1/2	11.0	11/16
MEDIUM OR LARGE <small>(LF 3 x 1-1/2 - 13 available with large frame only)</small>	2 x 1 - 10	A05	1	2	8 1/4	8 1/2	23 1/2	4 7/8	3 5/8	12 1/2	4.9	7/16
	LF 2 x 1 - 10	A05	1	2	8 1/4	8 1/2	23 1/2	4 7/8	3 5/8	12 1/2	4.9	3/16
	3 x 1-1/2 - 10	A50	1 1/2	3	8 1/4	8 1/2	23 1/2	4 7/8	3 5/8	12 1/2	6.5	7/32
	3 x 2 - 10	A60	2	3	8 1/4	9 1/2	23 1/2	4 7/8	3 5/8	12 1/2	3.1	3/8
	4 x 3 - 10	A70	3	4	8 1/4	11	23 1/2	4 7/8	3 5/8	12 1/2	12.5	5/8
	6 x 4 - 10G	A80	4	6	10	13 1/2	23 1/2	4 7/8	3 5/8	12 1/2	25.9	1
	6 x 4 - 10H	A80	4	6	10	13 1/2	23 1/2	4 7/8	3 5/8	12 1/2	27.1	1
	3 x 1-1/2 - 13	A20	1 1/2	3	10	10 1/2	23 1/2	4 7/8	3 5/8	12 1/2	4.9	7/32
	LF 3 x 1-1/2 - 13	A20	1 1/2	3	10	10 1/2	23 1/2	4 7/8	3 5/8	12 1/2	8.3	7/16
	3 x 2 - 13	A30	2	3	10	11 1/2	23 1/2	4 7/8	3 5/8	12 1/2	3.1	3/8
4 x 3 - 13	A40	3	4	10	12 1/2	23 1/2	4 7/8	3 5/8	12 1/2	14.2	5/8	
6 x 4 - 13	A80	4	6	10	13 1/2	23 1/2	4 7/8	3 5/8	12 1/2	28.0	1	

BASEPLATE DIMENSIONS												
Max NEMA Frame	Baseplate number	HA**	HB	HT Min	If pump D = 8.25 HD	If pump D = 10 HD	HE	HF	HG Max	HH	HL	HP
184T	245	12/15	45	3.5	12	13.75	4.5	42.5	3.75	0.75	4.5	1 1/4
215T	252	15/18	52	3.5	12.38	14.13	6	49.5	4.13	0.75	4.5	1 1/4
286T	258	18/21	58	3.5	13	14.75	7.5	55.5	4.75	1	4.5	1 1/4
365T	264	18/21	64	3.5	13.88	14.75	7.5	61.5	4.75	1	4.5	1 1/4
405TS	268	24/26	68	3.5	14.88	14.88	9.5	65.5	4.75	1	4.5	1 1/4
449TS	280	24/26	80	3.5	15.88	15.88	9.5	77.5	4.75	1	4.5	1 1/4

* Flange drilling is standard ANSI 150 lb, flat face. All LF pumps use 150 lb raised face flanges, except the LF 3 x 1-1/2 - 13, which uses 300 lb raised face flanges.

** HA dimensions represent Griswold's standard construction/ANSI maximum width, respectively.

HP & CASTING DATA

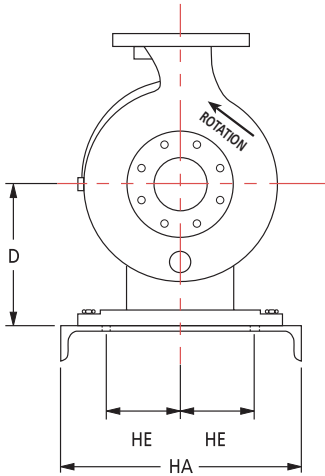

x-large PUMP END & BASEPLATE

PUMP END DIMENSIONS												
	Pump Size	ANSI Designation	Discharge	Suction	D	X	CP	E1	E2	F	Impeller Eye (sq in)	Max. Diam Solids
X-LARGE	8 x 6 - 13	A90	6	8	14 1/2	16	33 7/8	8	4.5	18 3/4	45.5	11/16
	10 x 8 - 13	A100	8	10	14 1/2	18	33 7/8	8	4.5	18 3/4	56.7	1
	8 x 6 - 15	A110	6	8	14 1/2	18	33 7/8	8	4.5	18 3/4	50.0	13/16
	10 x 8 - 15	A120	8	10	14 1/2	19	33 7/8	8	4.5	18 3/4	74.6	1 1/8
	10 x 8 - 15G	A120	8	10	14 1/2	19	33 7/8	8	4.5	18 3/4	63.0	1 1/8

BASEPLATE DIMENSIONS											
Max NEMA Frame	Baseplate number	HA**	HB	HT Min	HD	HE	HF	HG Max	HH	HL	HP
286T	368	24/26	68	5	19.25	9.5	65.5	4.75	1	6.5	1 1/4
405T	380	24/26	80	5	19.25	9.5	77.5	4.75	1	6.5	1 1/4
449T	398	24/26	98	5	19.25	9.5	95.5	4.75	1	6.5	1 1/4

* Flange drilling is standard ANSI 150 lb, flat face.

** HA dimensions represent Griswold's standard construction/ANSI maximum width, respectively.

tapped openings (NPT)

PURPOSE	NUMBER OF TAPS	TAP SIZE			
		811S	811M	811L	811XL
Lantern Ring Connection*	2	1/4	3/8	3/8	3/8
Frame Adapter Drain*	1		SLOT	SLOT	SLOT
Casing Drain**	1	3/8	3/8	3/8	RTF
Alternate Casing Drain	1	1/2	1/2	1/2	1/2
Bearing Frame Cooling*	2	1/2 & 1	1/2 & 1	1/2 & 1	1/2 & 1
Discharge Gage Connection**	1	1/4	3/8	3/8	3/8
Suction Gage Connection	1	1/4	3/8	3/8	3/8
Stuffing Box Circulating Line**	1	1/4	3/8	3/8	3/8
Quench Gland Connection*	2	1/4	1/4	1/4	1/4

* Indicates items furnished standard.

** Standard in Ductile Iron and Stainless Steel; optional in other materials.

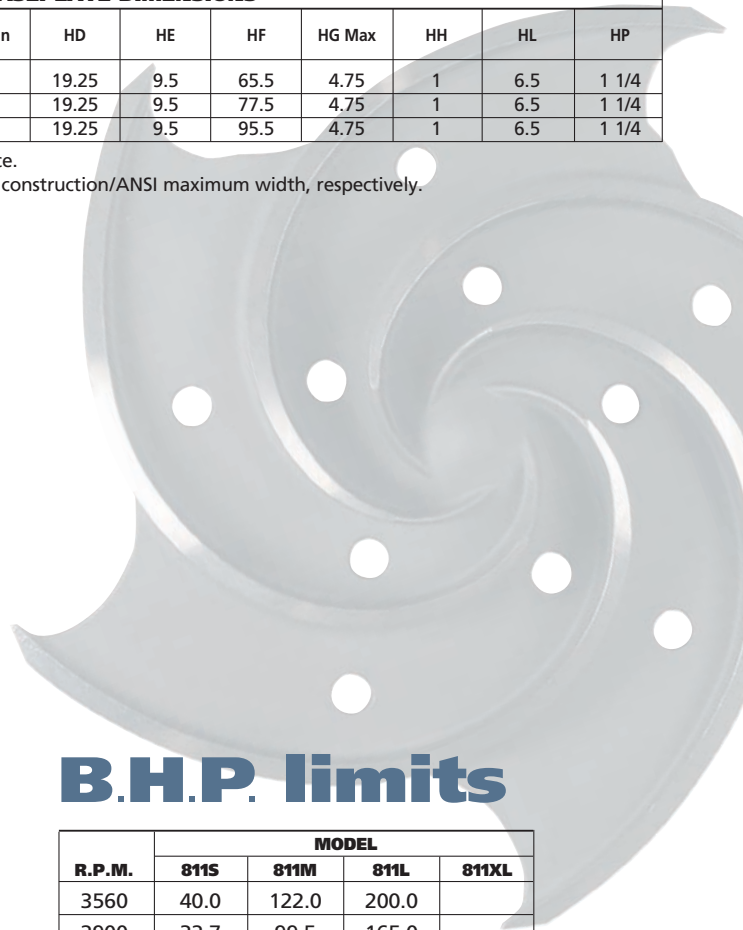

B.H.P. limits

R.P.M.	MODEL			
	811S	811M	811L	811XL
3560	40.0	122.0	200.0	
2900	32.7	99.5	165.0	
1780	20.0	61.0	100.0	249.0
1450	16.3	49.7	81.5	203.0
1180	13.3	40.5	66.4	165.0
880	9.9	30.2	49.5	123.0

materials/casting specs

DASH	MATERIAL	CASTING SPECIFICATION
N6	Ductile Iron	ASTM A395 Grade 60-40-18
91	316SS	ASTM A351 Grade CF8M
20	Alloy 20	ASTM A351 Grade CN-7M
X4	Duplex	ASTM A351 Grade CD4MCu



GRISWOLD™ 811
A **DOVER** COMPANY

GRISWOLD™
A **DOVER** COMPANY

22069 Van Buren Street • Grand Terrace, CA 92313-5607
Phone: (229) 226-5255 • (800) 843-9222
Fax (229) 226-5567 • (909) 422-1787
email: griswold@griswoldpump.com
website: www.griswoldpump.com

GRISWOLD
MEMBER OF
PSG™
PUMP SOLUTIONS GROUP
A **DOVER** COMPANY

Your Distributor: