



# e-HM/e-HME Series 60 Hz

THREADED HORIZONTAL MULTISTAGE CENTRIFUGAL ELECTRIC PUMPS

### CONTENTS

#### e-HM

Rating Plate .....2

e-HM Hydraulic Coverage Curve .....3

Applications, Benefits and Industry .....4

General Introduction .....5

General Characteristics ..... 6,7, 9

Markets / Applications / Specifications .....8

e-HM Identification code .....10

1, 3, 5 HM Models (Compact Design),  
Cross Section and Main Components .....11

1, 3, 5, 10, 15, 22 HM Models (Sleeve Design),  
Cross Section and Main Components .....12

e-HM Mechanical Seals .....13

Motor Data .....14

e-HM 3500 Performance Curves, Dimensions  
and Weights .....15-32

#### e-HME

Rating Plate .....33

Savings / Flexibility / Applications / Specifications ...33

Intelligent Control .....34

e-HME Hydraulic Coverage Curve .....35

e-HME Identification code .....36

Terminal Block .....37

How To Read Smart Pump Series Curves .....38

Performance Tables. ....39

Electrical Data Tables .....41

Dimensions and Weights.....42

1, 3, 5 HME Models (Compact Design),  
Cross Section and Main Components .....43

10, 15 HME Models (Sleeve Design),  
Cross Section and Main Components .....60

Technical Data .....67-69

Intellitronic X .....70

### e-HM RATING PLATE

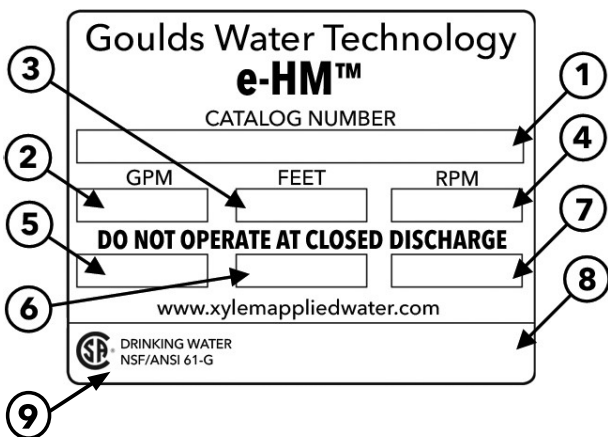

1	Goolds Water Technology Catalog Number
2	Capacity Range
3	TDH Range
4	Rated Speed
5	Rated Horsepower
6	Maximum Operating Pressure
7	Maximum Fluid Temperature
8	Pump Serial Number
9	Certifications Where Applicable

### e-HM™ Series Hydraulic Coverage Curve

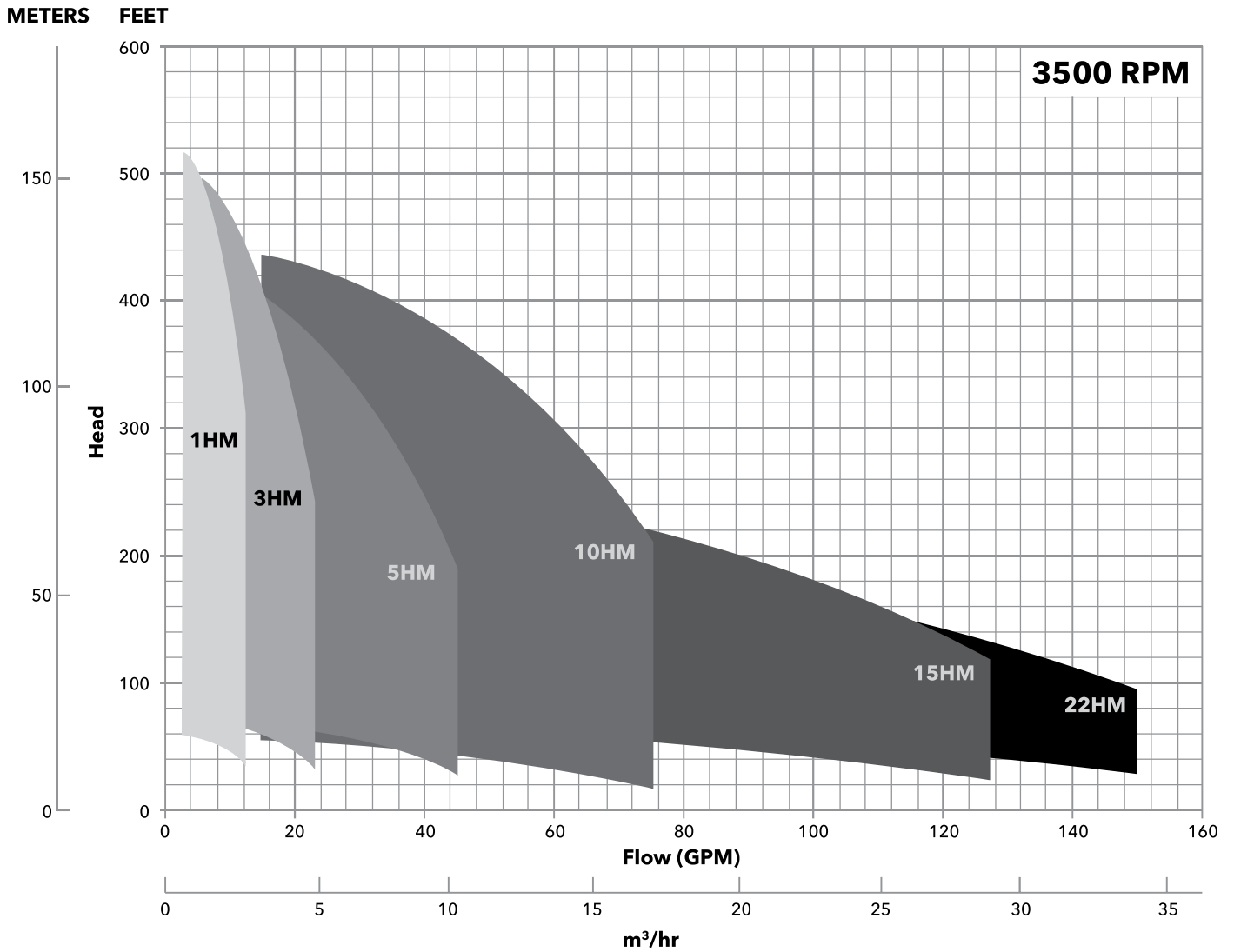

### **e-HM™ SERIES** **Applications, Benefits and Industry**

Whether you're in the market for industry specific applications, building services, or residential applications, the e-HM is designed to meet your water needs. Customizable options mean you get exactly the right pump for your application, exactly when you need it.



#### **APPLICATIONS**

Designed with compactness in mind, the e-HM is ideal for applications where a smaller footprint is needed. Ideal for use in pressure boosting and water supply systems, industrial washing and cleaning, water treatment, or circulation of hot and cold liquids in cooling and conditioning systems. The broad coverage and range of applications make this pump an ideal solution in industry, building services and residential applications.

#### **BENEFITS**

**Reliability:** The e-HM series was designed to withstand heavy-duty applications in Industry. Made of 316 stainless steel and construction incorporating a 20% increase in the pump body thickness, ensures enhanced durability and reliability.

**Versatility:** Offering two different mechanical configurations, 7 mechanical seal options, high-efficiency motors, and surface treatment options such as electropolishing and passivation, make the e-HM suitable for multiple applications.

**Performances:** The e-HM series provides best-in-class efficiency and is up to 72% efficient. Compared to similar pumps in the market, the e-HM offers a potential of 30% in energy savings versus the competition.

**Global Platform:** Assembled in different factories around the world, the e-HM can offer easier accessibility due to its proximity to our customers. Beyond our commitment to reduce the carbon footprint of e-HM, this global platform offers the same design which is available everywhere using the same quality processes.

#### **FEATURES**

- Wide range of performances with 6 sizes, flow up to 127 gpm, heads up to 525 feet
- Maximum working pressure up to 230 psi (16 bar)
- Premium efficient, UL Recognized (cURus) motor
- 90% of the range has the same suction height (3.54") for easy installation or system upgrades

## Commercial Water

### e-HM™ SERIES GENERAL INTRODUCTION

Our newly redesigned horizontal multi-stage high pressure centrifugal pump offers outstanding efficiencies. The high-efficiency motor coupled with an innovative hydraulic design, NPT threaded inlet and outlet connections, and broad coverage provides flexible options for a variety of applications. Whether you're in the market for industry specific applications, building services, or residential applications, the e-HM is designed to meet your needs.

#### Pump Design

The e-HM is a close-coupled horizontal multi-stage design with NPT threaded inlet and outlet connections, and TEFC equivalent high-efficiency motors. The pump incorporates an innovative hydraulic design that provides the highest efficiency in the market today.

The e-HM is available in two configurations:

##### Compact Design

Sizes 1HM, 3HM, and 5HM

- 1HM and 3HM up to 6 stages
- 5HM up to 5 stages

##### Sleeve Design

Sizes 1HM, 3HM, 5HM, 10HM, 15HM and 22HM

- 1HM & 3HM start at 7 stages
- 5HM starts at 6 stages

The compact design is made of one single piece of fabricated stainless steel for the pump body which is directly connected to the motor flange. The sleeve design is made of an external stainless steel TIG welded sleeve, and incorporates a separate suction housing. All available in 316 stainless steel construction consisting of a 20% increase in pump body thickness for enhanced durability and reliability.

#### Motor

The e-HM series incorporates a UL Recognized (cURus) premium efficiency, inverter design motor for additional energy savings and versatility. The standard motor enclosure is a TEFC (IP55) design which can be paired with Goulds Water Technology variable speed drives.

#### EISA Compliance

Xylem conforms to the requirements of the Energy Independence and Security Act (EISA) of 2007. Under the Energy Independence and Security Act of 2007 (EISA), covered motors that are manufactured or imported for distribution in commerce in the United States on or after December 19, 2010, must comply with the applicable EISA energy conservation standards. EISA-covered motors include general purpose electric motors (subtype I), general purpose electric motors (subtype II), fire pump motors, and NEMA Design B general purpose electric motors, which are manufactured alone or as a component of another piece of equipment. The standards are found in sections 431.25(c)-(f) of Title 10 of the Code of Federal Regulations, Part 431 (10 CFR Part 431).



### e-HM™ SERIES GENERAL CHARACTERISTICS

1HM, 3HM			
2-6 Stages		7+ stages	
t (F)	PSI	t (F)	PSI
-20	147	-20	235
248	147	248	235
248	147	248	235
248	147		
248	147	194	235
		194	235
194	147		

5HM			
2-5 Stages		7+ stages	
t (F)	PSI	t (F)	PSI
-20	147	-20	235
248	147	248	235
248	147	248	235
248	147		
248	147	194	235
		194	235
194	147		

10HM, 15HM, 22HM	
All Stages	
t (F)	PSI
-20	235
248	235
248	235
194	235
194	235
194	0

### ELECTRIC PUMP NOISE

Power	Noise
HP	LpA dB
0.75	55
1	55
1.5	60
2	60
3	60
4	60
5.5	60
7.5	60

The table shows the mean sound pressure (Lp) measured as per Curve A (Standard ISO 1680). Noise values were measured with the 50 Hz motor running idle with a tolerance of 3 dB (A).

### STORAGE AND TRANSPORT TEMPERATURE

-40°C to +60°C

### NEMA MG-1 TABLE 12-12 FL EFFICIENCIES FOR 60 HZ NEMA PREMIUM

HP	NEMA 2-Pole	Xylem 2-Pole
1	77	83.4
1½	84	85.6
2	85.5	87.2
3	86.5	87.7
5	88.5	91.0
7½	89.5	90.5
10	90.2	90.8
15	91	92.4
20	91	93.4
25	91.7	93.5
30	91.7	93.4
40	92.4	

## Commercial Water

### 1HM, 3HM PRESSURE AND TEMPERATURE LIMITS

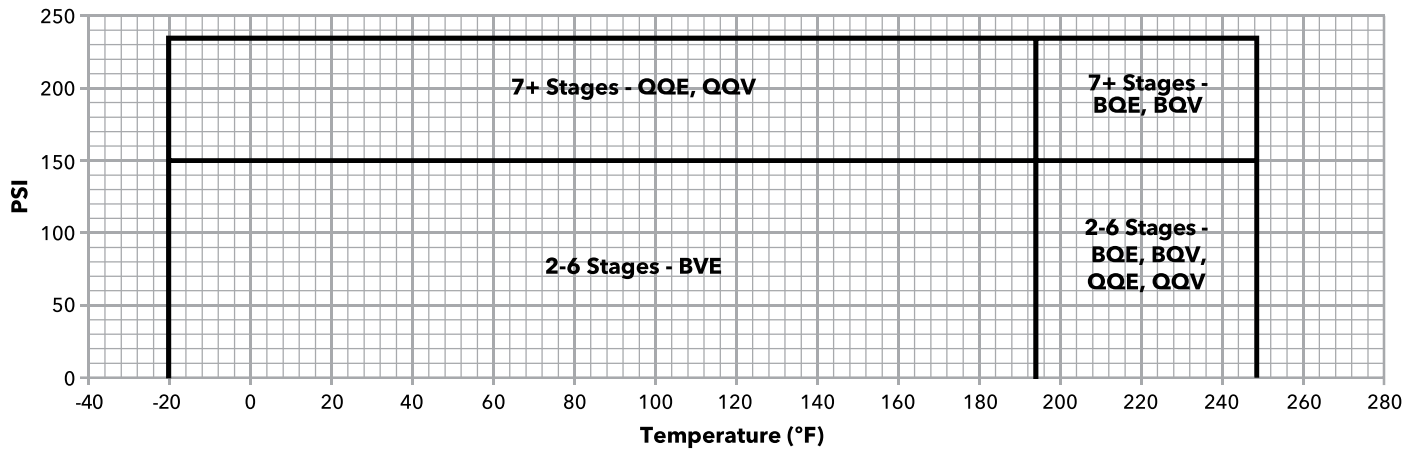

### 5HM PRESSURE AND TEMPERATURE LIMITS

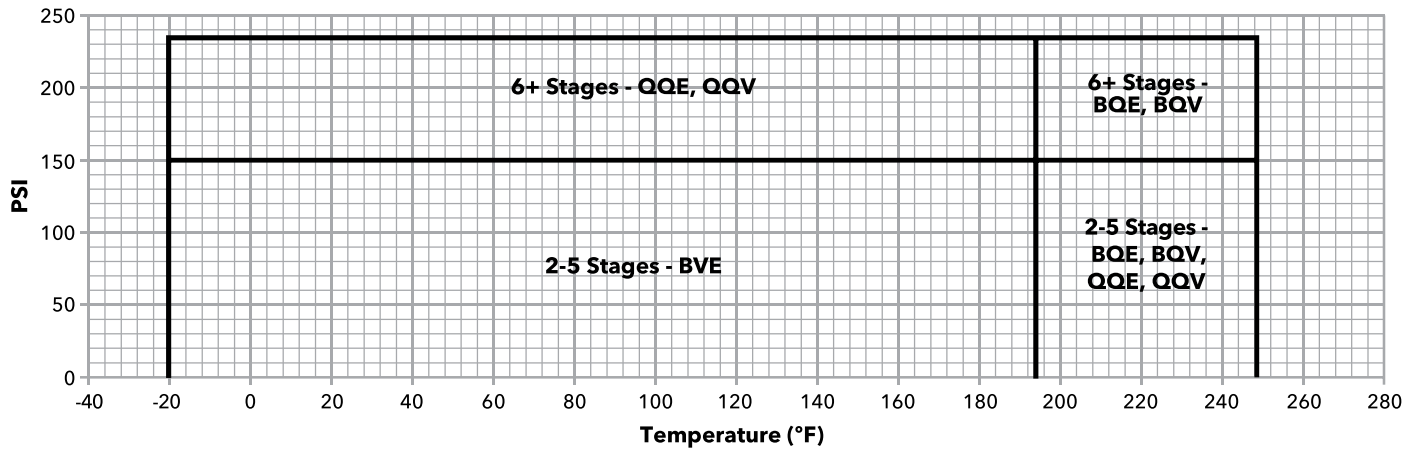

### 10HM, 15HM, 22HM PRESSURE AND TEMPERATURE LIMITS

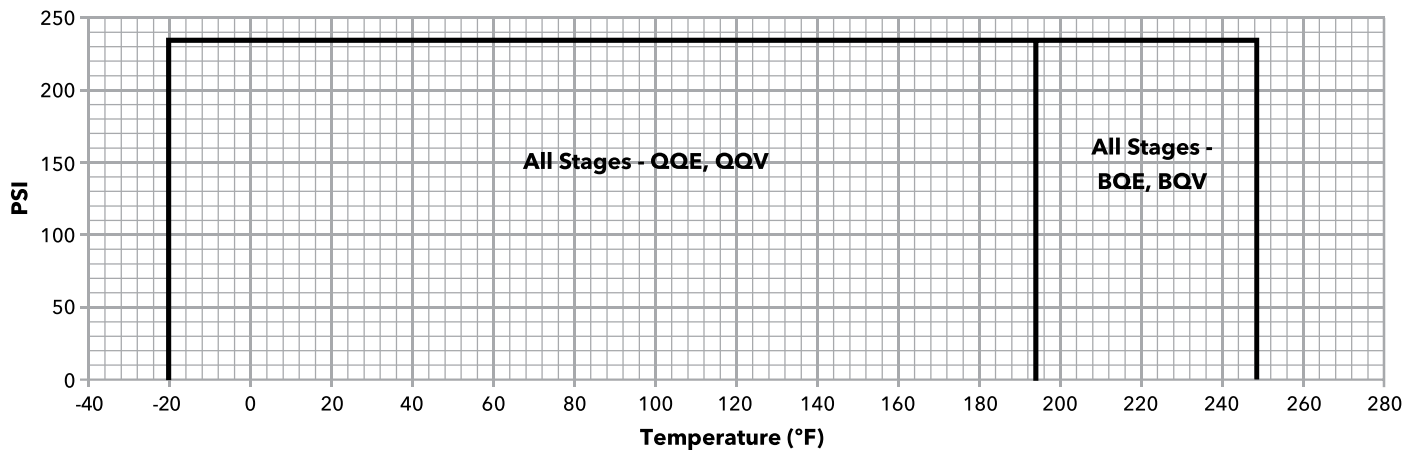

### e-HM™ SERIES

**High efficiency  
horizontal  
multistage pump**

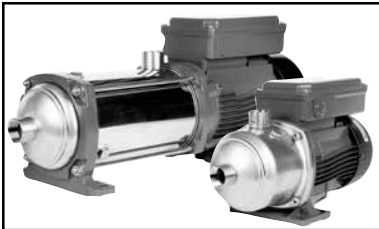

### MARKETS

BUILDING SERVICES.  
INDUSTRY.

### APPLICATIONS

- Pressure boosting and water supply systems.
- Washing and cleaning industry including vehicles washing.
- Circulation of hot and cold liquids for heating, cooling and conditioning systems.
- Water treatment applications.
- Handling of moderately aggressive liquids.
- Food and beverage industries.

### SPECIFICATIONS

#### Pump

- Flow rate: up to 127 GPM
- Heads: up to 525 feet
- Designs:
  - Compact - one piece pump body
    - 1HM and 3HM, sizes up to 6 stages
    - 5HM, sizes up to 5 stages
  - Sleeve - Sleeve and separate suction housing
    - 1HM and 3HM, 7 stages and above
    - 5 HM, 6 stages and above
    - All 10HM, 15HM, and 22HM sizes
- Connections: NPT threaded suction and discharge
- Temperature of the pumped liquid: -20°F to 248°F ( -30°C to 120°C )
- Ambient Temperature:
  - Standard Offering: -15°C to 40°C
  - Available Options: Single Phase: -15°C to 45°C
  - Three Phase: -15°C to 50°C
- Maximum Operating Pressure:
  - Compact pump designs - 145 PSI
  - Sleeve pump designs - 230 PSI

#### Motor

- Premium Efficiency
- TEFC (IP55) design
- cURus\*
- 3500 RPM
- Class F insulation
- Standard voltage:
  - Single Phase: 115 or 230V, 60 Hz - built in auto reset overload protection
  - Three Phase: 208-230/460V, 50 or 60 Hz; or 575V, 60 Hz

\* cURus applies to 60 Hz frequency

### AGENCY LISTING FOR e-HM CONFIGURATIONS

Single-phase up to 2 HP and three-phase models up to 3 HP.



Tested to UL778 CAN 22.2 by CSA International  
(Canadian Standards Association).



## Commercial Water

### e-HM™ SERIES GENERAL CHARACTERISTICS



**Compact**



**Sleeve**

HM Series	1HM	3HM	5HM	10HM	15HM	22HM
Nominal Flow ( GPM )	10	16	33	56	90	100
Flow Range ( GPM )	3 - 12	5-23	10 - 45	15 - 75	25 - 127	30 - 150
Number of Stages	2 - 18	2 - 14	2 - 12	1 - 8	1 - 4	1 - 3
Maximum Head ( Ft )	520	500	430	450	275	217
Maximum Working Pressure	145 psi - Compact pumps 230 psi - Sleeve pumps					
Temperature Range ( °F )	-20°F to 248°F (-30°C to 120°C )					
Maximum Pump Efficiency ( % )	51	60	70	70	70	68
HP Range	3/4 - 2	3/4 - 3	3/4 - 4	1 - 7 1/2	2 - 7 1/2	3 - 7 1/2
Piping Connections (NPT)	1" x 1"	1" x 1"	1 1/4" x 1"	1 1/2" x 1 1/4"	2" x 1 1/2"	2" x 1 1/2"

### OPTIONAL FEATURES:

- Special Voltages
- 50 Hz Frequency
- Suitable for use with VFDs (Aquavar® CPC and IPC). Other options include e-HME smart pump range (see page 42).

### e-HM PRODUCT LINE NUMBERING SYSTEM FOR 1-22HM PUMPS

The various versions of the e-HM line are identified by a product code number on the pump label. This number is also the catalog number for the pump. The meaning of each digit in the product code number is shown below.

Note: Not all combinations are possible.

#### Example Product Code

15    HM    04    N    55    T    6P    BQE    H

#### Special Configuration

H = Single Phase pump label 45°C ambient  
H = Three Phase pump label 50°C ambient

#### Seal Material

BQE = Carbon-SilCar-EPDM (standard)  
BQV = Carbon-SilCar-Viton  
QQE = SilCar-SilCar-EPDM  
QQV = SilCar-SilCar-Viton  
BVE = Carbon-Ceramic-EPDM  
QQK = SilCar-SilCar-Kalrez  
BQK = Carbon-SilCar-Kalrez

#### Hz - Phase - Voltage

6F = 60 - 1 - 230V  
6B = 60 - 1 - 115V  
6P = 60 - 3 - 208-230/460V; 50 - 3 - 220-240/380-415V\*  
6Z = 60 - 3 - 575V  
5H = 50 - 1 - 220-240V  
5D = 50 - 1 - 110-120V

#### Phase

M = 1 PH            T = 3 PH

#### HP Rating

05 = .75 hp        22 = 3 hp  
07 = 1 hp         30 = 4 hp  
11 = 1.5 hp       40 = 5.5 hp  
15 = 2 hp         55 = 7.5 hp

#### Pump Construction

N = 316 Stainless Steel

#### Total Number of Stages

#### Product Line

HM = Stainless Horizontal Multi-stage

#### Nominal Flow

1 = 5 GPM        10 = 56 GPM  
3 = 16 GPM       15 = 90 GPM  
5 = 33 GPM       22 = 100 GPM

\* For CE compliant 50 Hz motors, please contact the factory

### MODEL 1, 3, 5 HM..N SERIES - MAJOR COMPONENTS

#### (COMPACT DESIGN)

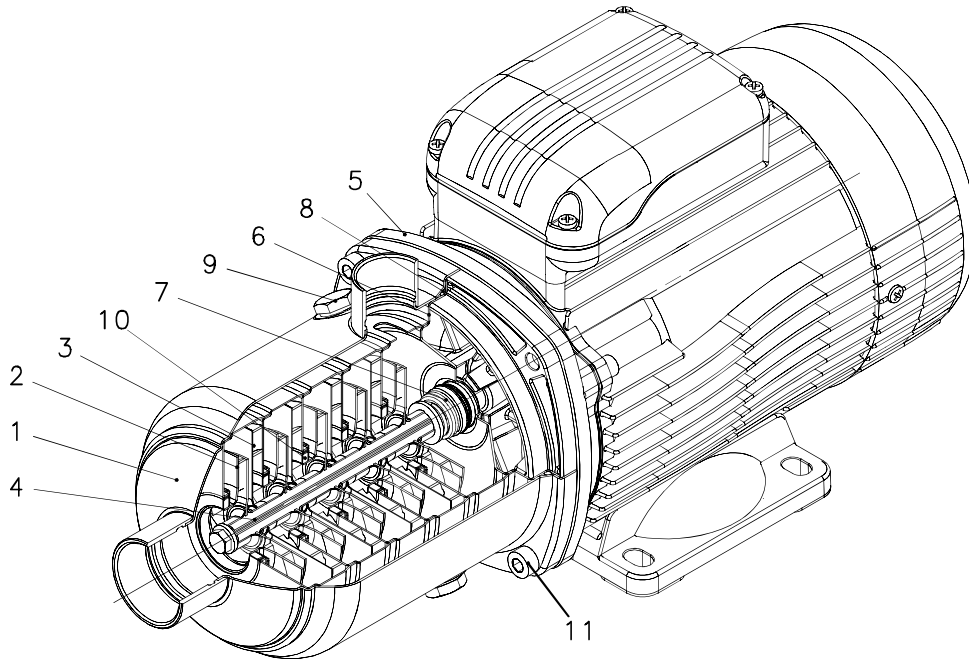

#### TABLE OF MATERIALS HM..N SERIES

REFERENCE NUMBER	NAME	MATERIAL	REFERENCE STANDARDS	
			USA	EUROPE
1	Pump body	Stainless steel	AISI 316L	EN 10088-1-X2CrNiMo17-12-2 (1.4404)
2	Impeller	Stainless steel	AISI 316L	EN 10088-1-X2CrNiMo17-12-2 (1.4404)
3	Diffuser	Stainless steel	AISI 316L	EN 10088-1-X2CrNiMo17-12-2 (1.4404)
4	Shaft	Stainless steel	AISI 316	EN 10088-1-X5CrNiMo17-12-2 (1.4401)
5	Adapter	Aluminium	-	EN 1706-AC-AISI11Cu2 (Fe) (AC46100)
6	Seal housing	Stainless steel	AISI 316L	EN 10088-1-X2CrNiMo17-12-2 (1.4404)
7	Mechanical seal	Ceramic / Carbon / EPDM		
8	Elastomers	EPDM		
9	Fill / drain plugs	Stainless steel	AISI 316	EN 10088-1-X5CrNiMo17-12-2 (1.4401)
10	Wear ring	Technopolymer (PPS)		
11	Bolts and screws	Stainless steel	AISI 304	EN 10088-1-X5CrNi18-10 (1.4301)

### MODEL 1, 3, 5, 10, 15, 22 HM..N SERIES - MAJOR COMPONENTS

#### (SLEEVE DESIGN)

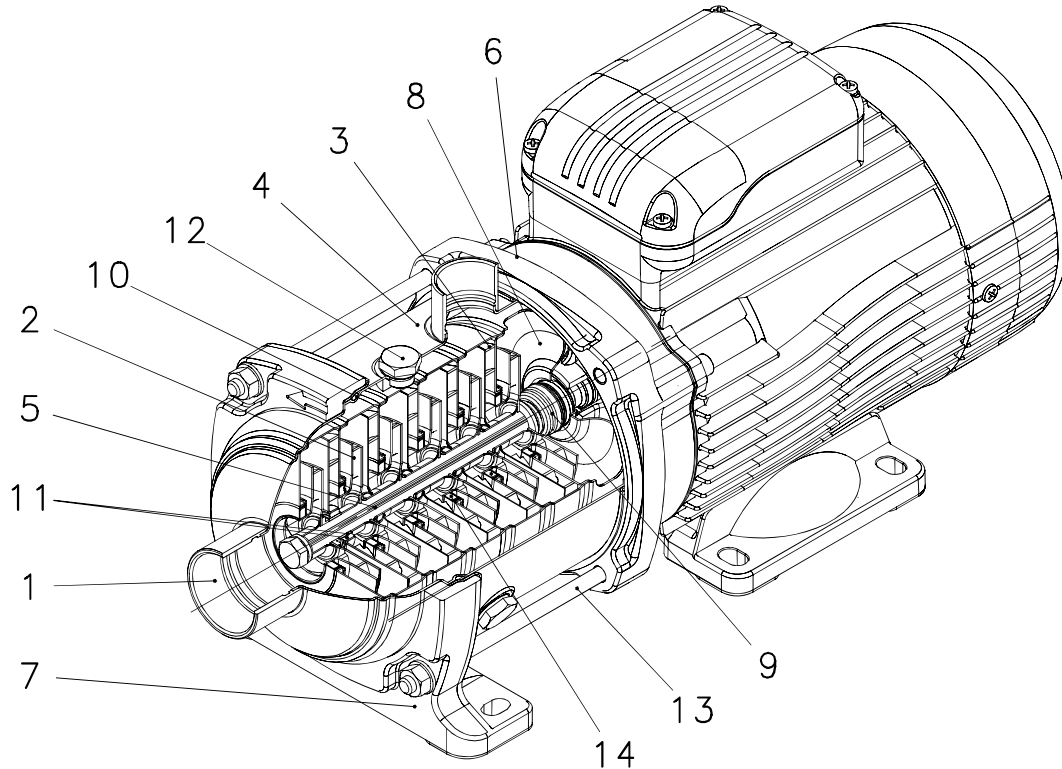

#### TABLE OF MATERIALS HM..N SERIES

REFERENCE NUMBER	NAME	MATERIAL	REFERENCE STANDARDS	
			USA	EUROPE
1	Head	Stainless steel	AISI 316L	EN 10088-1-X2CrNiMo17-12-2 (1.4404)
2	Impeller	Stainless steel	AISI 316L	EN 10088-1-X2CrNiMo17-12-2 (1.4404)
3	Diffuser and upper spacer	Stainless steel	AISI 316L	EN 10088-1-X2CrNiMo17-12-2 (1.4404)
4	Outer sleeve	Stainless steel	AISI 316L	EN 10088-1-X2CrNiMo17-12-2 (1.4404)
5	Shaft	Stainless steel	AISI 316	EN 10088-1-X5CrNiMo17-12-2 (1.4401)
6	Adapter	Aluminium	-	EN 1706-AC-AISI11Cu2 (Fe) (AC46100)
7	Ring with foot	Aluminium	-	EN 1706-AC-AISI11Cu2 (Fe) (AC46100)
8	Seal housing	Stainless steel	AISI 316L	EN 10088-1-X2CrNiMo17-12-2 (1.4404)
9	Mechanical seal	Ceramic / Carbon / EPDM (PN10) - Silicon Carbide/Carbon/EPDM (PN16)		
10	Elastomers	EPDM		
11	Shaft sleeve and bushing	Tungsten carbide		
12	Fill / drain plugs	Stainless steel	AISI 316L	EN 10088-1-X5CrNiMo17-12-2 (1.4401)
13	Tie rods	Stainless steel	AISI 431	EN 10088-1-X17CrNi16-2 (1.4057)
14	Wear ring	Technopolymer (PPS)		

### e-HM™ SERIES MECHANICAL SEALS

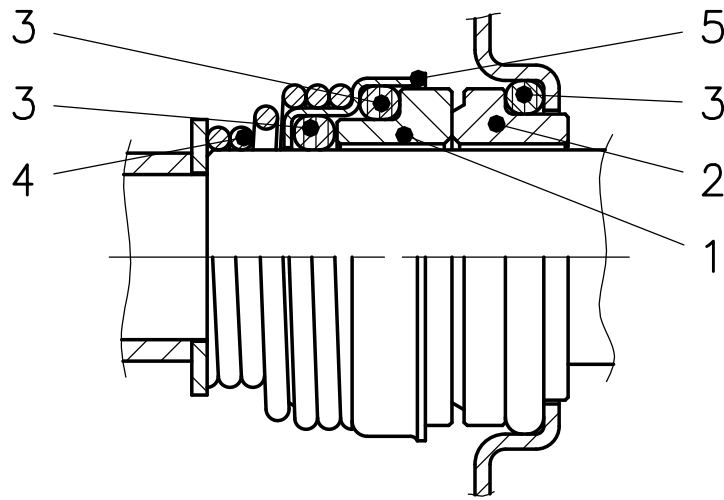

### LIST OF MATERIALS

Components	Part Number			
	1	2	3	4 and 5
	Rotory Face	Stationary Face	Elastomers	Hardware
Materials	B - Carbon		E - EPDM (EPR)	All 316 SS
	Q - Sil Carbide		V - Viton	
	V - Ceramic			

### PRESSURE AND TEMPERATURES LIMITS

Seal Code	1HM, 3HM		5HM		10HM, 15HM, 22HM
	2-6 Stages	7+ Stages	2-5 Stages	6+ Stages	All Stages
BQE	147PSI at 248F	235PSI at 248F	147PSI at 248F	235PSI at 248F	235PSI at 248F
BQV	147PSI at 248F	235PSI at 248F	147PSI at 248F	235PSI at 248F	235PSI at 248F
QQE	147PSI at 248F	235PSI at 194F	147PSI at 248F	235PSI at 194F	235PSI at 194F
QQV	147PSI at 248F	235PSI at 194F	147PSI at 248F	235PSI at 194F	235PSI at 194F
BVE	147PSI at 194F	Not Available	147PSI at 194F	Not Available	Not Available

## Commercial Water

### MOTOR DATA

#### 3500 RPM, 60Hz, Xylem Motors

HP	Ph	Volts	Enclosure	SF	FL Amps	SF Amps	Frame Size	Motor Flange Type	GWT P/N
3/4	1	115	TEFC / IP55	1.0	8.07	N/A	71	COMPACT 1-3-5 EHM	107236000
1.0	1	115	TEFC / IP55	1.0	10.3	N/A	71	COMPACT 1-3-5 EHM	107236040
								SLEEVE 1-3-5 EHM	107236050
3/4	1	230	TEFC / IP55	1.0	3.69	N/A	71	COMPACT 1-3-5 EHM	107236010
1.0	1	230	TEFC / IP55	1.0	4.84	N/A	71	COMPACT 1-3-5 EHM	107236060
								SLEEVE 1-3-5 EHM	107236070
1.5	1	230	TEFC / IP55	1.0	6.85	N/A	80	SLEEVE 10-15-22 EHM	107236100
								COMPACT 1-3-5 EHM	107236110
								SLEEVE 10-15-22 EHM	107236130
2.0	1	230	TEFC / IP55	1.0	9.22	N/A	80	SLEEVE 1-3-5 EHM	107236160
								SLEEVE 10-15-22 EHM	107236170
3/4	3	208-230/460	TEFC / IP55	1.15	2.61-2.64/1.32	2.87	71	COMPACT 1-3-5 EHM	107236020
1.0	3	208-230/460	TEFC / IP55	1.15	3.09-3.02/1.51	3.46	80	COMPACT 1-3-5 EHM	107236180
								SLEEVE 1-3-5 EHM	107236190
1.5	3	208-230/460	TEFC / IP55	1.15	4.35-4.24/2.12	4.89	80	SLEEVE 10-15-22 EHM	107236200
								COMPACT 1-3-5 EHM	107236240
2.0	3	208-230/460	TEFC / IP55	1.15	5.77-5.58/2.79	6.51	80	SLEEVE 1-3-5 EHM	107236250
								COMPACT 1-3-5 EHM	107236280
3.0	3	208-230/460	TEFC / IP55	1.15	8.23-7.98/3.99	9.33	90	SLEEVE 1-3-5 EHM	107236290
								SLEEVE 10-15-22 EHM	107236300
4.0	3	208-230/460	TEFC / IP55	1.15	11.3-10.9/5.45	12.8	90	SLEEVE 1-3-5 EHM	50A01R300H
								SLEEVE 10-15-22 EHM	50A01R500H
5.5	3	208-230/460	TEFC / IP55	1.15	14.1-13.4/6.7	16	100	SLEEVE 1-3-5 EHM	50A02R300H
								SLEEVE 10-15-22 EHM	50A02R500H
7.5	3	208-230/460	TEFC / IP55	1.15	18.7-17.8/8.91	21.4	112	SLEEVE 10-15-22 EHM	50A08R500H
3/4	3	575	TEFC / IP55	1.15	1.04	1.12	71	COMPACT 1-3-5 EHM	107236030
1.0	3	575	TEFC / IP55	1.15	1.20	1.31	80	COMPACT 1-3-5 EHM	107236210
								SLEEVE 1-3-5 EHM	107236220
1.5	3	575	TEFC / IP55	1.15	1.69	1.87	80	SLEEVE 10-15-22 EHM	107236230
								COMPACT 1-3-5 EHM	107236260
2.0	3	575	TEFC / IP55	1.15	2.2	2.44	80	SLEEVE 1-3-5 EHM	107236270
								COMPACT 1-3-5 EHM	107236310
3.0	3	575	TEFC / IP55	1.15	3.18	3.53	90	SLEEVE 10-15-22 EHM	107236320
								SLEEVE 1-3-5 EHM	107236330
4.0	3	575	TEFC / IP55	1.15	4.36	4.86	90	SLEEVE 1-3-5 EHM	50A01T300H
								SLEEVE 10-15-22 EHM	50A01T500H
5.5	3	575	TEFC / IP55	1.15	5.26	5.92	100	SLEEVE 1-3-5 EHM	50A02T300H
								SLEEVE 10-15-22 EHM	50A02T500H
7.5	3	575	TEFC / IP55	1.15	7.2	8.07	112	SLEEVE 10-15-22 EHM	50A08T500H
								SLEEVE 10-15-22 EHM	50A13T500H

Above data is for Xylem™ Motors. Specifications are subject to change.

## Commercial Water

### 1HM..N SERIES, (2 TO 10 STAGES) DIMENSIONS AND WEIGHTS AT 60 HZ, 3500 RPM

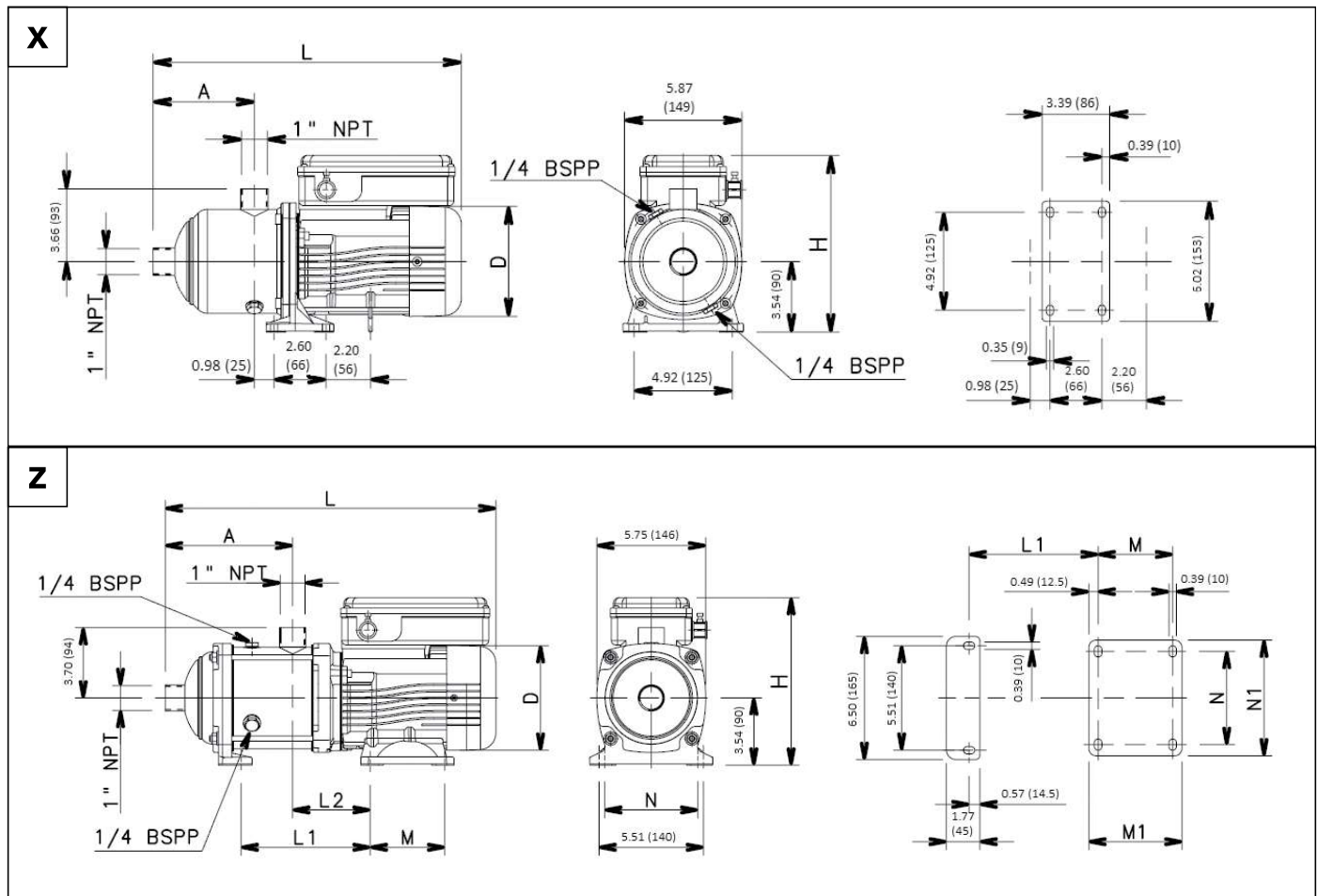

Pump Size Stages	Phase	DWG No.	Motor		Dimensions (in)										Max. Working Pressure (PSI)	Weight (lbs)
			HP	Frame Size	A	D	H	L	L1	L2	M	M1	N	N1		
1HM02	SINGLE PHASE	X	0.75	71	3.43	5.51	8.86	13.78	-	-	-	-	-	-	147	18
1HM03			0.75	71	3.43	5.51	8.86	13.78	-	-	-	-	-	-	147	18
1HM04			0.75	71	4.21	5.51	8.86	14.57	-	-	-	-	-	-	147	20
1HM05			0.75	71	5.00	5.51	8.86	15.35	-	-	-	-	-	-	147	20
1HM06			0.75	71	5.79	5.51	8.86	16.14	-	-	-	-	-	-	147	20
1HM07	SINGLE PHASE	Z	1	71	5.94	5.51	8.86	16.69	6.02	4.09	3.94	4.92	4.92	6.10	235	24
1HM08			1	71	6.73	5.51	8.86	17.48	6.81	4.09	3.94	4.92	4.92	6.10	235	26
1HM09			1	71	7.52	5.51	8.86	18.27	7.60	4.09	3.94	4.92	4.92	6.10	235	26
1HM10			1.5	80	8.31	6.10	9.13	20.79	8.39	4.09	3.94	4.92	4.92	6.10	235	35

1HM02	THREE PHASE	X	0.75	71	3.43	5.51	8.86	13.78	-	-	-	-	-	-	147	18
1HM03			0.75	71	3.43	5.51	8.86	13.78	-	-	-	-	-	-	147	18
1HM04			0.75	71	4.21	5.51	8.86	14.57	-	-	-	-	-	-	147	20
1HM05			0.75	71	5.00	5.51	8.86	15.35	-	-	-	-	-	-	147	20
1HM06			0.75	71	5.79	5.51	8.86	16.14	-	-	-	-	-	-	147	20
1HM07	THREE PHASE	Z	1	71	5.94	6.10	9.13	18.43	6.02	4.09	3.94	4.92	4.92	6.10	235	31
1HM08			1	71	6.73	6.10	9.13	19.21	6.81	4.09	3.94	4.92	4.92	6.10	235	33
1HM09			1	71	7.52	6.10	9.13	20.00	7.60	4.09	3.94	4.92	4.92	6.10	235	33
1HM10			1.5	80	8.31	6.10	9.13	20.79	8.39	4.09	3.94	4.92	4.92	6.10	235	35

### 1HM..N SERIES, (2 TO 10 STAGES) OPERATING CHARACTERISTICS AT 60 HZ, 3500 RPM

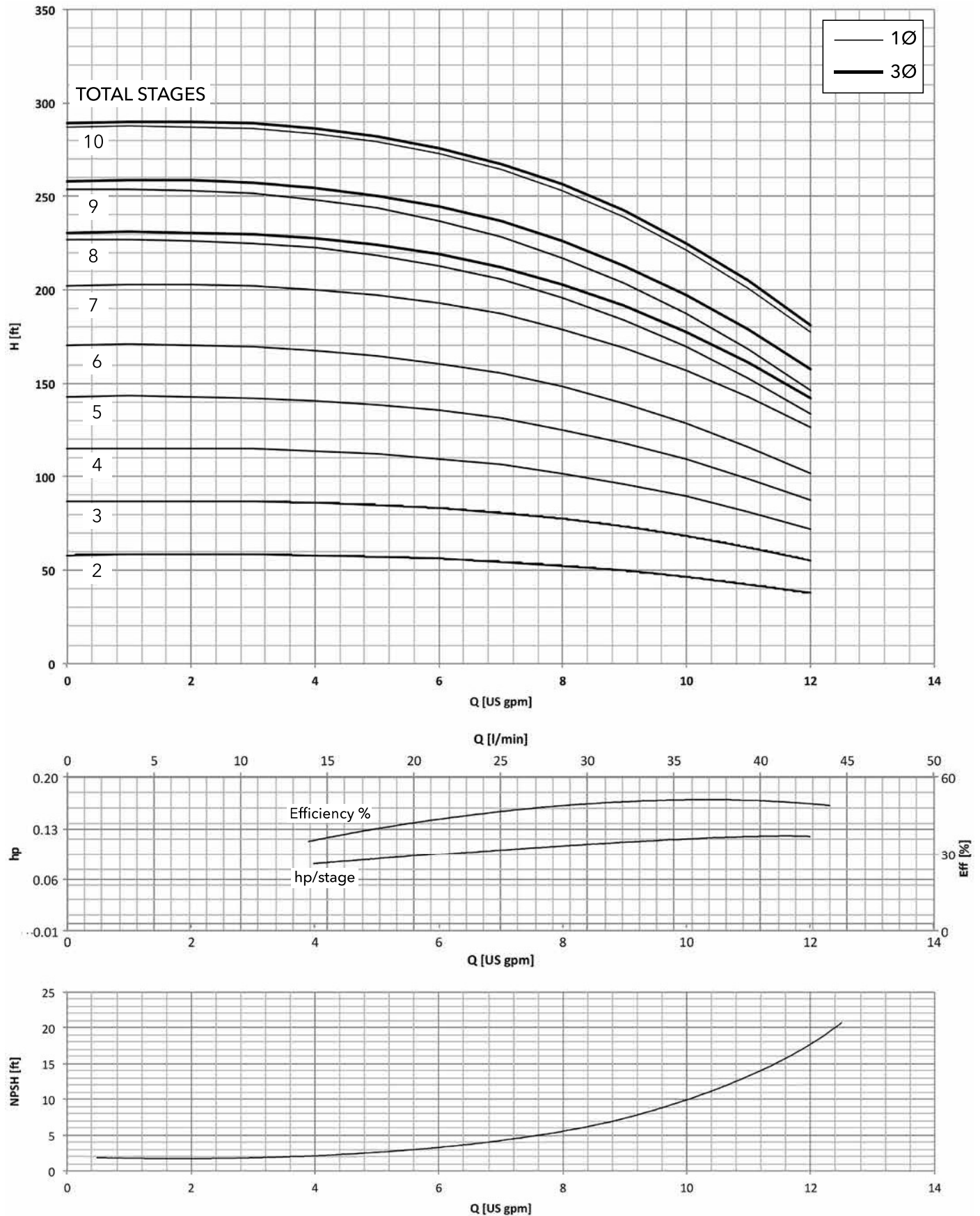

MINIMUM FLOW RATE: 3 GPM



## Commercial Water

### 1HM..N SERIES, (11 TO 18 STAGES) DIMENSIONS AND WEIGHTS AT 60 HZ, 3500 RPM

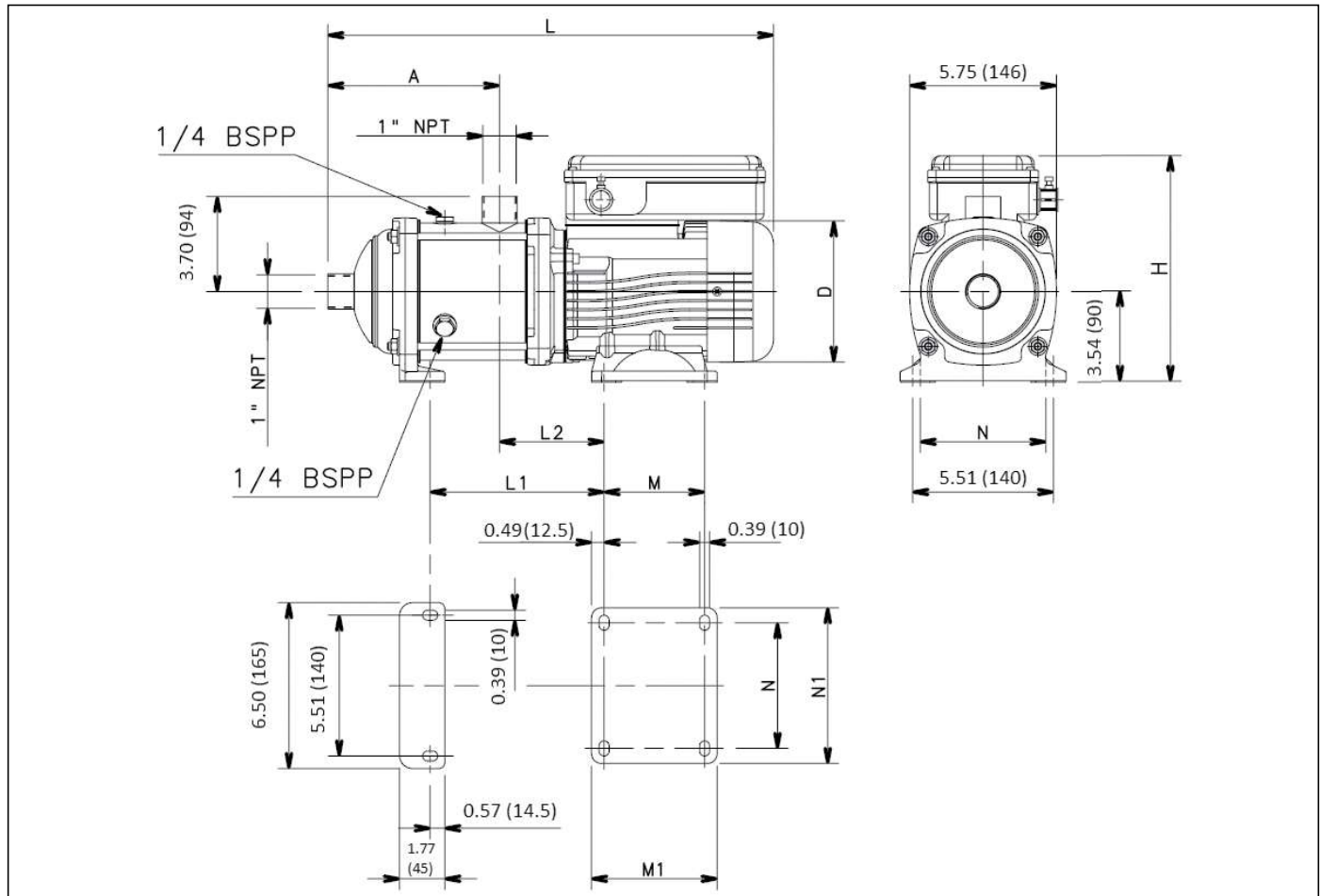

Pump Size Stages	Phase	Motor		Dimensions (in)										Max. Working Pressure (PSI)	Weight (lbs)
		HP	Frame Size	A	D	H	L	L1	L2	M	M1	N	N1		
1HM11	SINGLE PHASE	1.5	80	9.09	6.10	9.13	21.57	9.17	4.09	3.94	4.92	4.92	6.10	235	37
1HM12		1.5	80	9.88	6.10	9.13	22.36	9.96	4.09	3.94	4.92	4.92	6.10	235	37
1HM13		1.5	80	10.67	6.10	9.13	23.15	10.75	4.09	3.94	4.92	4.92	6.10	235	37
1HM14		2	80	11.46	6.10	9.13	23.94	11.54	4.09	3.94	4.92	4.92	6.10	235	42
1HM15		2	80	12.24	6.10	9.13	24.72	12.32	4.09	3.94	4.92	4.92	6.10	235	42
1HM16		2	80	13.03	6.10	9.13	25.51	13.11	4.09	3.94	4.92	4.92	6.10	235	42
1HM17		2	80	13.82	6.10	9.13	26.30	13.90	4.09	3.94	4.92	4.92	6.10	235	44
1HM18		2	80	14.61	6.10	9.13	27.09	14.69	4.09	3.94	4.92	4.92	6.10	235	44

1HM11	THREE PHASE	1.5	80	9.09	6.10	9.13	21.57	9.17	4.09	3.94	4.92	4.92	6.10	235	37
1HM12		1.5	80	9.88	6.10	9.13	22.36	9.96	4.09	3.94	4.92	4.92	6.10	235	37
1HM13		1.5	80	10.67	6.10	9.13	23.15	10.75	4.09	3.94	4.92	4.92	6.10	235	37
1HM14		2	80	11.46	6.10	9.13	23.94	11.54	4.09	3.94	4.92	4.92	6.10	235	42
1HM15		2	80	12.24	6.10	9.13	24.72	12.32	4.09	3.94	4.92	4.92	6.10	235	42
1HM16		2	80	13.03	6.10	9.13	25.51	13.11	4.09	3.94	4.92	4.92	6.10	235	42
1HM17		2	80	13.82	6.10	9.13	26.30	13.90	4.09	3.94	4.92	4.92	6.10	235	44
1HM18		2	80	14.61	6.10	9.13	27.09	14.69	4.09	3.94	4.92	4.92	6.10	235	44

### 1HM..N SERIES, (11 TO 18 STAGES) OPERATING CHARACTERISTICS AT 60 HZ, 3500 RPM

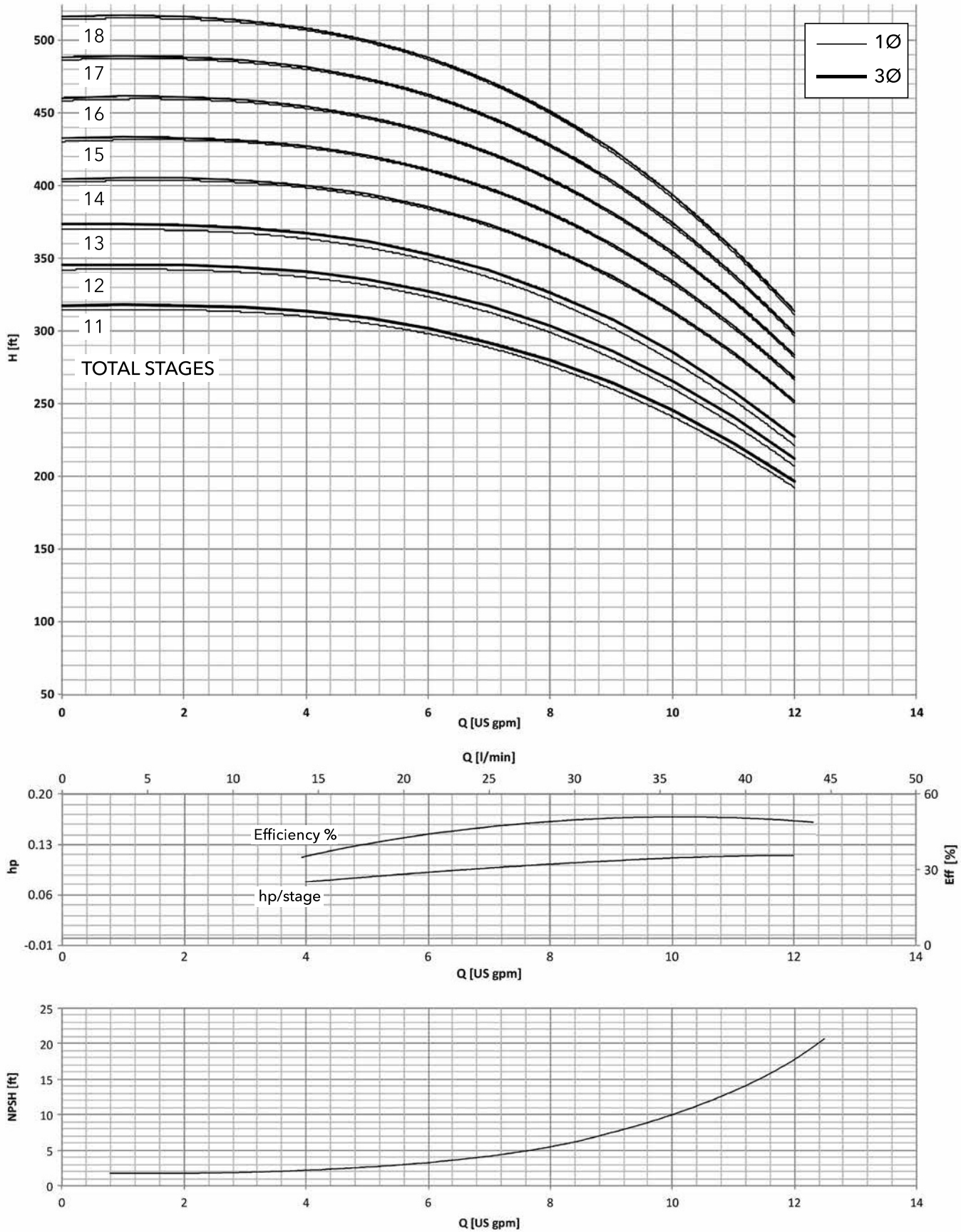

MINIMUM FLOW RATE: 3 GPM

## Commercial Water

### 3HM..N SERIES, (2 TO 8 STAGES) DIMENSIONS AND WEIGHTS AT 60 HZ, 3500 RPM

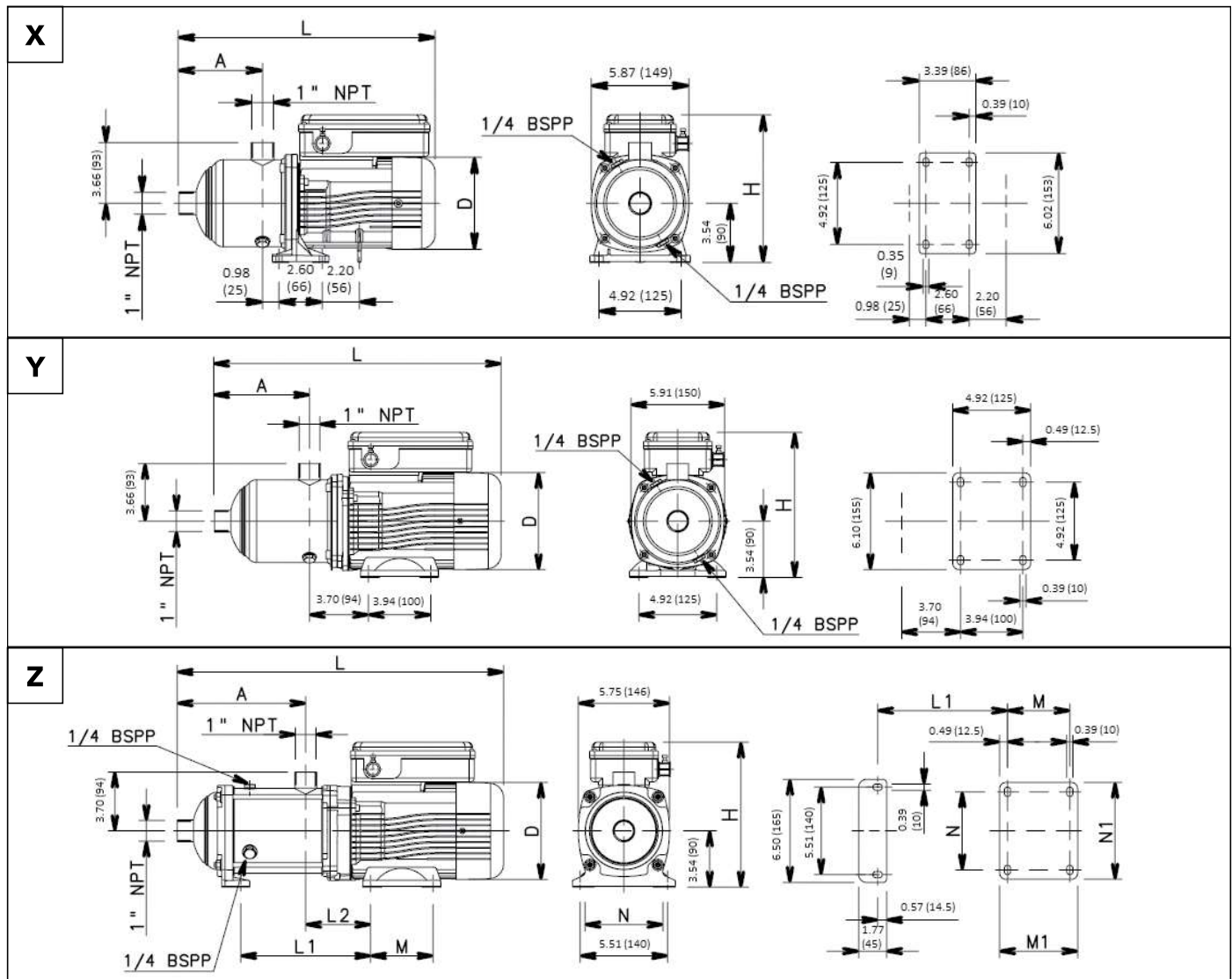

Pump Size Stages	Phase	DWG No.	Motor		Dimensions (in)										Max. Working Pressure (PSI)	Weight (lbs)
			HP	Frame Size	A	D	H	L	L1	L2	M	M1	N	N1		
3HM02	SINGLE PHASE	X	0.75	71	3.43	5.51	8.86	13.78	-	-	-	-	-	-	147	18
3HM03			0.75	71	3.43	5.51	8.86	13.78	-	-	-	-	-	-	147	18
3HM04			0.75	71	4.21	5.51	8.86	14.57	-	-	-	-	-	-	147	20
3HM05			1	71	5.00	5.51	9.13	16.85	-	-	-	-	-	-	147	22
3HM06		Y	1.5	80	5.79	5.94	9.13	17.64	-	-	-	-	-	-	147	31
3HM07		Z	1.5	80	5.94	5.94	9.13	18.43	6.02	4.09	3.94	4.92	4.92	6.10	235	33
3HM08			1.5	80	6.73	5.94	9.13	19.21	6.81	4.09	3.94	4.92	4.92	6.10	235	35
3HM02		THREE PHASE	X	0.75	71	3.43	5.51	8.86	13.78	-	-	-	-	-	-	147
3HM03	0.75			71	3.43	5.51	8.86	13.78	-	-	-	-	-	-	147	18
3HM04	0.75			71	4.21	5.51	8.86	14.57	-	-	-	-	-	-	147	20
3HM05	Y		1	80	5.00	5.51	9.13	16.85	-	-	-	-	-	-	147	29
3HM06			1.5	80	5.79	5.94	9.13	17.64	-	-	-	-	-	-	147	31
3HM07	Z		1.5	80	5.94	5.94	9.13	18.43	6.02	4.09	3.94	4.92	4.92	6.10	235	33
3HM08			2	80	6.73	5.94	9.13	19.21	6.81	4.09	3.94	4.92	4.92	6.10	235	37

### 3HM..N SERIES, (2 TO 8 STAGES) OPERATING CHARACTERISTICS AT 60 HZ, 3500 RPM

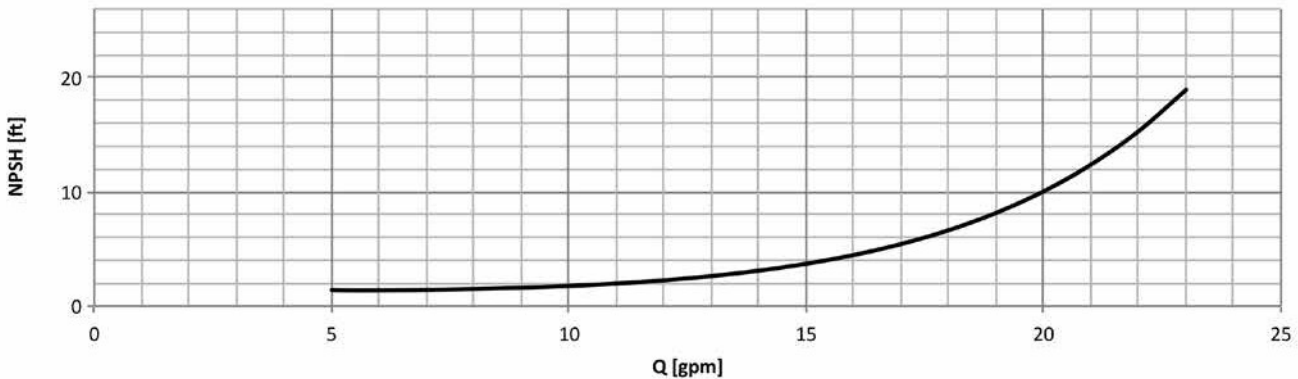
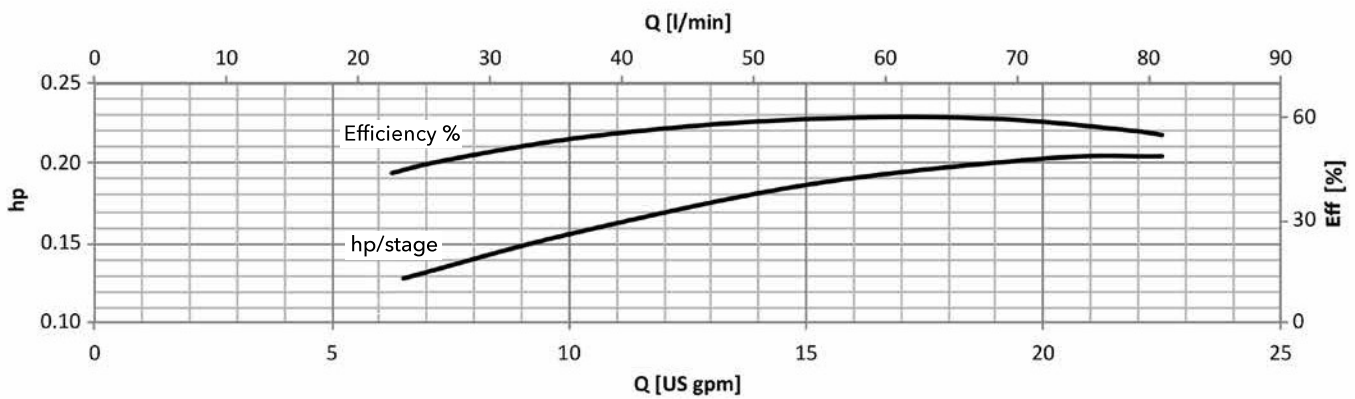
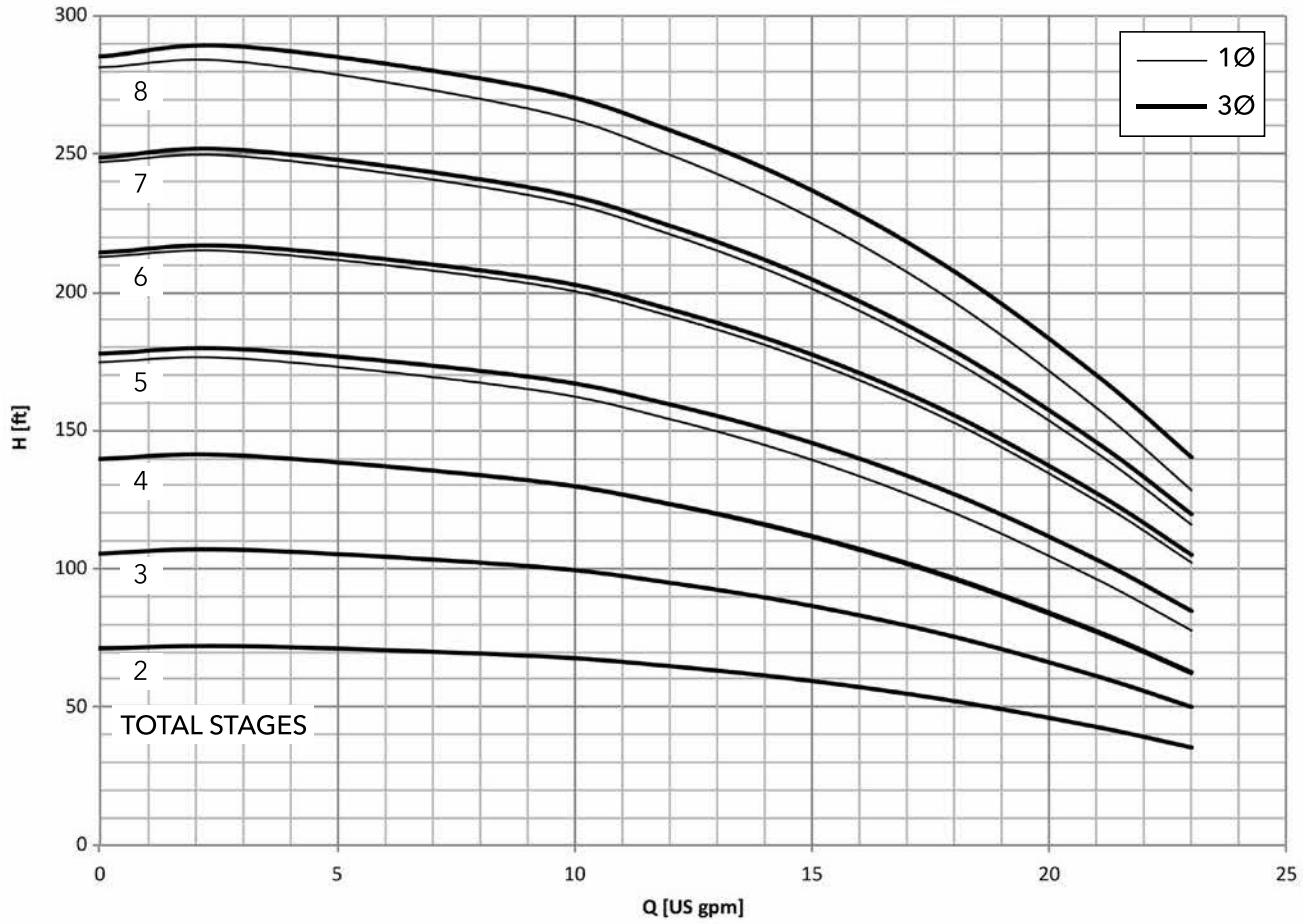

MINIMUM FLOW RATE: 5 GPM

## Commercial Water

### 3HM..N SERIES, (9 TO 14 STAGES)

### DIMENSIONS AND WEIGHTS AT 60 HZ, 3500 RPM

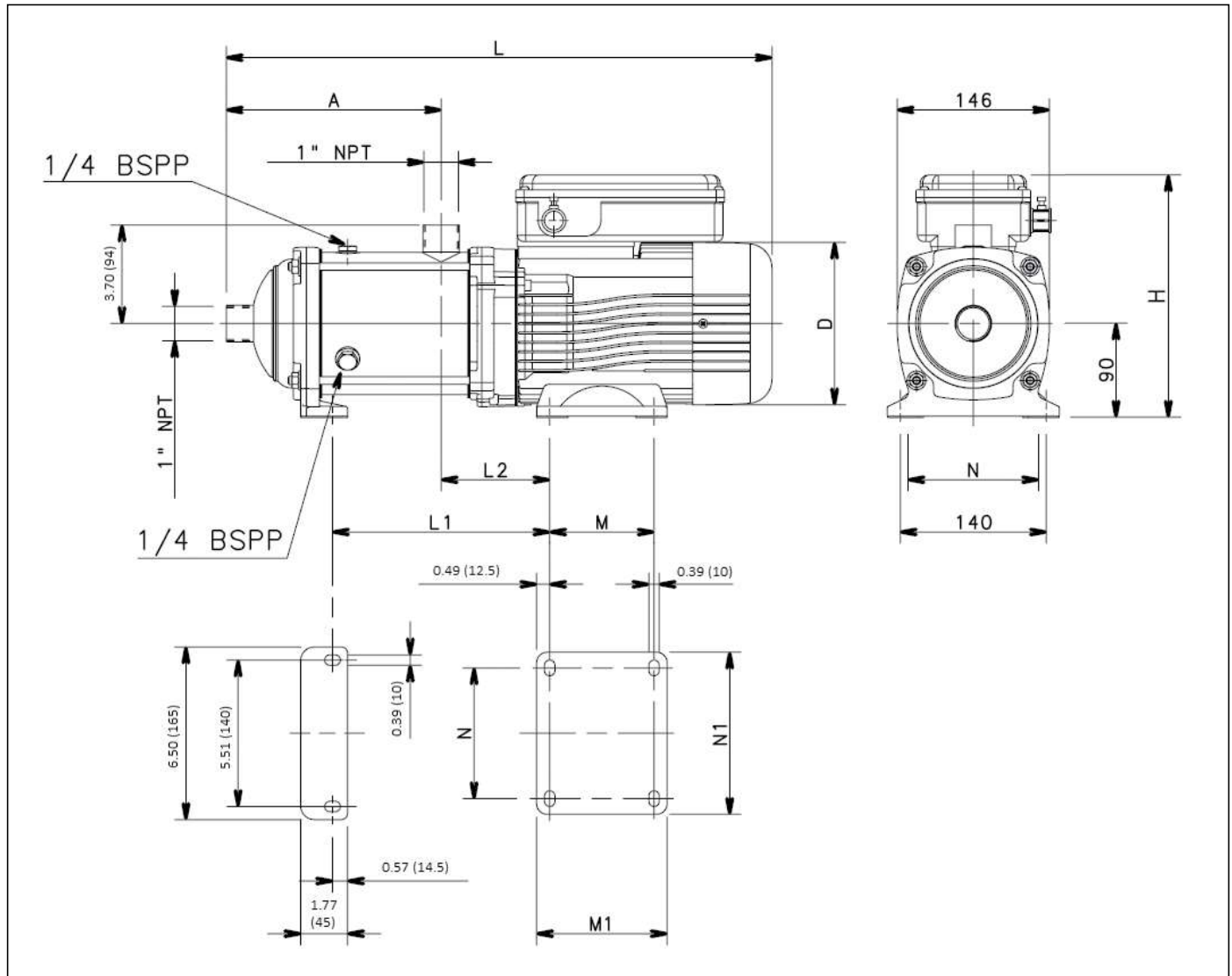

Pump Size Stages	Phase	Motor		Dimensions (in)										Max. Working Pressure (PSI)	Weight (lbs)
		HP	Frame Size	A	D	H	L	L1	L2	M	M1	N	N1		
3HM09	SINGLE PHASE	2	80	7.52	6.10	9.13	20.00	7.60	4.09	3.94	4.92	4.92	6.10	235	37
3HM10		2	80	8.31	6.10	9.13	20.79	8.39	4.09	3.94	4.92	4.92	6.10	235	37
3HM09	THREE PHASE	2	80	7.52	6.10	9.13	20.00	7.60	4.09	3.94	4.92	4.92	6.10	235	37
3HM10		2	80	8.31	6.10	9.13	20.79	8.39	4.09	3.94	4.92	4.92	6.10	235	37
3HM11		3	90	9.09	6.85	9.13	23.58	10.08	5.00	4.92	5.91	5.51	6.46	235	51
3HM12		3	90	9.88	6.85	9.13	24.37	10.87	5.00	4.92	5.91	5.51	6.46	235	51
3HM13		3	90	10.67	6.85	9.13	25.16	11.65	5.00	4.92	5.91	5.51	6.46	235	51
3HM14		3	90	11.46	6.85	9.13	25.94	12.44	5.00	4.92	5.91	5.51	6.46	235	53

### 3HM..N SERIES, (9 TO 14 STAGES) OPERATING CHARACTERISTICS AT 60 HZ, 3500 RPM

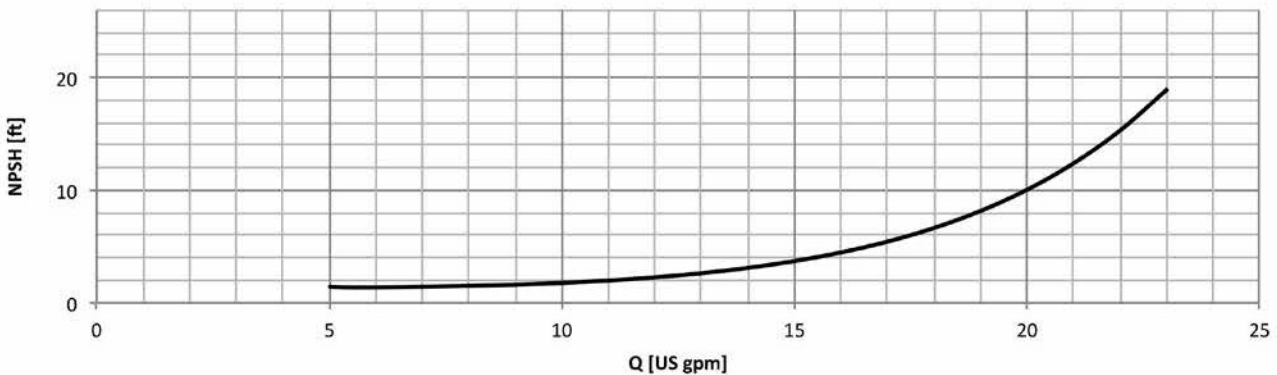
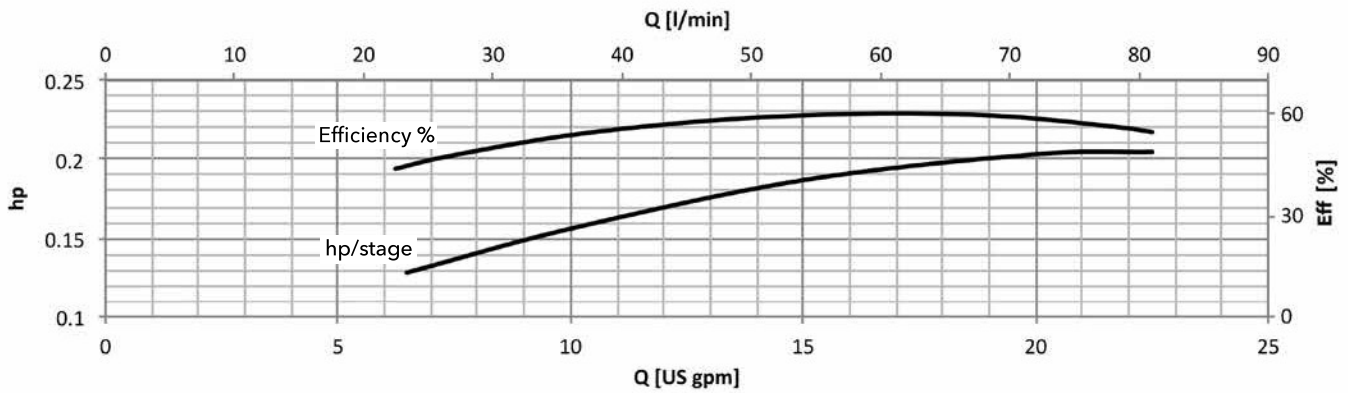
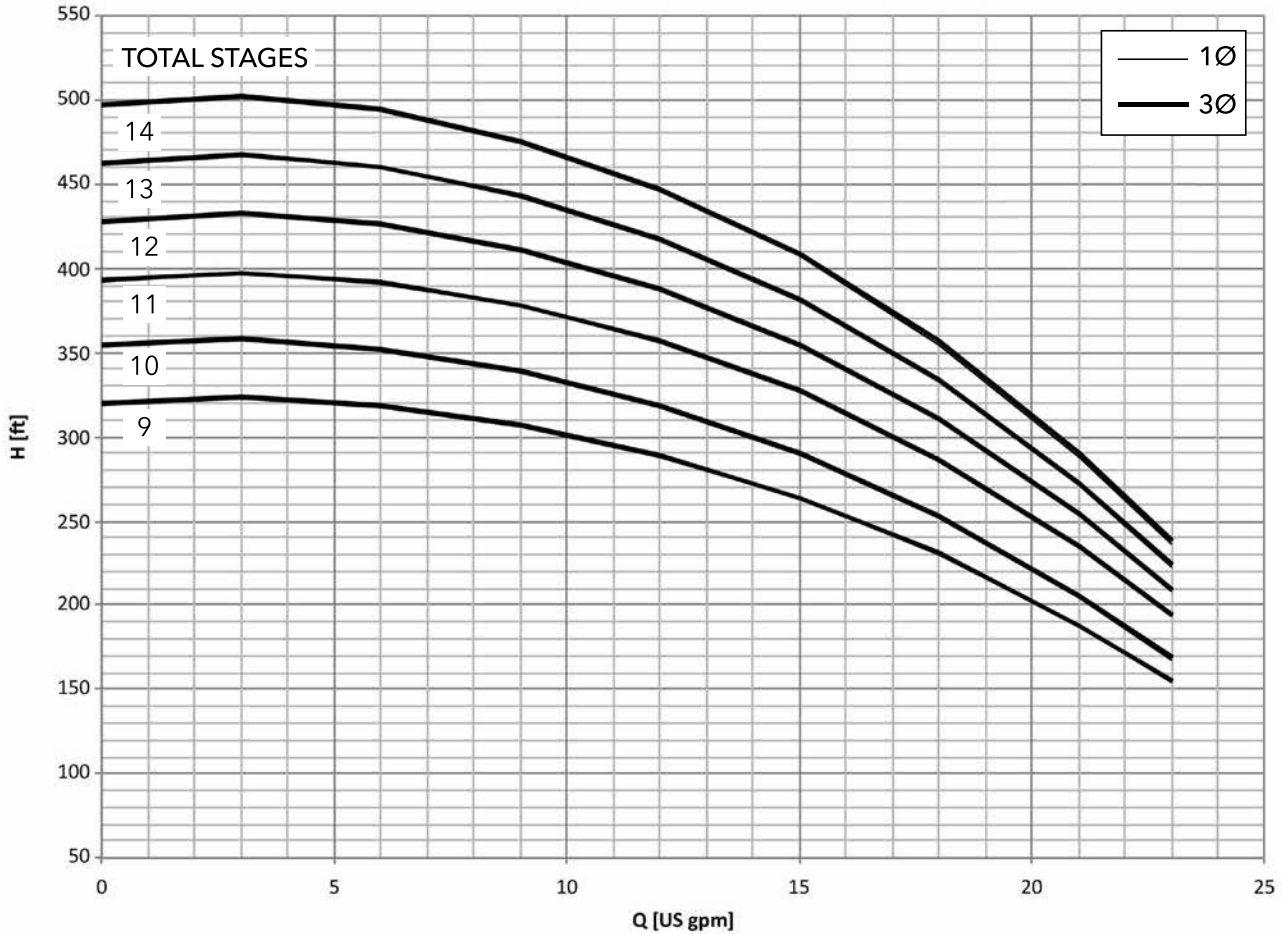

MINIMUM FLOW RATE: 5 GPM

## Commercial Water

### 5HM..N SERIES, (2 TO 7 STAGES) DIMENSIONS AND WEIGHTS AT 60 HZ, 3500 RPM

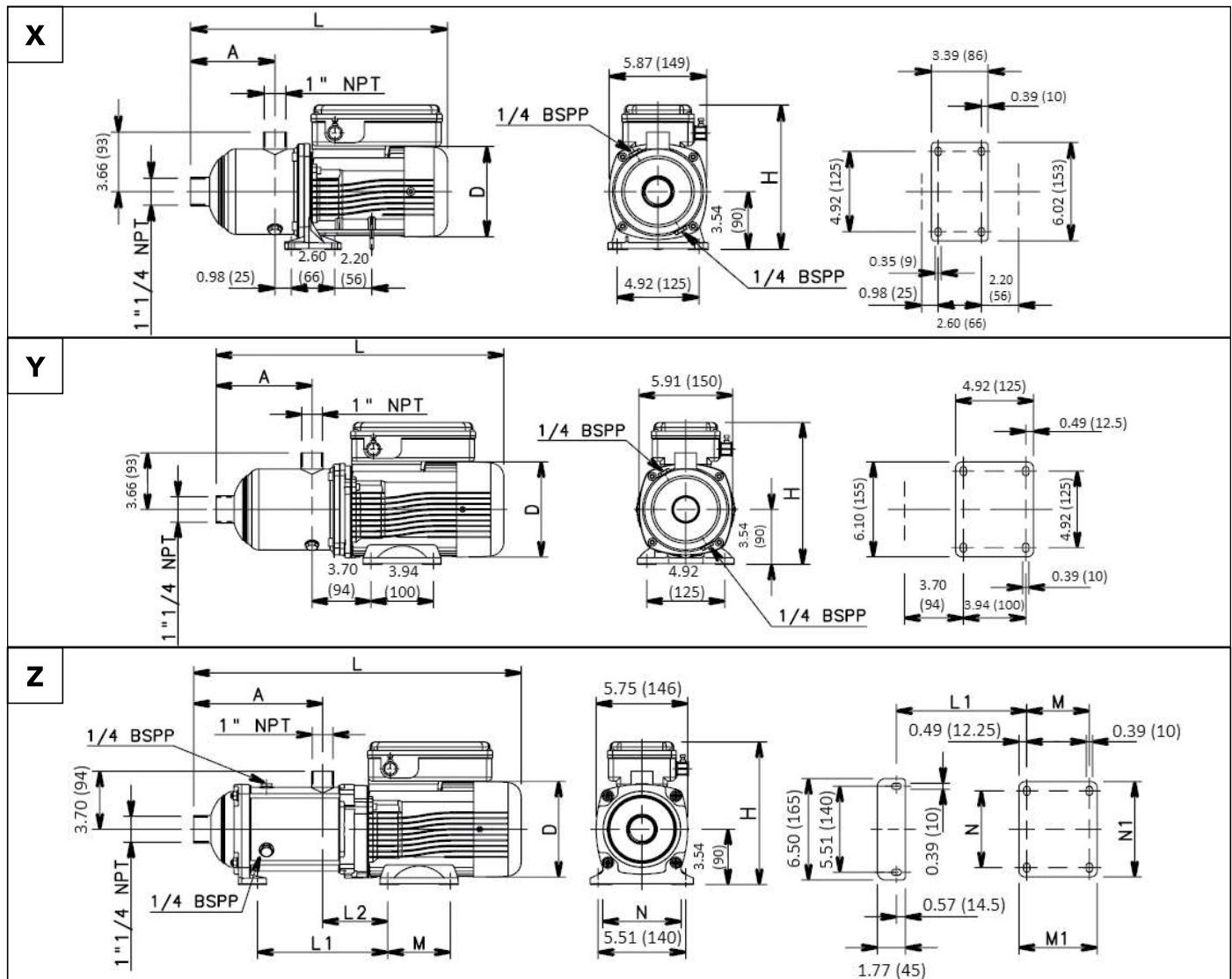

Pump Size Stages	Phase	DWG No.	Motor		Dimensions (in)										Max. Working Pressure (PSI)	Weight (lbs)
			HP	Frame Size	A	D	H	L	L1	L2	M	M1	N	N1		
5HM02	SINGLE PHASE	X	0.75	71	4.09	5.51	8.86	14.45	-	-	-	-	-	-	147	18
5HM03			1	71	4.09	5.51	8.86	14.45	-	-	-	-	-	-	147	20
5HM04		Y	1.5	80	5.08	6.10	9.13	16.93	-	-	-	-	-	-	147	31
5HM05			1.5	80	6.06	6.10	9.13	17.91	-	-	-	-	-	-	147	31
5HM06		Z	2	80	6.22	6.10	9.13	18.70	6.22	4.09	3.94	4.92	4.92	6.10	235	36
5HM02		THREE PHASE	X	0.75	71	4.09	5.51	8.86	14.45	-	-	-	-	-	-	147
5HM03	1			80	4.09	6.10	9.13	15.94	-	-	-	-	-	-	147	27
5HM04	Y		1.5	80	5.08	6.10	9.13	16.93	-	-	-	-	-	-	147	31
5HM05			2	80	6.06	6.10	9.13	17.91	-	-	-	-	-	-	147	34
5HM06	Z		2	80	6.22	6.10	9.13	18.70	6.22	4.09	3.94	4.92	4.92	6.10	235	36
5HM07			3	90	7.20	6.85	9.13	21.89	8.11	5.00	4.92	5.91	5.51	6.46	235	49

### 5HM..N SERIES, (2 TO 7 STAGES) OPERATING CHARACTERISTICS AT 60 HZ, 3500 RPM

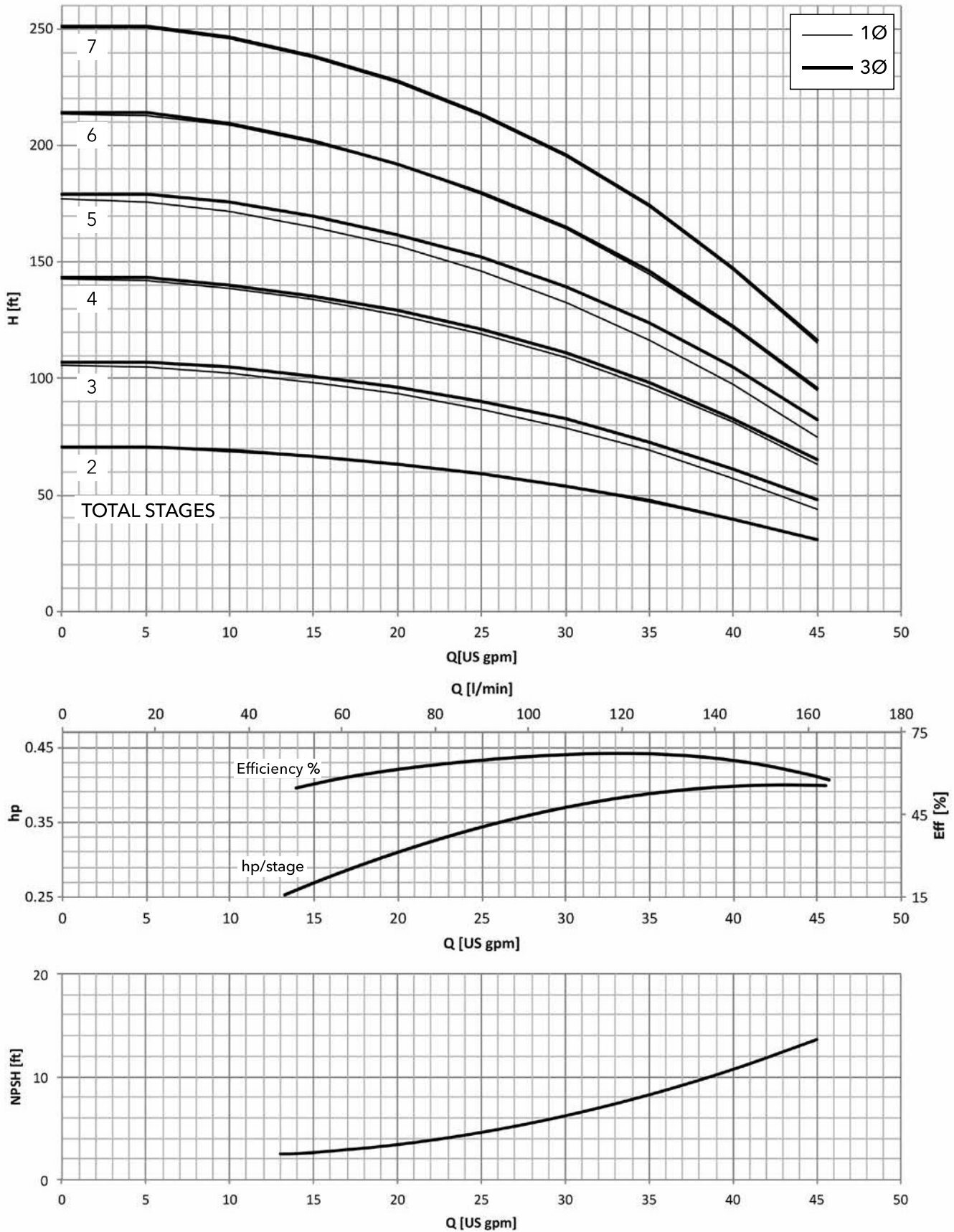

MINIMUM FLOW RATE: 10 GPM



## Commercial Water

### 5HM..N SERIES, (8 TO 12 STAGES) DIMENSIONS AND WEIGHTS AT 60 HZ, 3500 RPM

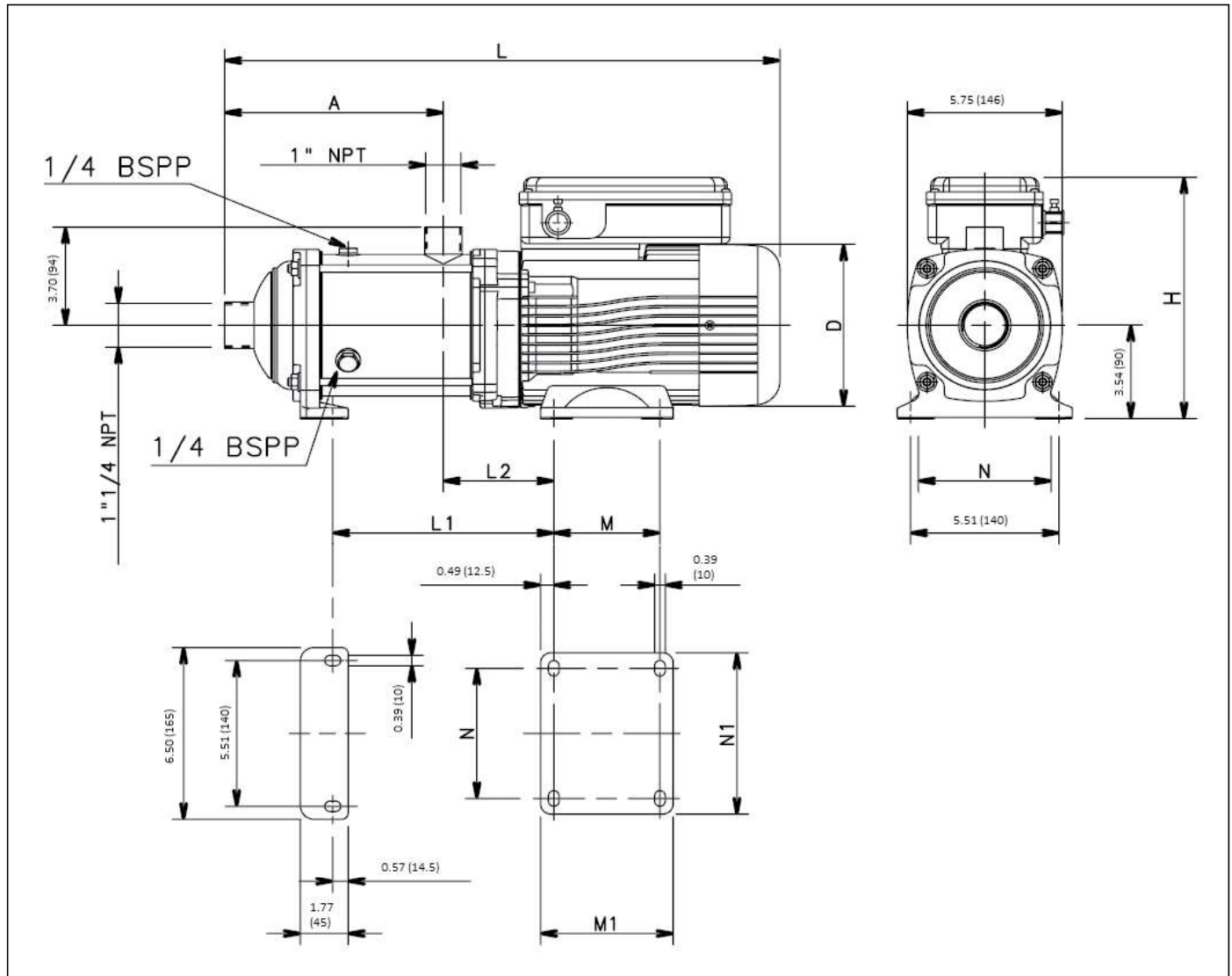

Pump Size Stages	Phase	Motor		Dimensions (in)										Max. Working Pressure (PSI)	Weight (lbs)
		HP	Frame Size	A	D	H	L	L1	L2	M	M1	N	N1		
5HM08	THREE PHASE	3	90	8.19	6.85	9.13	22.87	9.09	5.00	4.92	5.91	5.51	6.46	235	49
5HM09		3	90	9.17	6.85	9.13	23.86	10.08	5.00	4.92	5.91	5.51	6.46	235	51
5HM10		4	90	10.16	6.85	9.13	24.84	11.06	5.00	4.92	5.91	5.51	6.46	235	58
5HM11		4	90	11.14	6.85	9.13	25.83	12.05	5.00	4.92	5.91	5.51	6.46	235	60
5HM12		4	90	12.13	6.85	9.13	26.81	13.03	5.00	4.92	5.91	5.51	6.46	235	60

### 5HM..N SERIES, (8 TO 12 STAGES) OPERATING CHARACTERISTICS AT 60 HZ, 3500 RPM

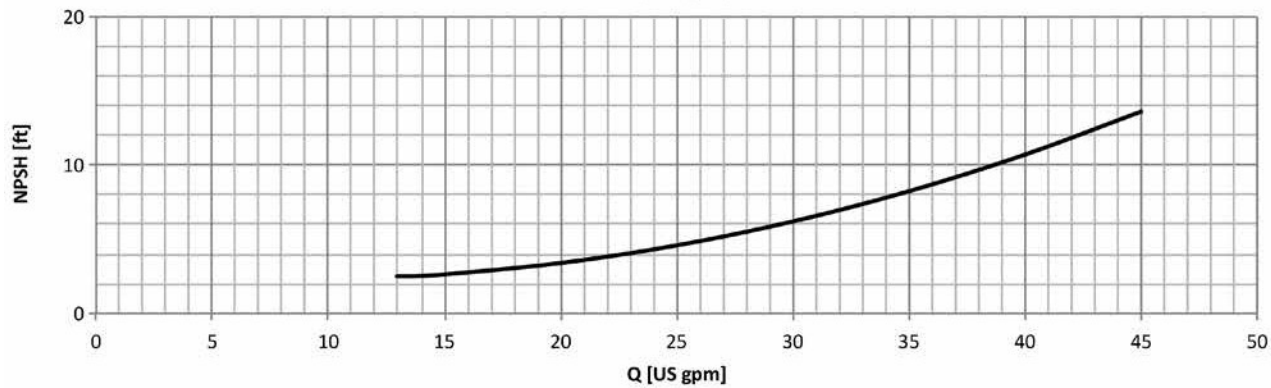
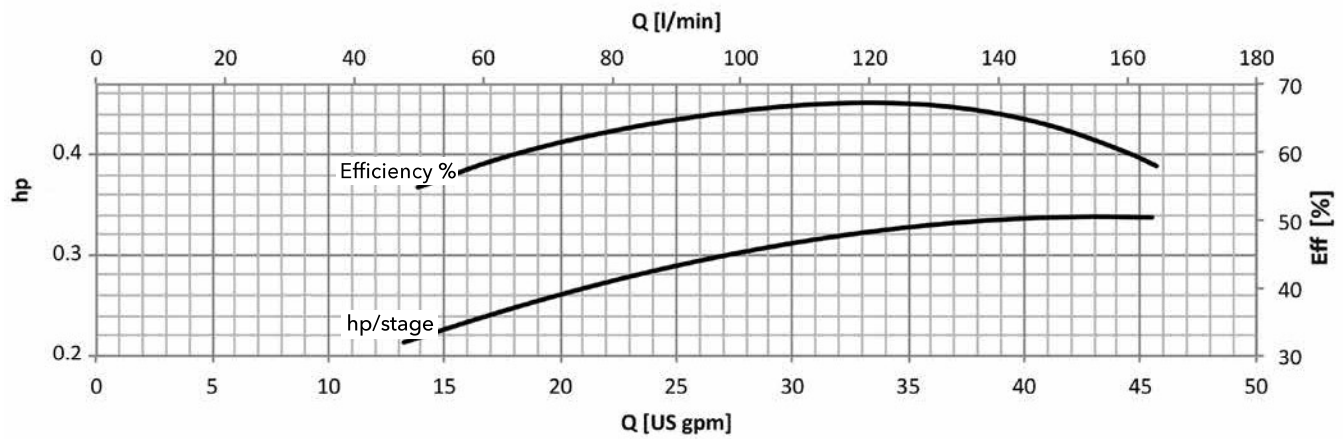
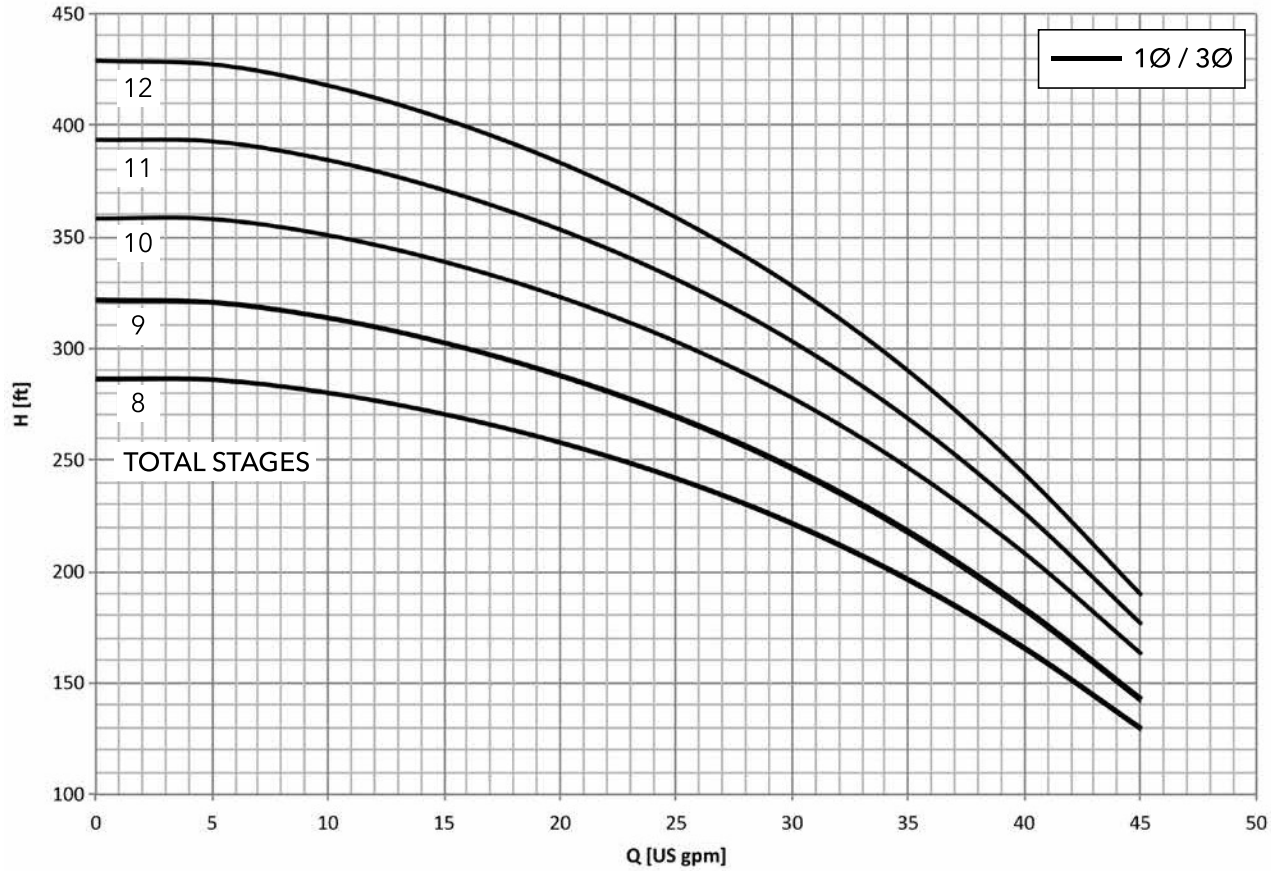

MINIMUM FLOW RATE: 10 GPM

## Commercial Water

### 10HM..N SERIES, (1 TO 8 STAGES) DIMENSIONS AND WEIGHTS AT 60 HZ, 3500 RPM

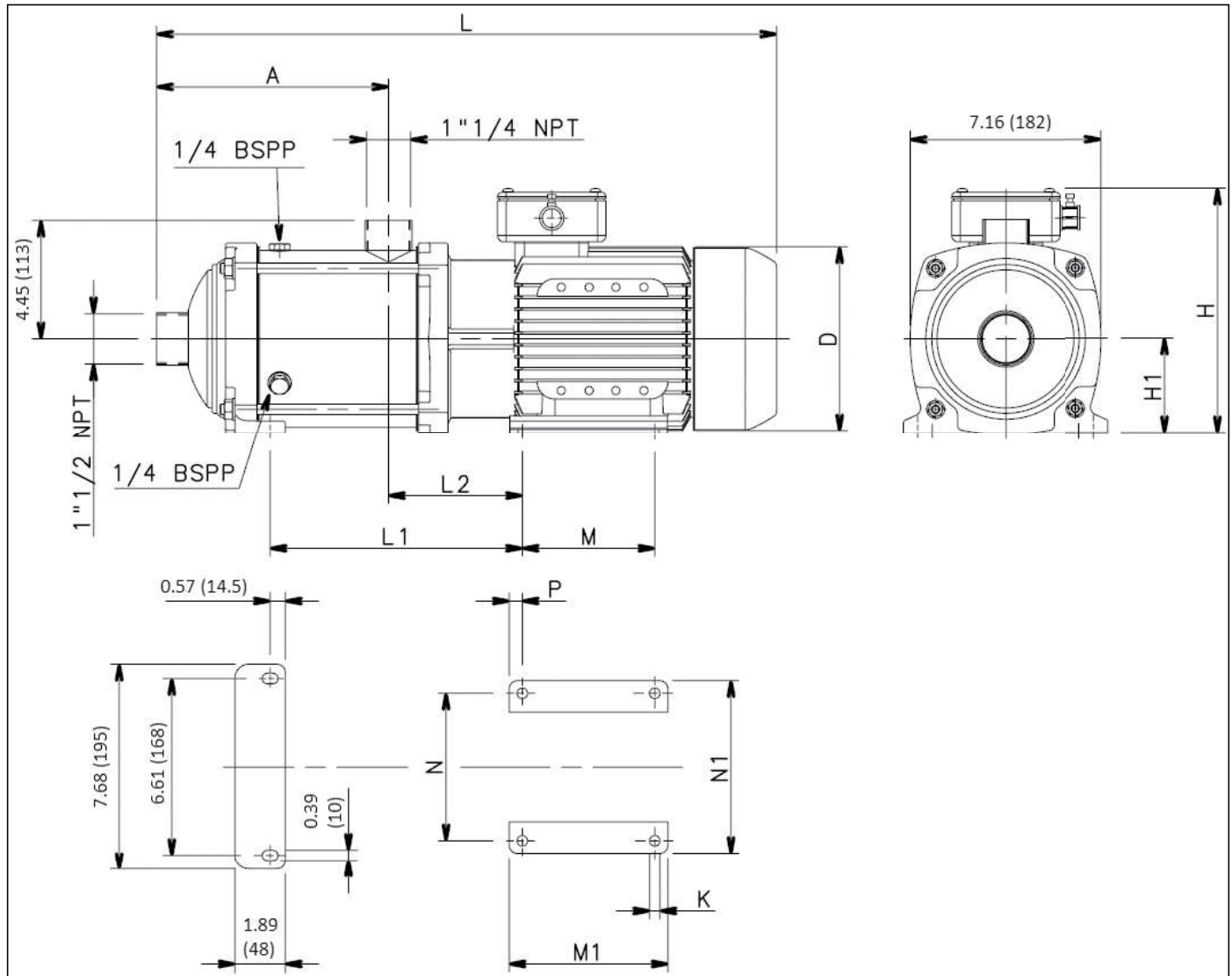

Pump Size Stages	Phase	Motor		Dimensions (in)													Max. Working Pressure (PSI)	Weight (lbs)
		HP	Frame Size	A	D	H	H1	L	L1	L2	M	M1	N	N1	P	K		
10HM01	SINGLE PHASE	1.5	80	4.92	6.1	9.13	3.54	17.44	4.8	4.13	3.94	4.92	4.92	6.1	0.49	0.39	235	36
10HM02		2	80	4.92	6.1	9.13	3.54	17.44	4.8	4.13	3.94	4.92	4.92	6.1	0.49	0.39	235	38
10HM01	THREE PHASE	1	80	4.92	6.1	9.13	3.54	17.44	4.8	4.13	3.94	4.92	4.92	6.1	0.49	0.39	235	34
10HM02		2	80	4.92	6.1	9.13	3.54	17.4	4.8	4.13	3.94	4.92	4.92	6.1	0.49	0.39	235	38
10HM03		3	90	4.92	6.85	9.13	3.54	19.45	5.67	5.04	4.92	5.91	5.51	6.46	0.49	0.39	235	51
10HM04		4	90	6.18	6.85	9.13	3.54	20.71	6.93	5.04	4.92	5.91	5.51	6.46	0.49	0.39	235	60
10HM05		5.5	100	7.44	7.76	10	3.94	23.31	8.98	5.79	5.51	6.69	6.3	7.24	0.59	0.47	235	75
10HM06		5.5	100	8.7	7.76	10	3.94	24.57	10.24	5.79	5.51	6.69	6.3	7.24	0.59	0.47	235	78
10HM07		7.5	112	9.96	8.43	11.02	4.41	27.17	11.77	6.06	5.51	6.69	7.48	8.62	0.59	0.47	235	95
10HM08		7.5	112	11.22	8.43	11.02	4.41	28.43	13.03	6.06	5.51	6.69	7.48	8.62	0.59	0.47	235	98

### 10HM..N SERIES, (1 TO 8 STAGES) OPERATING CHARACTERISTICS AT 60 HZ, 3500 RPM

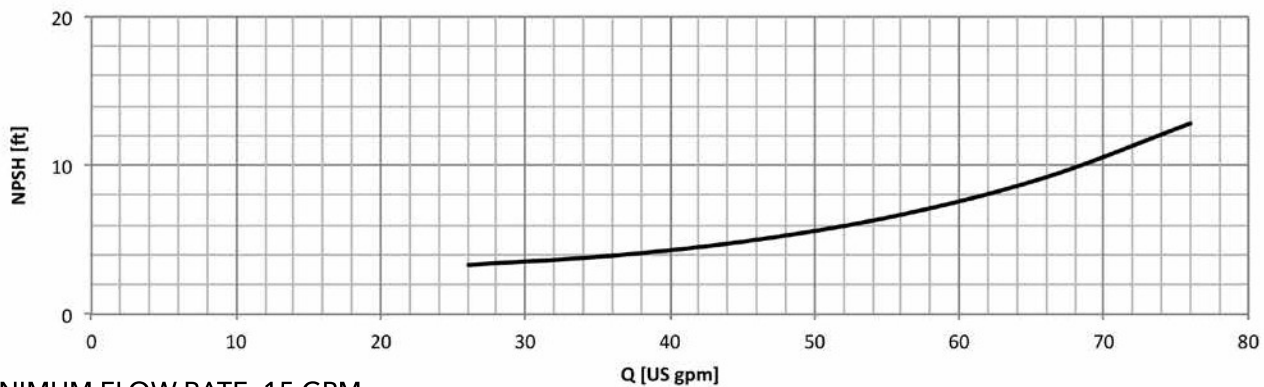
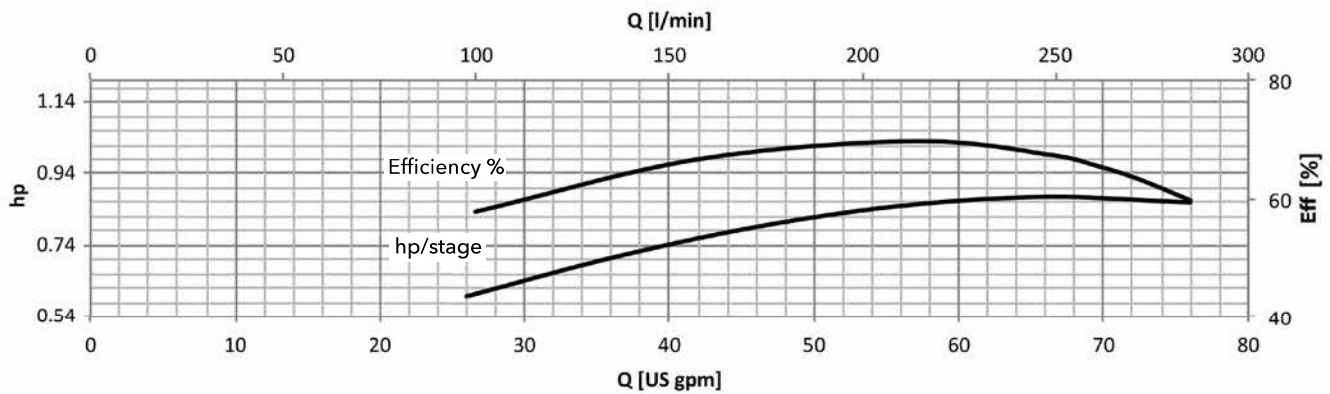
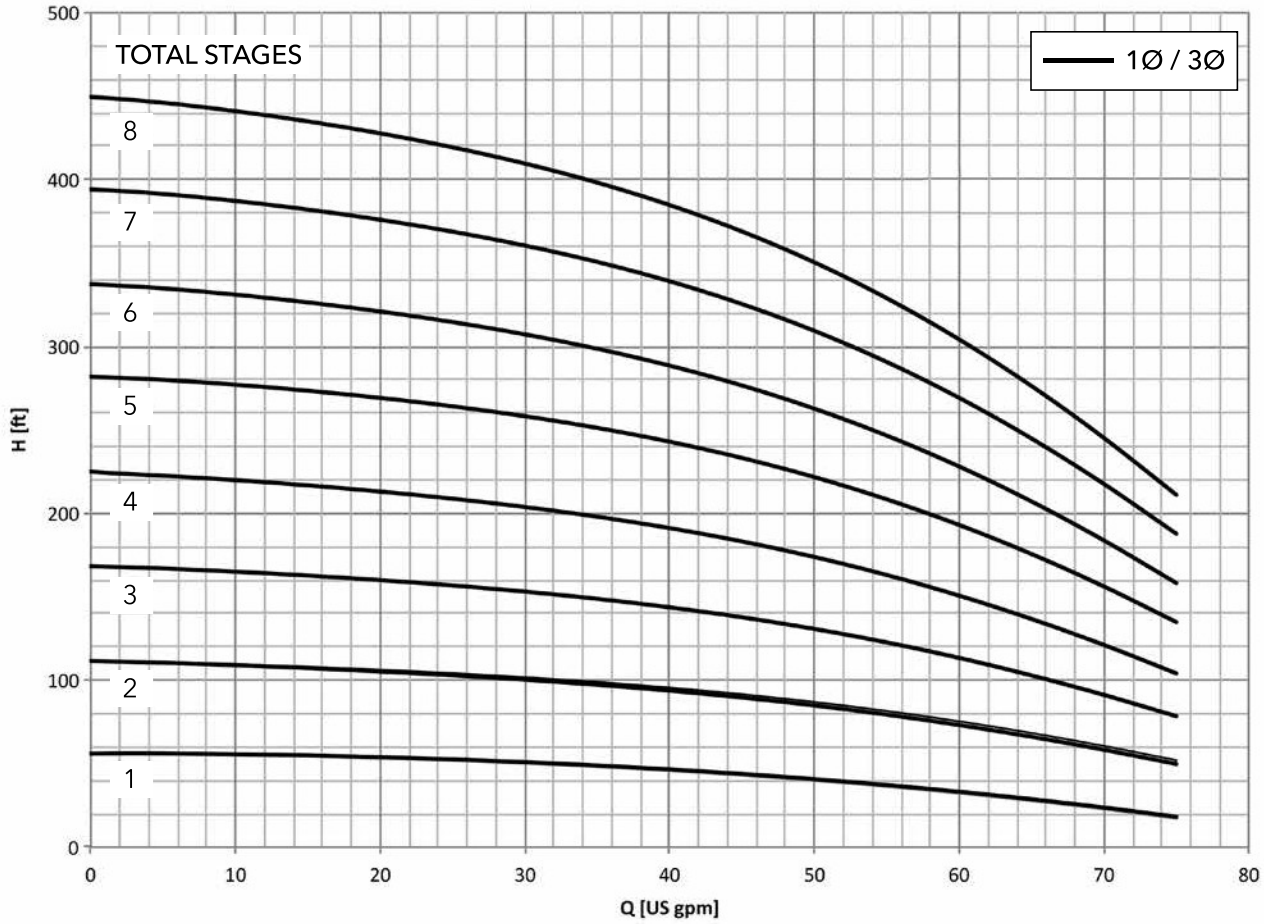

MINIMUM FLOW RATE: 15 GPM

## Commercial Water

### 15HM..N SERIES, (1 TO 4 STAGES) DIMENSIONS AND WEIGHTS AT 60 HZ, 3500 RPM

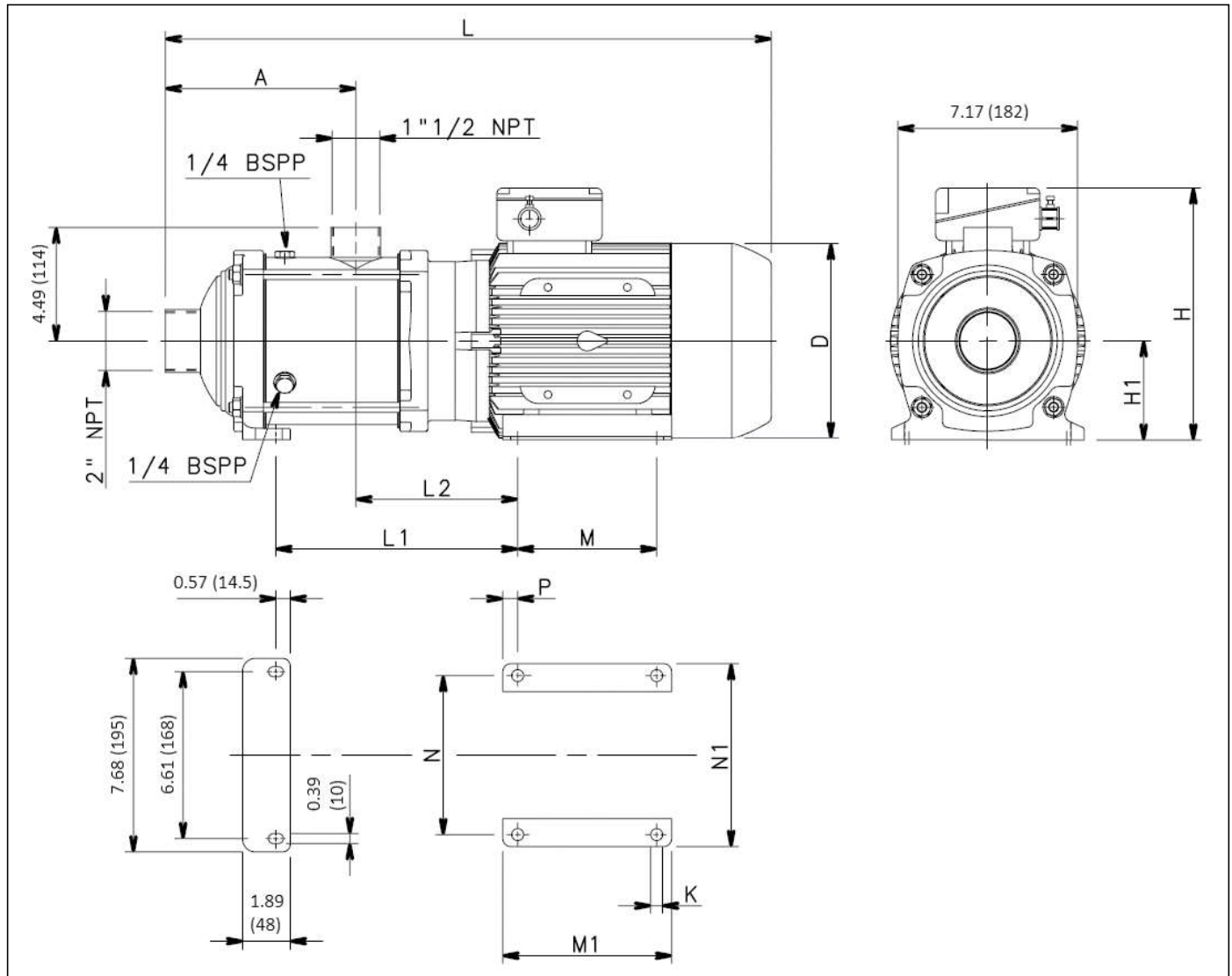

Pump Size Stages	Phase	Motor		Dimensions (in)														Max. Working Pressure (PSI)	Weight (lbs)
		HP	Frame Size	A	D	H	H1	L	L1	L2	M	M1	N	N1	P	K			
15HM01	SINGLE PHASE	2	80	5.67	6.10	9.13	3.54	18.82	6.06	4.76	3.94	4.92	4.92	6.10	0.49	0.39	235	38	

15HM01	THREE PHASE	2	80	5.67	6.10	9.13	3.54	18.82	6.06	4.76	3.94	4.92	4.92	6.10	0.49	0.39	235	38
15HM02		4	90	5.67	6.85	9.13	3.54	20.87	6.93	5.67	4.92	5.91	5.51	6.46	0.49	0.39	235	58
15HM03		5.5	100	5.67	7.76	10.00	3.94	22.17	7.72	6.42	5.51	6.69	6.30	7.24	0.59	0.47	235	71
15HM04		7.5	112	7.56	8.43	11.02	4.41	25.39	9.88	6.69	5.51	6.69	7.48	8.62	0.59	0.47	235	89

### 15HM..N SERIES, (1 TO 4 STAGES) OPERATING CHARACTERISTICS AT 60 HZ, 3500 RPM

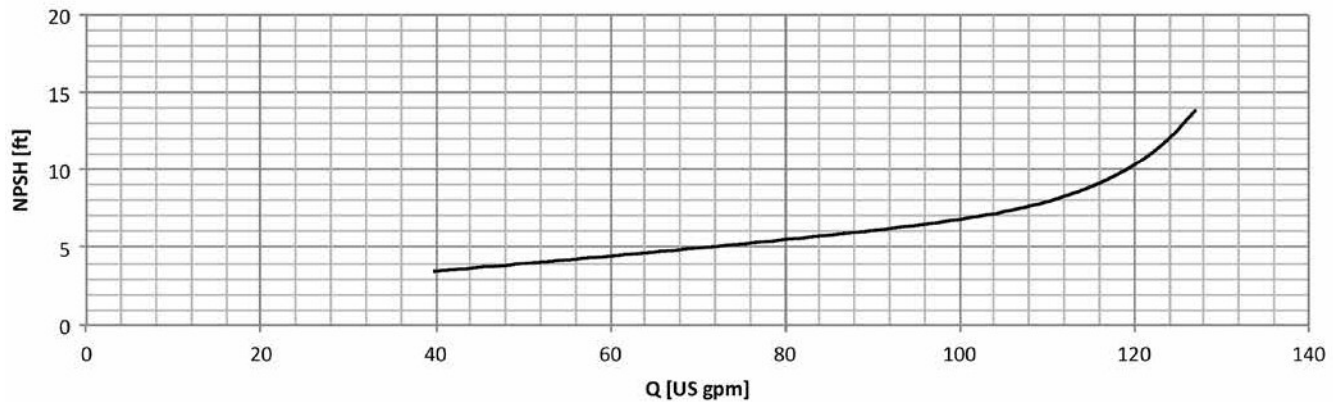
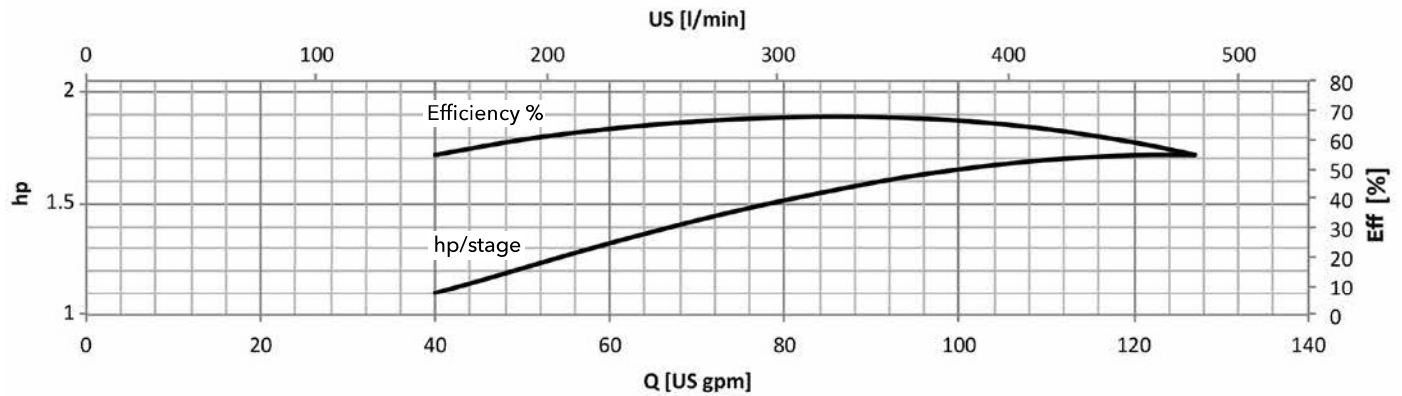
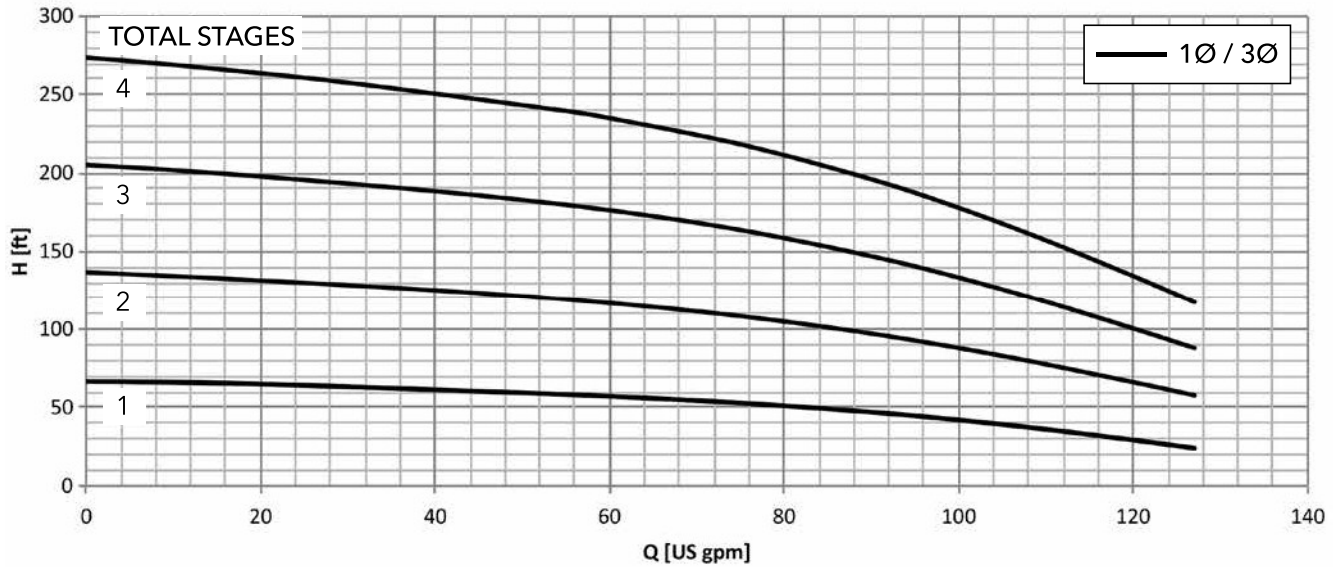

## Commercial Water

### 22HM..N SERIES, (1 TO 3 STAGES) DIMENSIONS AND WEIGHTS AT 60 HZ, 3500 RPM

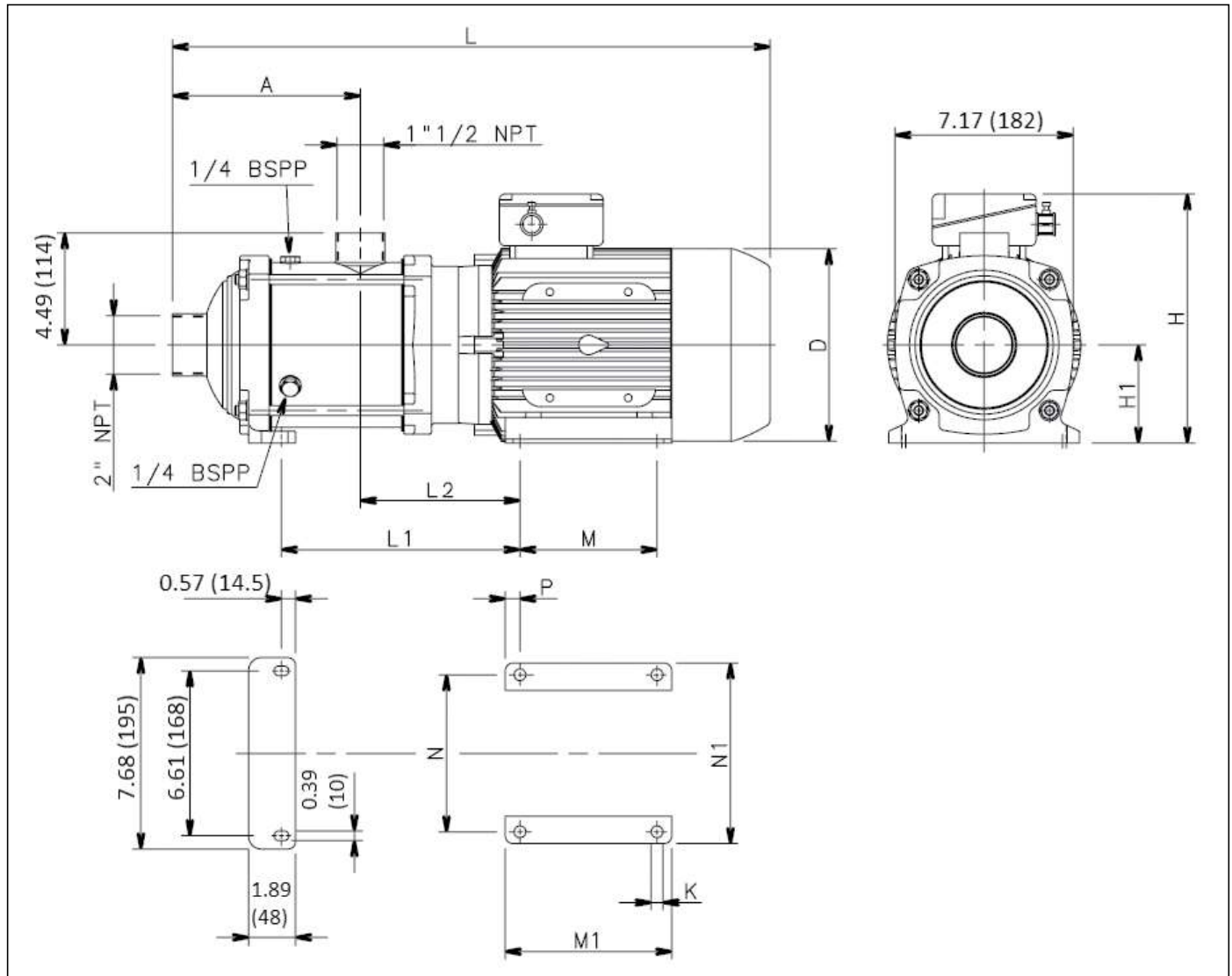

Pump Size Stages	Phase	Motor		Dimensions (in)													Max. Working Pressure (PSI)	Weight (lbs)
		HP	Frame Size	A	D	H	H1	L	L1	L2	M	M1	N	N1	P	K		
22HM01	THREE PHASE	3	90	5.67	6.85	9.13	3.54	20.83	6.93	5.67	4.92	5.91	5.51	6.46	0.49	0.39	235	49
22HM02		5.5	100	5.67	7.76	10.00	3.94	22.17	7.72	6.42	5.51	6.69	6.30	7.24	0.59	0.47	235	71
22HM03		7.5	112	5.67	8.43	11.02	4.41	23.50	7.99	6.69	5.51	6.69	7.48	8.62	0.59	0.47	235	86

### 22HM..N SERIES, (1 TO 3 STAGES) OPERATING CHARACTERISTICS AT 60 HZ, 3500 RPM

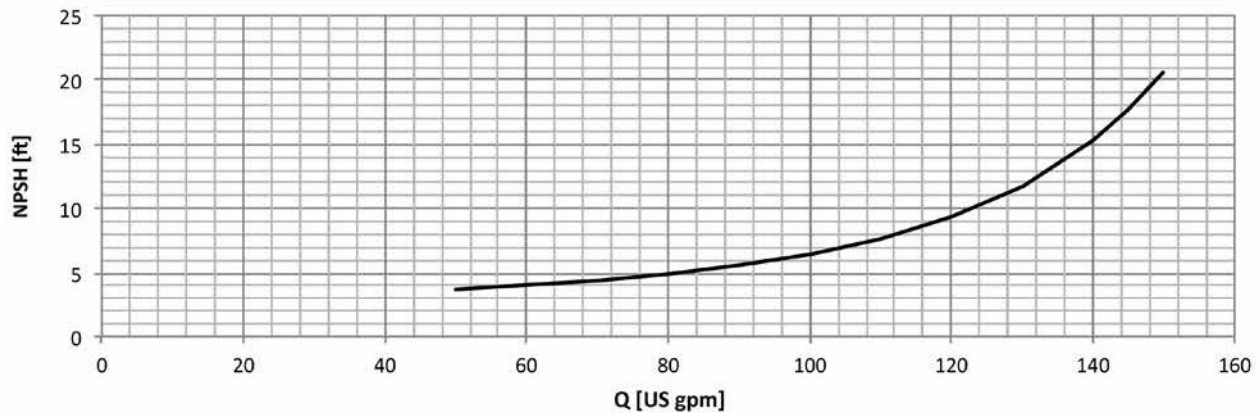
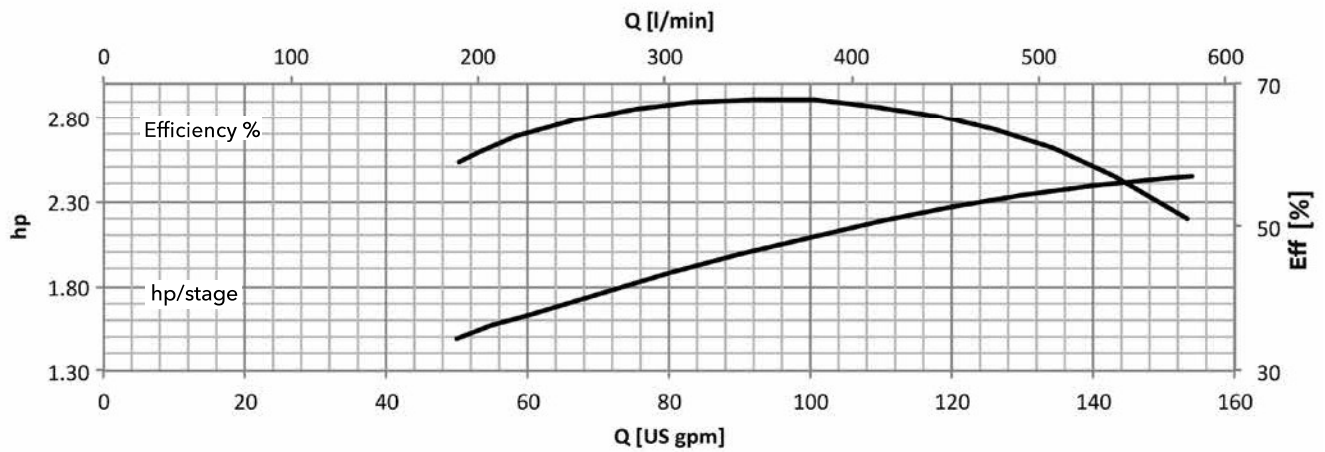
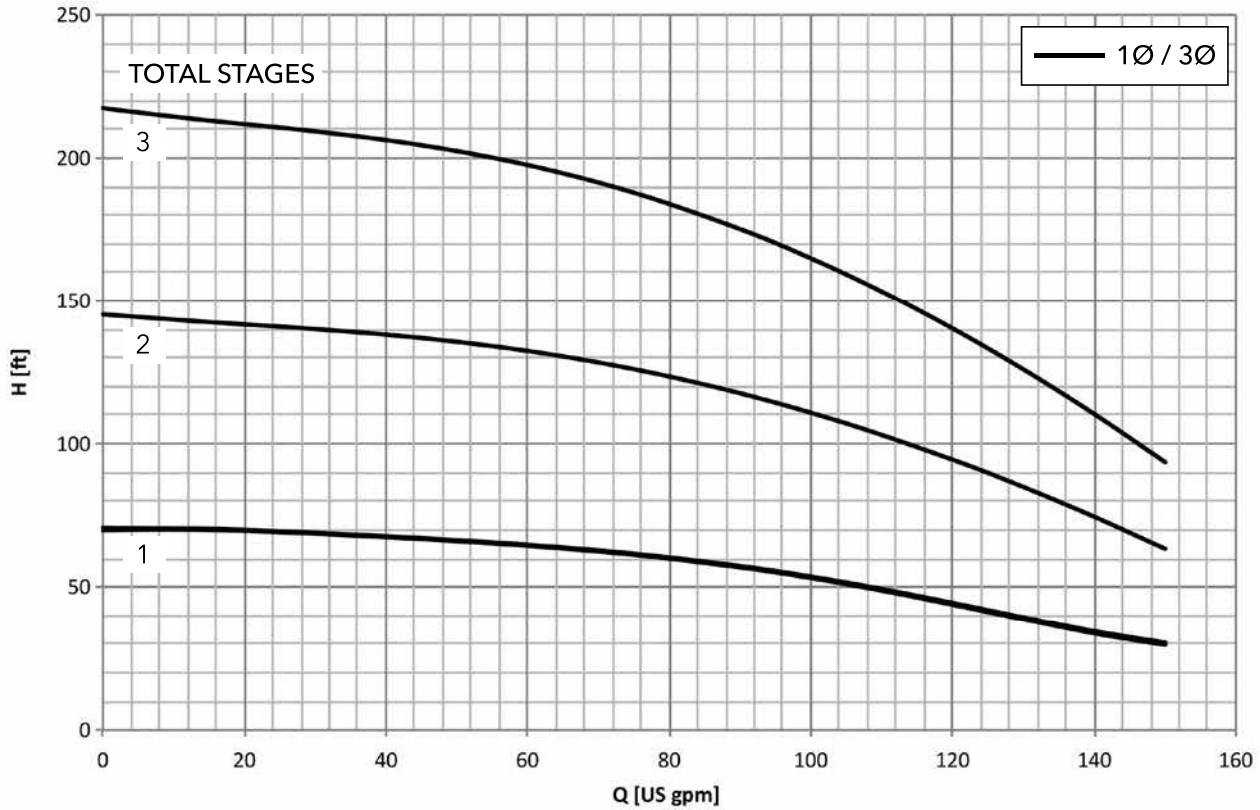

MINIMUM FLOW RATE: 30 GPM



## Commercial Water

### e-HME VERSION WITH DRIVE AND SMART MOTOR (PERMANENT MAGNET MOTOR)

#### e-HME SMART SERIES

##### Savings

The electronics and permanent magnet motor are highly efficient and minimize power losses while transferring maximum energy to the hydraulic parts of the pump.

The refined control system with integrated microprocessor adjusts the motor speed, matching the required operating point of the pump or system requirements.

This reduces demand on electricity according to the required working conditions.

This creates economies, especially in systems where pump demand varies over time.

##### Flexibility

The compact size, low loss and increased control make the e-HME smart series a good choice in applications and systems where fixed speed pumps are commonly used. The e-HME smart series is easy to integrate in control and regulation loops thanks to the wide availability of compatible communication protocols, including analog and digital inputs. The pump is supplied with a pressure sensor.

##### Ease of use and commissioning

e-HME smart series has an intuitive interface that guides the user through the installation, and a practical area to assist with connections.

The control system is integrated and no additional external electrical panel is required.

##### Applications

- Water supply systems in residential buildings
- Circulation of hot and cold liquids for heating, cooling and conditioning systems.
- Water treatment plants
- Industrial installations

##### Motor Specifications

- Voltage: single phase, 208-230V to 2 HP, three phase 208-230/460V to 3 HP
- Power: up to 3 HP (2.2 kW)
- Multipump capability: up to 3 units
- Power supply: 50/60 Hz



- Comms: BACnet and Modbus standard for single pumps
- Motor: IES2 package with IE5 motors
- Enclosure rating: IP55 / NEMA 3R
- Ambient temperature: -4°F/ 122°F (20°C / +50°C) full power

##### e-HME Specifications

- Delivery: Up to 130 GPM (30m<sup>3</sup>/h)
- Head: Up to 540 feet (165 m)
- Liquid temperature: Up to 194°F (90°C)
- Pressure: 145 psi compact pump design  
230 psi sleeve pump design
- Power range: 0.5-3 HP (0.37 - 2.2 kW)

##### e-HME NAMEPLATE

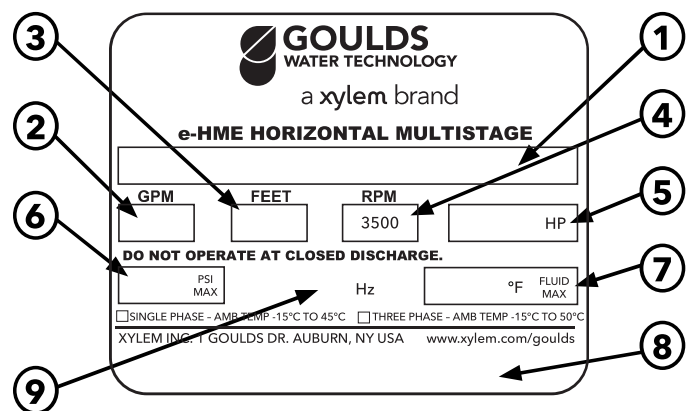

1	Catalog Number
2	Capacity Range
3	TDH Range
4	Rated Speed
5	Rated Horsepower
6	Maximum Operating Pressure
7	Maximum Fluid Temperature
8	Pump Serial Number
9	Rated Hz

## Commercial Water

### e-HME SERIES • e-HM SMART SERIES

e-HM Smart series is equipped with an intelligent control that optimizes hydraulic performance while minimizing waste.

**Integrated intelligence:** The electronic control of the motor enables a 12% increase in performance compared to an equivalent fixed speed pump.

**Extended working performances**  
(e-HME vs e-HM)

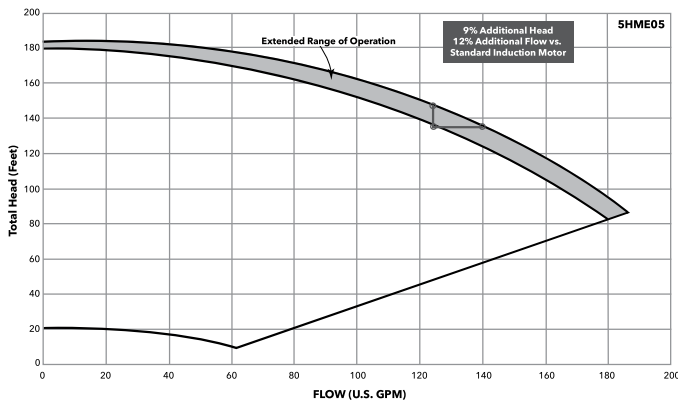

**Adjustment:** This is possible both at constant pressure and according to the characteristic curve of the system, based on the customer's preferences. Another option is according to an external signal or at a preset speed.

### Controls, safety features and monitoring tools

Available control modes include:

- Control for constant pressure
- Control to match a system curve
- Control according to an external signal

In addition to these regulation functions, the Smart Motor also:

- Stops the pump at zero demand
- Stops the pump in case of water failure
- Allows protection against dry running
- Has failure and over-temperature sensors for both the inverter and motor, which protects the pump and motor from under or over-voltage

**Intuitive and simple interface:** You can control the unit from just three buttons, with an easy to read display for parameters and alarms, designed for complete control of system operation.

- ① Communication LED
- ② Power on LED
- ③ Unit of measure LED
- ④ Speed LED bar
- ⑤ Status LED
- ⑥ Numeric display
- ⑦ Decrease key
- ⑧ On/off and menu key
- ⑨ Increase key

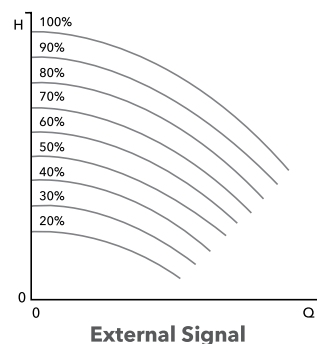
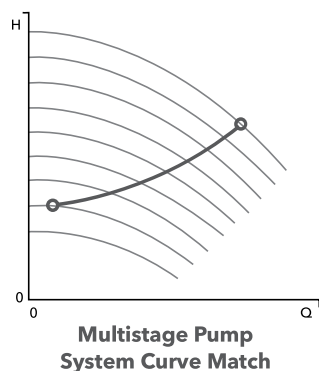
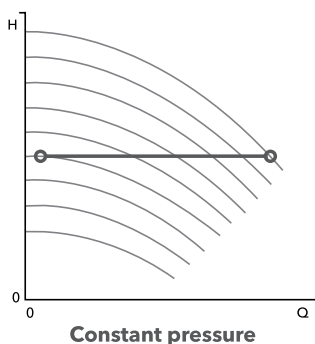
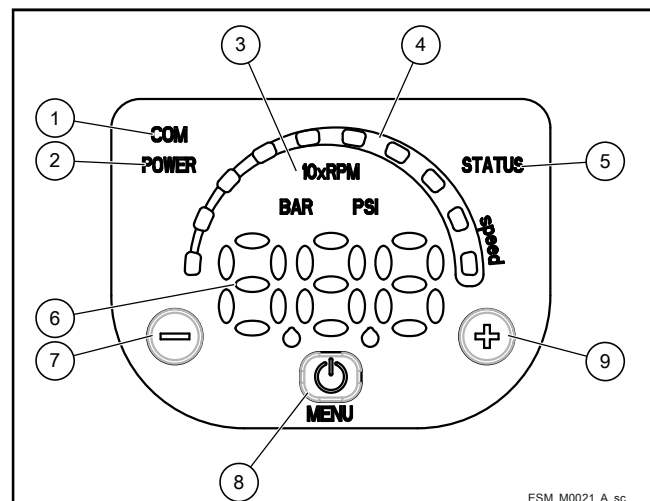

### e-HME Hydraulic Coverage Curve

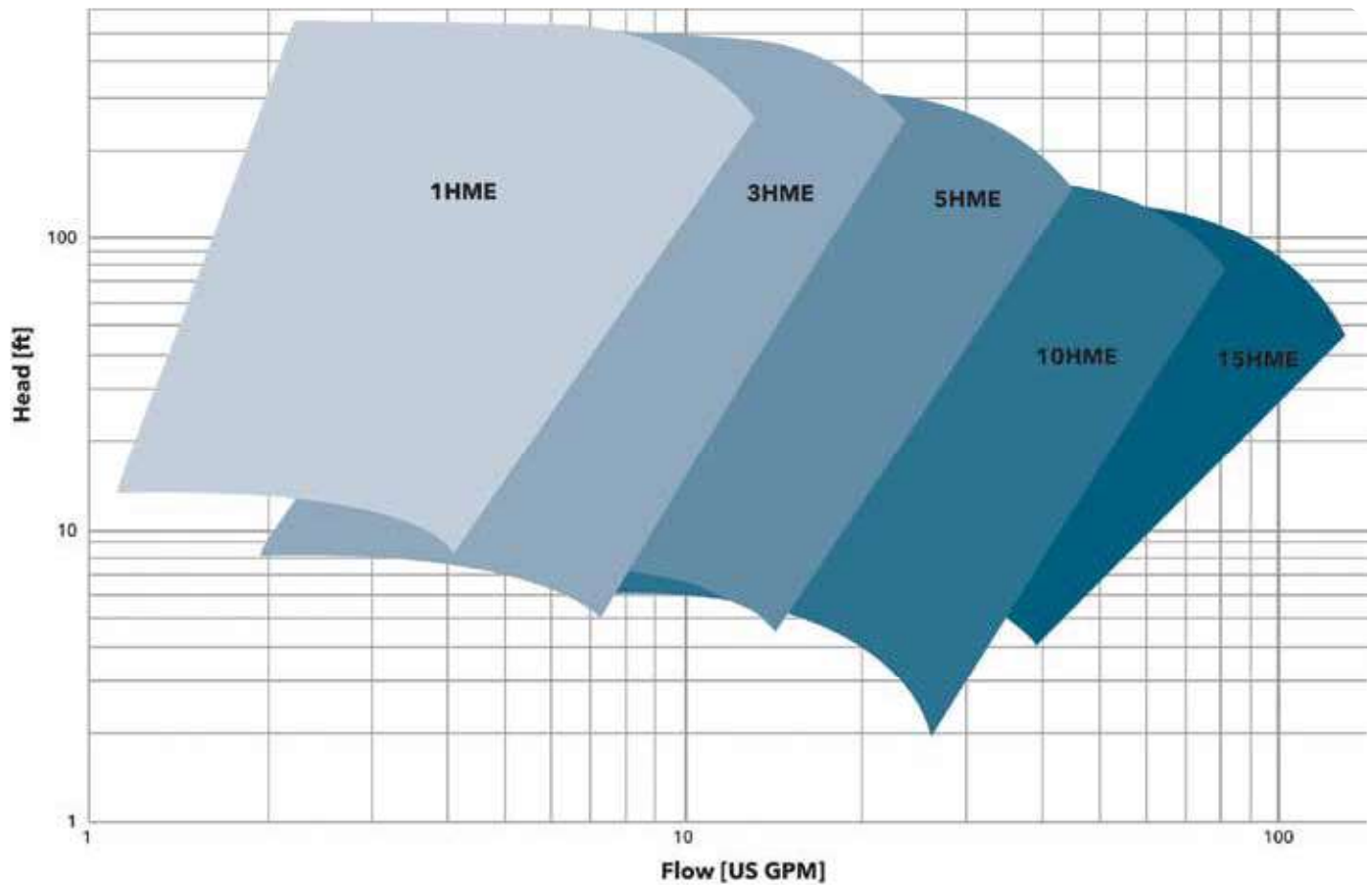

### NUMBERING SYSTEM FOR 1-15HME PUMPS

The various versions of the e-HME line are identified by a product code number on the pump label. This number is also the catalog number for the pump. The meaning of each digit in the product code number is shown below.

Note: Not all combinations are possible.

#### Example Product Code

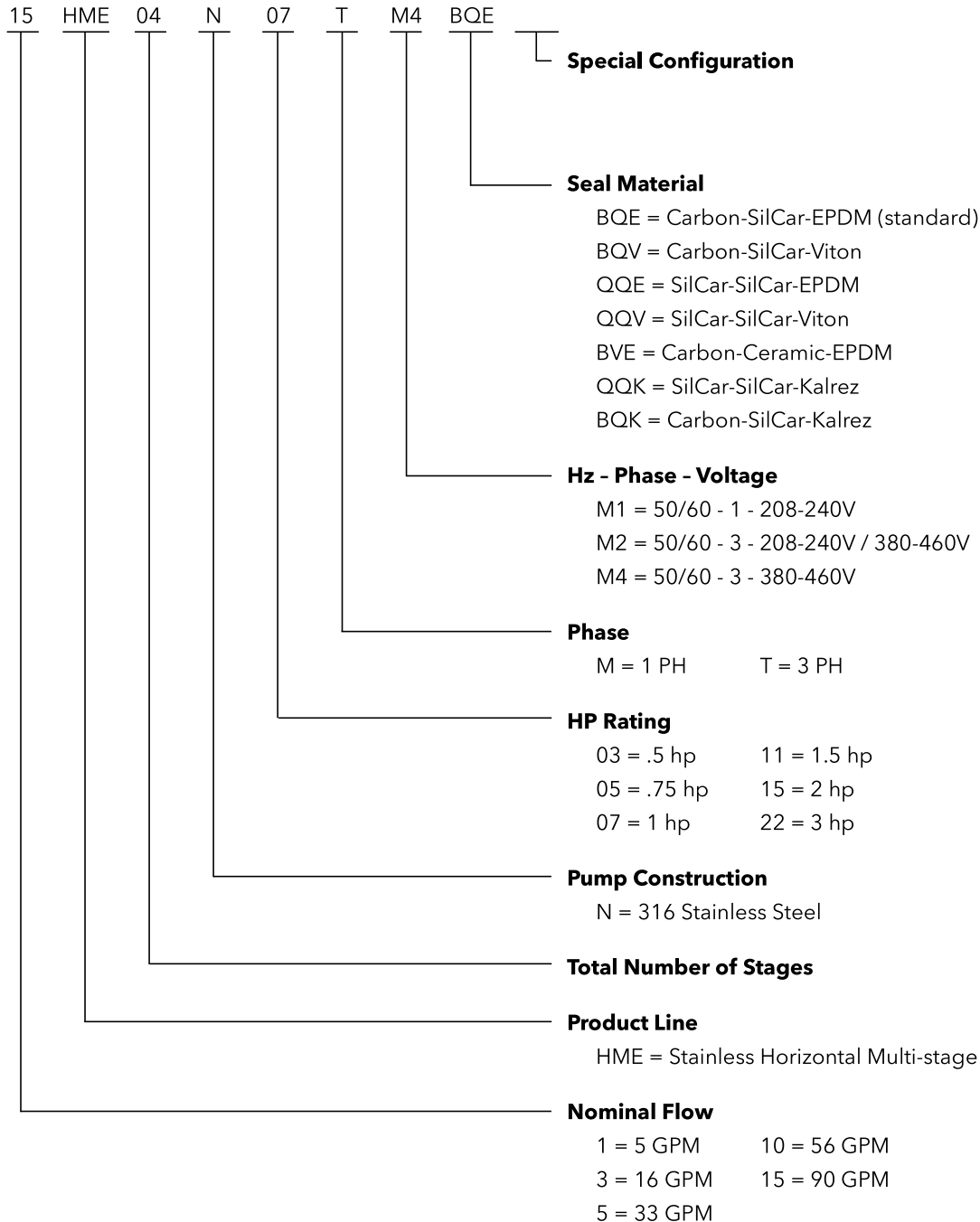

\* For CE compliant 50 Hz motors, please contact the factory

## Commercial Water

### e-HME SERIES SINGLE PHASE TERMINAL BLOCK

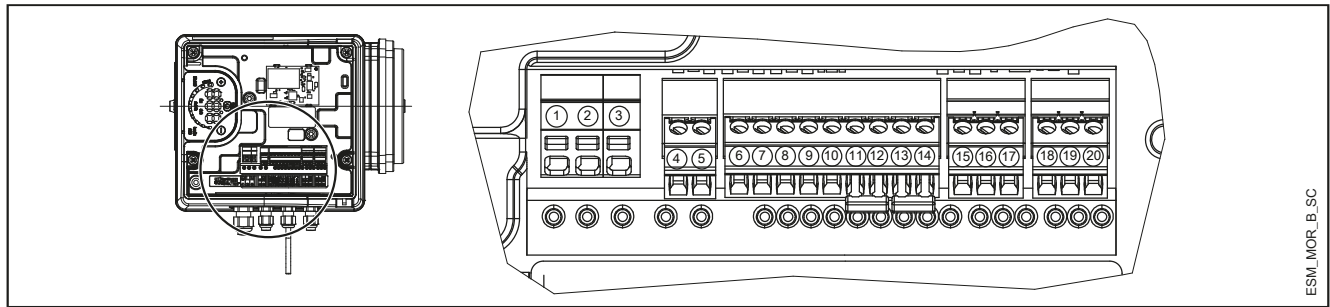

REF.	ITEM	DESCRIPTION
4	Fault Signal	COM - error status relay
5		NO - error status relay
6	Auxiliary Voltage Supply	Auxiliary voltage supply +15 VDC
7	Analog input 0-10V	Actuator mode 0-10 V input
8		GND for 0-10 V input
9	External Pressure sensor [also Differential]	Power supply external sensor +15 VDC
10		External sensor 4-20 mA input
11	External Start/Stop	External ON/OFF input reference
12		External ON/OFF input
13	External Lack of Water	Low water input
14		Low water reference
15	Communication bus	RS485 port 1: RS485-1N B (-)
16		RS485 port 1: RS485-1P A (+)
17		Electronic GND
18	Communication bus	RS485 port 2: RS485 port 2: RS485-2N B (-) active only with optional module
19		RS485 port 2: RS485 port 2: RS485-2P A (+) active only with optional module
20		Electronic GND

### THREE-PHASE TERMINAL BLOCK

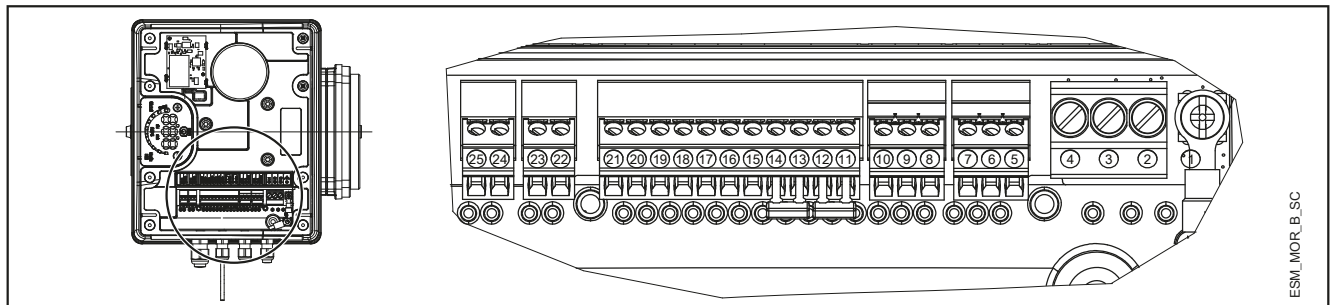

REF.	ITEM	DESCRIPTION
5		Electronic GND
6	Communication bus	RS485 port 1: RS485-1P A (+)
7		RS485 port 1: RS485-1N B (-)
8		Electronic GND
9	Communication bus	RS485 port 2: RS485 port 2: RS485-2P A (+) active only with optional module
10		RS485 port 2: RS485 port 2: RS485-2N B (-) active only with optional module
11	External Lack of Water	Low water reference
12		Low water input
13	External Start/Stop	External ON/OFF input reference
14		External ON/OFF input
15	External Pressure sensor	External sensor 4-20 mA input
16		Power supply external sensor +15 VDC
17	External Pressure sensor [also Differential]	External sensor 4-20 mA input
18		Power supply external sensor +15 VDC
19	Analog input 0-10V	GND for 0-10 V input
20		Actuator mode 0-10 V input
21	Auxiliary Voltage Supply	Auxiliary voltage supply +15 VDC
22	Motor running signal	Normally open contact
23		Common contact
24	Fault Signal	NO - error status relay
25		COM - error status relay

### e-HME SERIES HOW TO READ SMART PUMP SERIES CURVES

To exploit to the maximum potential of Smart Pumps it's important to properly read working curves:

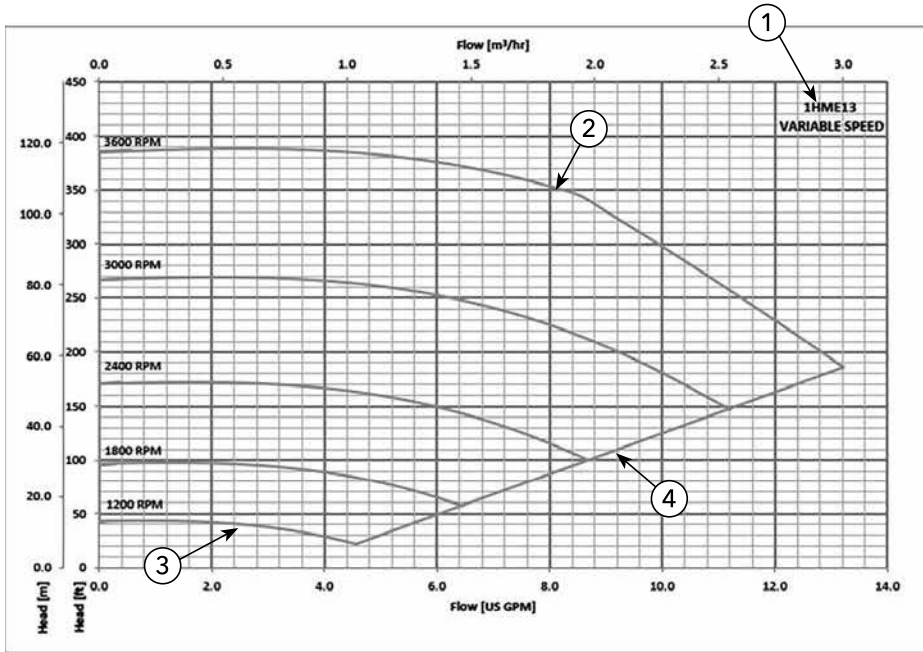

① **Pump model**

② **Maximum speed curve:** equal to 3600 rpm

③ **Minimum speed curve:** it refers to the minimum rpm level the motor is set at 1200 rpm.

④ Each **intermediate curve** between max and min speed shows the speed in rpm the pump+motor+drive system is working at; it's easy to read also from the LED speed bar on the HMI keypad: at 90% there will be 9 LED, at 80% there will be 8 and so on.

Example: at 60% there will be 6 lit LED's

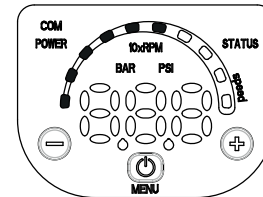
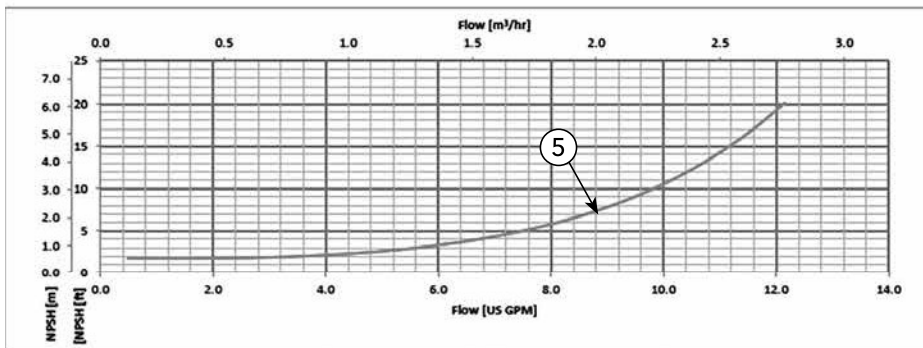

⑤ **NPSH:** is the net positive suction head of pump+motor+drive system working at maximum speed.

⑥ **Wire to Water Efficiency** is the efficiency of pump+motor+drive system working at maximum speed.

⑦ **Pump Efficiency** is the efficiency of the hydraulic part, working at maximum speed.

⑧ **Working point:** it's important to make sure the pump is working at the best working point, the one at highest efficiency.

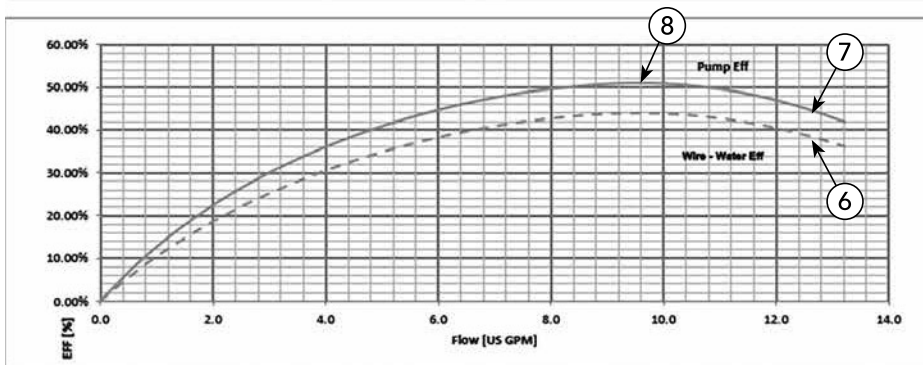

The performances are valid for liquid with density  $\rho = 1 \text{ Kg/dm}^3$  and kinematic viscosity  $\nu = 1 \text{ mm}^2/\text{sec}$ .

It's easy to find it: it's the highest point of the hp pump efficiency curve; once you found it, you can read flow values from x-axis and head values from y-axis which allow the system to work at the best working point.

### e-HME SERIES - SINGLE-PHASE VERSION

PUMP TYPE HME..N Single-Phase	MOTOR		PUMP	
	P <sub>N</sub> (HP)	Type 1 x 208-240 V	* P1 (kW) 1 x 208-240 V	I (A) 1 x 208-240 V
1HME04N03MM1	0.5	ESM80/103 HM..	0.49	2.3 - 2.0
1HME06N05MM1	0.75	ESM80/105 HM..	0.69	3.3 - 2.9
1HME09N07MM1	1.0	ESM80/107 HM..	0.91	4.4 - 3.8
1HME13N11MM1	1.5	ESM80/111 HM..	1.33	6.2 - 5.3
1HME18N15MM1	2.0	ESM80/115 HM..	1.77	8.4 - 7.3

PUMP TYPE HME..N Single-Phase	MOTOR		PUMP	
	P <sub>N</sub> (HP)	Type 1 x 208-240 V	* P1 (kW) 1 x 208-240 V	I (A) 1 x 208-240 V
3HME02N03MM1	0.5	ESM80/103 HM..	0.44	2.1 - 1.8
3HME04N05MM1	0.75	ESM80/105 HM..	0.69	3.3 - 2.9
3HME05N07MM1	1.0	ESM80/107 HM..	0.91	4.4 - 3.8
3HME08N15MM1	2.0	ESM80/115 HM..	1.54	7.5 - 6.4
3HME10N15MM1	2.0	ESM80/115 HM..	1.77	8.4 - 7.3

PUMP TYPE HME..N Single-Phase	MOTOR		PUMP	
	P <sub>N</sub> (HP)	Type 1 x 208-240 V	* P1 (kW) 1 x 208-240 V	I (A) 1 x 208-240 V
5HME02N05MM1	0.75	ESM80/105 HM..	0.69	3.3 - 2.9
5HME03N07MM1	1.0	ESM80/107 HM..	0.91	4.4 - 3.8
5HME05N15MM1	2.0	ESM80/115 HM..	1.61	7.8 - 6.7
5HME06N15MM1	2.0	ESM80/115 HM..	1.77	8.4 - 7.3

PUMP TYPE HME..N Single-Phase	MOTOR		PUMP	
	P <sub>N</sub> (HP)	Type 1 x 208-240 V	* P1 (kW) 1 x 208-240 V	I (A) 1 x 208-240 V
10HME01N07MM1	1.0	ESM80/107 HM..	0.86	4.2 - 3.6
10HME02N15MM1	2.0	ESM80/115 HM..	1.64	7.9 - 6.8

PUMP TYPE HME..N Single-Phase	MOTOR		PUMP	
	P <sub>N</sub> (HP)	Type 1 x 208-240 V	* P1 (kW) 1 x 208-240 V	I (A) 1 x 208-240 V
15HME01N15MM1	2.0	ESM80/115 HM..	1.64	7.9 - 6.8

\* Maximum value in specified range; P<sub>N</sub> = HP Rating; P1 = input power; I = input current.

### e-HME SERIES - THREE-PHASE VERSION

PUMP TYPE HME..N Three-Phase	MOTOR		PUMP		
	P <sub>N</sub> (HP)	Type	* P1 (kW)	I (A) 208-240 V	I (A) 380-460 V
1HME04N03TM2	0.5	ESM80/303 HM..	0.51	2.3 - 2.0	1.6 - 1.4
1HME06N05TM2	0.75	ESM80/305 HM..	0.68	2.9 - 2.5	1.9 - 1.7
1HME09N07TM2	1.0	ESM80/307 HM..	0.9	3.7 - 3.3	2.4 - 2.2
1HME13N11TM2	1.5	ESM80/311 HM..	1.34	5.2 - 4.7	3.5 - 3.1
1HME18N15TM2	2.0	ESM80/315 HM..	1.78	6.7 - 6.1	4.5 - 4.0

PUMP TYPE HME..N Three-Phase	MOTOR		PUMP		
	P <sub>N</sub> (HP)	Type	* P1 (kW)	I (A) 208-240 V	I (A) 380-460 V
3HME02N03TM2	0.5	ESM80/303 HM..	0.44	2.1 - 1.8	1.5 - 1.4
3HME04N05TM2	0.75	ESM80/305 HM..	0.68	2.9 - 2.5	1.9 - 1.7
3HME05N07TM2	1.0	ESM80/307 HM..	0.9	3.7 - 3.3	2.4 - 2.2
3HME08N15TM2	2.0	ESM80/315 HM..	1.6	6.0 - 5.5	4.0 - 3.6
3HME10N15TM2	2.0	ESM80/315 HM..	1.78	6.7 - 6.1	4.5 - 4.0
3HME14N22TM4	3.0	ESM80/322 HM..	2.55		5.9 - 5.2

PUMP TYPE HME..N Three-Phase	MOTOR		PUMP		
	P <sub>N</sub> (HP)	Type	* P1 (kW)	I (A) 208-240 V	I (A) 380-460 V
5HME02S03TM2	0.75	ESM80/305 HM..	0.68	2.9 - 2.5	1.9 - 1.7
5HME03N07TM2	1.0	ESM80/307 HM..	0.9	3.7 - 3.3	2.4 - 2.2
5HME05N15TM2	2.0	ESM80/315 HM..	1.71	6.3 - 5.7	4.2 - 3.7
5HME06N15TM2	2.0	ESM80/315 HM..	1.78	6.7 - 6.1	4.5 - 4.0
5HME09N22TM4	3.0	ESM80/322 HM..	2.55		5.9 - 5.2

PUMP TYPE HME..N Three-Phase	MOTOR		PUMP		
	P <sub>N</sub> (HP)	Type	* P1 (kW)	I (A) 208-240 V	I (A) 380-460 V
10HME01N07TM2	1.0	ESM80/307 HM..	0.87	3.6 - 3.2	2.3 - 2.1
10HME02N15TM2	2.0	ESM80/315 HM..	1.67	6.3 - 5.7	4.2 - 3.7
10HME03N22TM4	3.0	ESM80/322 HM..	2.34		5.4 - 4.8

PUMP TYPE HME..N Three-Phase	MOTOR		PUMP		
	P <sub>N</sub> (HP)	Type	* P1 (kW)	I (A) 208-240 V	I (A) 380-460 V
15HME01N15TM2	2.0	ESM80/315 HM..	1.67	6.3 - 5.7	4.2 - 3.7
15HME02N22TM4	3.0	ESM80/322 HM..	2.55		5.9 - 5.2

\* Maximum value in specified range; P<sub>N</sub> = HP Rating; P1 = input power; I = input current.



## Commercial Water

### e-HME SERIES - ELECTRICAL DATA TABLE

The nominal motor power is guaranteed in the 3000-3600 rpm range. The motor is automatically limited to 3600 rpm maximum; the motor works partially loaded below 3000 rpm.

#### SINGLE-PHASE VERSION

PN HP	MOTOR TYPE	IEC SIZE	Construction Design	SPEED (RPM)* min-1	INPUT CURRENT I (A) 208-240 V	DATA RELATED TO 230V					
						In A	Power Factor / cos φ	Tn lb.ft	Efficiency η %		
									100	75	50
0.50	ESM80/103 HM..	80	SPECIAL	3000	2.28-1.99	2.08	0.95	0.87	81.3	79.1	74.3
				3600	2.30-2.02	2.10		0.72	80.6	77.5	72.0
0.75	ESM80/105 HM..			3000	3.27-2.85	2.96	0.97	1.29	83.3	82.2	78.8
				3600	3.27-2.85	2.96		1.08	83.3	81.5	77.5
1.0	ESM80/107 HM..			3000	4.43-3.84	4.00	0.98	1.76	83.3	83.3	81.5
				3600	4.38-3.79	3.94		1.47	84.5	83.5	80.6
1.5	ESM80/111 HM..			3000	6.26-5.35	5.64	0.99	2.58	85.7	85.1	82.7
				3600	6.20-5.32	5.63		2.15	85.9	84.6	81.4
2.0	ESM80/115 HM..			3000	8.57-7.32	7.69	0.99	3.52	85.6	85.7	84.7
				3600	8.42-7.25	7.62		2.94	86.3	85.9	84.0

\* The indicated rotational speeds represent the upper and lower limits of the speed range for rated power.

#### THREE-PHASE VERSION

PN HP	MOTOR TYPE	IEC SIZE	Construction Design	SPEED (RPM)* min-1	INPUT CURRENT I (A) 208-240/380- 460 V	DATA RELATED TO 460V					
						In A	Power Factor / cos φ	Tn lb.ft	Efficiency η %		
									100	75	50
0.50	ESM80/303 HM..	80	SPECIAL	3000	2.01-1.85/1.41-1.28	1.42	0.48	0.87	78.6	75.6	70.1
				3600	2.13-1.83/1.43-1.33	1.36		0.72	83.1	80.7	76.1
0.75	ESM80/305 HM..			3000	2.81-2.57/1.89-1.69	1.88	0.52	1.29	81.1	79.3	75.5
				3600	2.90-2.52/1.90-1.73	1.80		1.08	85.4	83.8	80.6
1.0	ESM80/307 HM..			3000	3.70-3.37/2.44-2.17	2.41	0.55	1.76	81.9	81.2	78.6
				3600	3.74-3.28/2.43-2.20	2.31		1.47	86.1	85.5	83.1
1.5	ESM80/311 HM..			3000	5.12-4.73/3.41-3.01	3.35	0.57	2.58	82.8	81.3	77.7
				3600	5.15-4.69/3.45-3.06	3.32		2.15	83.5	81.6	77.6
2.0	ESM80/315 HM..			3000	6.73-6.17/4.49-3.95	4.39	0.59	3.52	83.1	82.8	80.6
				3600	6.69-6.08/4.48-3.97	4.32		2.94	84.6	83.6	80.8
3.0	ESM80/322 HM..			3000	- /6.03-5.32	5.81	0.62	5.16	87.6	87.4	85.9
				3600	- /5.93-5.24	4.31		5.84	88.9	88.2	86.3

\* The indicated rotational speeds represent the upper and lower limits of the speed range for rated power.

### 1, 3, 5HME..N SERIES - SINGLE-PHASE VERSION DIMENSIONS AND WEIGHTS

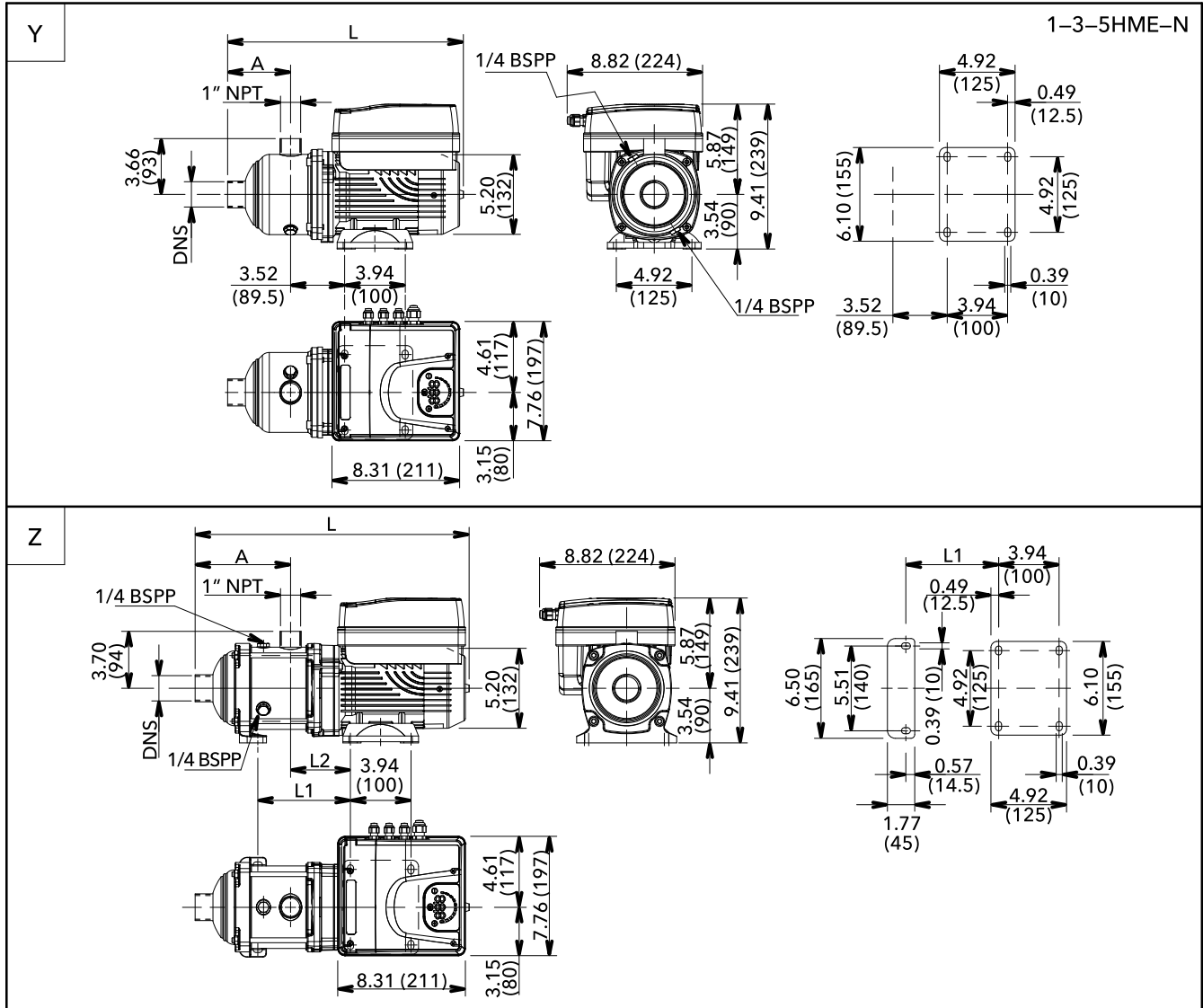

Pump Size Stages	Phase	DWG No.	Motor		Dimensions (in)					Maximum Working Pressure (PSI)	Weight (lbs)
			HP	IEC Frame Size	A	DNS	L	L1	L2		
1HME04N03MM1	SINGLE-PHASE	y	0.5	80	4.21	1" NPT	15.51	-	-	145	20
1HME06N05MM1			0.75	80	5.79	1" NPT	17.07	-	-	145	22
1HME09N07MM1		z	1.0	80	7.52	1" NPT	19.17	7.40	3.90	232	26
1HME13N11MM1			1.5	80	10.67	1" NPT	22.32	10.55	3.90	232	31
1HME18N15MM1			2.0	80	14.61	1" NPT	26.26	14.49	3.90	232	35
3HME02N03MM1	SINGLE-PHASE	y	0.5	80	3.43	1" NPT	14.72	-	-	145	20
3HME04N05MM1			0.75	80	4.21	1" NPT	15.51	-	-	145	20
3HME05N07MM1			1.0	80	5.00	1" NPT	16.28	-	-	145	22
3HME08N15MM1		z	2.0	80	6.73	1" NPT	18.39	6.61	3.90	232	29
3HME10N15MM1			2.0	80	8.31	1" NPT	19.96	8.19	3.90	232	31
5HME02N05MM1	SINGLE-PHASE	y	0.75	80	4.09	1 1/4" NPT	15.37	-	-	145	20
5HME03N07MM1			1.0	80	4.09	1 1/4" NPT	15.37	-	-	145	20
5HME05N15MM1			2.0	80	6.06	1 1/4" NPT	17.34	-	-	145	22
5HME06N15MM1		z	2.0	80	6.22	1 1/4" NPT	17.87	6.02	3.90	232	26

## Commercial Water

### 1, 3, 5HME..N SERIES - THREE-PHASE VERSION DIMENSIONS AND WEIGHTS

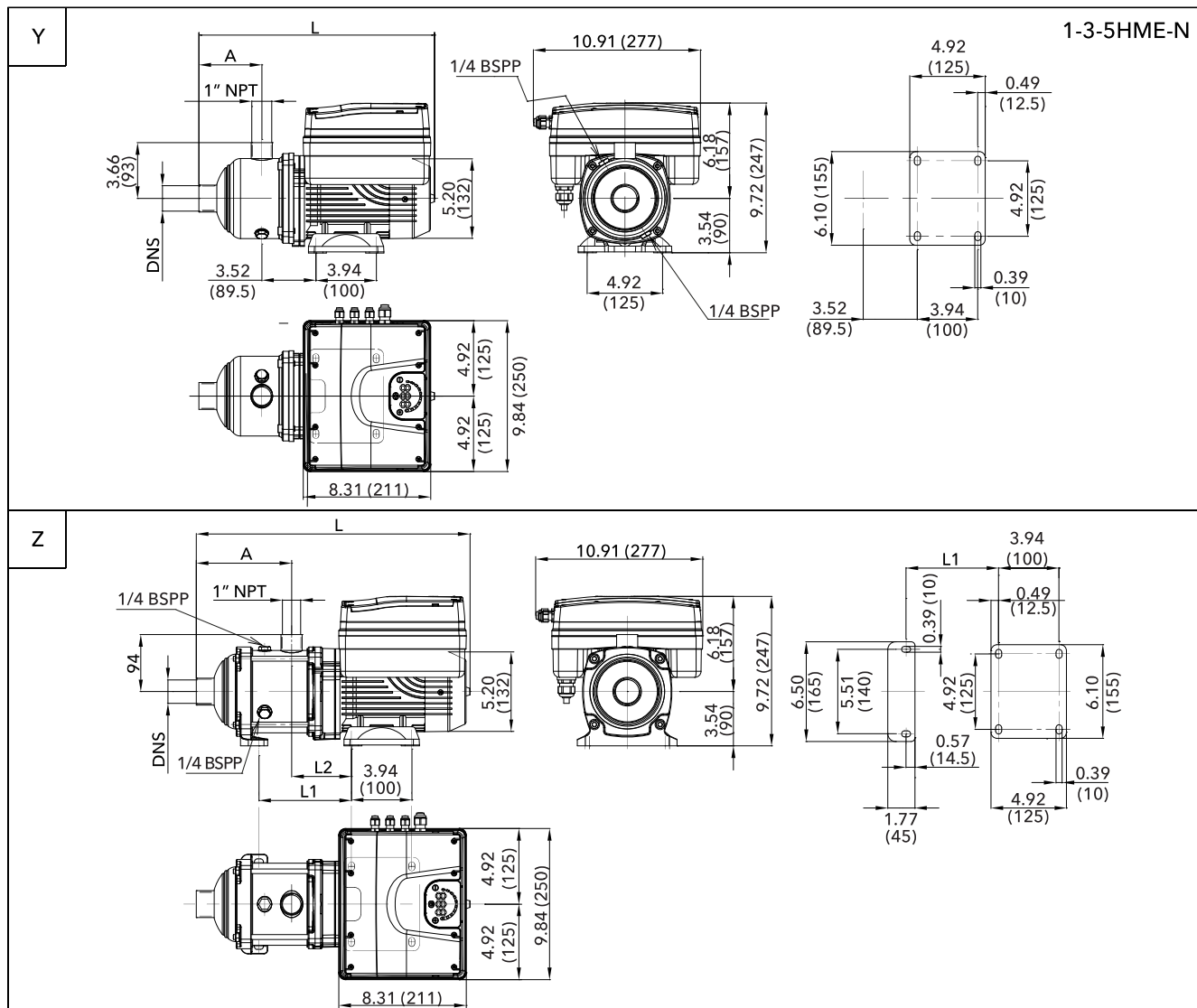

Pump Size Stages	Phase	DWG No.	Motor		Dimensions (in)					Maximum Working Pressure (PSI)	Weight (lbs)
			HP	IEC Frame Size	A	DNS	L	L1	L2		
1HME04N03TM2	THREE-PHASE	y	0.5	80	4.21	1" NPT	15.51	-	-	145	33
1HME06N05TM2			0.75	80	5.79	1" NPT	17.07	-	-	145	35
1HME09N07TM2		z	1.0	80	7.52	1" NPT	19.17	7.40	3.90	232	40
1HME13N11TM2			1.5	80	10.67	1" NPT	22.32	10.55	3.90	232	42
1HME18N15TM2			2.0	80	14.61	1" NPT	26.26	14.49	3.90	232	49
3HME02N03TM2	THREE-PHASE	y	0.5	80	3.43	1" NPT	14.72	-	-	145	33
3HME04N05TM2			0.75	80	4.21	1" NPT	15.51	-	-	145	33
3HME05N07TM2			1.0	80	5.00	1" NPT	16.28	-	-	145	33
3HME08N15TM2		z	2.0	80	6.73	1" NPT	18.39	6.61	3.90	232	42
3HME10N15TM2			2.0	80	8.31	1" NPT	19.96	8.19	3.90	232	42
3HME14N22TM4	3.0	80	11.46	1" NPT	23.11	11.34	3.90	232	49		
5HME02N05TM2	THREE-PHASE	y	0.8	80	4.09	1 1/4" NPT	15.37	-	-	145	33
5HME03N07TM2			1.0	80	4.09	1 1/4" NPT	15.37	-	-	145	33
5HME05N15TM2			2.0	80	6.06	1 1/4" NPT	17.34	-	-	145	35
5HME06N15TM2		z	2.0	80	6.22	1 1/4" NPT	17.87	6.02	3.90	232	37
5HME09N22TM4			3.0	80	9.17	1 1/4" NPT	20.83	8.98	3.90	232	42

## Commercial Water

### 1HME..N SERIES OPERATING CHARACTERISTICS

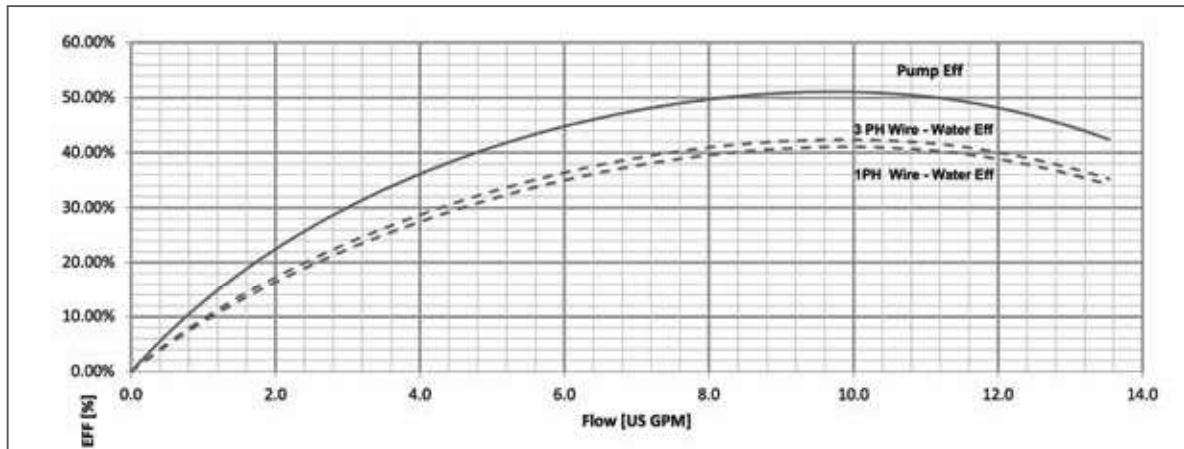
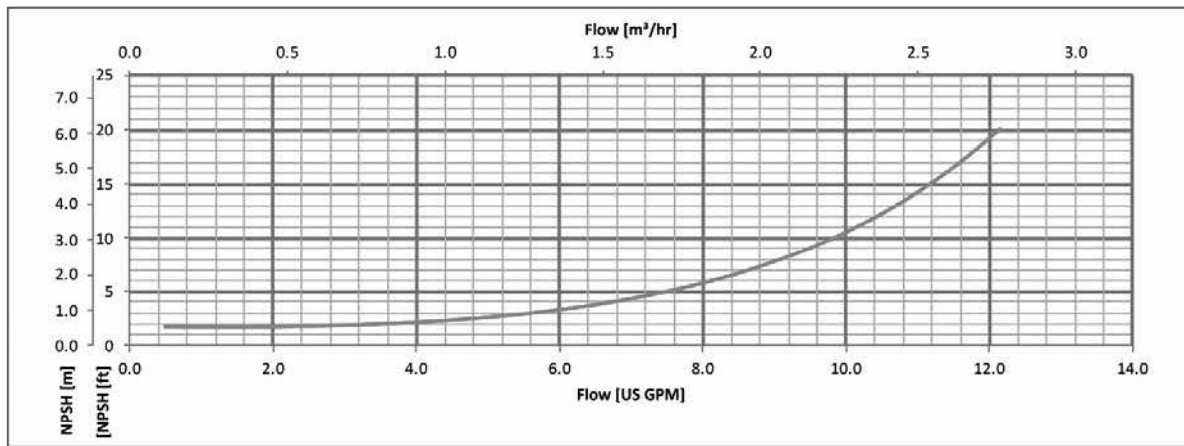
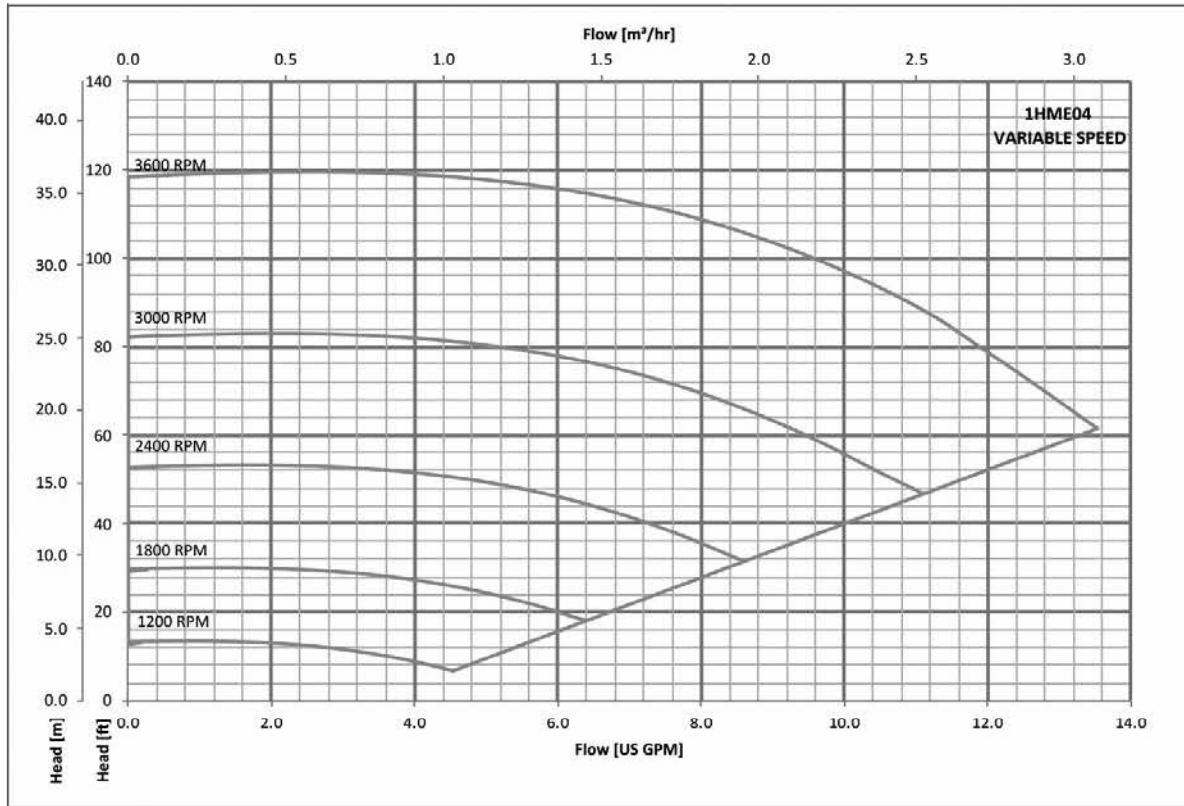

The performances are valid for liquid with density  $\rho = 1 \text{ Kg/dm}^3$  and kinematic viscosity  $\nu = 1 \text{ mm}^2/\text{sec}$ .

## Commercial Water

### 1HME..N SERIES OPERATING CHARACTERISTICS

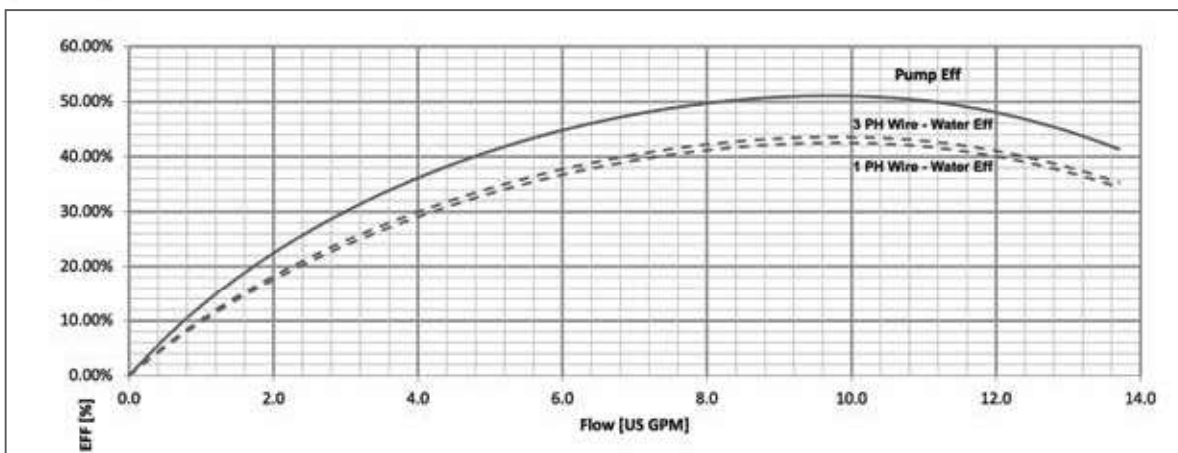
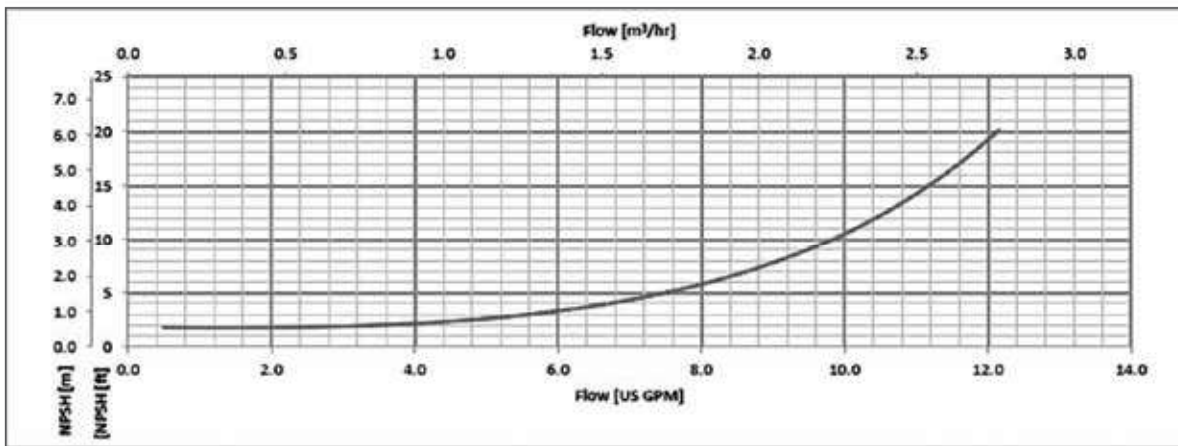
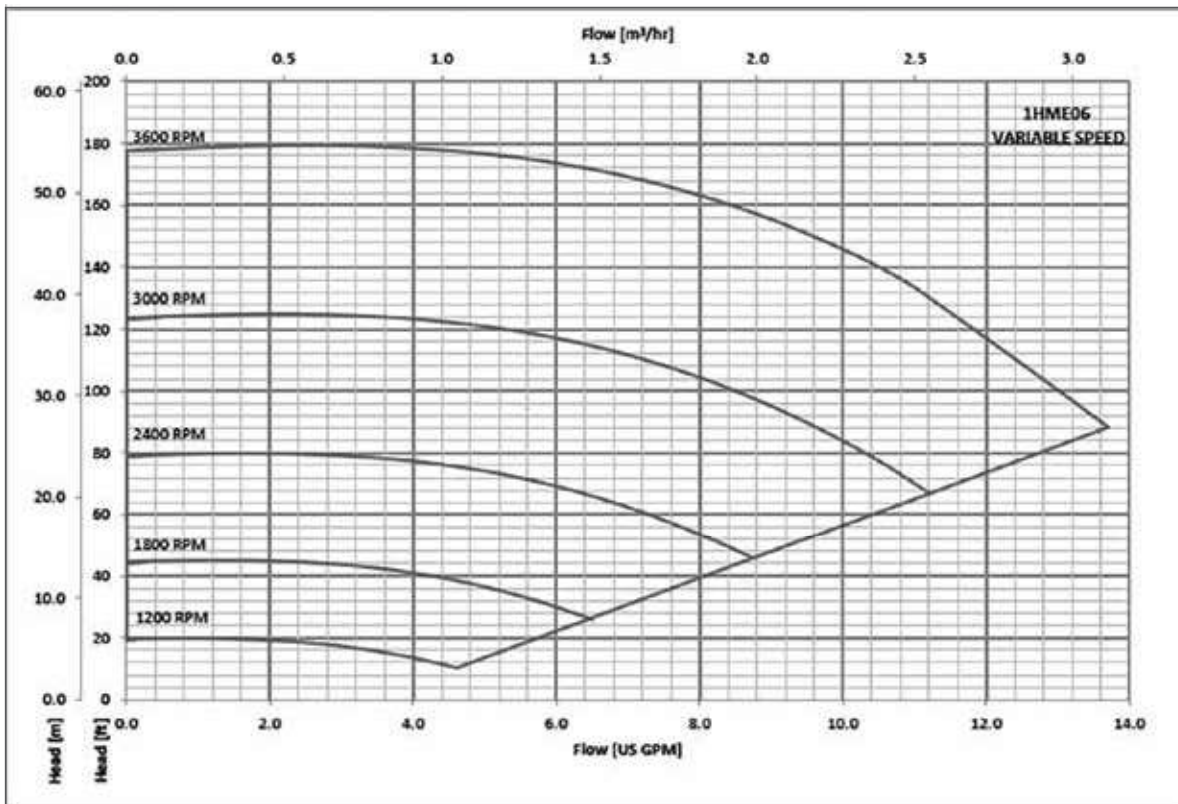

The performances are valid for liquid with density  $\rho = 1 \text{ Kg/dm}^3$  and kinematic viscosity  $\nu = 1 \text{ mm}^2/\text{sec}$ .

### 1HME..N SERIES OPERATING CHARACTERISTICS

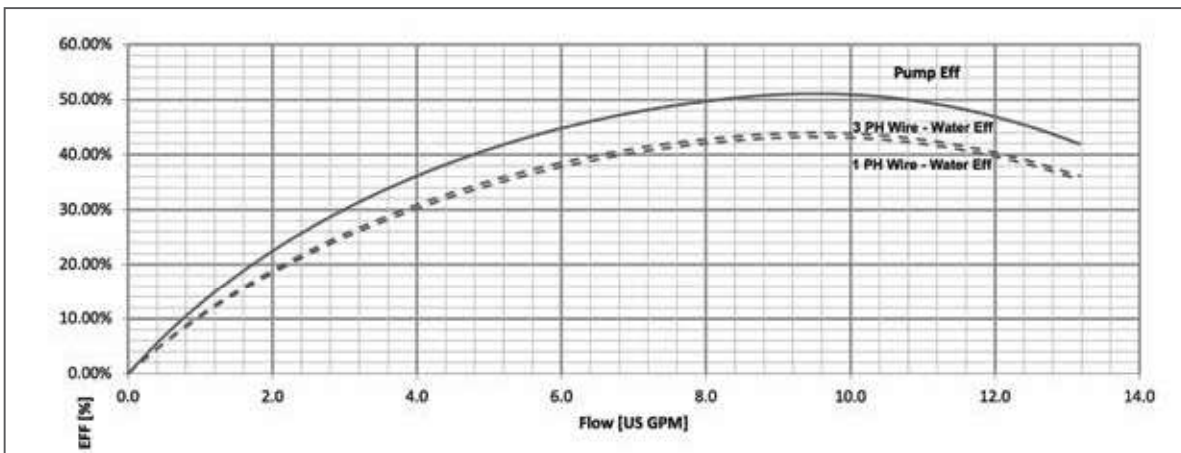
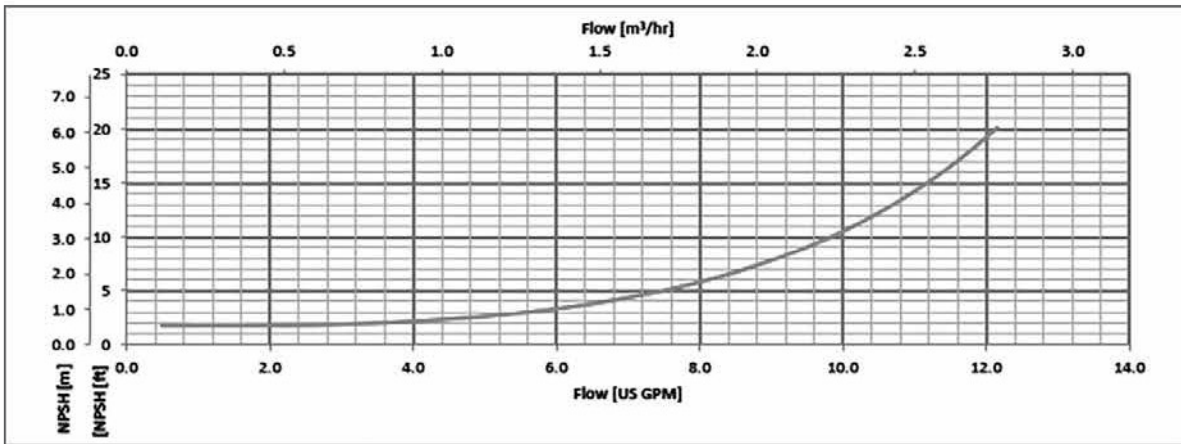
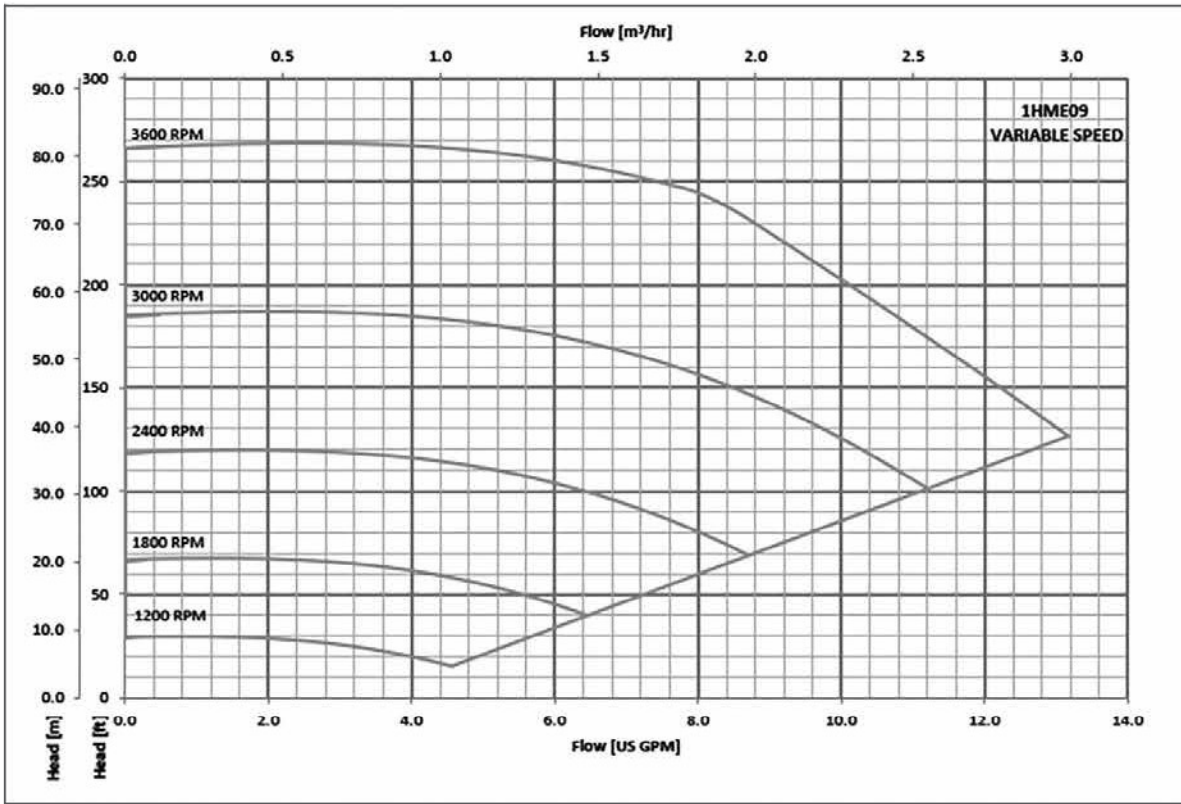

The performances are valid for liquid with density  $\rho = 1 \text{ Kg/dm}^3$  and kinematic viscosity  $\nu = 1 \text{ mm}^2/\text{sec}$ .

## Commercial Water

### 1HME..N SERIES OPERATING CHARACTERISTICS

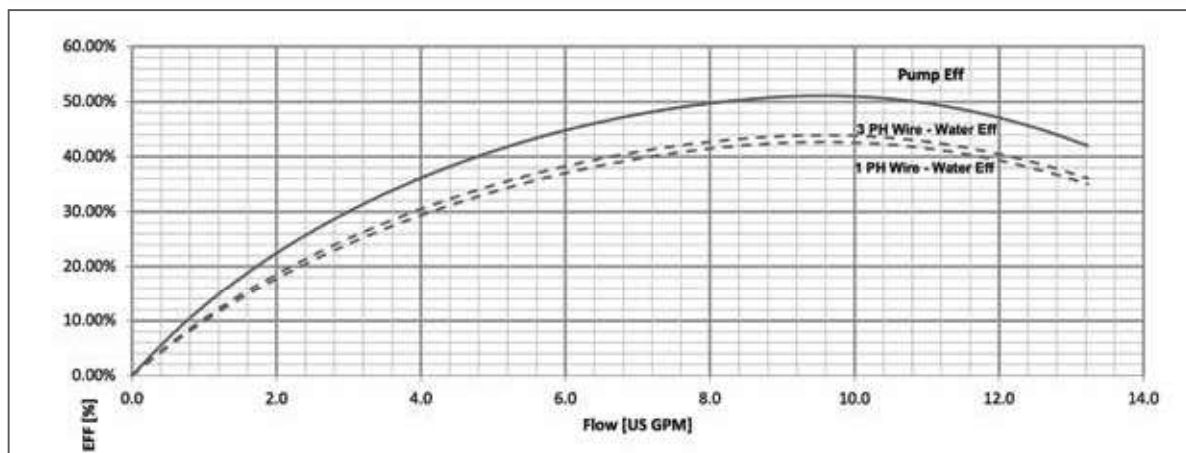
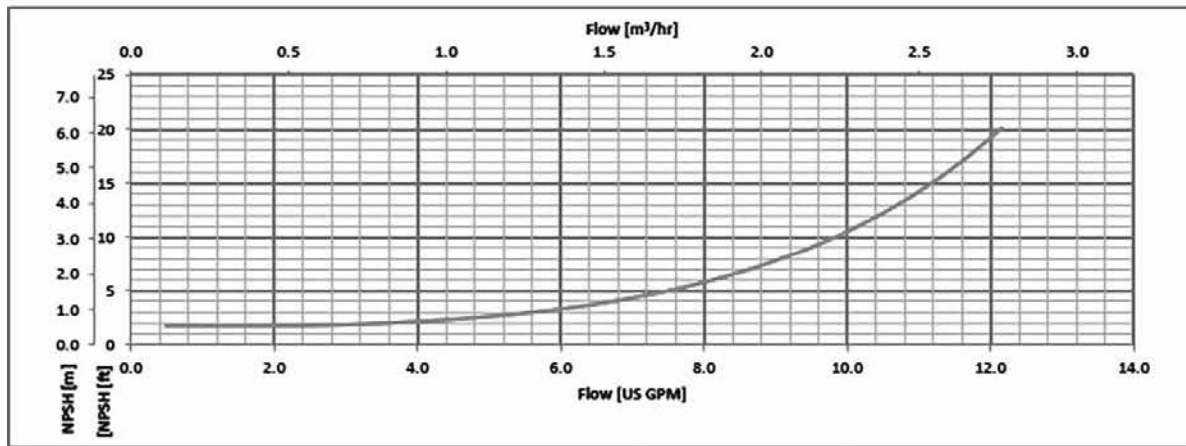
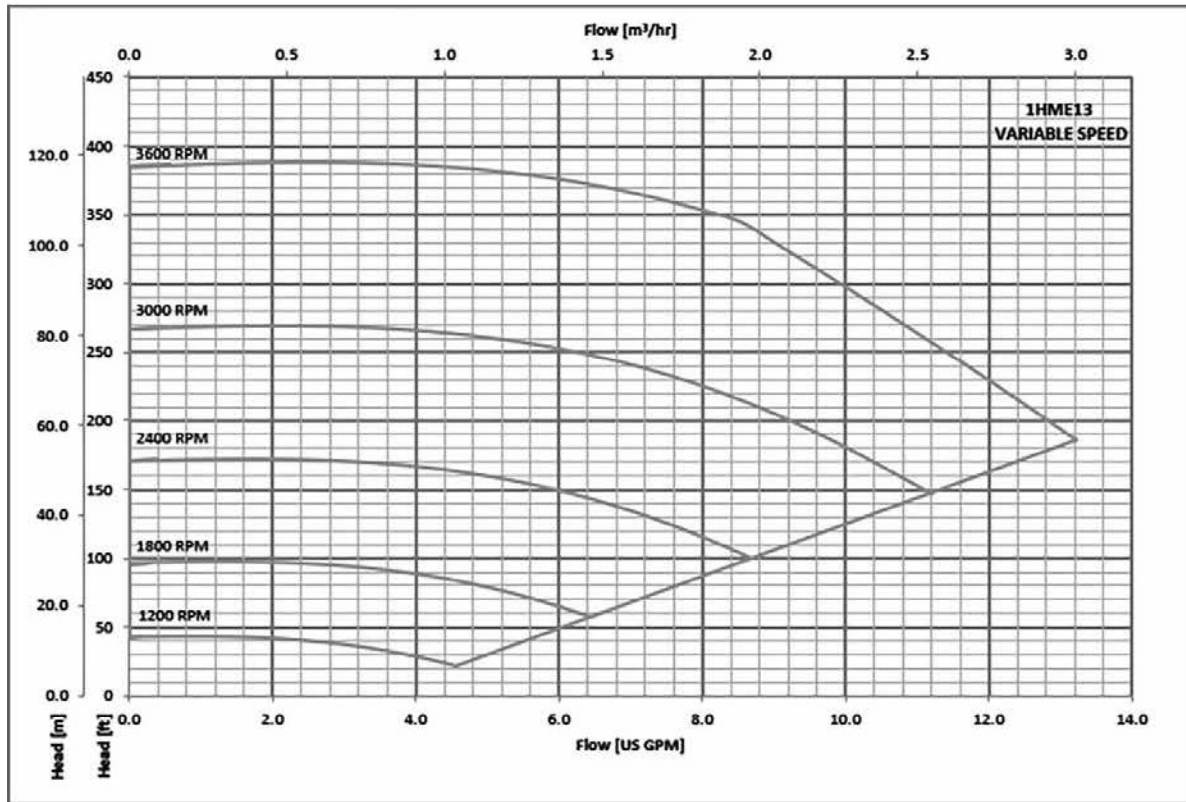

The performances are valid for liquid with density  $\rho = 1 \text{ Kg/dm}^3$  and kinematic viscosity  $\nu = 1 \text{ mm}^2/\text{sec}$ .

### 1HME..N SERIES OPERATING CHARACTERISTICS

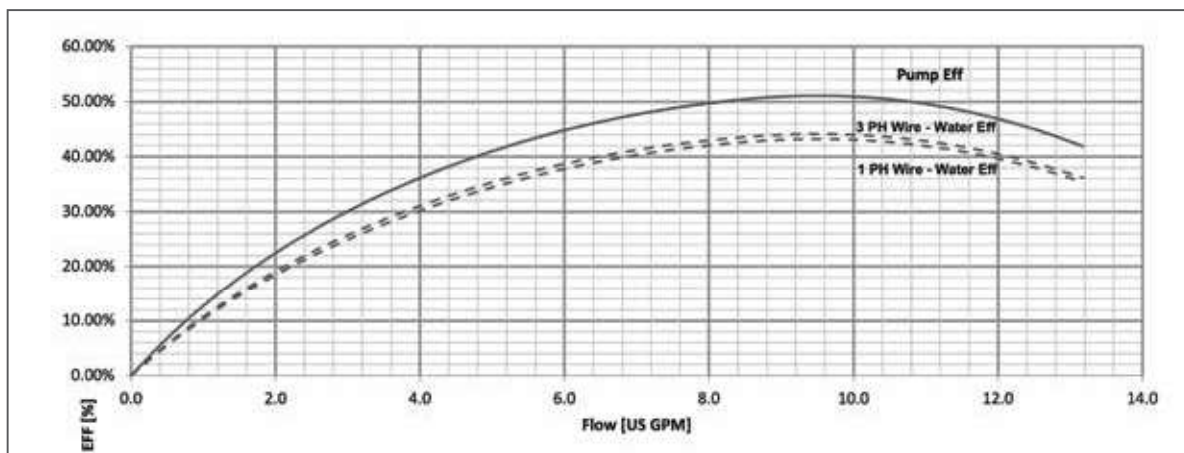
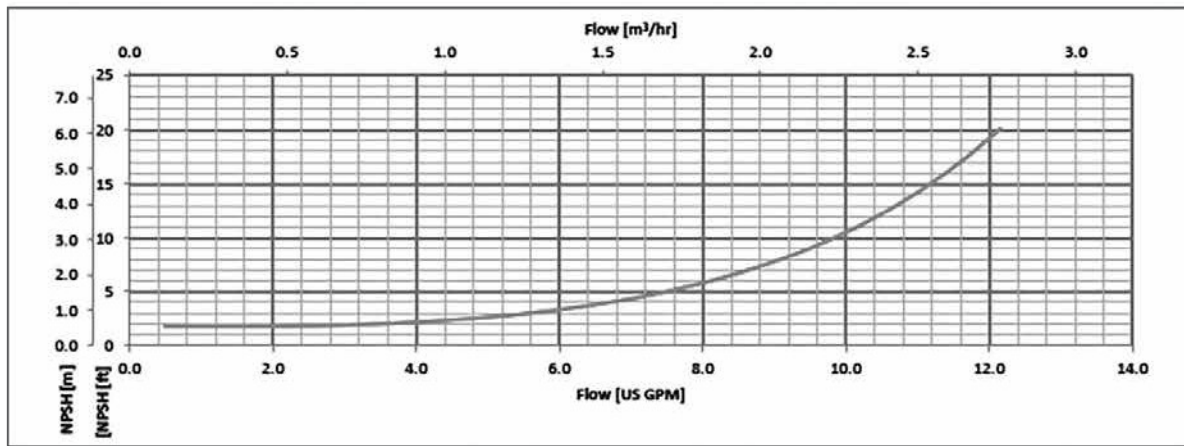
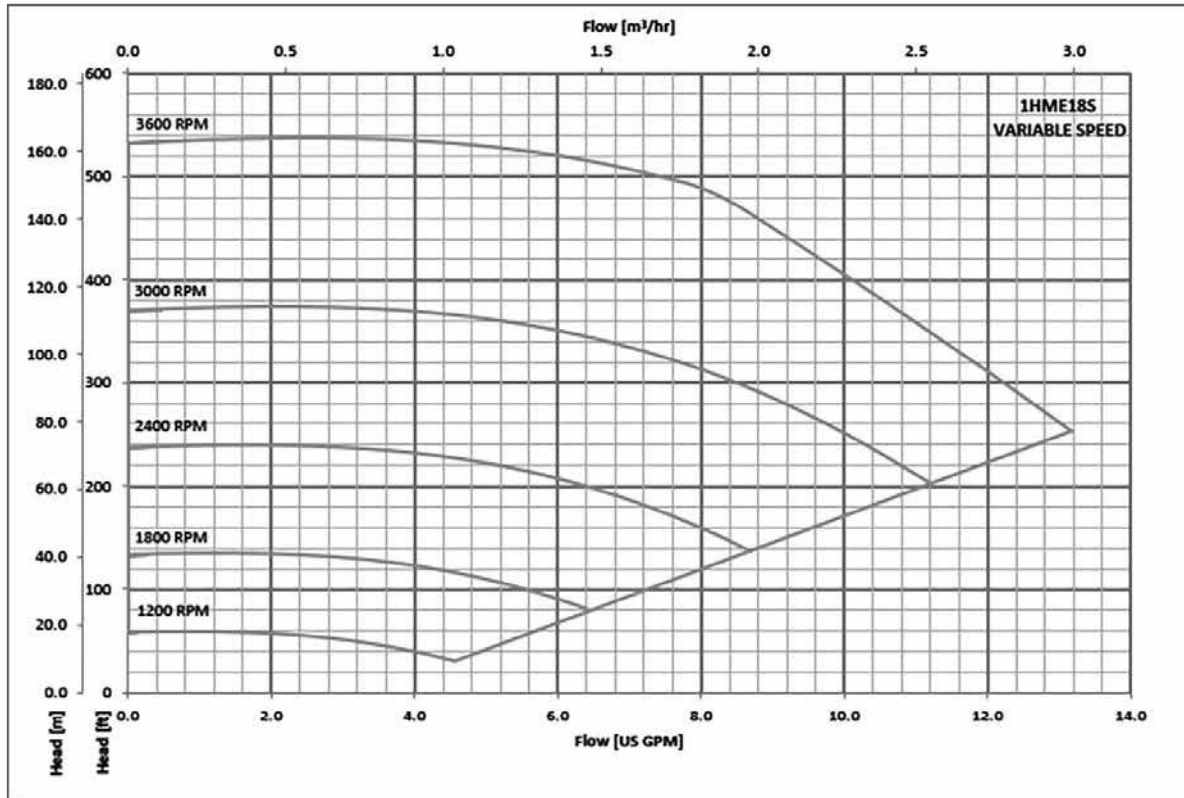

The performances are valid for liquid with density  $\rho = 1 \text{ Kg/dm}^3$  and kinematic viscosity  $\nu = 1 \text{ mm}^2/\text{sec}$ .



## Commercial Water

### 3HME..N SERIES OPERATING CHARACTERISTICS

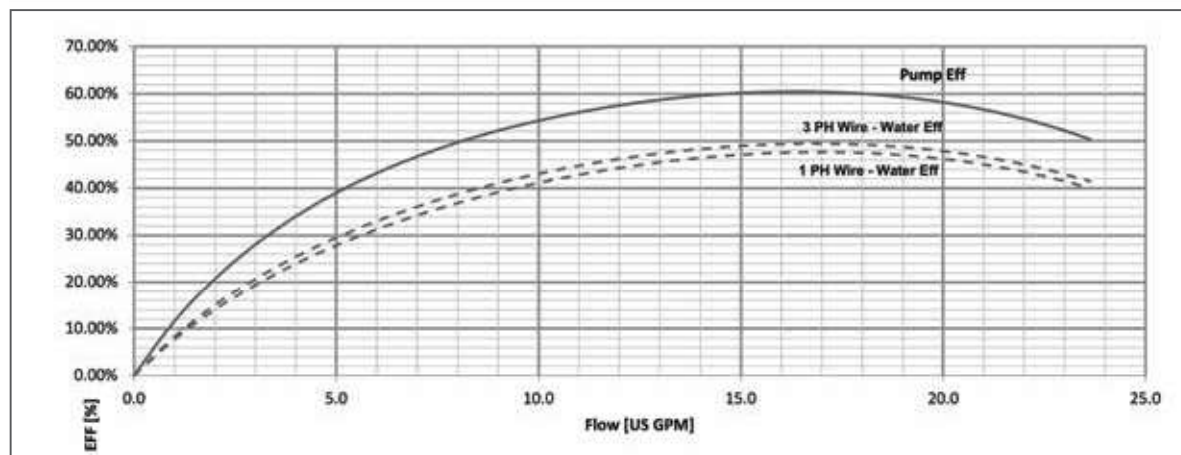
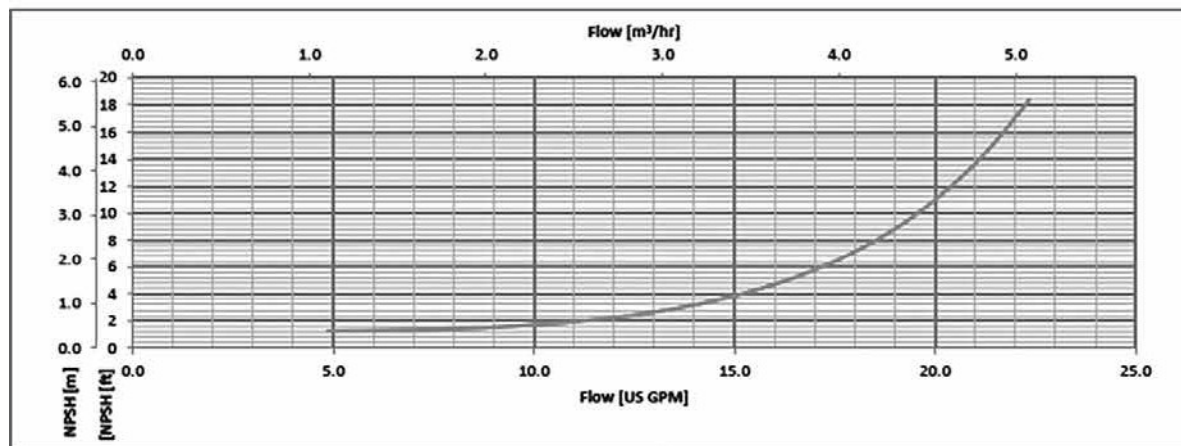
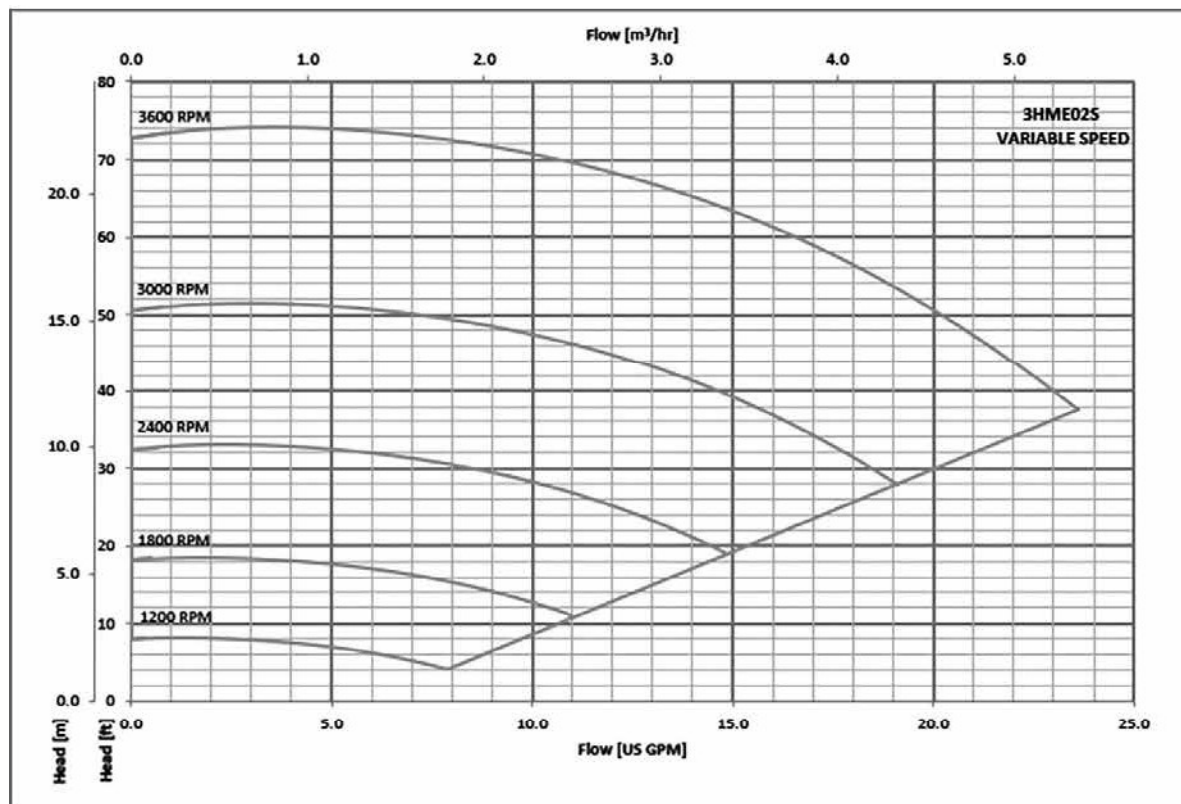

The performances are valid for liquid with density  $\rho = 1 \text{ Kg/dm}^3$  and kinematic viscosity  $\nu = 1 \text{ mm}^2/\text{sec}$ .

### 3HME..N SERIES OPERATING CHARACTERISTICS

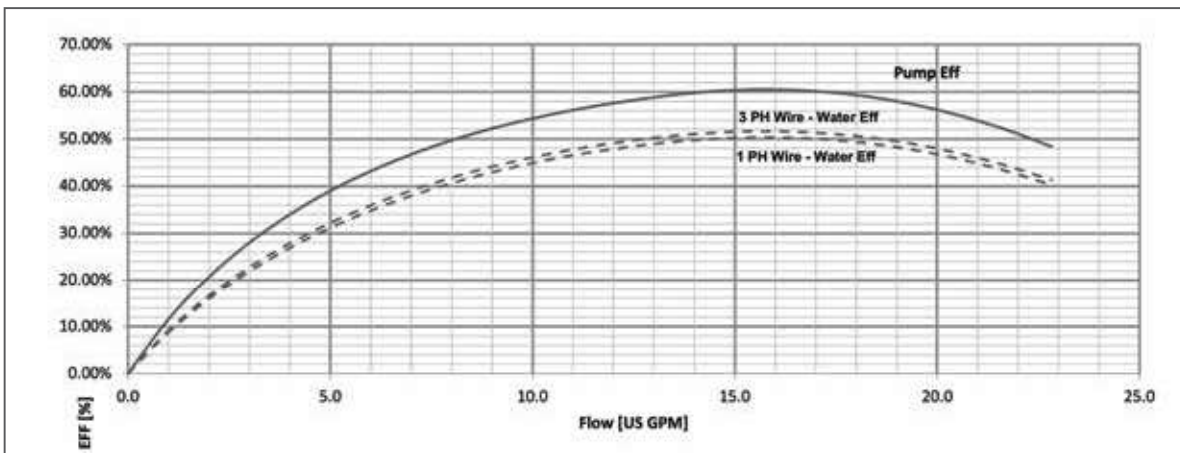
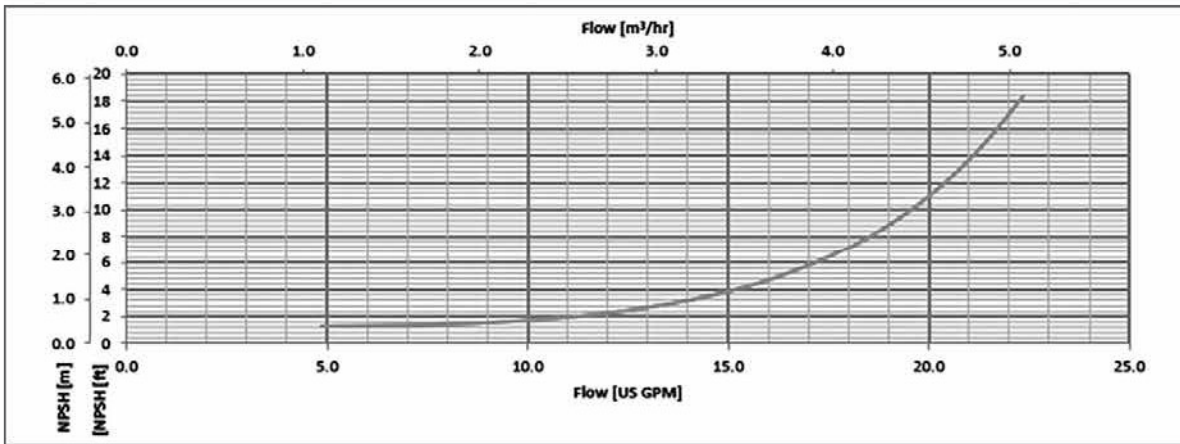
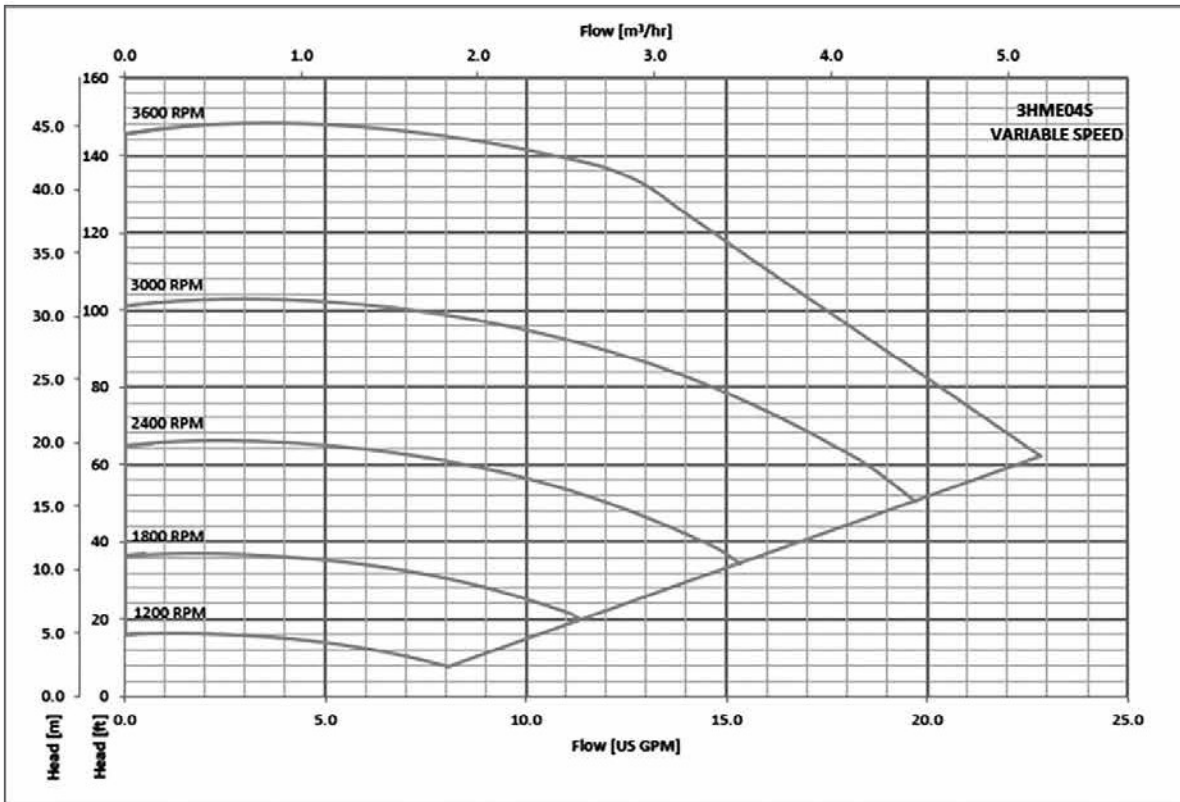

The performances are valid for liquid with density  $\rho = 1 \text{ Kg/dm}^3$  and kinematic viscosity  $\nu = 1 \text{ mm}^2/\text{sec}$ .

## Commercial Water

### 3HME..N SERIES OPERATING CHARACTERISTICS

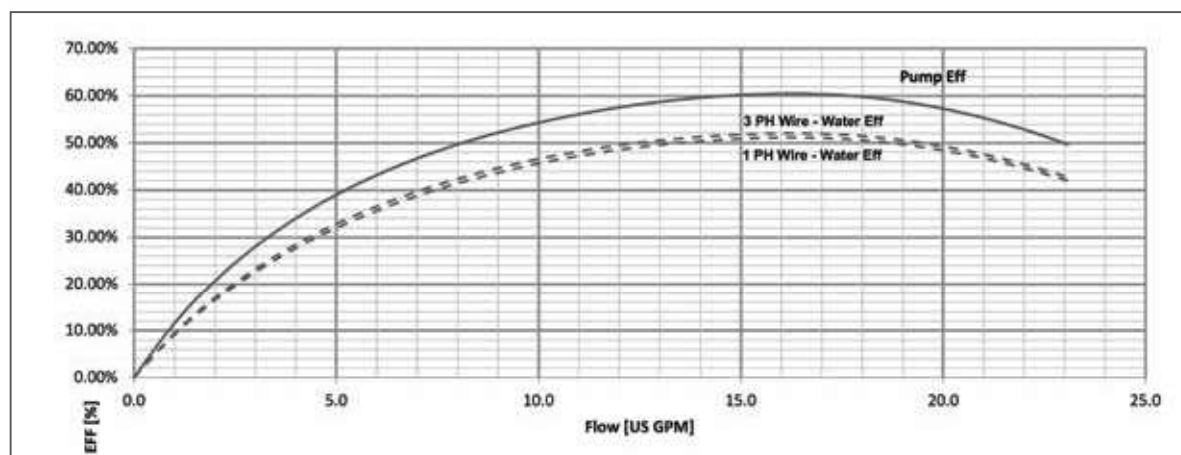
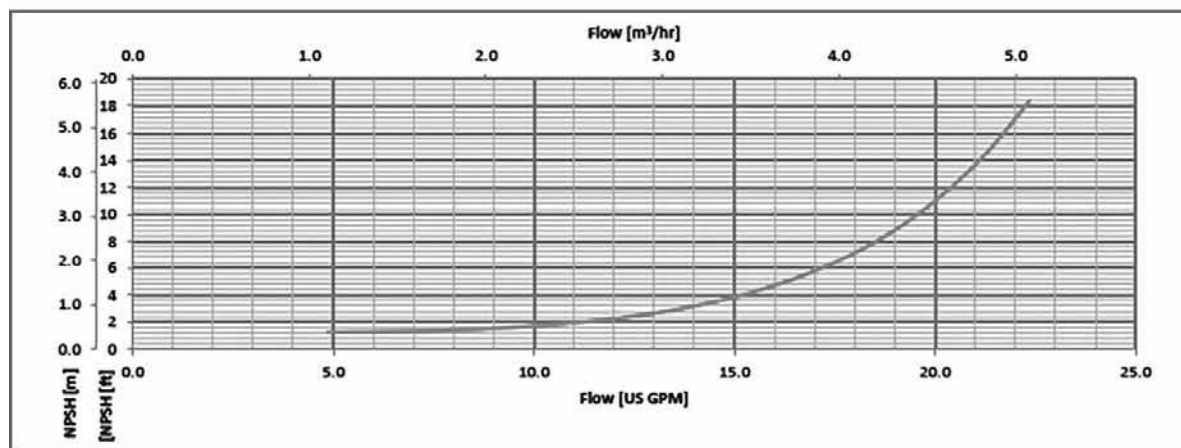
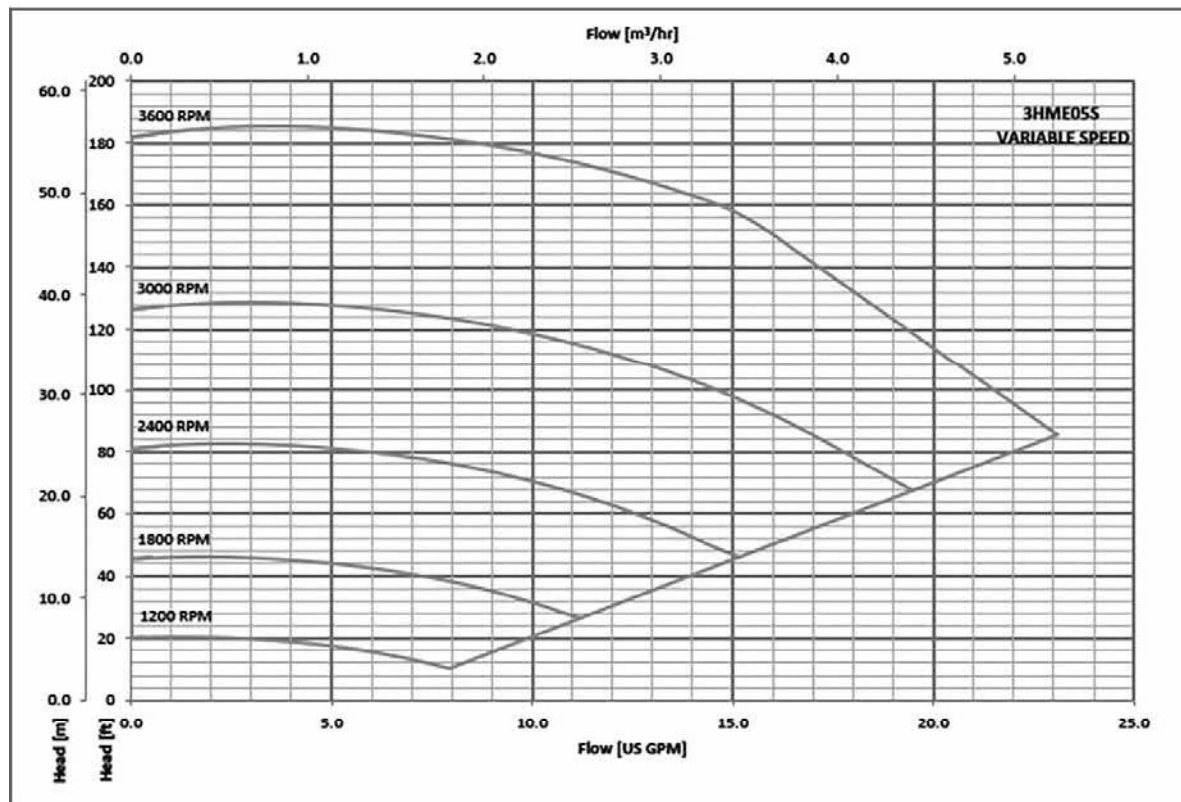

The performances are valid for liquid with density  $\rho = 1 \text{ Kg/dm}^3$  and kinematic viscosity  $\nu = 1 \text{ mm}^2/\text{sec}$ .

### 3HME..N SERIES OPERATING CHARACTERISTICS

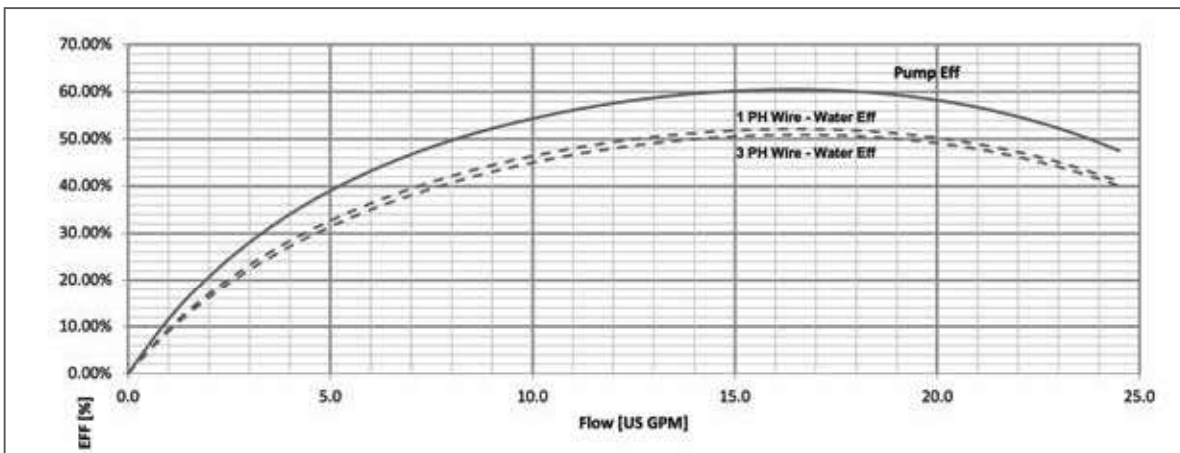
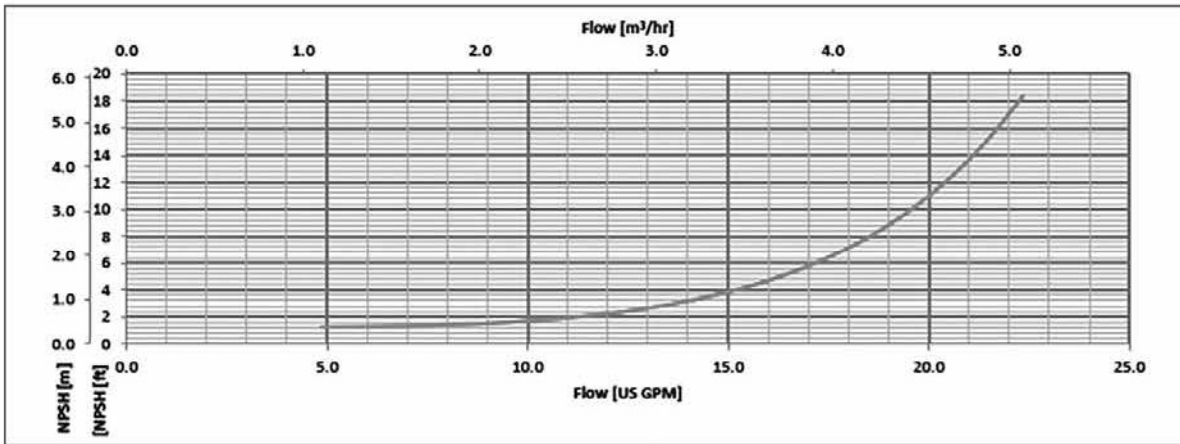
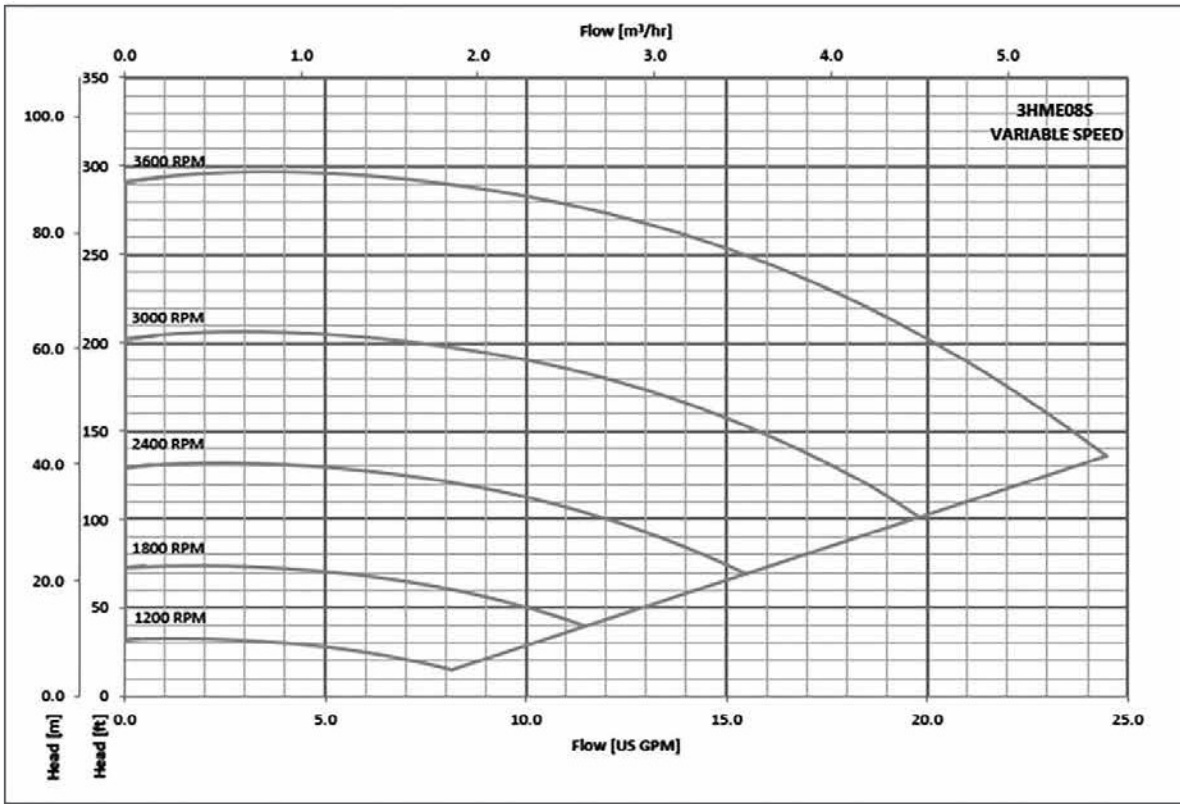

The performances are valid for liquid with density  $\rho = 1 \text{ Kg/dm}^3$  and kinematic viscosity  $\nu = 1 \text{ mm}^2/\text{sec}$ .

### 3HME..N SERIES OPERATING CHARACTERISTICS

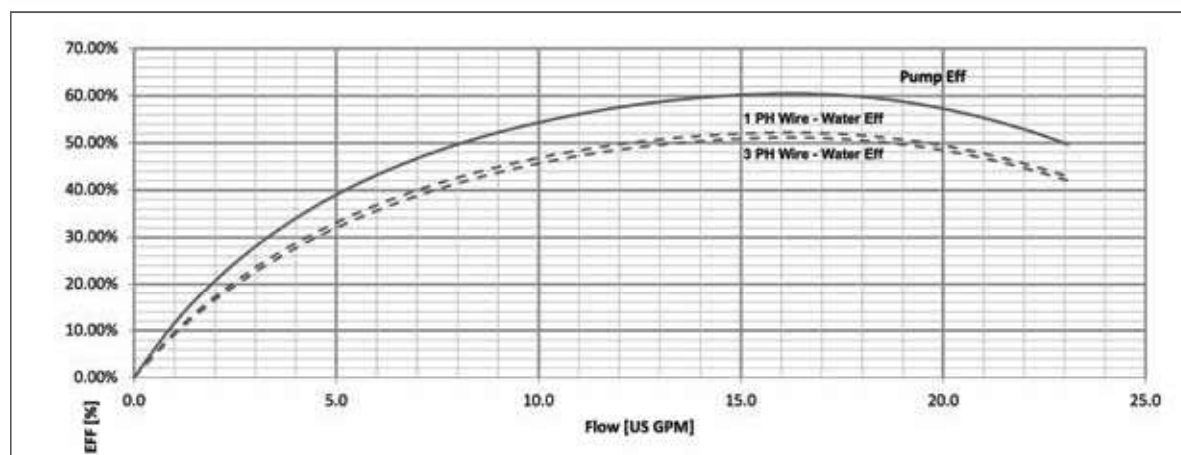
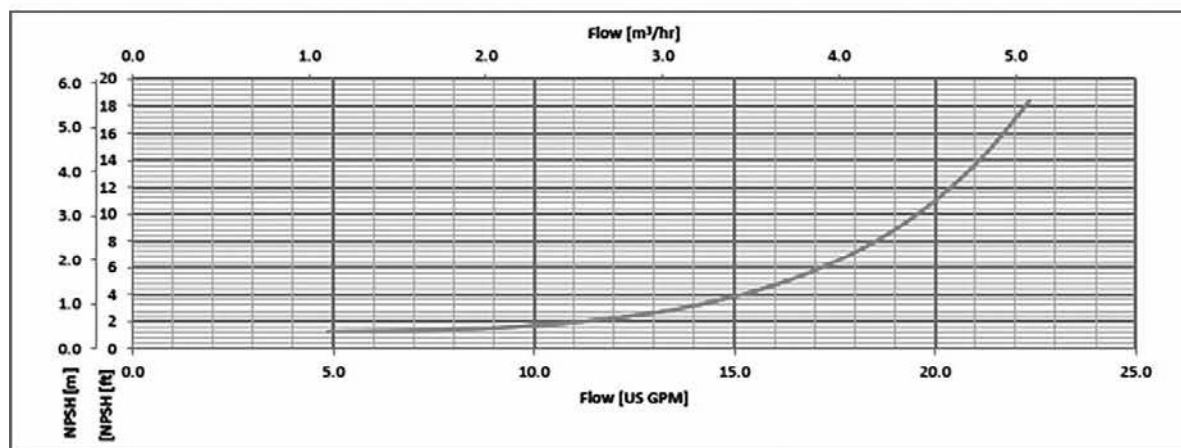
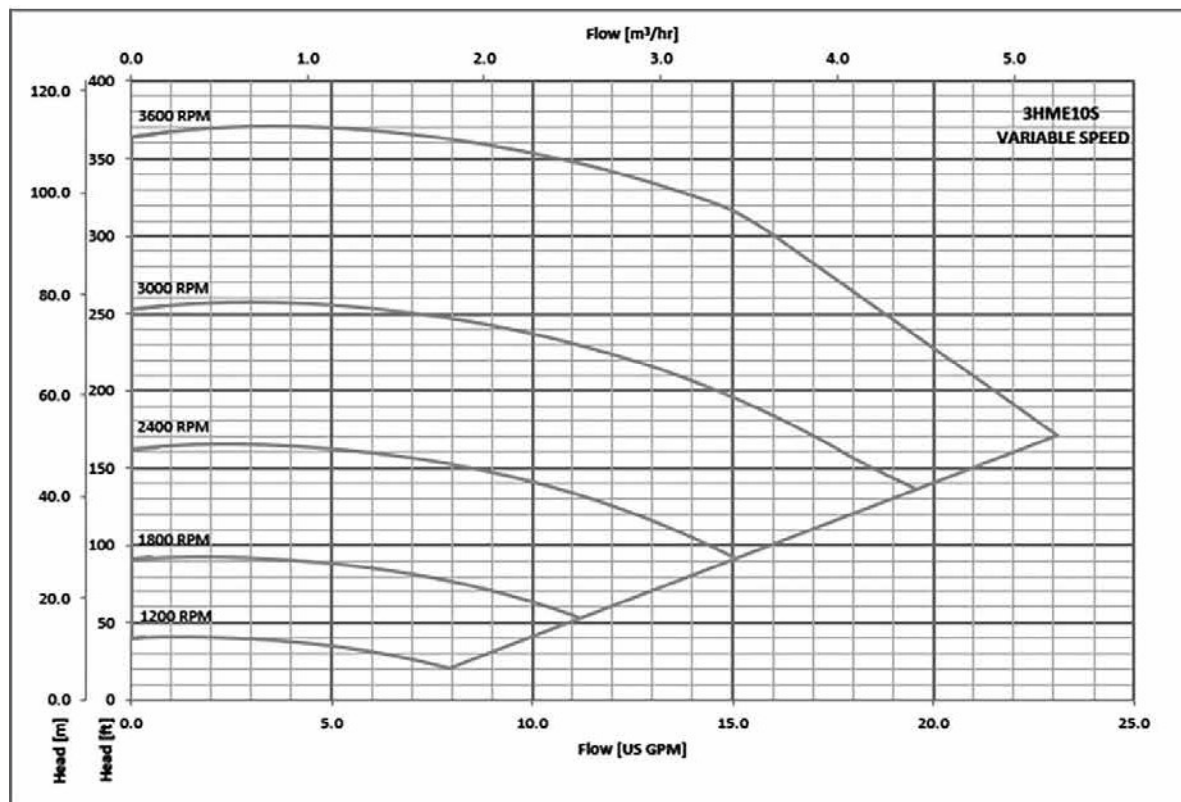

The performances are valid for liquid with density  $\rho = 1 \text{ Kg/dm}^3$  and kinematic viscosity  $\nu = 1 \text{ mm}^2/\text{sec}$ .

### 3HME..N SERIES OPERATING CHARACTERISTICS

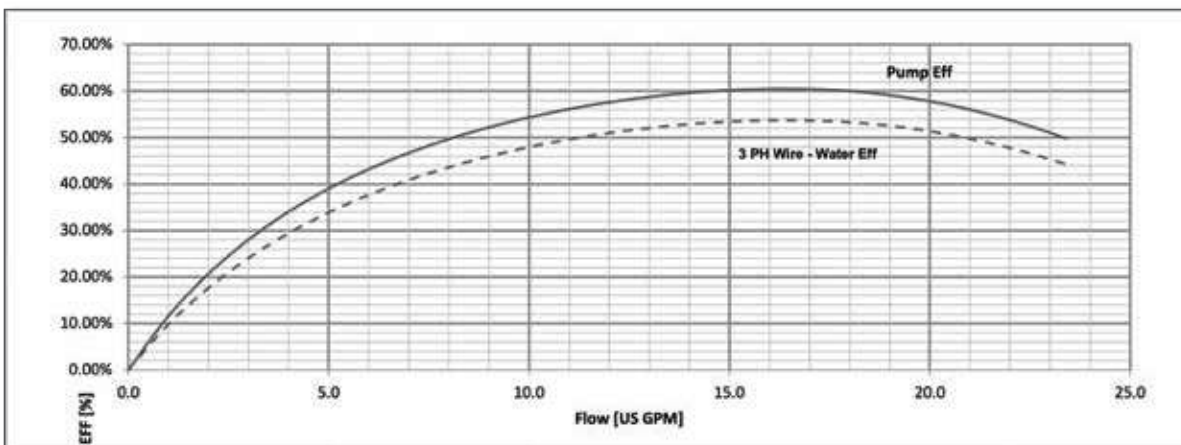
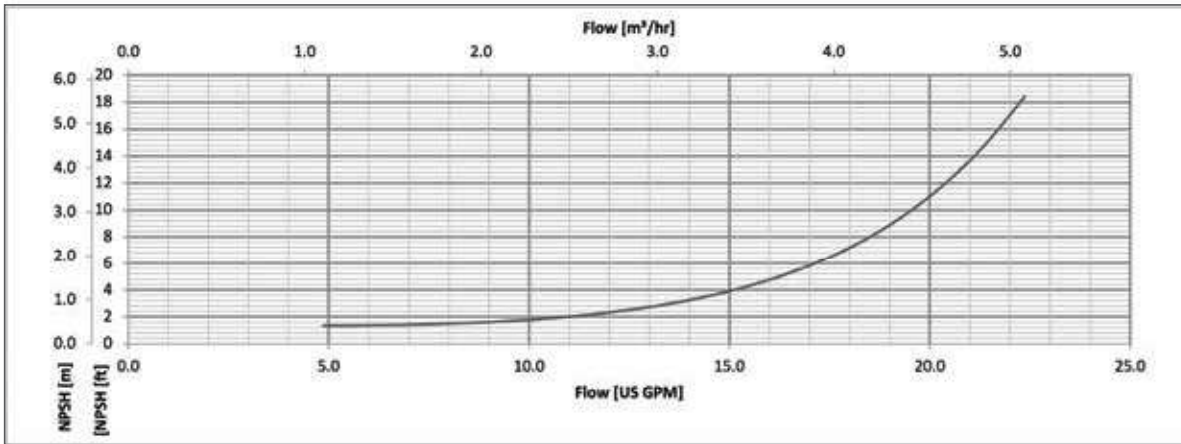
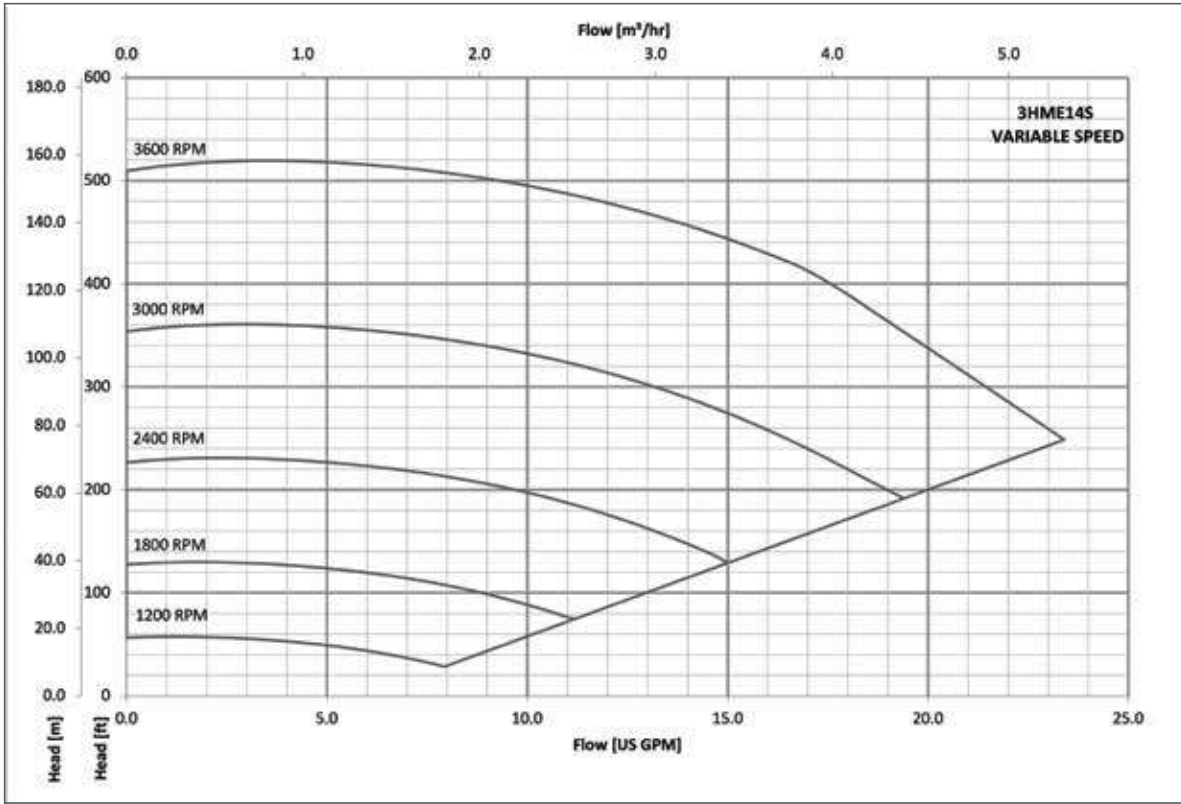

The performances are valid for liquid with density  $\rho = 1 \text{ Kg/dm}^3$  and kinematic viscosity  $\nu = 1 \text{ mm}^2/\text{sec}$ .

## Commercial Water

### 5HME..N SERIES OPERATING CHARACTERISTICS

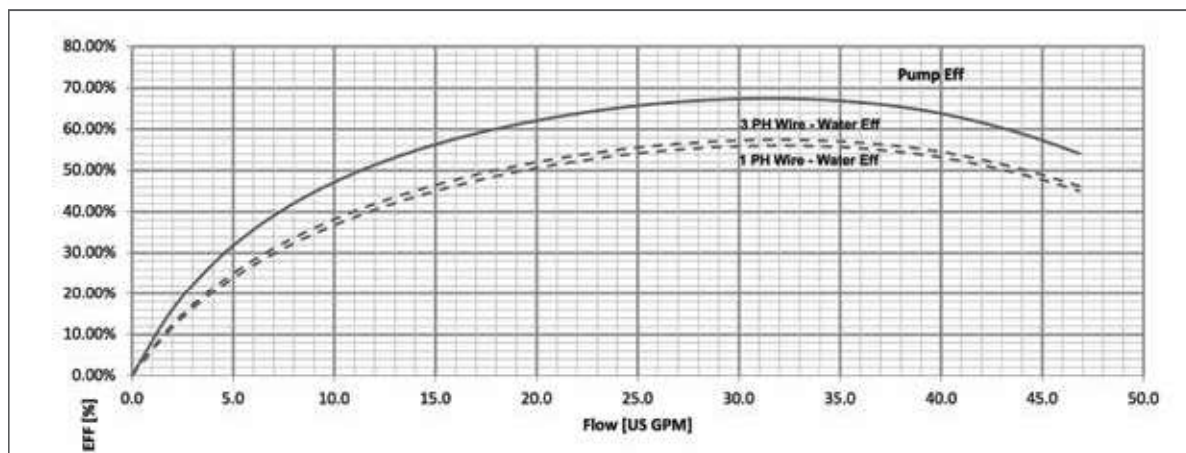
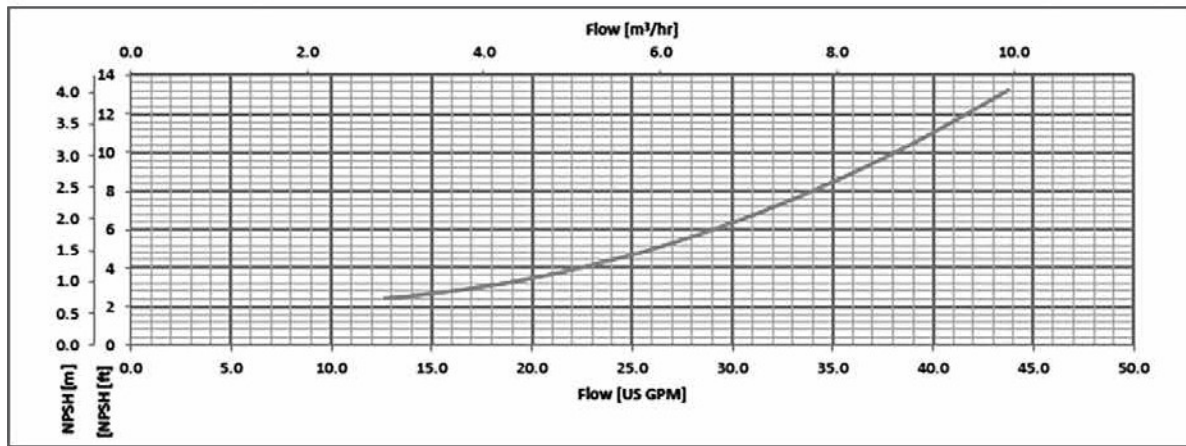
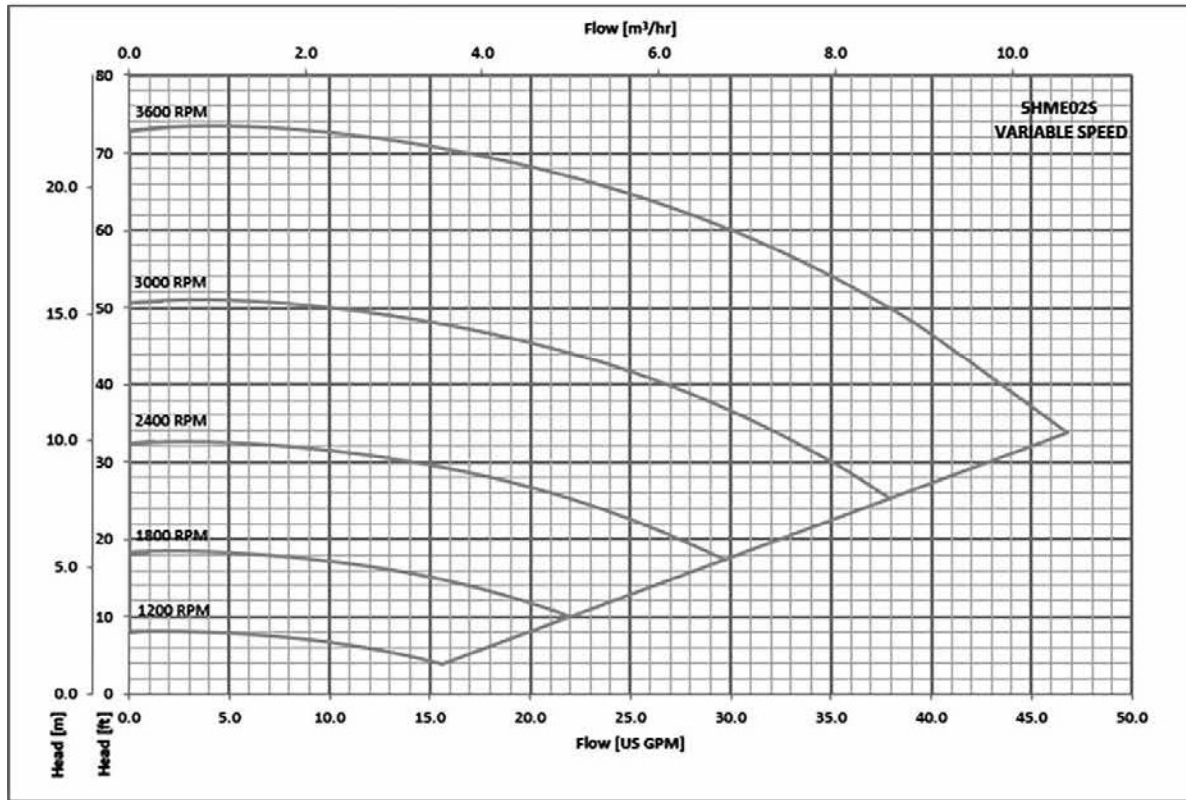

The performances are valid for liquid with density  $\rho = 1 \text{ Kg/dm}^3$  and kinematic viscosity  $\nu = 1 \text{ mm}^2/\text{sec}$ .

### 5HME..N SERIES OPERATING CHARACTERISTICS

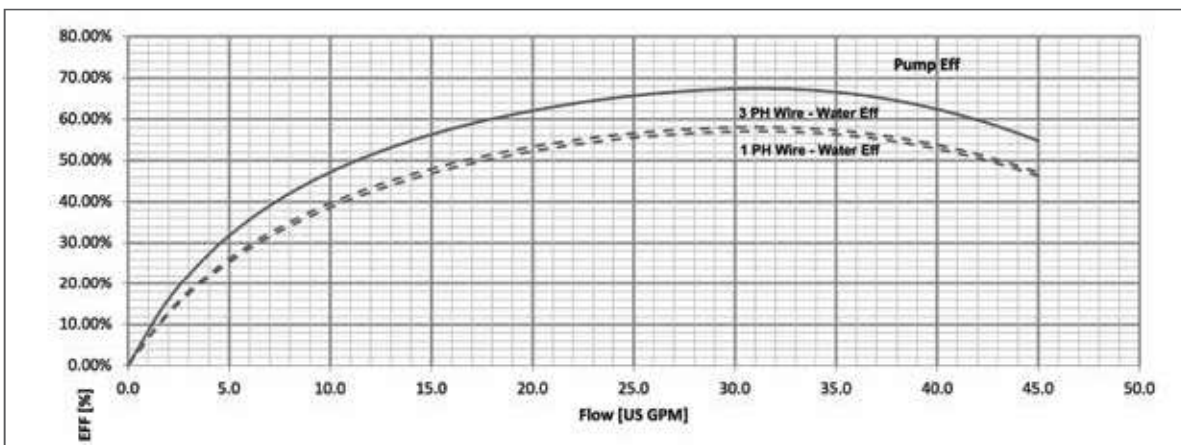
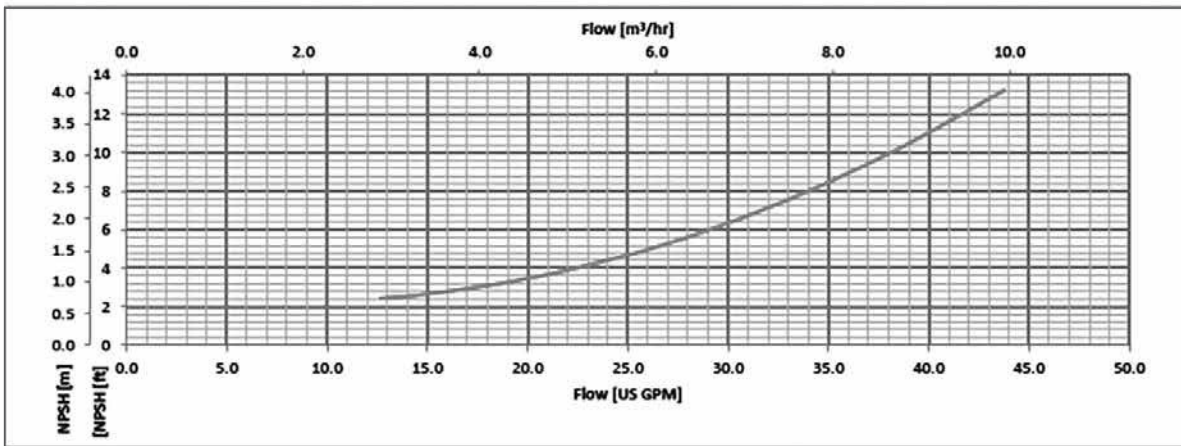
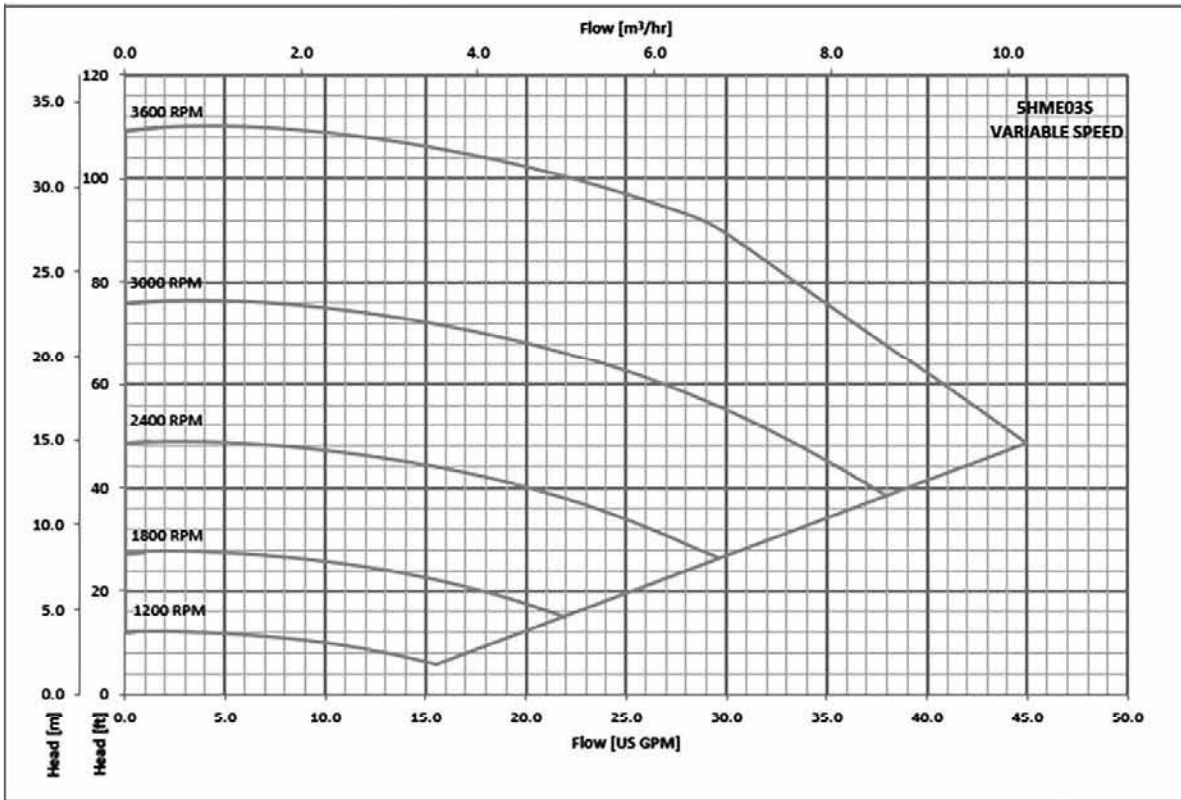

The performances are valid for liquid with density  $\rho = 1 \text{ Kg/dm}^3$  and kinematic viscosity  $\nu = 1 \text{ mm}^2/\text{sec}$ .



## Commercial Water

### 5HME..N SERIES OPERATING CHARACTERISTICS

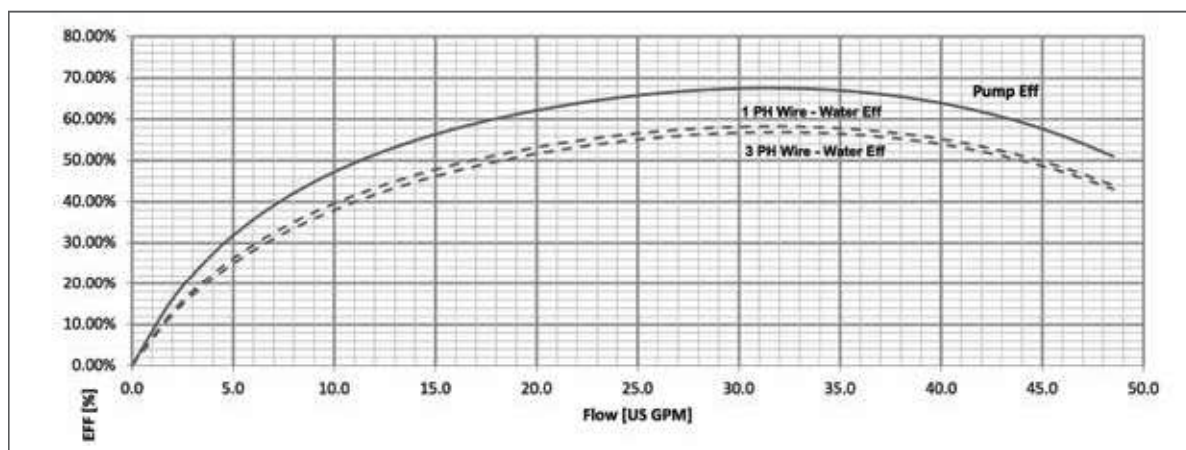
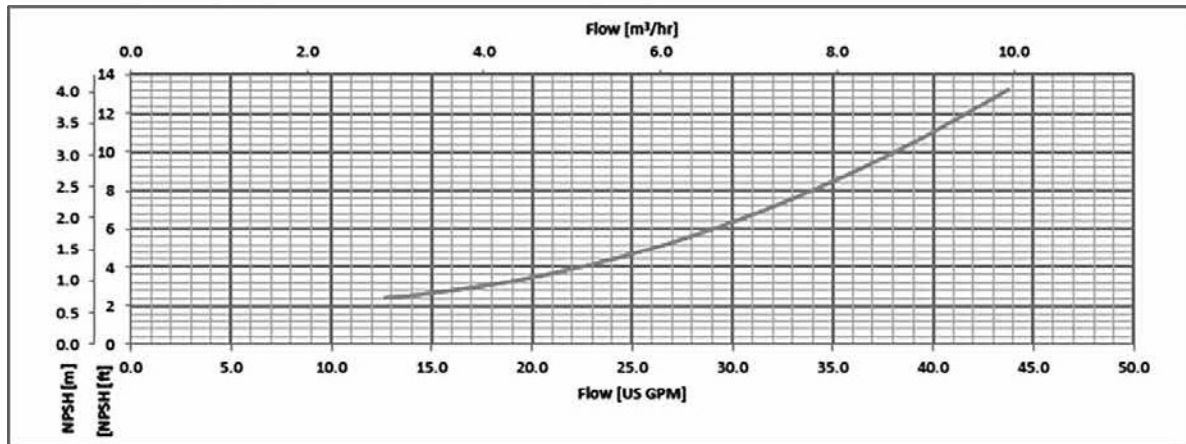
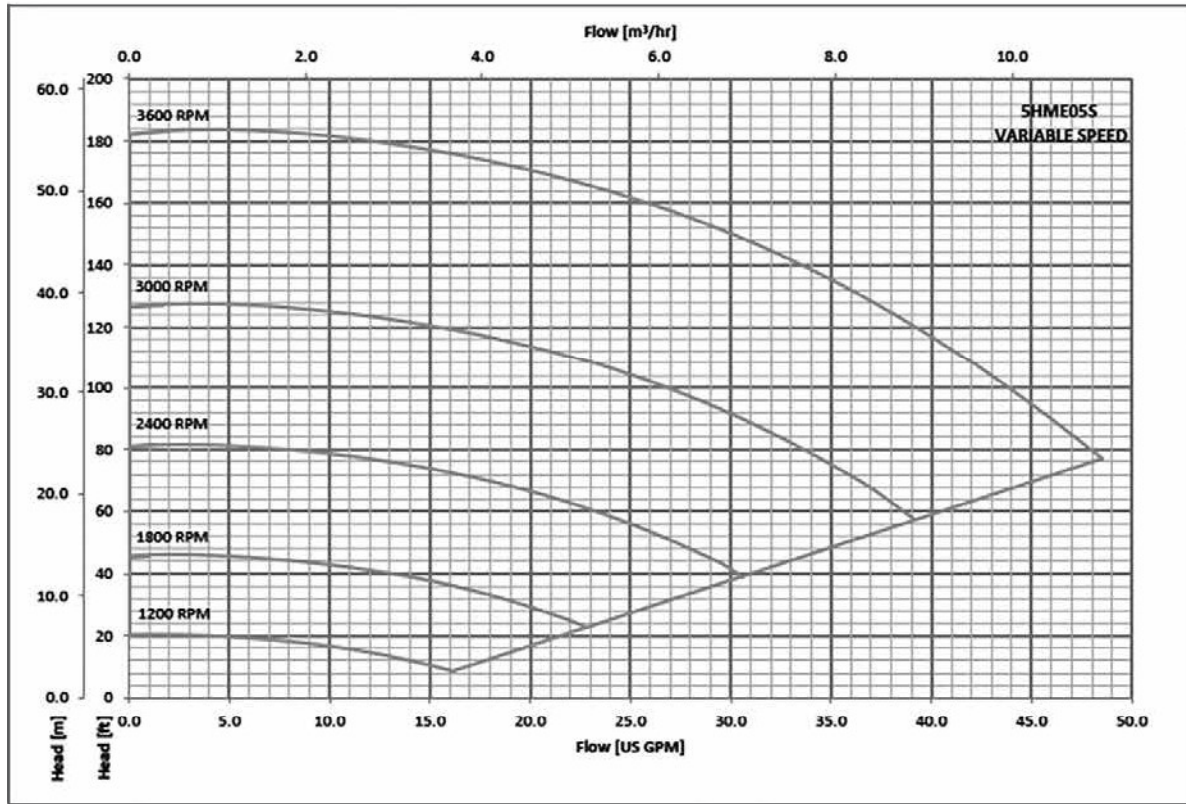

The performances are valid for liquid with density  $\rho = 1 \text{ Kg/dm}^3$  and kinematic viscosity  $\nu = 1 \text{ mm}^2/\text{sec}$ .

### 5HME..N SERIES OPERATING CHARACTERISTICS

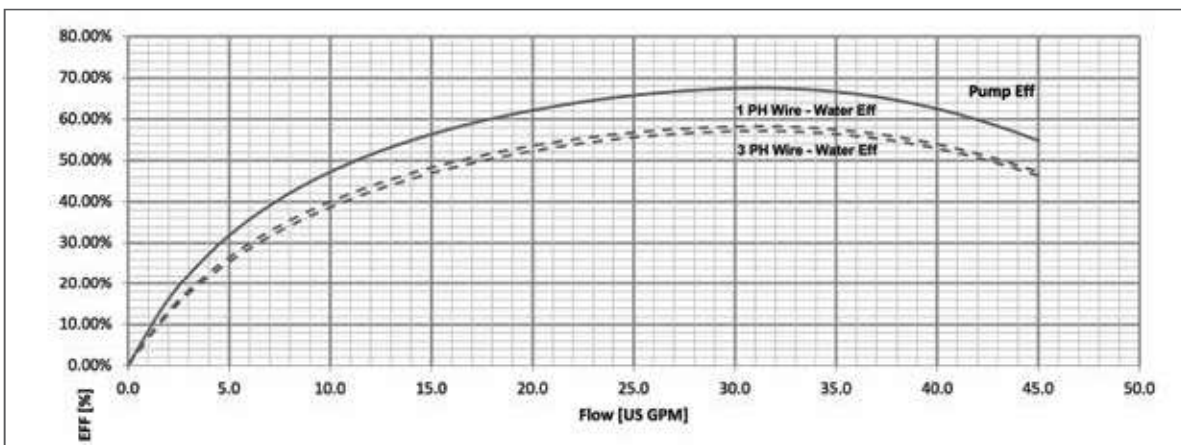
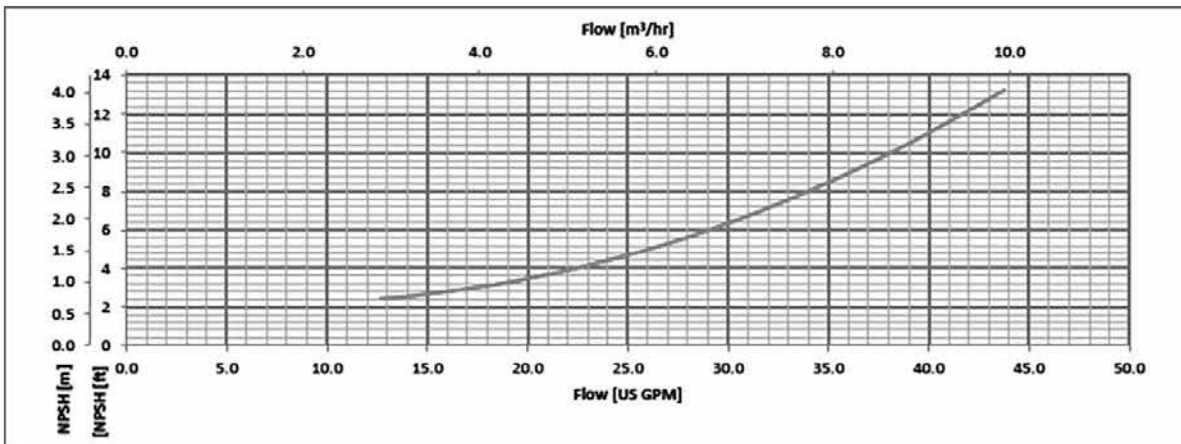
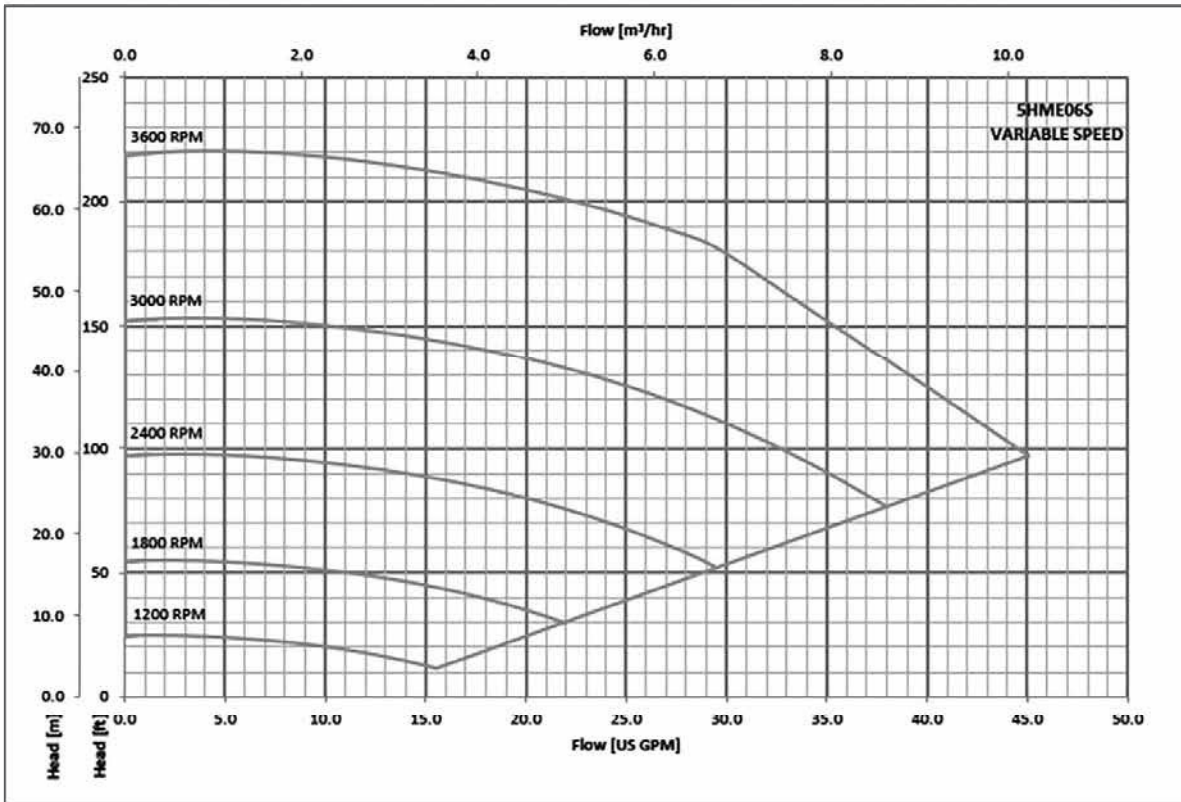

The performances are valid for liquid with density  $\rho = 1 \text{ Kg/dm}^3$  and kinematic viscosity  $\nu = 1 \text{ mm}^2/\text{sec}$ .

## Commercial Water

### 5HME..N SERIES OPERATING CHARACTERISTICS

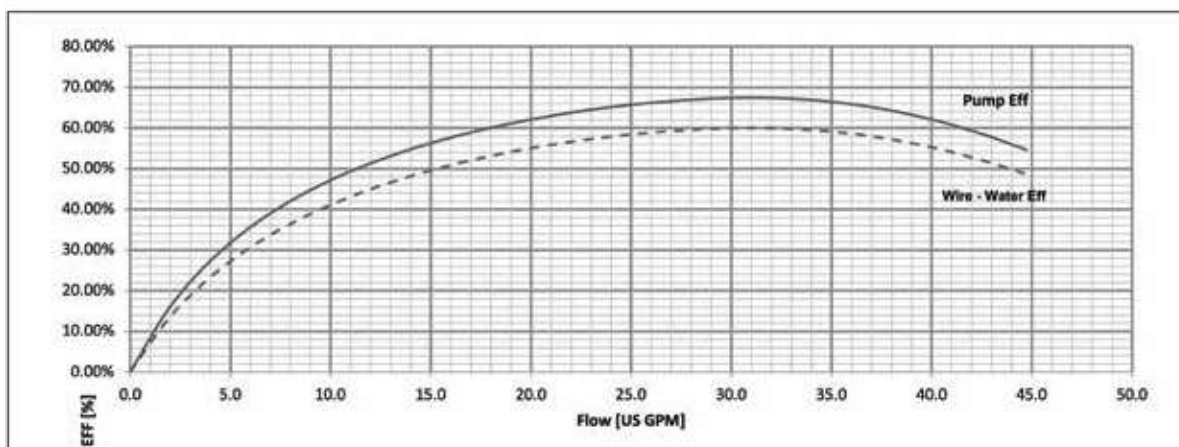
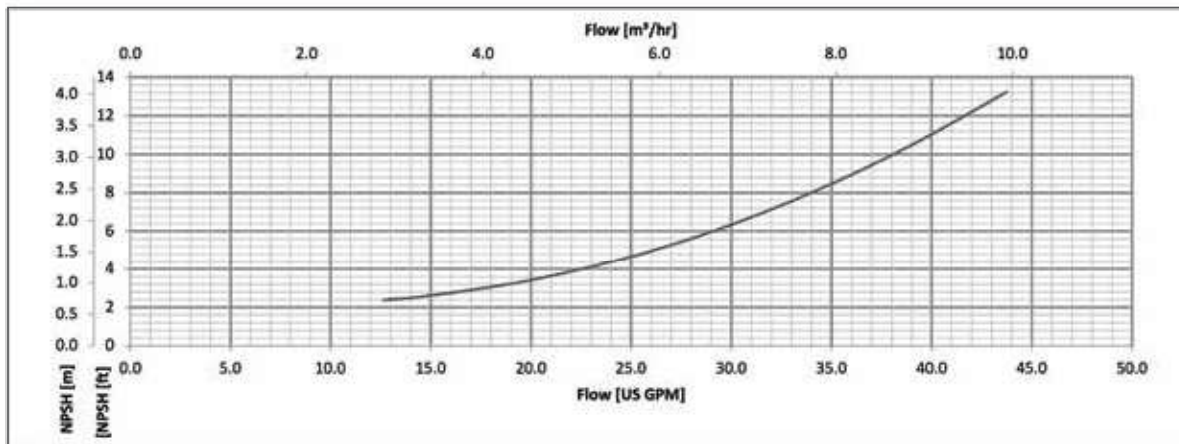
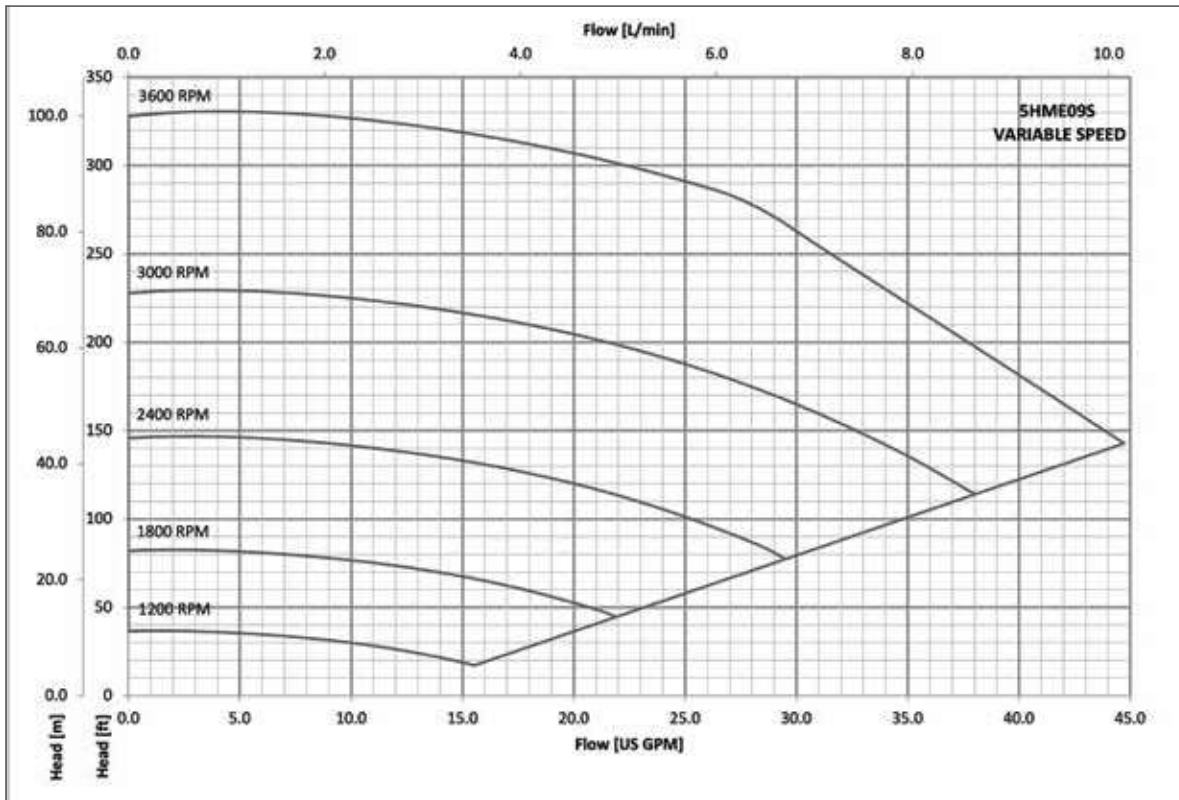

The performances are valid for liquid with density  $\rho = 1 \text{ Kg/dm}^3$  and kinematic viscosity  $\nu = 1 \text{ mm}^2/\text{sec}$ .

### 10, 15HME..N SERIES - SINGLE-PHASE VERSION DIMENSIONS AND WEIGHTS

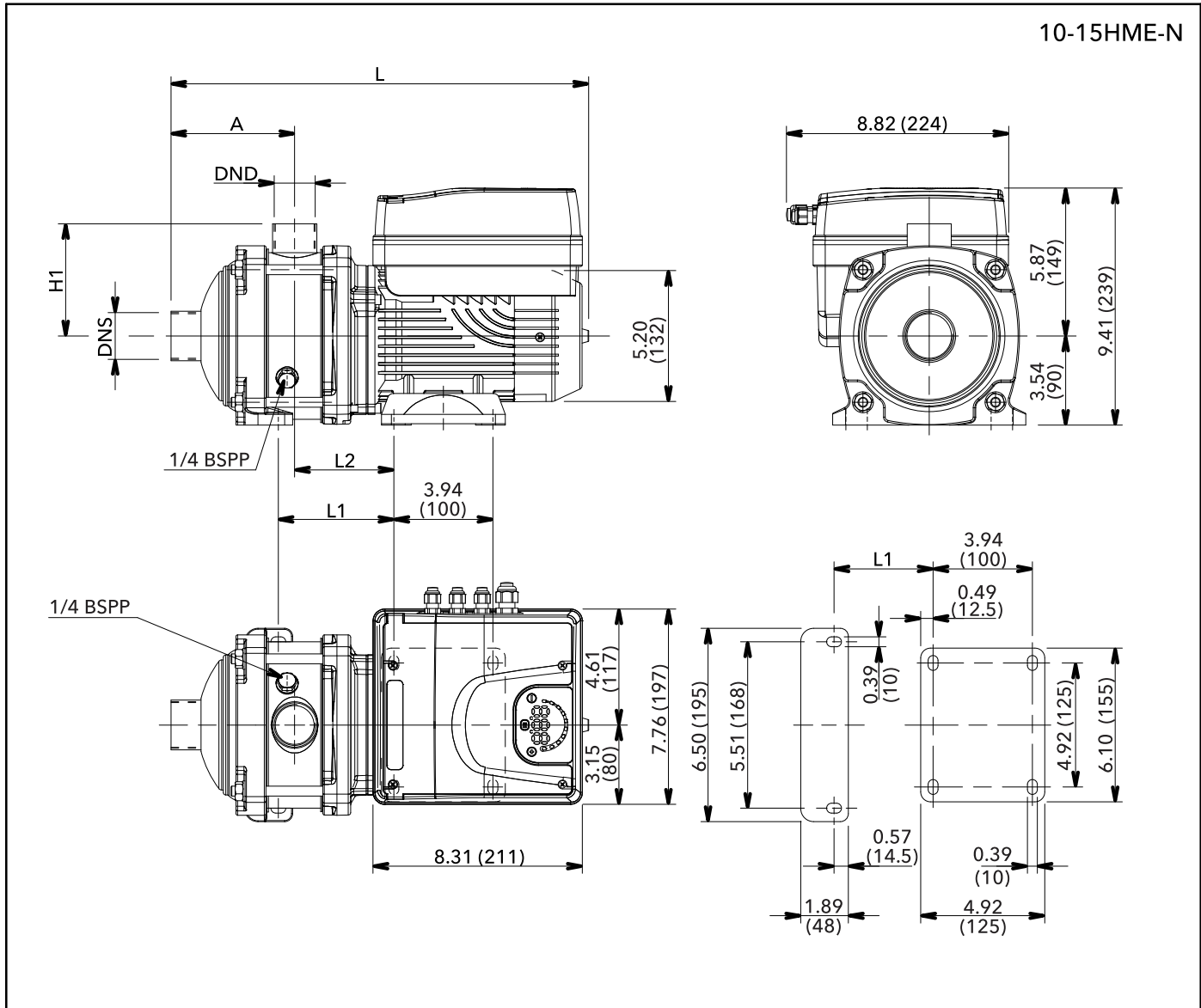

Pump Size Stages	Phase	Motor		Dimensions (in)							Maximum Working Pressure (PSI)	Weight (lbs)
		HP	IEC Frame Size	A	DND	DNS	H1	L	L1	L2		
10HME01N07MM1	SINGLE-PHASE	1.0	80	4.92	1¼" NPT	1¼" NPT	3.54	16.61	4.59	3.94	232	26
10HME02N15MM1		2.0	80	4.92	1¼" NPT	1½" NPT	3.54	16.61	4.59	3.94	232	31
15HME01N15MM1		2.0	80	5.67	1½" NPT	2" NPT	3.54	17.99	5.85	4.57	232	31

## Commercial Water

### 10, 15HME..N SERIES - THREE-PHASE VERSION DIMENSIONS AND WEIGHTS

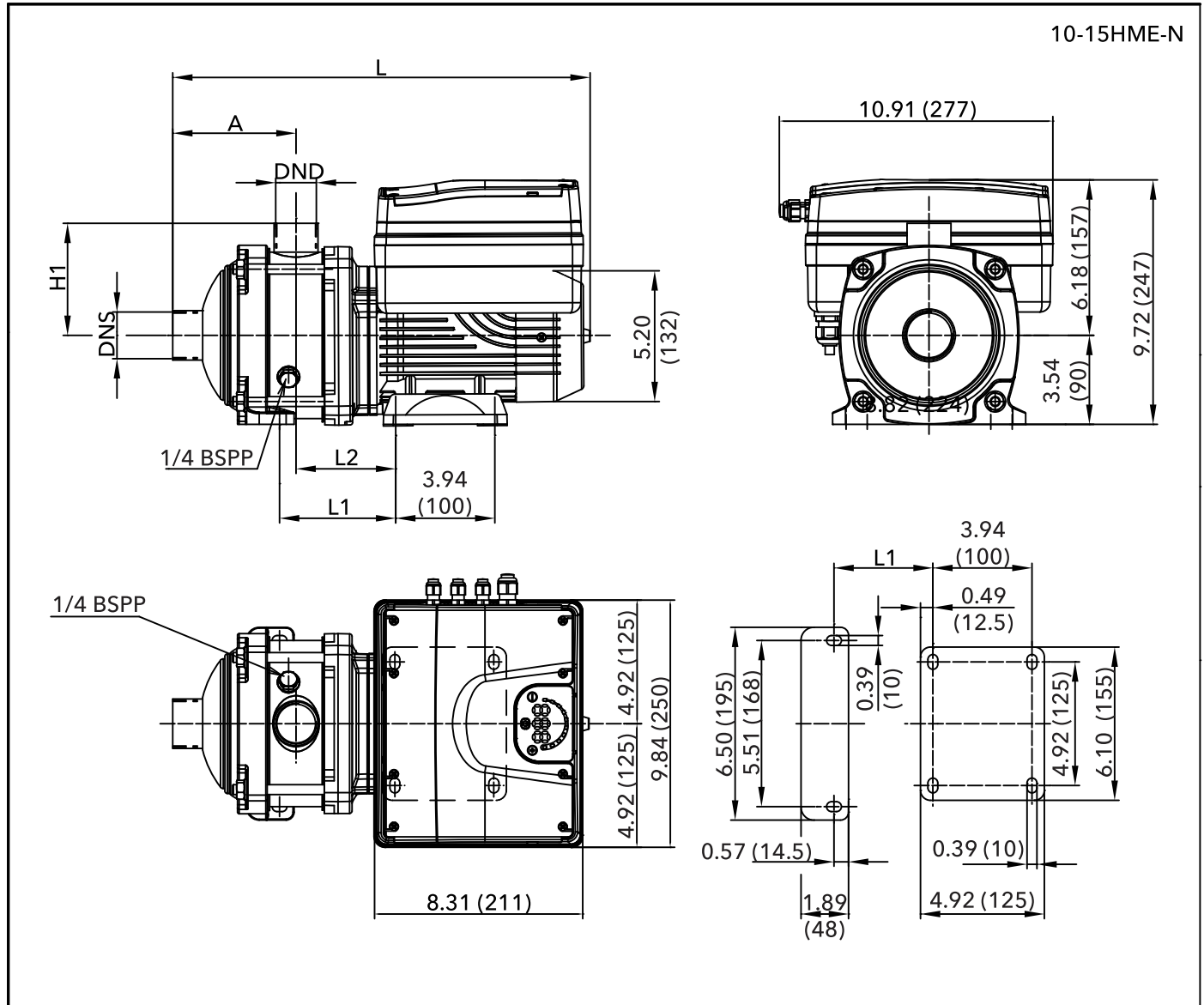

Pump Size Stages	Phase	Motor		Dimensions (in)							Maximum Working Pressure (PSI)	Weight (lbs)
		HP	IEC Frame Size	A	DND	DNS	H1	L	L1	L2		
10HME01N07TM2	THREE-PHASE	1.0	80	4.92	1¼" NPT	1¼" NPT	3.54	16.61	4.59	3.94	232	40
10HME02N15TM2		2.0	80	4.92	1¼" NPT	1½" NPT	3.54	16.61	4.59	3.94	232	42
10HME03N22TM4		3.0	80	4.92	1¼" NPT	1½" NPT	3.54	16.61	4.59	3.94	232	42
15HME01N15TM2		2.0	80	5.67	1½" NPT	2" NPT	3.54	17.99	5.85	4.57	232	44
15HME02N22TM4		3.0	80	5.67	1½" NPT	2" NPT	3.54	17.99	5.85	4.57	232	44

### 10HME..N SERIES OPERATING CHARACTERISTICS

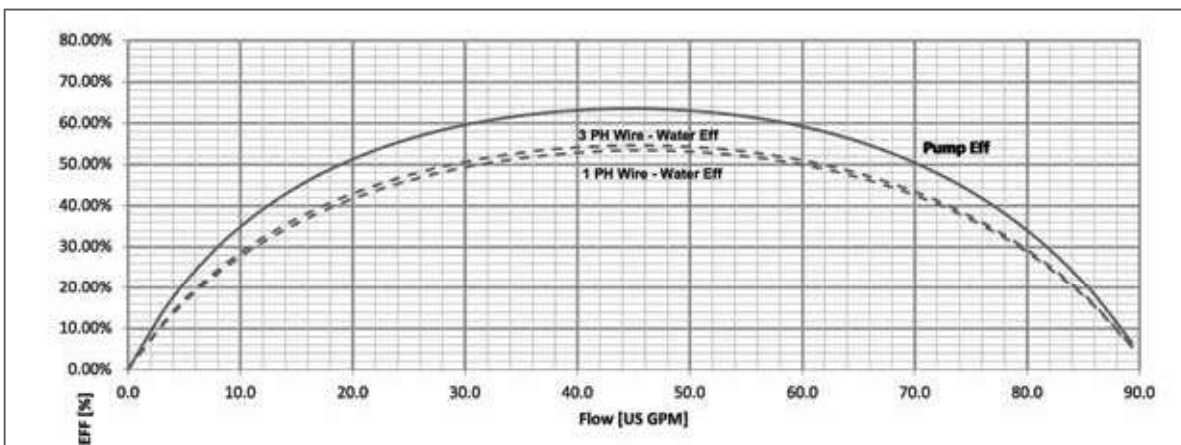
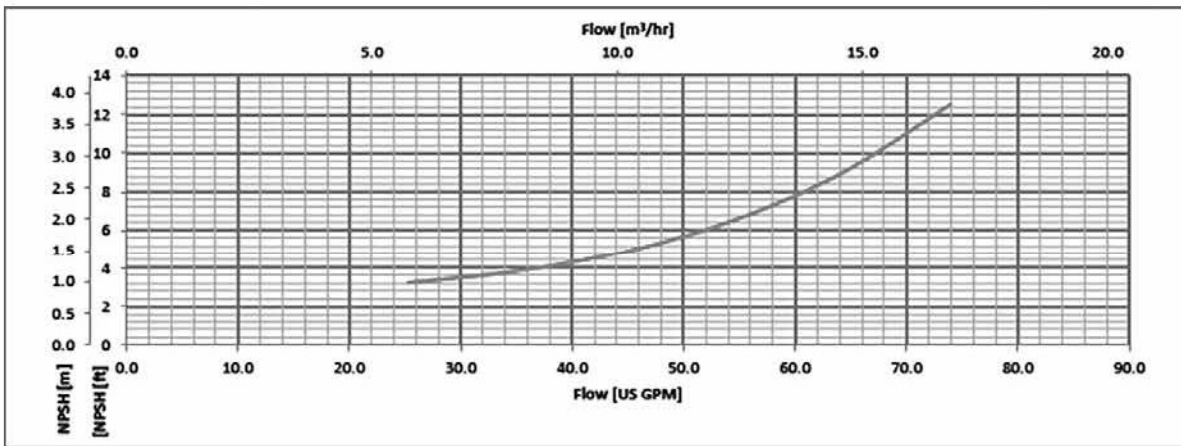
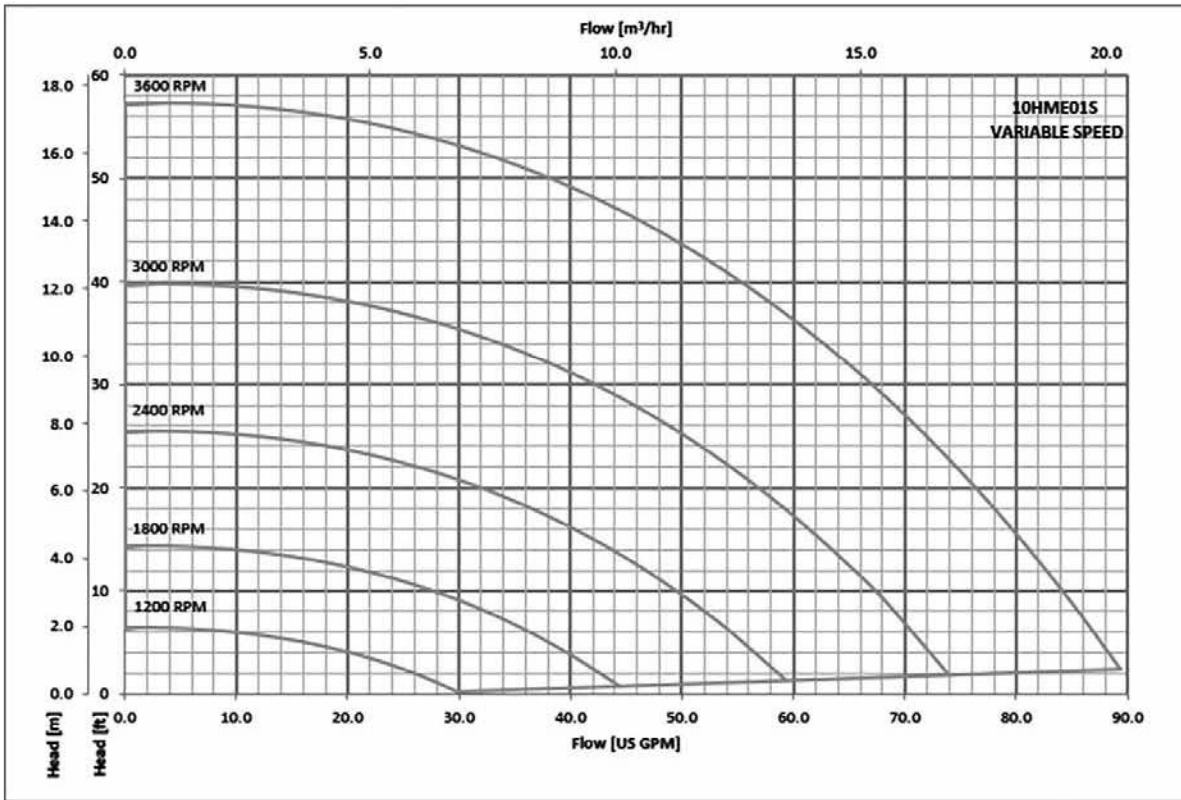

The performances are valid for liquid with density  $\rho = 1 \text{ Kg/dm}^3$  and kinematic viscosity  $\nu = 1 \text{ mm}^2/\text{sec}$ .

## Commercial Water

### 10HME..N SERIES OPERATING CHARACTERISTICS

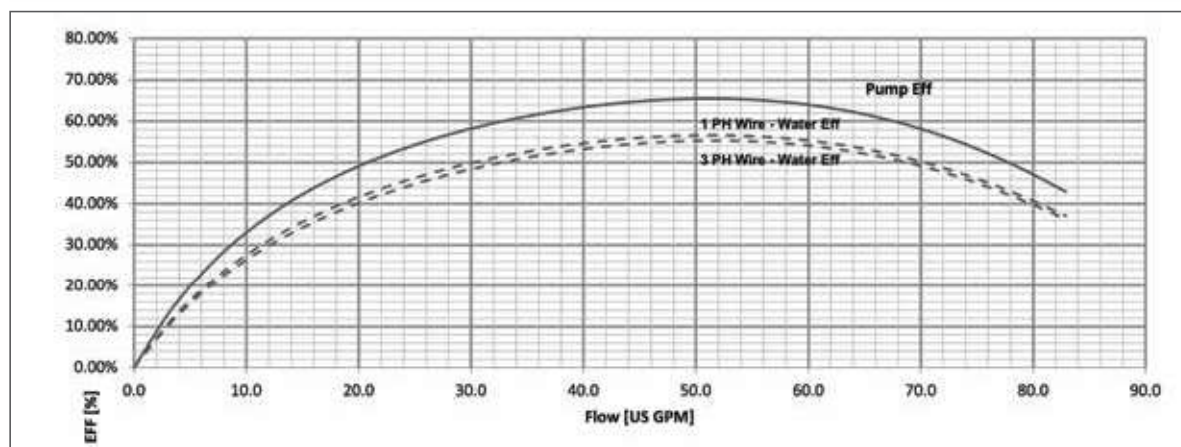
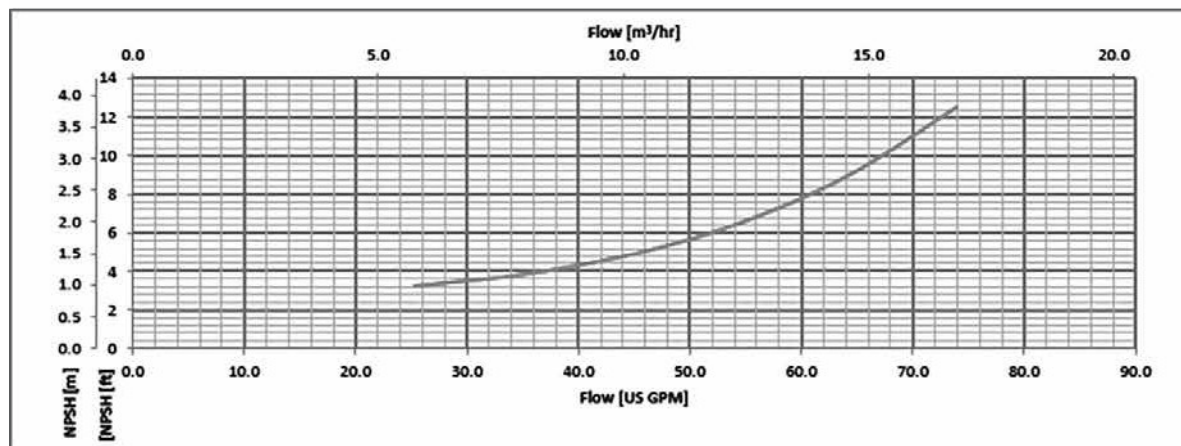
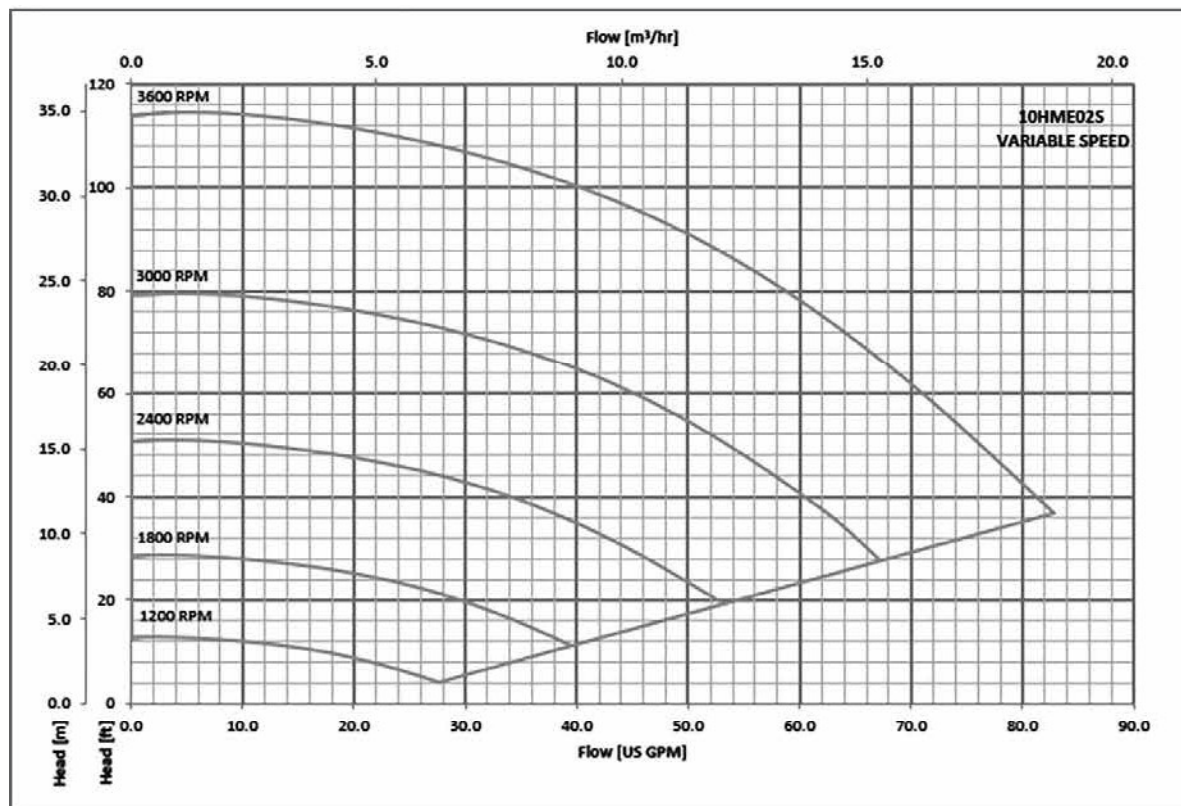

The performances are valid for liquid with density  $\rho = 1 \text{ Kg/dm}^3$  and kinematic viscosity  $\nu = 1 \text{ mm}^2/\text{sec}$ .

### 10HME..N SERIES OPERATING CHARACTERISTICS

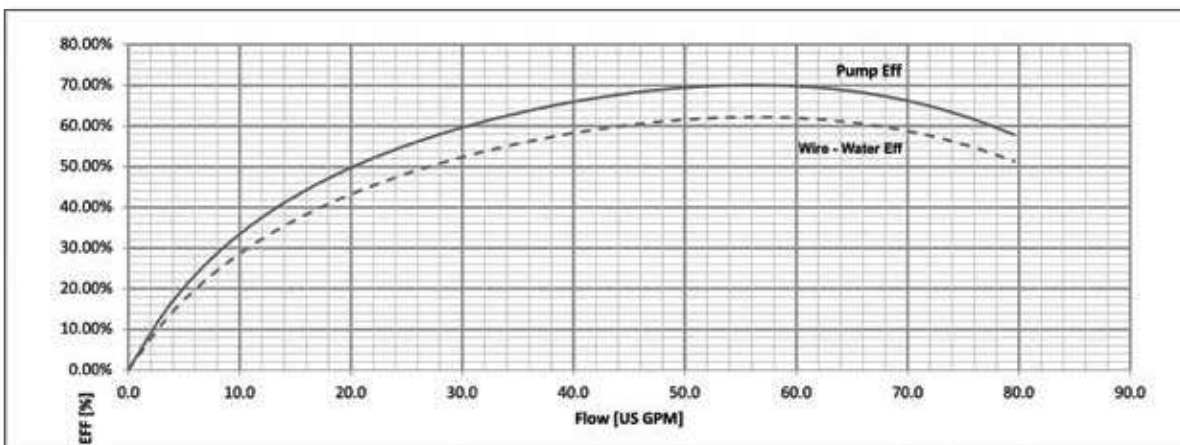
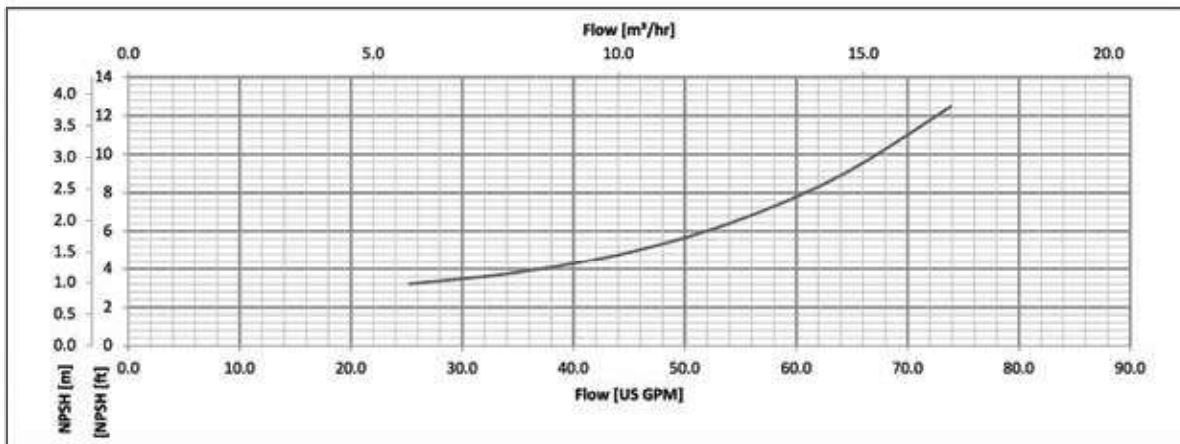
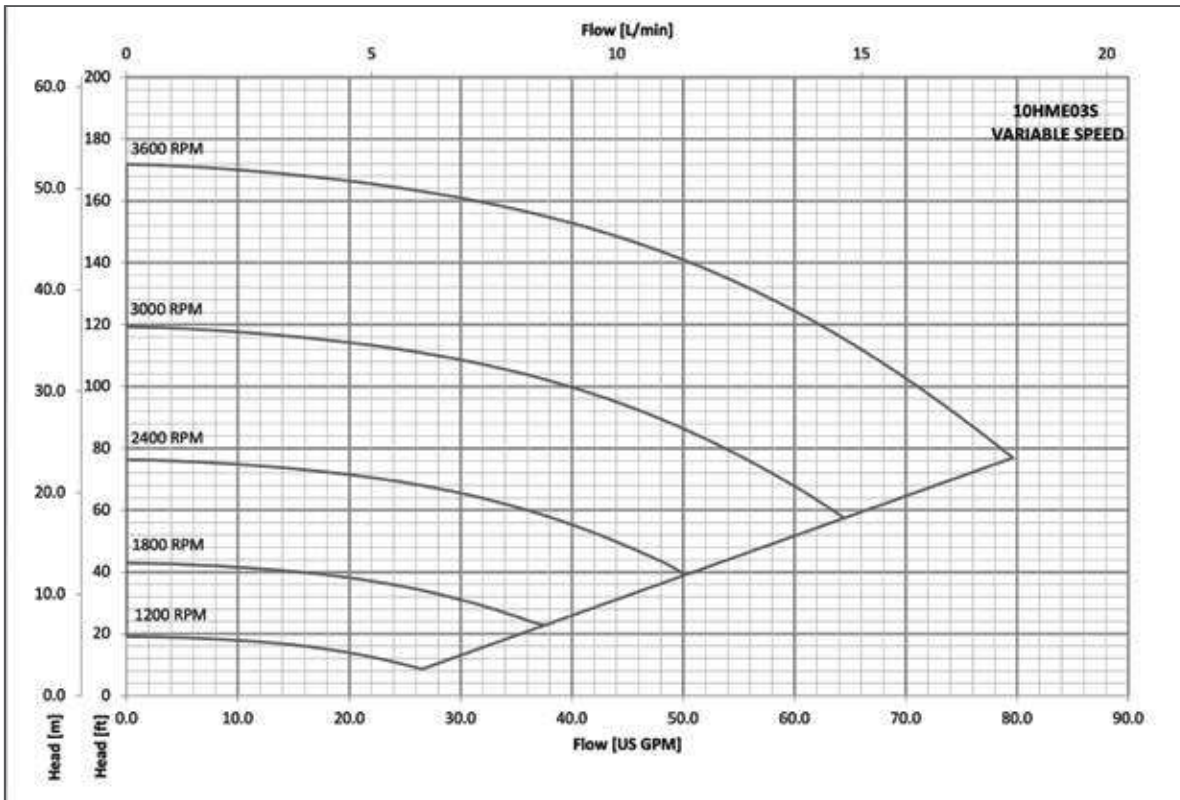

The performances are valid for liquid with density  $\rho = 1 \text{ Kg/dm}^3$  and kinematic viscosity  $\nu = 1 \text{ mm}^2/\text{sec}$ .



## Commercial Water

### 15HME..N SERIES OPERATING CHARACTERISTICS

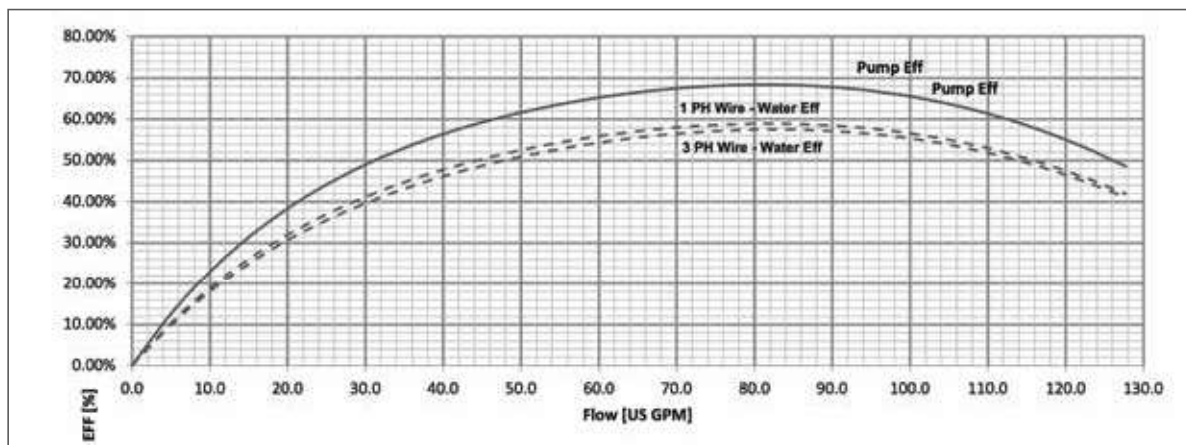
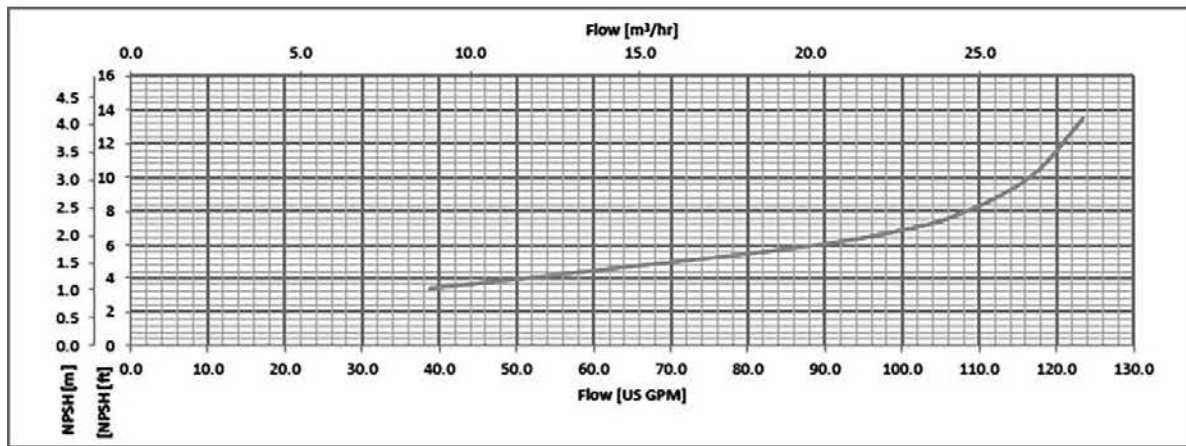
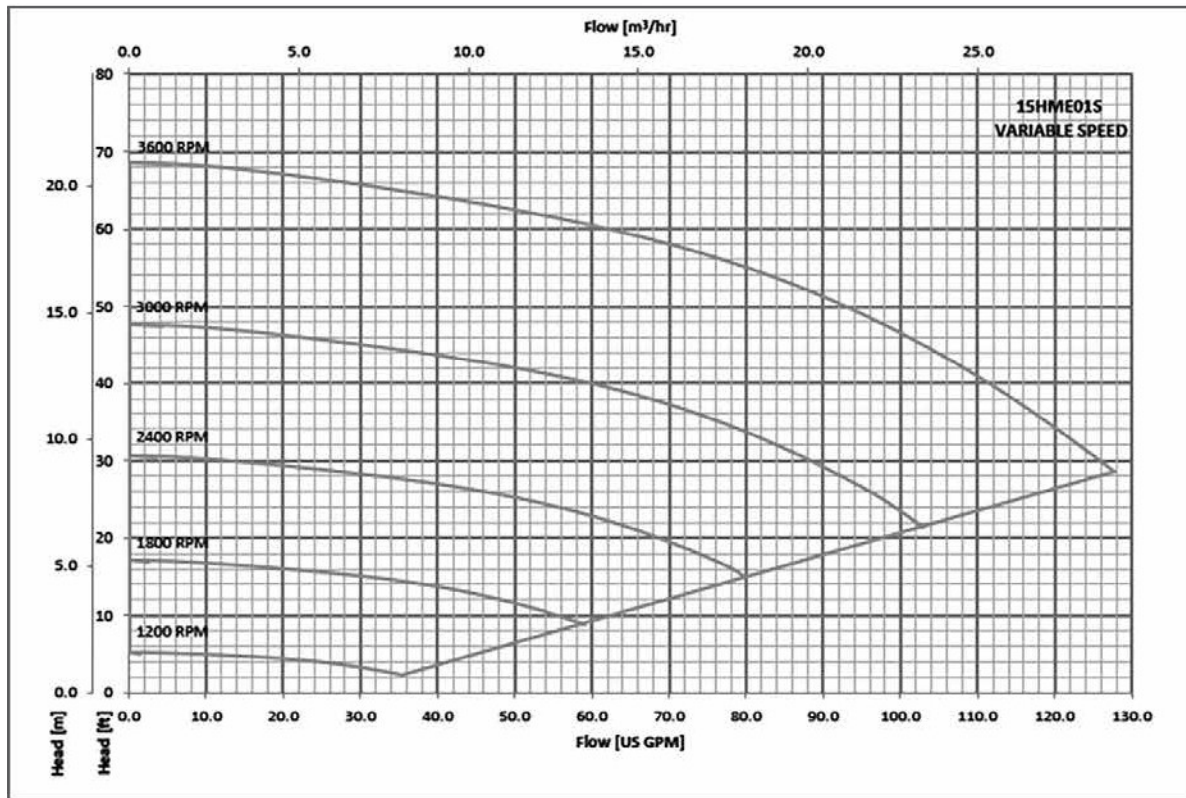

The performances are valid for liquid with density  $\rho = 1 \text{ Kg/dm}^3$  and kinematic viscosity  $\nu = 1 \text{ mm}^2/\text{sec}$ .

### 15HME..N SERIES OPERATING CHARACTERISTICS

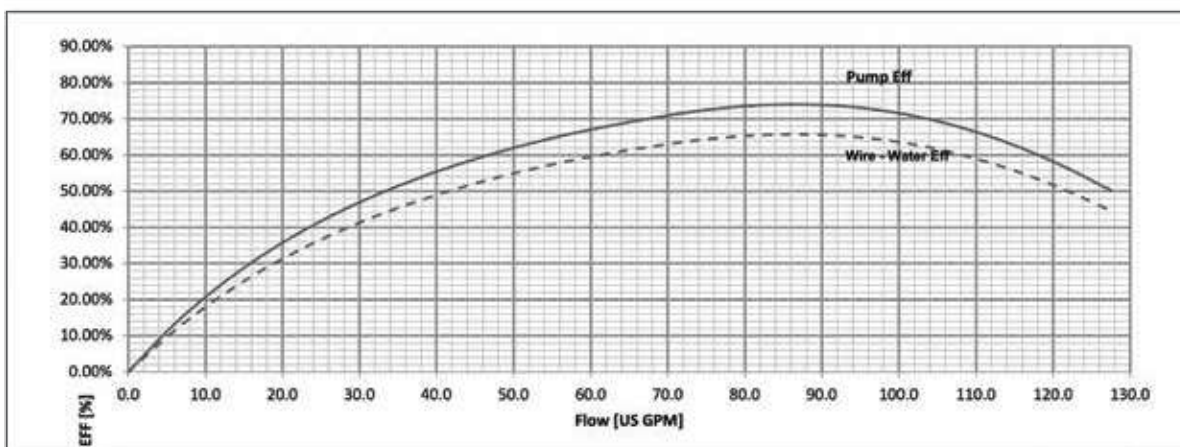
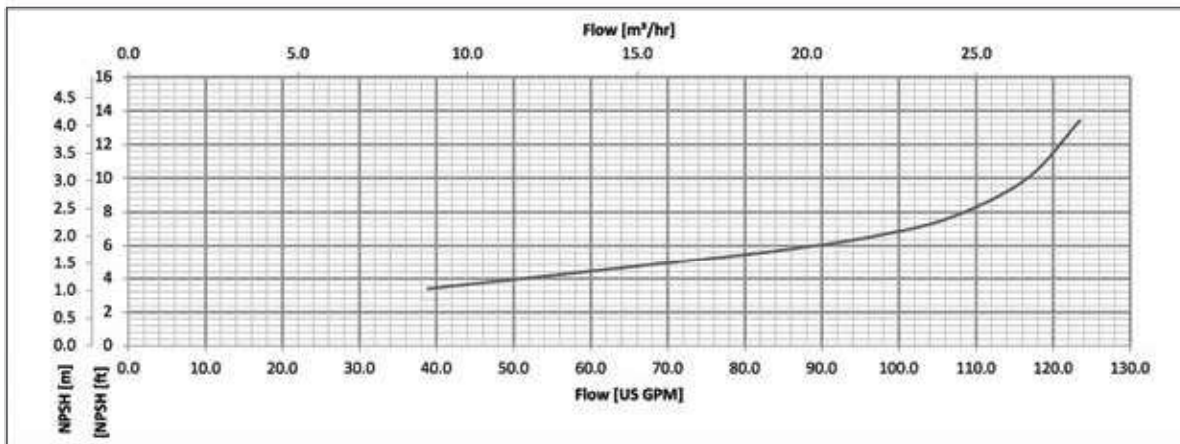
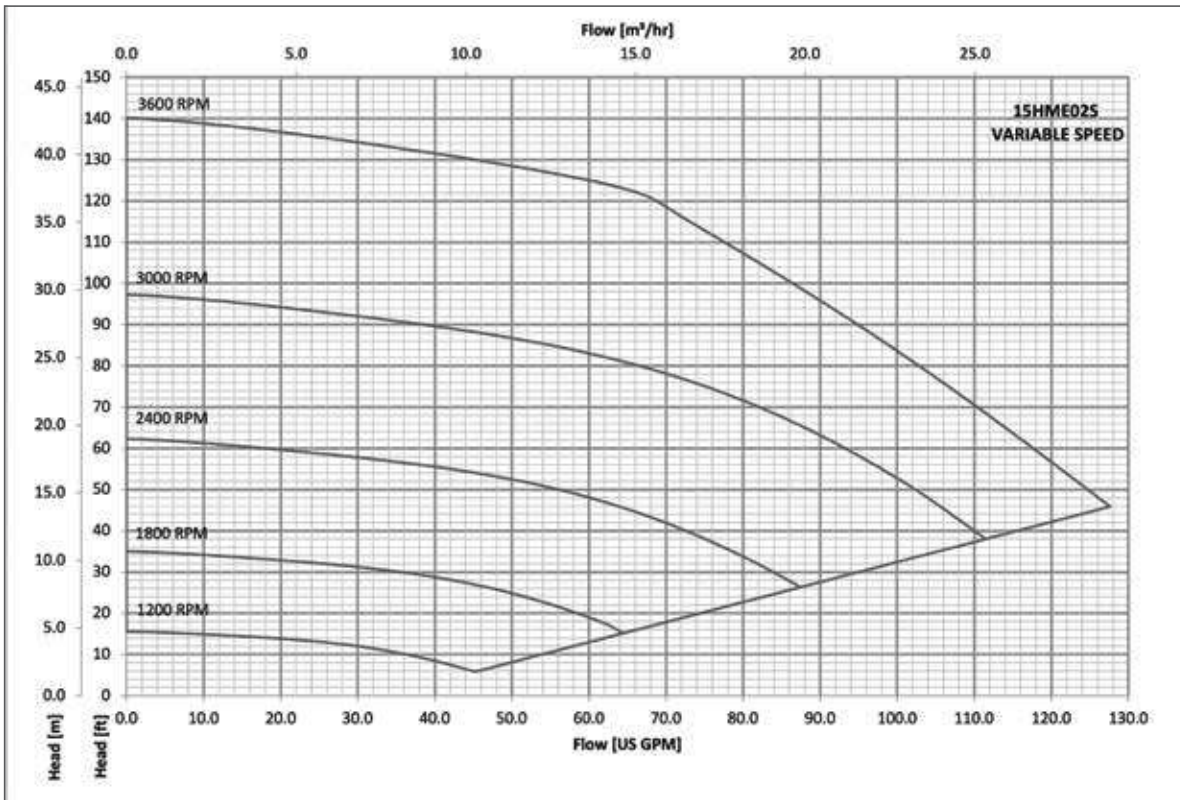

The performances are valid for liquid with density  $\rho = 1 \text{ Kg/dm}^3$  and kinematic viscosity  $\nu = 1 \text{ mm}^2/\text{sec}$ .

### TECHNICAL DATA - WATER PROPERTY CHART

Temp °F	Temp °C	Specific Volume (Cubic ft/lb)	Specific Gravity			Weight (lb/cubic ft)	Vapor Pressure (psi Abs)
			@ 39.2°F	@ 60°F	@ 68°F		
32	0.0	0.01602	1.000	1.001	1.002	62.42	0.088
35	1.7	0.01602	1.000	1.001	1.002	62.42	0.100
40	4.4	0.01602	1.000	1.001	1.002	62.42	0.122
50	10.0	0.01603	0.999	1.001	1.002	62.38	0.178
60	15.6	0.01604	0.999	1.000	1.001	62.34	0.256
70	21.1	0.01606	0.998	0.999	1.000	62.27	0.363
80	26.7	0.01608	0.996	0.998	0.999	62.19	0.507
90	32.2	0.0161	0.995	0.996	0.997	62.11	0.698
100	37.8	0.01613	0.993	0.994	0.995	62.00	0.949
120	48.9	0.0162	0.989	0.990	0.991	61.73	1.692
140	60.0	0.01629	0.983	0.985	0.986	61.39	2.889
160	71.1	0.01639	0.977	0.979	0.979	61.01	4.741
180	82.2	0.01651	0.970	0.972	0.973	60.57	7.510
200	93.3	0.01663	0.963	0.964	0.966	60.13	11.526
212	100.0	0.01672	0.958	0.959	0.960	59.81	14.696
220	104.4	0.01677	0.955	0.956	0.957	59.63	17.186
240	115.6	0.01692	0.947	0.948	0.949	59.10	24.97
260	126.7	0.01709	0.938	0.939	0.940	58.51	35.43
280	137.8	0.01726	0.928	0.929	0.930	58.00	49.20
300	148.9	0.01745	0.918	0.919	0.920	57.31	67.01
320	160.0	0.01756	0.908	0.909	0.910	56.66	89.66
340	171.1	0.01787	0.896	0.898	0.899	55.96	118.01
360	182.2	0.01811	0.885	0.886	0.887	55.22	153.04
380	193.3	0.01836	0.873	0.874	0.875	54.47	195.77
400	204.4	0.01864	0.859	0.860	0.862	53.65	247.31
420	215.6	0.01894	0.846	0.847	0.848	52.80	308.83
440	226.7	0.01926	0.832	0.833	0.834	51.92	381.59
460	237.8	0.0196	0.817	0.818	0.819	51.02	466.9
480	248.9	0.02	0.801	0.802	0.803	50.00	566.1
500	260.0	0.0204	0.785	0.786	0.787	49.02	680.8
520	271.1	0.0209	0.765	0.766	0.767	47.85	812.4
540	282.2	0.0215	0.746	0.747	0.748	46.51	962.5
560	293.3	0.0221	0.726	0.727	0.728	45.30	1133.1
580	304.4	0.0228	0.703	0.704	0.704	43.90	1325.8
600	315.6	0.0236	0.678	0.679	0.680	42.30	1542.9
620	326.7	0.0247	0.649	0.650	0.650	40.50	1786.6
640	337.8	0.026	0.617	0.618	0.618	38.50	2059.7
660	348.9	0.0278	0.577	0.577	0.578	36.00	2365.4
680	360.0	0.0305	0.525	0.526	0.527	32.80	2708.1
700	371.1	0.0369	0.434	0.435	0.435	27.10	3093.7

### TECHNICAL DATA - COMPATABILITY CHART FOR MATERIALS IN CONTACT WITH MOST COMMONLY USED LIQUIDS

Liquid	Concentration (%)	Temperature Min/Max °F	Specific Weight (lb/in <sup>3</sup> )	1HM - 22HM	Recommended Seal	Elastomers
				316		
Water	100	23/248		•	QBEGG	E
Deionized, demineralized	100	-13/230		•	QBEGG	E
Water and oil emulsion	any	23/194		•	QBVGG	V
Acetic acid (•)	80	14/158	.038	•	QBEGG	E
Citric acid	5	14/158	.056	•	QBEGG	E
Hydrochloric acid	2	23/77	.043	•	QQVGG	V
Phosphoric acid	10	23/86	.048	•	QBEGG	E
Nitric acid (•)	50	23/86	.053	•	QQVGG	V
Sulphuric acid (•)	2	14/77	.066	•	QBVGG	V
Tannic acid	20	32/122		•	QBEGG	E
Tartaric acid	50	14/77	.063	•	QQVGG	V
Uric acid	80	14/176	.068	•	QBEGG	E
Benzoic acid	70	32/158	.047	•	QBVGG	V
Boric acid	Saturated	14/194	.052	•	QQVGG	V
Formic acid (•)	5	5/77	.044	•	QBEGG	E
Ethyl alcohol (•)	100	23/104	.029	•	QBEGG	E
Methyl alcohol (•)	100	23/104	.029	•	QBEGG	E
Propyl alcohol (•)	100	23/176	.029	•	QBEGG	E
Butyl alcohol	100	23/176	.030	•	QBVGG	V
Denatured alcohol (•)	100	23/158	.030	•	QBEGG	E
Ammonia in water (•)	25	-4/122	.038	•	QBEGG	E
Chloroform		14/86	.053	•	QBVGG	V
Caustic soda	25	32/158	.077	•	QQEGG	E
Water, detergents, Cleaning products		23/176		•	QQVGG	V
		23/212		•	QQVGG	V
Diesel oil (•)	100	32/176	.033	•	QBVGG	V
Kerosene (•)	100	32/176		•	QBVGG	V
Fuel oil (•)		32/194	.027	•	QBVGG	V
Glycerine	100	68/194	.046	•	QBEGG	E
Sodium Hypochlorite	1	14/77		•	QQVGG	V
Phosphates/polyphosphates		23/194		•	QQVGG	V
Sodium nitrate	Saturated	14/176	.081	•	QBEGG	E
Cutting fluid	100	23/230	.033	•	QBVGG	V
Peanut oil (•)	100	23/230	.034	•	QBEGG	E
Colza oil (•)	100	23/230	.034	•	QBEGG	E
Linseed oil (•)	100	23/230	.034	•	QBEGG	E
Coconut oil (•)	100	-4/194	.033	•	QBEGG	E
Soybean oil (•)	100	32/194		•	QBEGG	E
Diathermic oil	100	23/230	.033	•	QBVGG	V
Hydraulic oil	100	23/230		•	QBVGG	V
Mineral oil	100	23/230	.034	•	QBVGG	V
Sodium sulfatate	15	14/104	.094	•	QQEGG	E
Aluminum sulfatate	30	23/122	.097	•	QQEGG	E
Ammonium sulfatate	10	14/140	.064	•	QQEGG	E
Iron sulfatate	10	23/86	.076	•	QBEGG	E
Copper sulfatate	20	32/86	.082	•	QQVGG	V
Trichloroethylene		14/104	.053	•	QBVGG	V
Perchlroethylene		14/86	.057	•	QBVGG	V

#### Legend

Q = Silicon carbide B = Carbon E = EPDM V = Viton G = AISI 316 (spring, metal components)

(•) A special version may be necessary for this fluid. For additional information, please contact our sales network.

## Commercial Water

### TECHNICAL DATA - NPSH

#### NPSH

The minimum operating values that can be reached at the pump suction end are limited by the onset of cavitation.

Cavitation is the formation of vapor-filled cavities within liquids where the pressure is locally reduced to a critical value, or where the local pressure is equal to, or just below the vapor pressure of the liquid.

The vapor-filled cavities flow with the current and when they reach a higher pressure the vapor contained in the cavities condenses. The cavities collide, generating pressure waves that are transmitted to the walls. These, being subjected to stress cycles, gradually become deformed and yield due to fatigue. This phenomenon, characterized by a metallic noise produced by the hammering on the pipe walls, is called incipient cavitation.

The damage caused by cavitation may be magnified by electrochemical corrosion and a local rise in temperature due to the plastic deformation of the walls. The materials that offer the highest resistance to heat and corrosion are alloy steels, especially austenitic steel. The conditions that trigger cavitation may be assessed by calculating the total net suction head, referred to in technical literature with the acronym NPSH (Net Positive Suction Head).

The NPSH represents the total energy (expressed in feet) of the liquid measured at suction under conditions of incipient cavitation, excluding the vapor pressure (expressed in feet) that the liquid has at the pump inlet.

To find the static height ( $h_z$ ) at which to install the machine under safe conditions, the following formula must be verified:

$$h_p + h_z \geq (\text{NPSHr} + 2 \text{ ft}) + h_f + h_{pv}$$

where:

$h_p$  is the absolute pressure applied to the free liquid surface in the suction tank, expressed in feet of liquid;  $h_p$  is the quotient between the barometric pressure and the specific weight of the liquid.

$h_z$  is the suction lift between the pump axis and the free liquid surface in the suction tank, expressed in feet;  $h_z$  is negative when the liquid level is lower than the pump axis.

$h_f$  is the flow resistance in the suction line and its accessories, such as: fittings, foot valve, gate valve, elbows, etc.

$h_{pv}$  is the vapor pressure of the liquid at the operating temperature, expressed in feet of the liquid.  $h_{pv}$  is the quotient between the  $P_v$  vapor pressure and the liquid's specific weight.

**0.5** is the safety factor.

The maximum possible suction head for installation depends on the value of the atmospheric pressure (i.e. the elevation above sea level at which the pump is installed) and the temperature of the liquid.

To help the user, with reference to water temperature (40°F) and to the elevation above sea level, the following tables show the drop in hydraulic pressure head in relation to the elevation above sea level, and the suction loss in relation to temperature.

<b>Water Temperature (°F)</b>	68	104	140	176	194	230	248
<b>Suction Loss (ft)</b>	-7	2.3	6.6	16.4	24.3	50.5	70.5

<b>Elevation Above Sea Level (ft)</b>	1600	3300	4900	6500	8200	9800
<b>Suction Loss (ft)</b>	1.8	3.6	5.4	7.2	9.0	10.8

To reduce it to a minimum, especially in cases of high suction head (over 13 - 16 feet) or within the operating limits with high flow rates, we recommend using a suction line having a larger diameter than that of the pump's suction port. It is always a good idea to position the pump as close as possible to the liquid to be pumped.

### FURTHER PRODUCT SELECTION AND DOCUMENTATION Intellitronic X

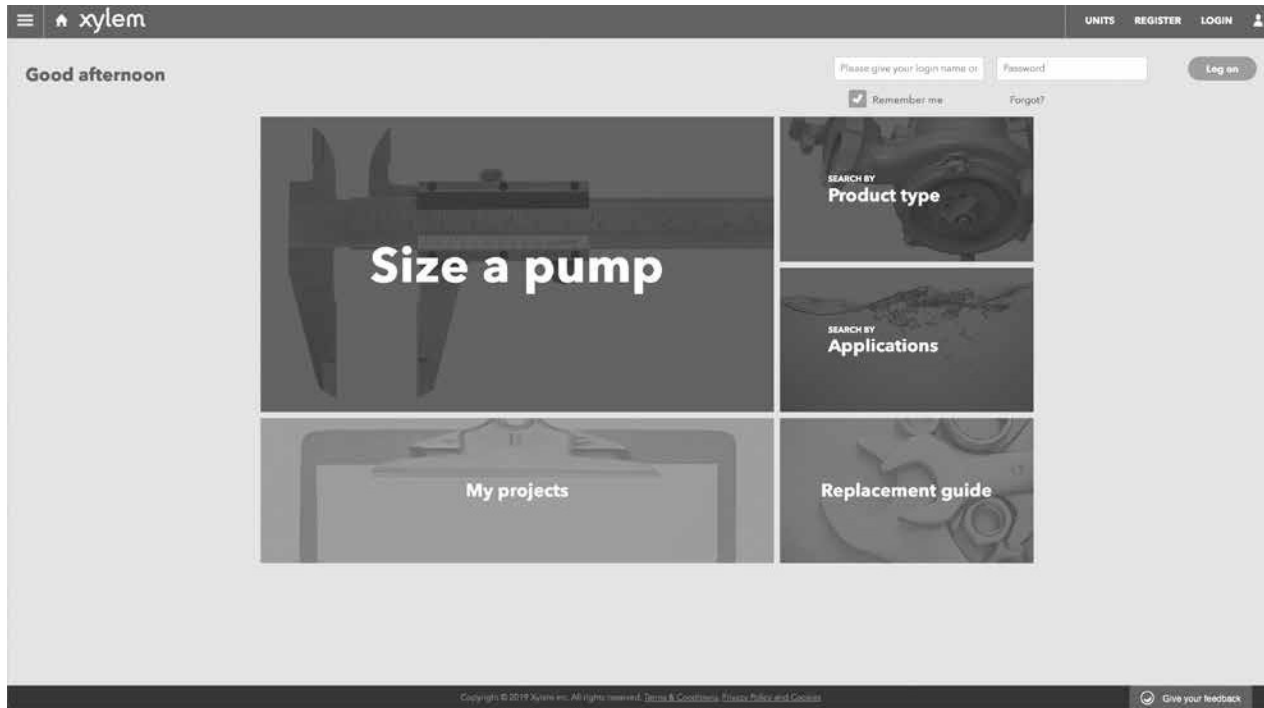

Intellitronic X is pump solution software with multiple search options and helpful project management facilities.

The possibility to search by applications and the detailed information output given makes it easy to make the optimal selection without having detailed knowledge about the Xylem products. The search by application guides users, not familiar with the product range, to the right choice. The detailed output makes it easy to select the optimal pump from the given alternatives.

The search can be made by:

- Application • Product type • Duty point

Intellitronic X gives a detailed output:

- List with search results
- Performance curves (flow, head, power, efficiency, NPSH)
- Motor data
- Dimensional drawings (can be downloaded in dxf format)
- Options
- Data sheet printouts
- Document downloads include dxf files

The best way to work with Intellitronic X is to create a personal account. This makes it possible to:

- Set own standard units
- Create and save projects
- Share projects with other Intellitronic X users

Every registered user has a proper space, where all projects are saved.

For more information about Intellitronic X please contact our sales network or visit [www.gouldsintellitronic.com](http://www.gouldsintellitronic.com).

**NOTES**

# Xylem |'zīləm|

- 1) The tissue in plants that brings water upward from the roots;
- 2) a leading global water technology company.

We're a global team unified in a common purpose: creating advanced technology solutions to the world's water challenges. Developing new technologies that will improve the way water is used, conserved, and re-used in the future is central to our work. Our products and services move, treat, analyze, monitor and return water to the environment, in public utility, industrial, residential and commercial building services settings. Xylem also provides a leading portfolio of smart metering, network technologies and advanced analytics solutions for water, electric and gas utilities. In more than 150 countries, we have strong, long-standing relationships with customers who know us for our powerful combination of leading product brands and applications expertise with a strong focus on developing comprehensive, sustainable solutions.

**For more information on how Xylem can help you, go to [www.xylem.com](http://www.xylem.com)**



Xylem Inc.  
1 Goulds Drive  
Auburn, NY 13021  
Phone: (866) 673-0428  
Fax: (888) 322-5877  
[www.xylem.com/goulds](http://www.xylem.com/goulds)

Goulds is a registered trademark of Goulds Pumps, Inc. and is used under license.  
© 2021 Xylem Inc. BeHM R13 April 2021