



ResiBoost

COMPLETE PACKAGED RESIDENTIAL CONSTANT PRESSURE
BOOSTING SYSTEM, FOR THE WAY YOU LIVE

FEATURES

Powered for Continuous Operation: All ratings are within the working limits of the motor as recommended by the motor manufacturer. Pump can be operated continuously without damage to the motor.

VFD: Built-in protection against various system and electrical faults. Comes with internal transducer with digital indicator, additional parts not necessary. Pre-wired to e-HM pump.

Energy Savings: Precise speed control to operate pump for best energy efficiency.

Ease of installation: Complete system with pump, motor and controller assembled. Tank included separate from assembly for shipping. Plug and Play compact system.

Built-in Check Valve: Completely assembled ResiBoost includes a uniquely designed fitting including a spring loaded check valve.

Built-in Memory: Stored data - operating hours, number of starts, connection to the power supply, faults.

Electrical Protection: Protects against over-current, incorrect power supply, and short circuit.

Display: Control with LCD display and simple push button settings.

Stainless Steel Pump: e-HM series stainless steel pump with small footprint designed for longer life.

Offerings: Six SKU's to cover all residential boosting applications up to 35 GPM.

Model	Pump Designation	Max GPM	Stages	Output Phase	Output Voltage	Weight
13159RB115	13 GPM AT 60 PSI	22	5	1	115	30
2294RB115	22 GPM AT 38 PSI	40	3			
13120RB230	13 GPM AT 48 PSI	22	4			
22125RB230	22 GPM AT 50 PSI	40	4	3	230	
13150RB3	13 GPM AT 65 PSI	22	5			
22157RB3	22 GPM AT 68 PSI	40	5			

NUMBER CODE

13 159 RB 115

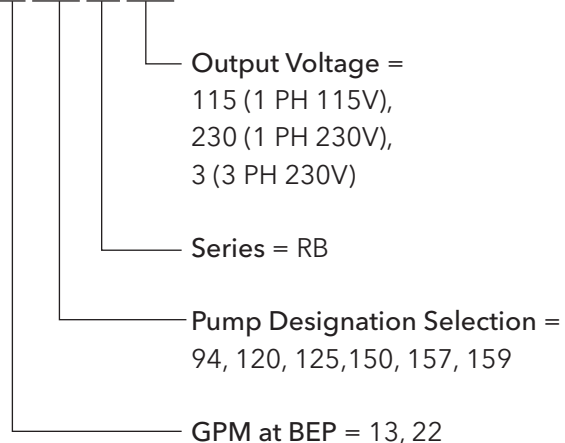

INCLUDED IN KIT

Kit	Pump	Controller	Fitting	Tank
13159RB115	3HM05N07M6BQQE	RB111512	15K112	V2L
2294RB115	5HM03N07M6BQQE			
13120RB230	3HM04N05M6FQQE	RB12309		
22125RB230	5HM04N11M6FQQE			
13150RB3	3HM05N07T6PQQE	RB32309		
22157RB3	5HM05N15T6PQQE			

THE RESIBOOST ADVANTAGE

The ResiBoost constant pressure system provides an economical solution for municipal water users that suffer from low pressure. In addition the ResiBoost constant pressure system can also be used for applications requiring repressurizing water from a storage tank. As your household water needs change, our drive will change the speed of the motor to accommodate the need.

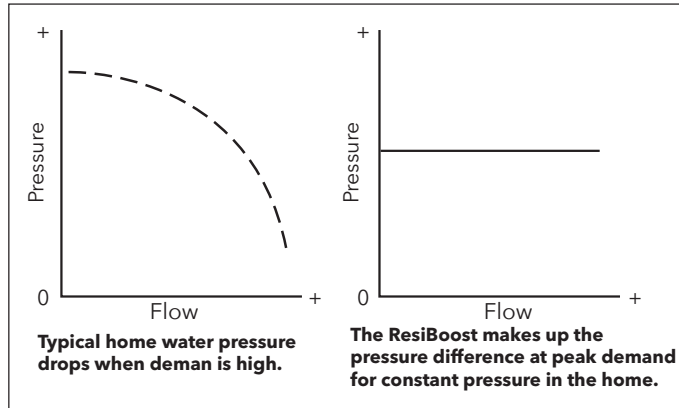

LOSS CURVE

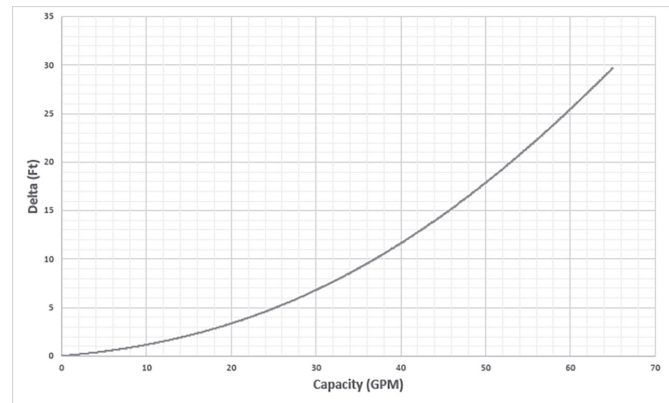

Note: Above curve reflects friction loss of the controller as water passes through the controller.

RESIBOOST CONTROLLER



FEATURES

- Input Power:** Single Phase 115 and 230 V
- Output Power:** Single Phase 115 and 230 V, 3 phase 230 V
- Programming:** Pre-programmed
- Input Controls:** HMI with push button control
- Signal Lights:** Red LED
- Protection Against:** No Water, Motor Over Current, Open Lead, Low System Pressure, Over Heating, Short Circuit, Over Voltage, Under Voltage
- Temperature Rating:** 32° - 122°F
- Approvals:** cCSA_{US}, NSF
- Enclosure:** Type 3
- Power Lead:** 230V plug (NEMA 6-20) on 230 V, 115 V plug (NEMA 5-15) on 115 V selections

ResiBoost Controller Part #	Input Voltage	Output Voltage	Max Amps	Weight lbs
RB111512	1/115	1/115	12	6.4
RB12309	1/230	1/230	9	
RB32309	1/230	3/230	9	

* ResiBoost controller cannot be used on all surface motors. Check IOM for correct applications.

DIMENSIONS

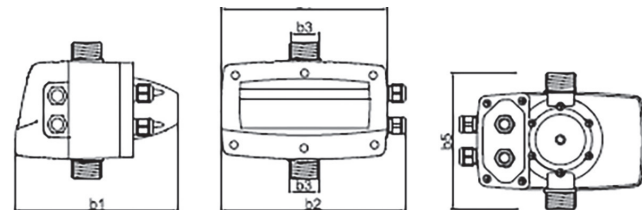

Model	lbs	b1 [in]	b2 [in]	b3 [in]	b4 [in]	b5 [in]
1Ø 3Ø	6.4	9.1	10.4	1¼" MNPT	9.4	7.7

FAMILY CURVE

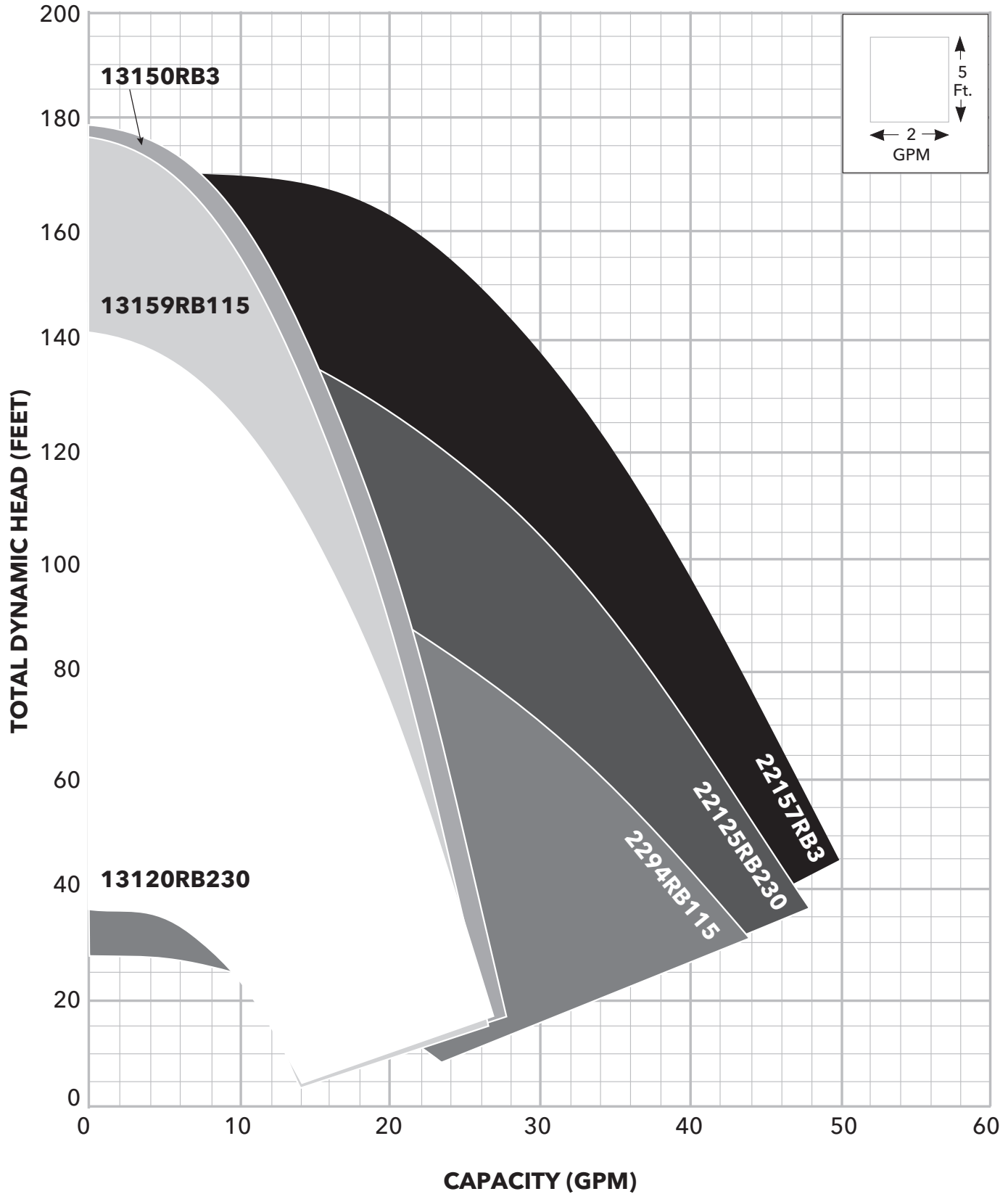

PERFORMANCE CURVES

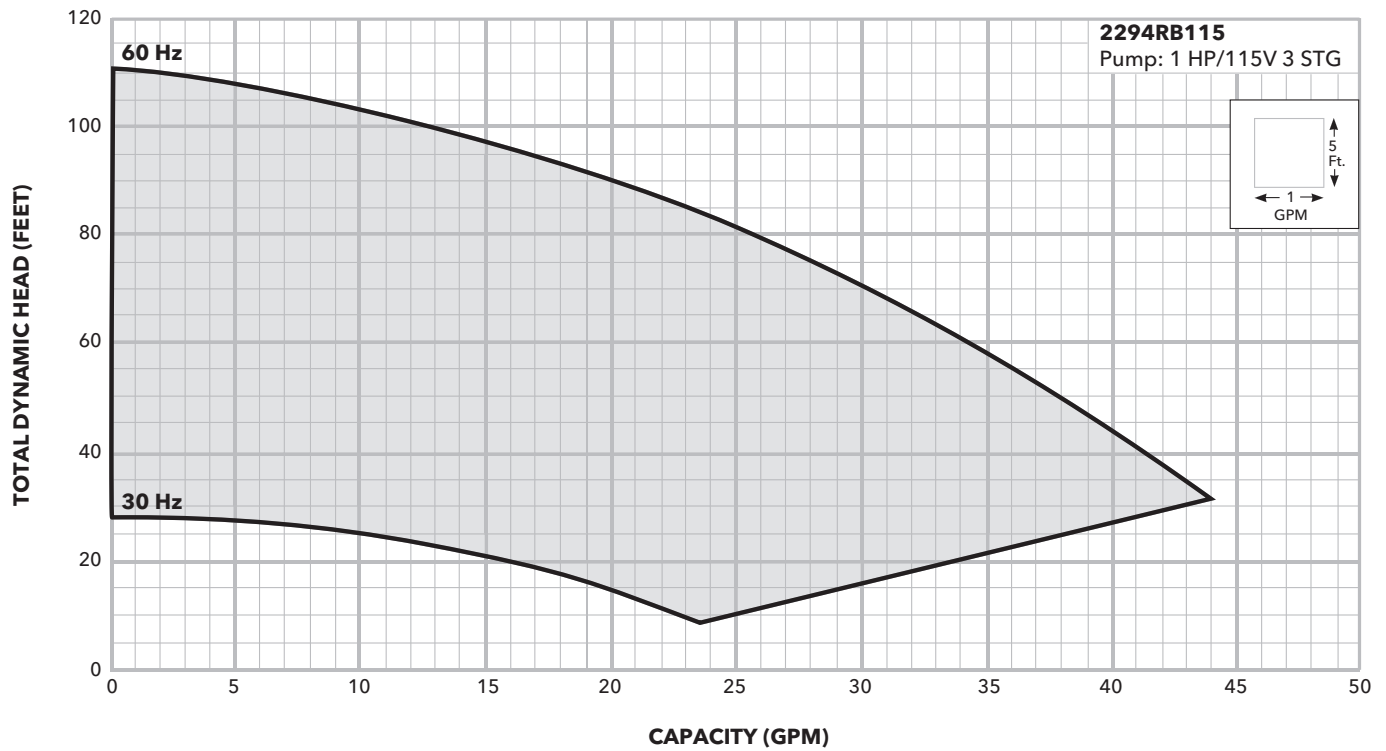
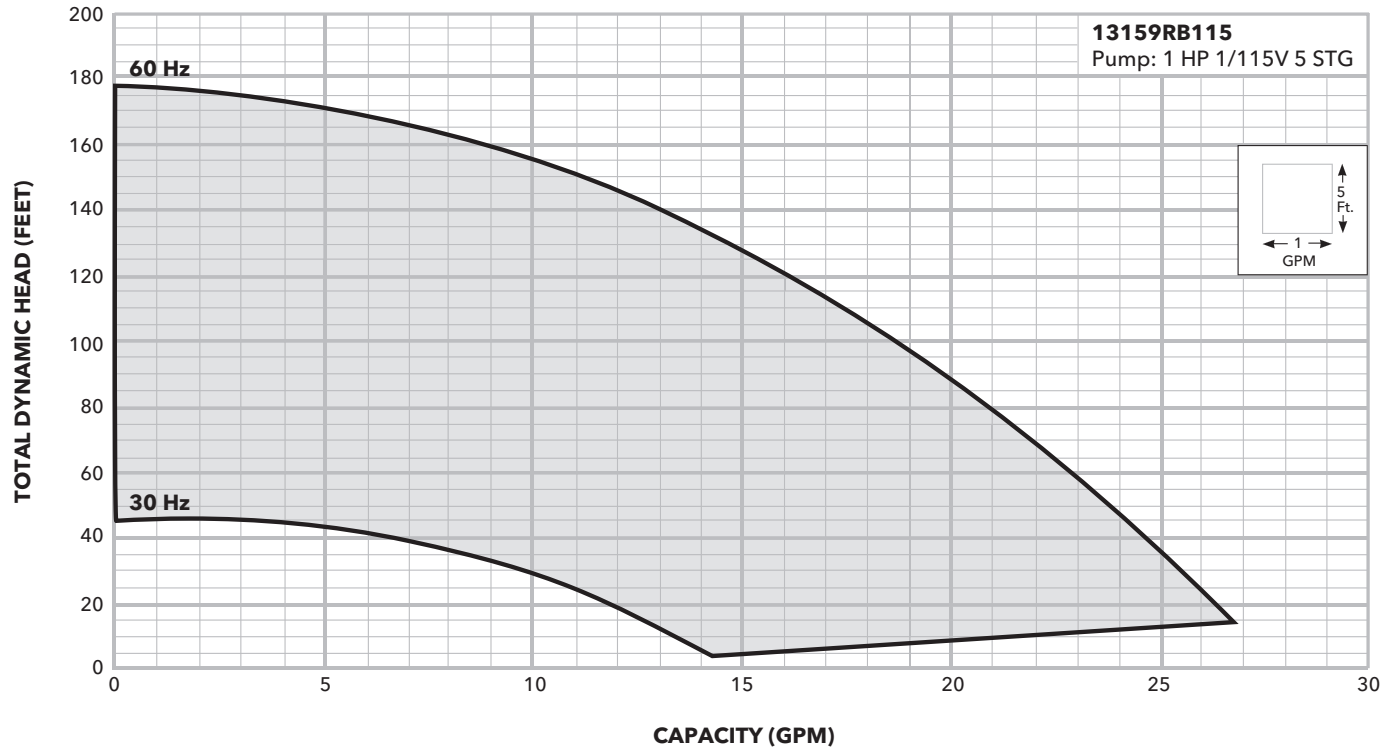

PERFORMANCE CURVES

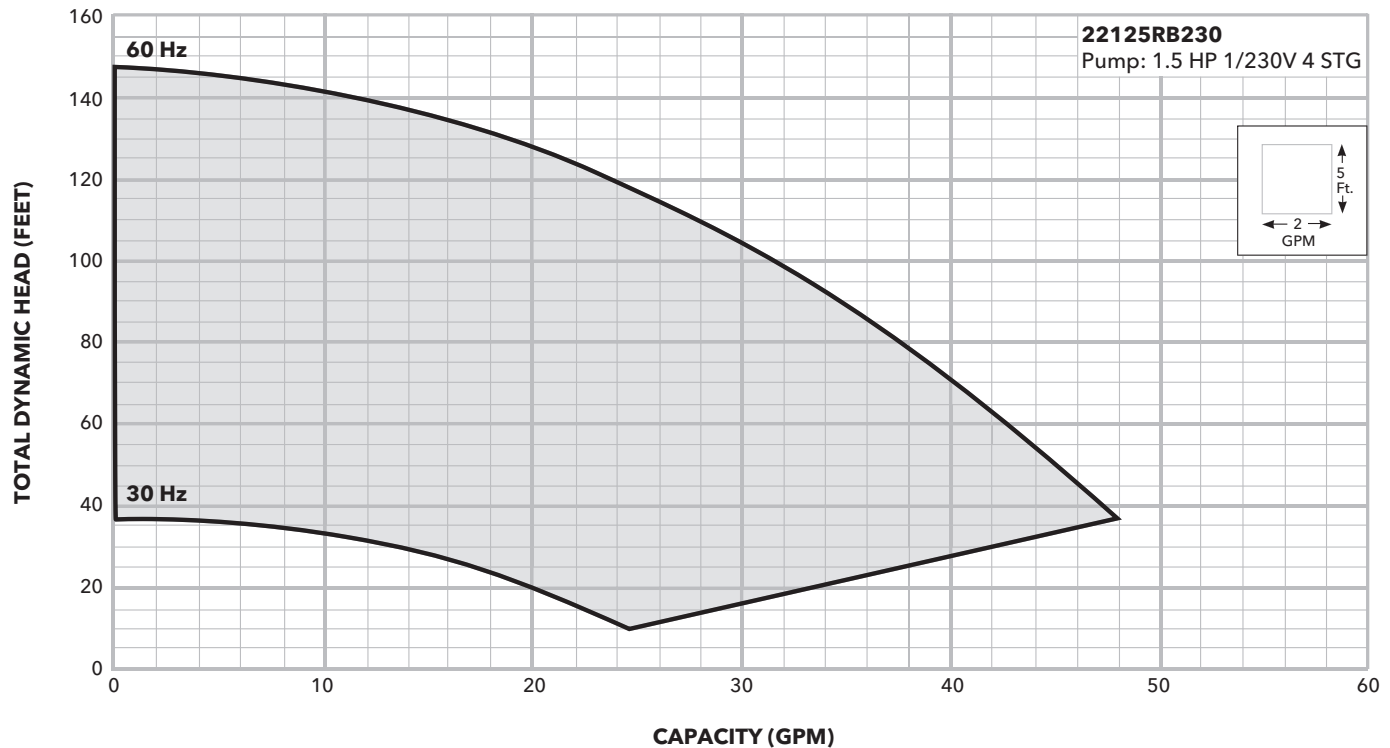
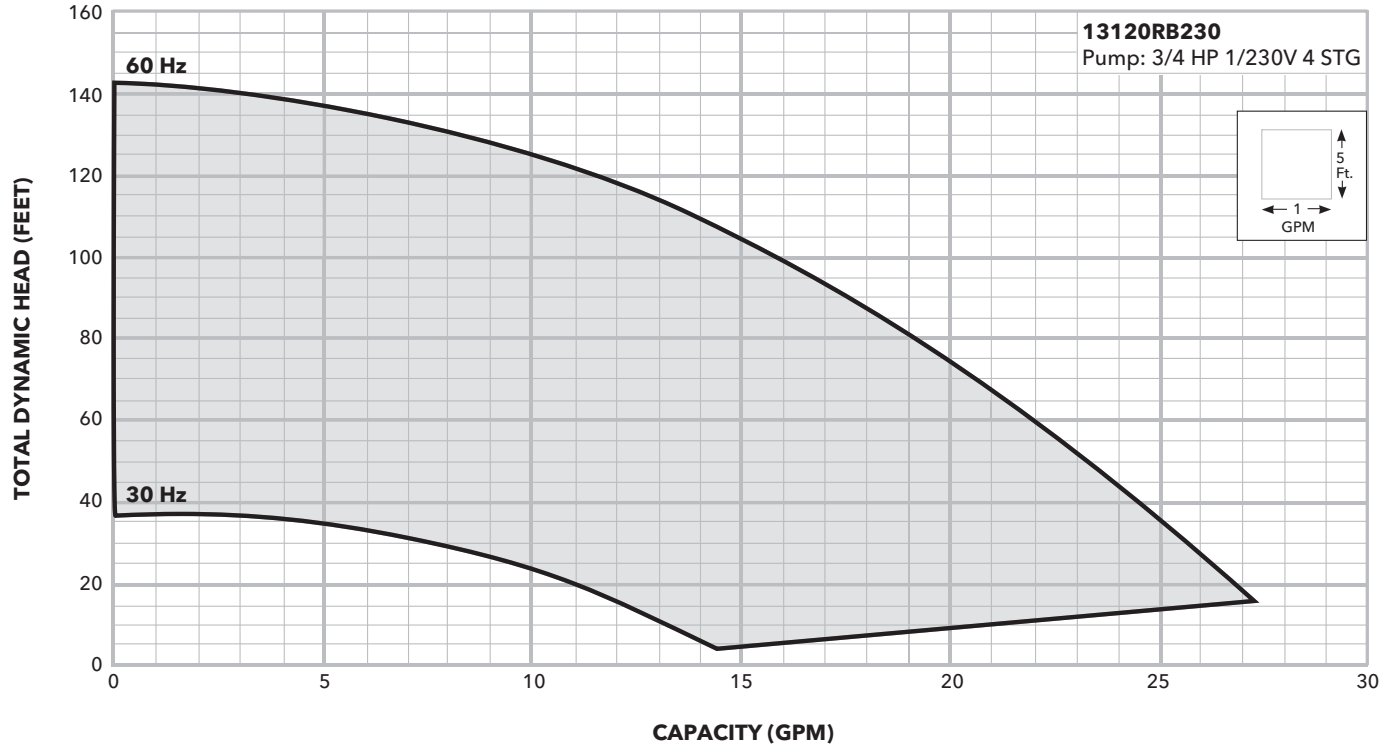

PERFORMANCE CURVES

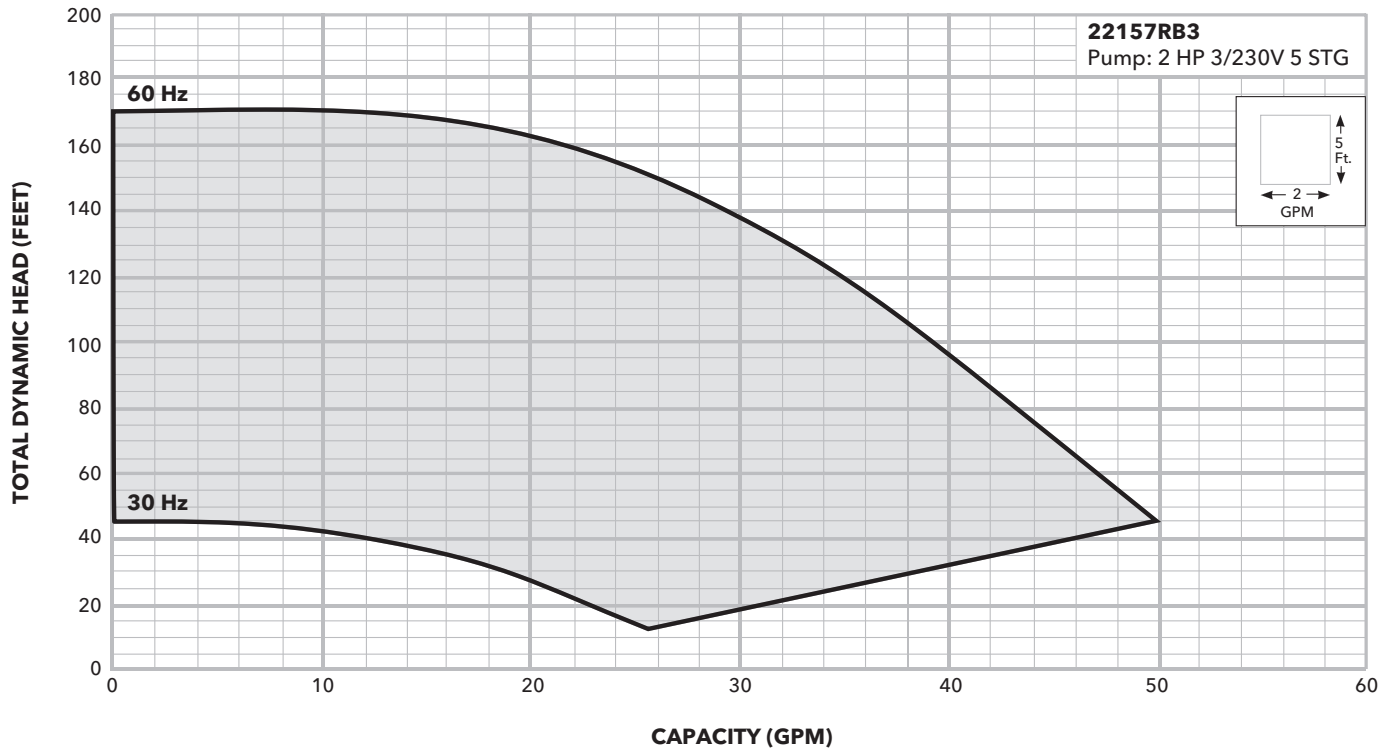
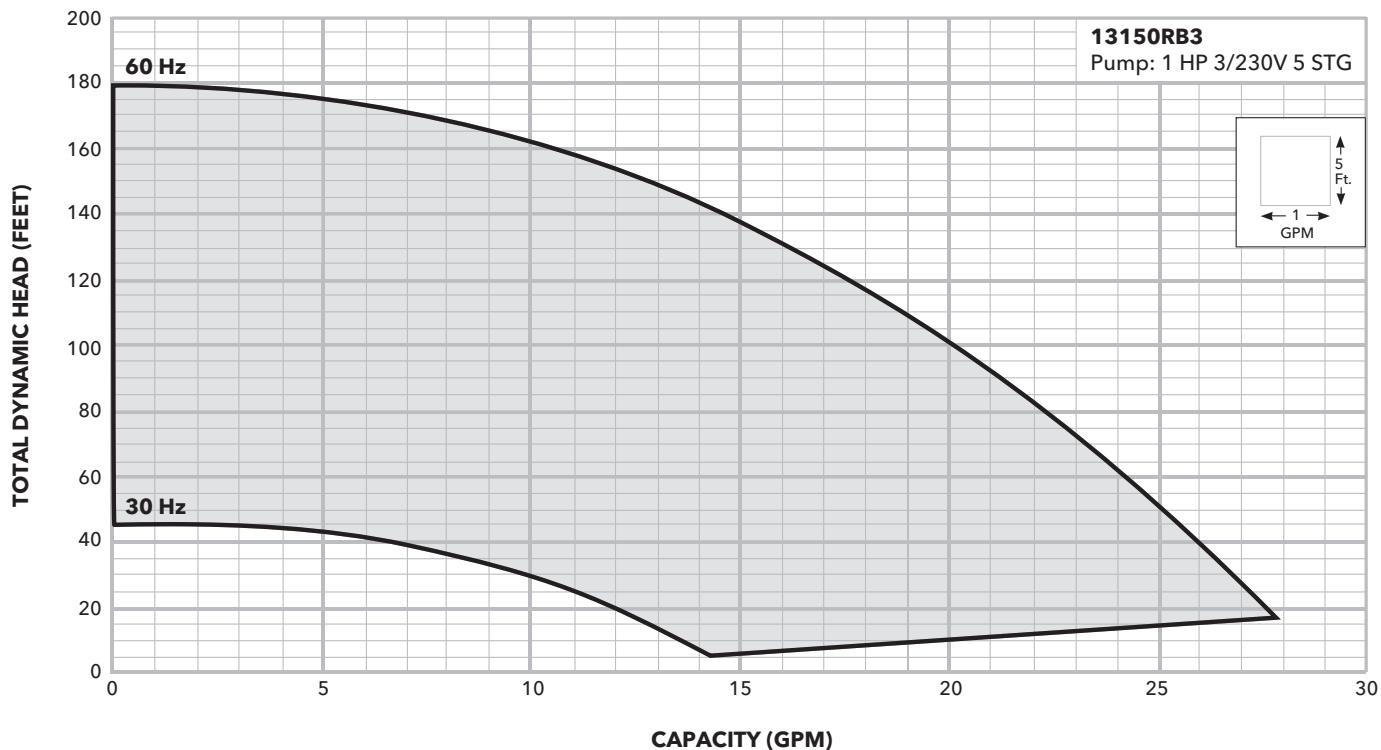

NOTE: For complete pump information, please reference the BeHM R11 on www.goulds.com.

TYPICAL MUNICIPAL WATER INSTALLATION

No.	Component	Included in the kit
1	Electric pump	✓
2	Union with check valve	✓
3	Priming port	
4	Vacuum pressure gauge	
5	Discharge pressure gauge	
6	Union	
7	Pressure relief valve	
8	Gate valve	
9	Diaphragm tank	✓
10	ResiBoost controller	✓

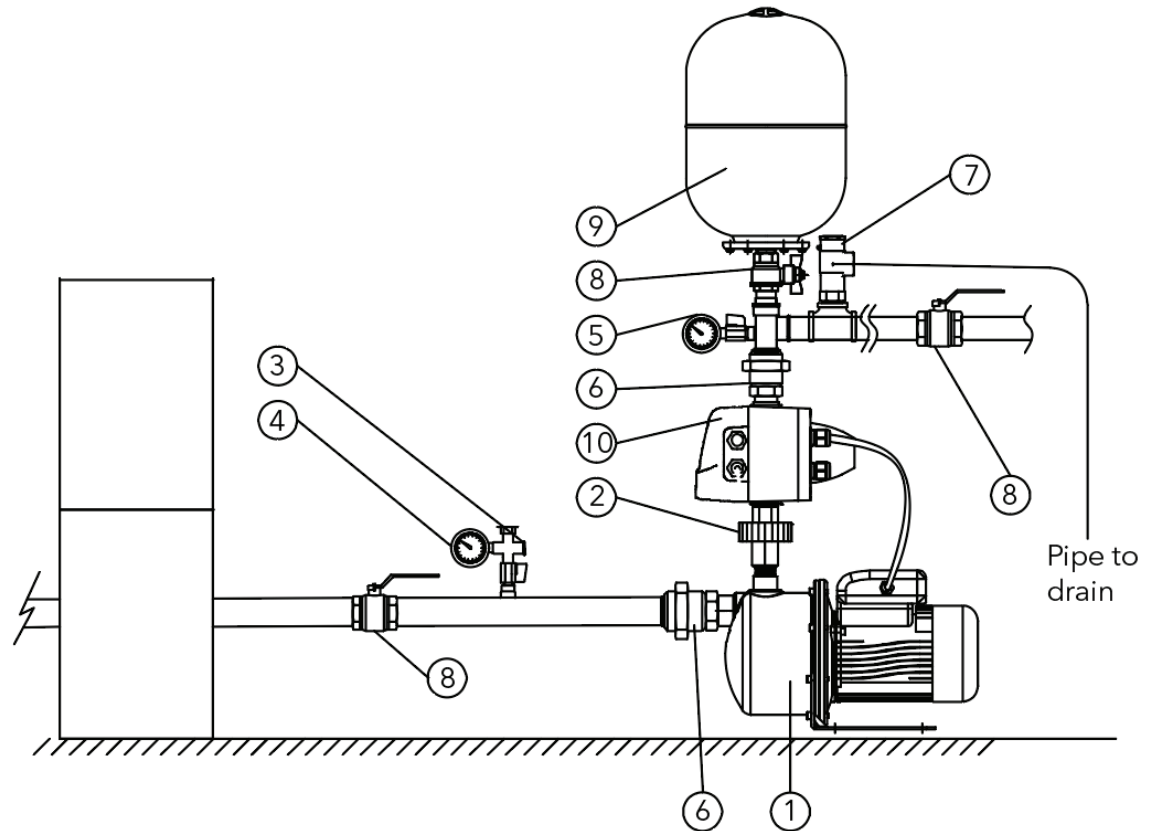

xylem
Let's Solve Water

Xylem Inc.
2881 East Bayard Street Ext., Suite A
Seneca Falls, NY 13148
Phone: (866) 325-4210 • Fax: (888) 322-5877
www.xylem.com/goulds

Goulds is a registered trademark of Goulds Pumps, Inc. and is used under license.
© 2021 Xylem Inc. BRESIBOOST R3 May 2021