

P400 Series - 22 and 25mm Versions

Triplex Ceramic
Plunger Pump
Operating Instructions/
Repair and Service Manual

For Models:

P420

P420-0011

P420-0021

P422

P423

P425

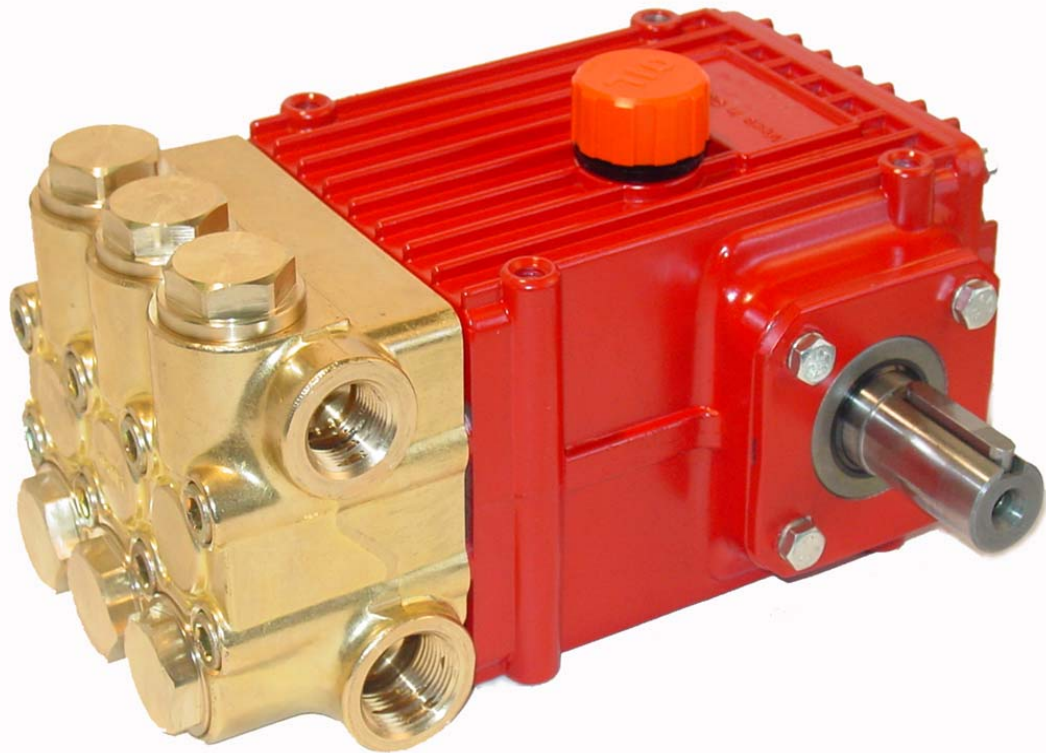

GIANT

Contents:

Installation Instructions:	page 2
Pump Specifications (except P425):	pages 3-5
Exploded View:	page 6
Parts List/Kits:	page 7
Pump Specifications (P425):	page 8
Repair Instructions/Torque Specs.:	pages 9-10
Trouble Shooting Chart:	page 11
Recommended Spare Parts List:	page 11
Dimensions:	back page
Warranty Information:	back page

Updated 11/09

INSTALLATION INSTRUCTIONS

Installation of the Giant Industries, Inc., pump is not a complicated procedure, but there are some basic steps common to all pumps. The following information is to be considered as a general outline for installation. If you have unique requirements, please contact Giant Industries, Inc. or your local distributor for assistance.

1. The pump should be installed flat on a base to a maximum of a 15 degree angle of inclination to ensure optimum lubrication.
2. The inlet to the pump should be sized for the flow rate of the pump with no unnecessary restrictions that can cause cavitation. Teflon tape should be used to seal all joints. If pumps are to be operated at temperatures in excess of 160° F, it is important to insure a positive head to the pump to prevent cavitation.
3. The discharge plumbing from the pump should be properly sized to the flow rate to prevent line pressure loss to the work area. It is essential to provide a safety bypass valve between the pump and the work area to protect the pump from pressure spikes in the event of a blockage or the use of a shut-off gun.
4. Use of a dampener is necessary to minimize pulsation at drive elements, plumbing, connections, and other system areas. The use of a dampener with Giant Industries, Inc. pumps is optional, although recommended by Giant Industries, Inc. to further reduce system pulsation. Dampeners can also reduce the severity of pressure spikes that occur in systems using a shut-off gun. A dampener must be positioned downstream from the unloader.
5. Crankshaft rotation on Giant Industries, Inc. pumps should be made in the direction designated by the arrows on the pump crankcase. Reverse rotation may be safely achieved by following a few guidelines available upon request from Giant Industries, Inc. Required horsepower for system operation can be obtained from the charts on pages 3-5 and page 8.
6. Before beginning operation of your pumping system, remember: Check that the crankcase and seal areas have been properly lubricated per recommended schedules. Do not run the pump dry for extended periods of time. Cavitation will result in severe damage. Always remember to check that all plumbing valves are open and that pumped media can flow freely to the inlet of the pump.

Finally, remember that high pressure operation in a pump system has many advantages. But, if it is used carelessly and without regard to its potential hazard, it can cause serious injury.

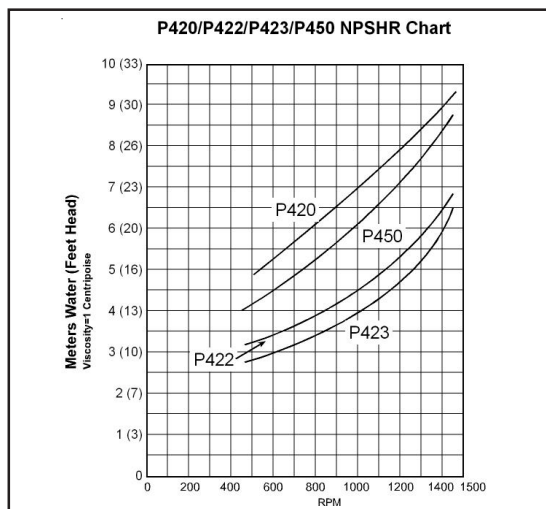

IMPORTANT OPERATING CONDITIONS

Failure to comply with any of these conditions invalidates the warranty.

1. Prior to initial operation, add oil to the crankcase so that oil level is between the two lines on the oil dipstick. **DO NOT OVERFILL.**

Use SAE 80-90W or Giant's p/n 01154 or ISO VG220 industrial gear lube oil

Crankcase oil should be changed after the first 50 hours of operation, then at regular intervals of 500 hours or less depending on operating conditions.
2. Pump operation must not exceed rated pressure, volume, or RPM. A pressure relief device must be installed in the discharge of the system.
3. Acids, alkalines, or abrasive fluids cannot be pumped unless approval in writing is obtained before operation from Giant Industries, Inc.
4. Run the pump dry approximately 10 seconds to drain the water before exposure to freezing temperatures.

Specifications

Models P420A, P420A-0011, P420A-0021

	U.S.	(Metric)
Volume	Up to 12.8 GPM	(48.4 LPM)
Discharge Pressure	Up to 2175 PSI	(150 bar)
Inlet Pressure	-4.35 to 145 PSI	(-.3 to 10 bar)
Stroke	0.945"	(24mm)
RPM	Up to 1450 RPM	
Plunger Diameter	0.98"	(25mm)
Temperature of Pumped Fluids	Up to 160 °F	(71 °C)
Inlet Ports		(2) 1" NPT
Discharge Ports		(2) 3/4" NPT
Shaft Rotation	Top of pulley towards fluid end	
Crankshaft Diameter	1.1"	(28mm)
Key Width	0.315"	(8mm)
Shaft Mounting	Either side ¹	
Weight	36 lbs. 8oz	(16.6 kg)
Crankcase Capacity	27 fl.oz.	(0.8 liters)
Volumetric Efficiency @ 1450	(0.95)	
Mechanical Efficiency @ 1450	(0.86)	

Consult the factory for special requirements that must be met if the pump is to operate beyond one or more of the limits specified above.

NOTES:

In order to drive the pump from the side opposite the present shaft extension, simply remove the valve casing from the crankcase and rotate the pumps 180 degrees to the desired position. Be certain to rotate the seal case (item #20) as well, so that the weep holes are down at the six o'clock position. Exchange the oil fill and the oil drain plugs, also. Refer to the repair instructions as necessary for the proper assembly sequence.

P420 HORSEPOWER REQUIREMENTS					
RPM	GPM	1000 PSI	1500 PSI	1700 PSI	2175 PSI
785	6.9	4.8	7.1	8.1	10.4
900	7.9	5.4	8.2	9.3	11.9
1010	8.9	6.1	9.2	10.4	13.4
1120	9.9	6.8	10.2	11.6	14.9
1240	10.9	7.5	11.3	12.8	16.4
1450	12.8	8.8	13.2	15.0	19.2

HORSEPOWER RATINGS:

The rating shown are the power requirements for the pump. Gas engine power outputs must be approximately twice the pump power requirements shown above.

We recommend a 1.15 service factor be specified when selecting an electric motor as the power source. To compute specific pump horsepower requirements, use the following formula:

$$HP = (GPM \times PSI) / 1450$$

SPECIAL NOTE:

The theoretical gallons per revolution (gal/rev) is 0.0088. To find specific outputs at various RPM, use the formula: $GPM = 0.0088 \times RPM$

Specifications

Model P422

	U.S.	(Metric)
Volume	Up to 9.9 GPM	(37.3 LPM)
Discharge Pressure Continuous	Up to 2600 PSI	(180 bar)
Discharge Pressure Intermittent	Up to 3000 PSI	(206.8 bar)
Inlet Pressure	-4.35 to 145 PSI	(-.3 to 10 bar)
Stroke	0.94"	(24mm)
RPM	Up to 1450 RPM	
Plunger Diameter	0.87"	(22mm)
Temperature of Pumped Fluids	Up to 160 °F	(71 °C)
Inlet Ports		(2) 1" NPT
Discharge Ports		(2) 3/4" NPT
Shaft Rotation	Top of pulley towards manifold	
Crankshaft Diameter	1.102"	(28mm)
Key Width315"	(8mm)
Shaft Mounting	Either side ¹	
Weight	36 lbs. 8oz	(16.6 kg)
Crankcase Capacity	27 fl.oz.	(0.8 liters)
Volumetric Efficiency @ 1450	(0.95)	
Mechanical Efficiency @ 1450	(0.83)	

Consult the factory for special requirements that must be met if the pump is to operate beyond one or more of the limits specified above.

NOTES:

In order to drive the pump from the side opposite the present shaft extension, simply remove the valve casing from the crankcase and rotate the pumps 180 degrees to the desired position. Be certain to rotate the seal case (item #20) as well, so that the weep holes are down at the six o'clock position. Exchange the oil fill and the oil drain plugs, also. Refer to the repair instructions as necessary for the proper assembly sequence.

P422 HORSEPOWER REQUIREMENTS					
RPM	GPM	1000 PSI	1500 PSI	2610 PSI	3000 PSI*
900	6.1	4.2	6.3	11.0	12.6
1050	7.2	5.0	7.5	13.0	14.9
1160	7.9	5.4	8.2	14.2	16.3
1300	8.9	6.1	9.2	16.0	18.4
1450	9.9	6.8	10.2	17.8	20.5

Intermittent duty only

SPECIAL NOTE:
The theoretical gallons per revolution (gal/rev) is 0.00683. To find specific outputs at various RPM, use the formula: $GPM = 0.00683 \times RPM$

HORSEPOWER RATINGS:

The rating shown are the power requirements for the pump. Gas engine power outputs must be approximately twice the pump power requirements shown above.

We recommend a 1.15 service factor be specified when selecting an electric motor as the power source. To compute specific pump horsepower requirements, use the following formula:

$$HP = (GPM \times PSI) / 1450$$

Specifications Model P423

	U.S.	(Metric)
Volume	Up to 8.2 GPM	(31.1 LPM)
Discharge Pressure	Up to 2900 PSI	(200 bar)
Inlet Pressure	-4.35 to 145 PSI	(-.3 to 10 bar)
Stroke	0.79"	(20mm)
RPM		Up to 1450 RPM
Plunger Diameter	0.87"	(22mm)
Temperature of Pumped Fluids	Up to 160 °F	(71 °C)
Inlet Ports		(2) 1" NPT
Discharge Ports		(2) 3/4" NPT
Shaft Rotation	Top of pulley towards manifold	
Crankshaft Diameter	1.102"	(28mm)
Key Width315"	(8mm)
Shaft Mounting	Either side ¹	
Weight	36 lbs. 8oz	(16.6 kg)
Crankcase Capacity	27 fl.oz.	(0.8 liters)
Volumetric Efficiency @ 1450	(0.95)	
Mechanical Efficiency @ 1450	(0.83)	

Consult the factory for special requirements that must be met if the pump is to operate beyond one or more of the limits specified above.

NOTES:

In order to drive the pump from the side opposite the present shaft extension, simply remove the valve casing from the crankcase and rotate the pumps 180 degrees to the desired position. Be certain to rotate the seal case (item #20) as well, so that the weep holes are down at the six o'clock position. Exchange the oil fill and the oil drain plugs, also. Refer to the repair instructions as necessary for the proper assembly sequence.

P423HORSEPOWER REQUIREMENTS					
RPM	GPM	1000 PSI	1500 PSI	2000 PSI	2900 PSI
900	5.1	3.5	5.3	7.0	10.2
1050	5.9	4.1	6.1	8.1	11.8
1160	6.6	4.6	6.8	9.1	13.2
1300	7.4	5.1	7.7	10.2	14.8
1450	8.2	5.7	8.5	11.3	16.4

HORSEPOWER RATINGS:

The rating shown are the power requirements for the pump. Gas engine power outputs must be approximately twice the pump power requirements shown above.

We recommend a 1.15 service factor be specified when selecting an electric motor as the power source. To compute specific pump horsepower requirements, use the following formula:

$$HP = (GPM \times PSI) / 1450$$

SPECIAL NOTE:

The theoretical gallons per revolution (gal/rev) is 0.00566. To find specific outputs at various RPM, use the formula: $GPM = 0.00566 \times RPM$

EXPLODED VIEW - P420 / P420-0011 / P420-0021 / P422 / P423 AND P425 PUMPS

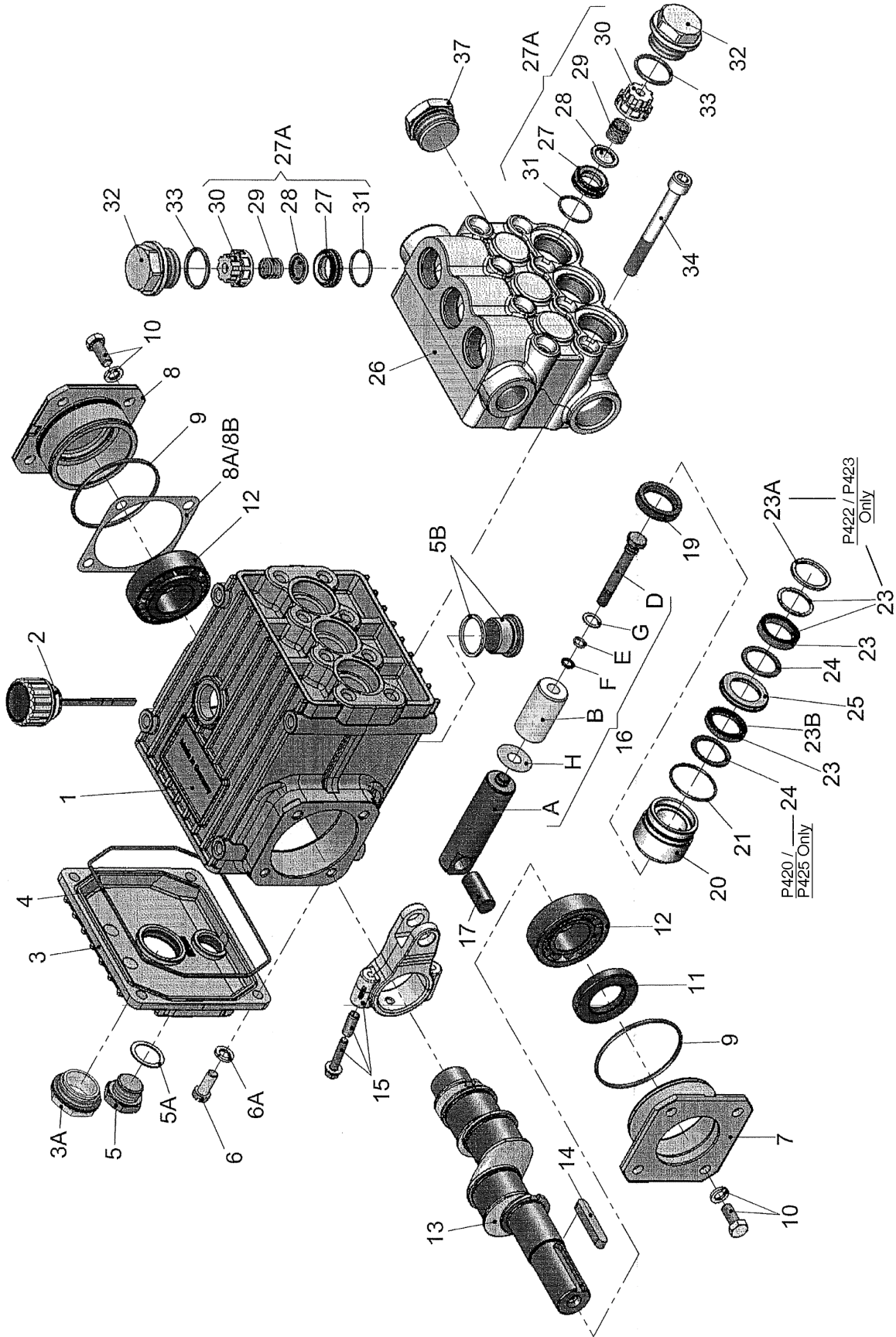

P420 / P420-0011 / P420-0021 / P422 / P423 and P425 SPARE PARTS LIST

A = P420 B = P422 G = P423 H = P425 J = P420-0011 K = P420-0021

ITEM	PART	DESCRIPTION	QTY.	ITEM	PART	DESCRIPTION	QTY.
1	08377	Crankcase	1	16G	07258	Copper Washer	3
2	08378	Oil Fill Plug with Gasket	1	16H	06431	Oil Scraper	3
3	06479	Crankcase cover	1	17	06790	Crosshead Pin	3
3A	07186	Oil Sight Glass w/ Gasket	1	19	05444	Oil Seal	3
4	08380	O-Ring	1	20	05443	Seal Case (A, H, J & K)	3
5	07109	Oil Drain Plug	1	20	05601	Seal Case (B & G)	3
5A	07182	Gasket for Oil Drain Plug	1	21	07266	O-Ring (A, B, G, & H)	3
5B	08092	Plug with Gasket	1	21	07266-0001	O-Ring, Viton (J & K)	3
6	01010	Screw	4	23	12254	V-Sleeve, 25mm (A & H)	3
6A	01011-0400	Spring Washer	4	23	12254-0010	V-Sleeve, 25mm, Viton, (J)	3
7	05290	Bearing Cover Open	1	23	12254-0020	V-Sleeve, 25mm, Teflon, (K)	3
8	05291	Bearing Cover Closed	1	23	06249	V-Sleeve with Support Ring,	
8A	05292	Shim	1			22mm (B & G)	3
8B	05293	Shim (May not be present)	1	23A	06251	Spacer Ring (B & G)	3
9	01016	O-Ring	2	23B	12255	Weep Seal (A & H)	3
10	07114	Screw with Washer	8	23B	12255-0010	Weep Seal, Viton (J)	3
11	07459	Radial Shaft Seal	1	23B	12255-0020	Weep Seal, Teflon (K)	3
12	05350	Taper Roller Bearing	2	23B	13390	Weep Seal (B & G)	3
13	08475	Crankshaft (A, B, J & K)	1	24	08376	Pressure Ring (A, H, J & K)	6
13	08482	Crankshaft (G & H)	1	24	06252	Pressure Ring (B & G)	3
14	08091	Fitting Key	1	25	08394	Weep Return Ring (A, H, J & K)	3
15	08390	Connecting Rod Assembly	3	25	06254	Weep Return Ring (B & G)	3
15B	05349	Connecting Rod Screw	6	26	08395	Manifold	1
15C	05348	Adapter Sleeve	6	27A	08408	Valve Assembly (A, B, G & H)	6
16	05351	Plunger Assy., 25mm, (A & H)		27A	08408-0001	Valve Assembly (J & K)	6
		For items 16A-16H	3	27	08370	Valve Seat	6
16	05351-0001	Plunger Assy., 25mm, (J & K)		28	06791-0100	Valve Plate	6
		For items 16A-16H	3	29	06377-0100	Valve Spring	6
16	05353	Plunger Assy., 22mm, (B & G)		30	08372	Valve Spring Retainer	6
		For items 16A-16H	3	31	07212	O-Ring (A, B, G & H)	6
16A	05352	Plunger Base	3	31	07212-0001	O-Ring, Viton (J & K)	6
16B	08398	Plunger Pipe, 25mm (A, H, J & K)	3	32	08373	Plug	6
16B	06247	Plunger Pipe, 22mm (B & G)	3	33	07214	O-Ring (A, B, G & H)	6
16D	08399	Tensioning Screw	3	33	07214-0001	O-Ring, Viton (J & K)	6
16E	07023	O-Ring	3	34	08396	Cap Screw	8
16F	07203	Backup Ring	3				

P420 / P420-0011 / P420-0021 / P422 / P423 and P425 REPAIR KITS

Plunger Packing Kits

P420, P425 - # 09140

Item	Part #	Description	Qty
21	07266	O-Ring	3
23	12254	V-Sleeve	3
23B	12255	Weep Seal	3
24	08376	Pressure Ring	6

Valve Assembly Kit

P420, P422, P423, P425 - # 09143

Item	Part #	Description	Qty.
27A	08408	Valve Assembly, Complete	6
33	07214	O-Ring	6

Plunger Packing Kit

P422, P423 - # 09295

Item	Part #	Description	Qty
21	07266	O-Ring	3
23	06249	V-Sleeve with Support Ring	3
23B	13390	Weep Seal	3
24	06252	Pressure Ring	3

Oil Seal Kit

P400 Series - # 09641

Item	Part #	Description	Qty
19	05444	Oil Seal	3

Optional Viton Plunger Packing Kit

P420-0011 - # 09140-0011

Item	Part #	Description	Qty
21	07266-0001	O-Ring, Viton	3
23	12254-0010	V-Sleeve, Viton	3
23B	12255-0010	Weep Seal, Viton	3
24	08376	Pressure Ring	6

Optional Viton Valve Assembly Kit

P420, P422, P423, P425 - # 09143-0001

Item	Part #	Description	Qty.
27A	08408-0001	Valve Assembly, Complete	6
33	07214-0001	O-Ring	6

Optional Teflon Plunger Packing Kit

P420-0021 - # 09140-0021

Item	Part #	Description	Qty
21	07266-0001	O-Ring, Viton	3
23	12254-0020	V-Sleeve, Teflon	3
23B	12255-0020	Weep Seal, Teflon	3
24	08376	Pressure Ring	3

Specifications Model P425

	U.S.	(Metric)
Volume	Up to 10.7 GPM	(40.6 LPM)
Discharge Pressure	Up to 2465 PSI	(170 bar)
Inlet Pressure	-4.35 to 145 PSI	(-.3 to 10 bar)
Stroke	0.787"	(20mm)
RPM		Up to 1450 RPM
Plunger Diameter	0.98"	(25mm)
Temperature of Pumped Fluids	Up to 160 °F	(71 °C)
Inlet Ports		(2) 1" NPT
Discharge Ports		(2) 3/4" NPT
Shaft Rotation	Top of pulley towards manifold	
Crankshaft Diameter	1.102"	(28mm)
Key Width315"	(8mm)
Shaft Mounting	Either side ¹	
Weight	36 lbs. 11oz	(16.64 kg)
Crankcase Capacity	27 fl.oz.	(0.8 liters)
Volumetric Efficiency @ 1450		(0.95)
Mechanical Efficiency @ 1450		(0.83)

Consult the factory for special requirements that must be met if the pump is to operate beyond one or more of the limits specified above.

NOTES:

In order to drive the pump from the side opposite the present shaft extension, simply remove the valve casing from the crankcase and rotate the pumps 180 degrees to the desired position. Be certain to rotate the seal case (item #20) as well, so that the weep holes are down at the six o'clock position. Exchange the oil fill and the oil drain plugs, also. Refer to the repair instructions as necessary for the proper assembly sequence.

P425 HORSEPOWER REQUIREMENTS					
RPM	GPM	1000 PSI	1500 PSI	2000 PSI	2465 PSI
750	5.6	3.8	5.7	7.6	9.4
900	6.7	4.6	6.9	9.1	11.3
1010	7.5	5.2	7.7	10.2	12.7
1120	8.3	5.7	8.6	11.4	14.1
1240	9.2	6.3	9.5	12.6	15.6
1450	10.7	7.4	11.1	14.7	18.2

SPECIAL NOTE:
The theoretical gallons per revolution (gal/rev) is 0.0074. To find specific outputs at various RPM, use the formula: $GPM = 0.0074 \times RPM$

HORSEPOWER RATINGS:

The rating shown are the power requirements for the pump. Gas engine power outputs must be approximately twice the pump power requirements shown above.

We recommend a 1.15 service factor be specified when selecting an electric motor as the power source. To compute specific pump horsepower requirements, use the following formula:

$$HP = (GPM \times PSI) / 1450$$

Repair Instructions P420 / P420-0011 / P420-0021 / P422 / P423 and P425

Note: Always take time to lubricate all metal and nonmetal parts with a light film of oil before reassembly. This step will ensure proper fit, at the same time protecting the pump nonmetal parts (i.e., the elastomers) from cutting and scoring.

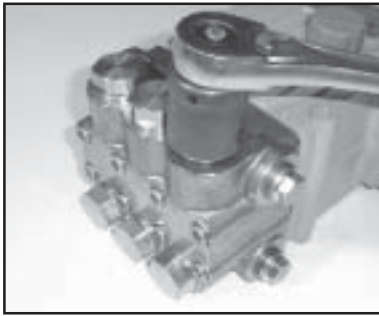

1) With a socket wrench, remove the three discharge valve plugs and three inlet valve plugs (32). Inspect the o-ring (33) for wear and replace if damaged.

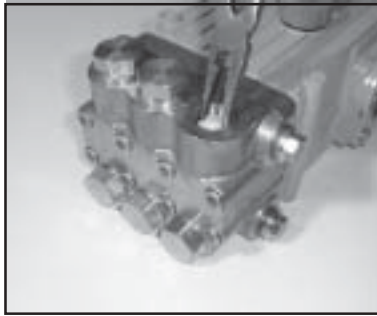

2) Using needle nose pliers, remove the inlet and discharge valve assemblies (27A). Note: It may become necessary to remove the valve seat (27) from the valve casing using a slidehammer.



3) By inserting a small screw driver between the valve seat (27) and the valve spring retainer (30), the valve assembly can be separated.



4) Remove the o-ring (31). Inspect all parts for wear and replace as necessary. Apply one drop of loctite 243 to the valve plugs (32) and tighten to 107 ft.-lbs. (145 NM).



5) Use a 8mm allen wrench to remove the 8 socket head cap screws (34). Carefully slide the valve casing (26) out over the plungers.

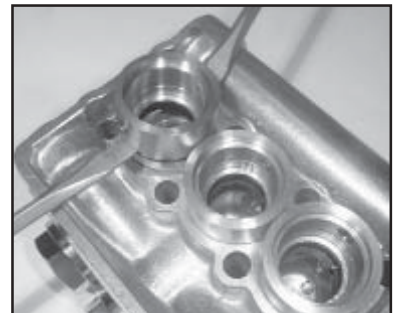

6) Remove seal adaptors (20) and weep return rings (25) from the valve casing.



7) Remove the pressure rings (24) and v-sleeves (23 - Note: P422 & P423 pumps have a support ring) from the valve casing (26).



8) Remove the weep grooved seal (23 or 23B) together with pressure ring (24 - P420 and P425 only) out of the seal adaptor (20). Check O-rings (21).

IMPORTANT! The grooved seal (23) on the high-pressure side is to be fitted carefully into the valve casing (26) using a screwdriver. Under no circumstances must the seal surface in the valve casing or the seal lip be damaged.

Repair Instructions P420 / P420-0011 / P420-0021 / P422 / P423 and P425

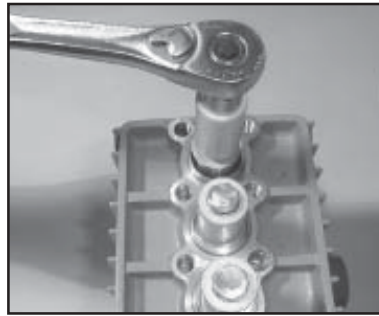
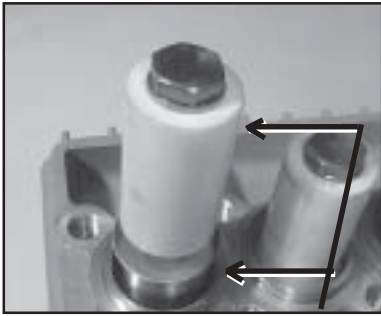

IMPORTANT!

Plunger surfaces are not to be damaged. If there are lime deposits in the pump, care must be taken that the drip-return bore in parts (25) and (26) ensure trouble-free drip-return.

- 9) Check surfaces of plunger (16). Damaged surfaces cause accelerated seal wear. Deposits of all kinds must be removed from the plungers.
- 10) If the plunger pipe (16B), is damaged or worn, remove tension screw (16D) and plunger pipe (16B). Check and clean plunger surface (16A) and check flinger (16H). Cover thread of tension screw (16D) with a thin film of Loctite and tighten carefully to 22 ft.-lbs. (30NM).
- 11) If oil leaks under the plunger (16), the oil seals (19) need to be replaced. Remove oil plug (5) and drain oil. With the valve casing (26) and seal case (20) removed (ref. instructions #5 & 6), and plunger disassembled (ref. #10), carefully pry out the oil seal with a flat screwdriver and replace it with a new one. Make sure that the oil seal groove faces inward towards the oil.
- 12) After installation of high pressure seals (23), place seal case (20) with weep seals & pressure ring installed, weep return ring (25) and high pressure weep return ring (24) over plungers. Slide valve casing over plungers and seat firmly. Replace the 8 socket head cap screws (34) and tighten to 30 ft.-lbs.(40 NM) in a crossing pattern (as shown at right).

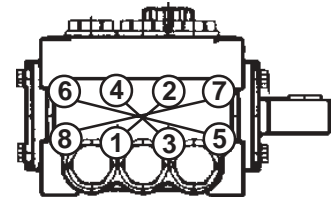

NOTE: Be careful not to score the crankcase guides where the oil seal sits and where the plunger base (16A) moves through the crankcase (1).

Torque Specifications

P420 / P420-0011 / P420-0021 / P422 / P423 and P425

<u>Position</u>	<u>Item#</u>	<u>Description</u>	<u>U.S</u>	<u>Metric</u>
15A	05349	Screw with Washer	97 in.-lbs.	11 NM
16D	08399	Tensioning Screw	22 ft.-lbs.	30 NM
32	08373	Plug	107 ft.-lbs.	145 NM
34	08396	Cap Screw	30 ft.-lbs.	40 NM

Contact Giant Industries for service school information. Phone: (419) 531-4600

PUMP SYSTEM MALFUNCTION

MALFUNCTION	CAUSE	REMEDY
The Pressure and/ or the Delivery Drops	Worn packing seals Broken valve spring Belt slippage Worn or Damaged nozzle Fouled discharge valve Fouled inlet strainer Worn or Damaged hose Worn or Plugged relief valve on pump Cavitation pump for restrictions Unloader	Replace packing seals Replace spring Tighten or Replace belt Replace nozzle Clean valve assembly Clean strainer Repair/Replace hose Clean, Reset, and Replace worn parts Check suction lines on inlet of Check for proper operation
Water in crankcase	High humidity Worn seals	Reduce oil change interval Replace seals
Noisy Operation	Worn bearings Cavitation	Replace bearings, Refill crankcase oil with recommended lubricant Check inlet lines for restrictions and/or proper sizing
Rough/Pulsating Operation with Pressure Drop	Worn packing Inlet restriction Accumulator pressure Unloader Cavitation	Replace packing Check system for stoppage, air leaks, correctly sized inlet plumbing to pump Recharge/Replace accumulator Check for proper operation Check inlet lines for restrictions and/or proper size
Pump Pressure as Rated, Pressure Drop at Gun	Restricted discharge plumbing	Re-size discharge plumbing to Flow Rate of Pump
Excessive Leakage	Worn plungers Worn packing/seals Excessive vacuum Cracked plungers Inlet pressure too high	Replace plungers Adjust or Replace packing seals Reduce suction vacuum Replace plungers Reduce inlet pressure
High Crankcase Temperature	Wrong Grade of oil Improper amount of oil in crankcase	Giant oil is recommended Adjust oil level to proper amount

Preventative Maintenance Check-List & Recommended Spare Parts List

Check	Daily	Weekly	50hrs	Every 500 hrs	Every 1500 hrs	Every 3000 hrs
Oil Level/Quality	X					
Oil Leaks	X					
Water Leaks	X					
Belts, Pulley		X				
Plumbing		X				
Recommended Spare Parts						
Oil Change (27 fl. oz.) p/n 1154			X	X		
Seal Spare Parts (1 kit/pump) (See page 7 for kit list)					X	
Oil Seal Kit (1 kit/pump) (See page 7 for kit list)					X	
Valve Spare Parts (1 kit/pump) (See page 7 for kit list)						X

Dimensions - P420/P420-0011/P420-0021/P422/P423 and P425 - Inches (mm)

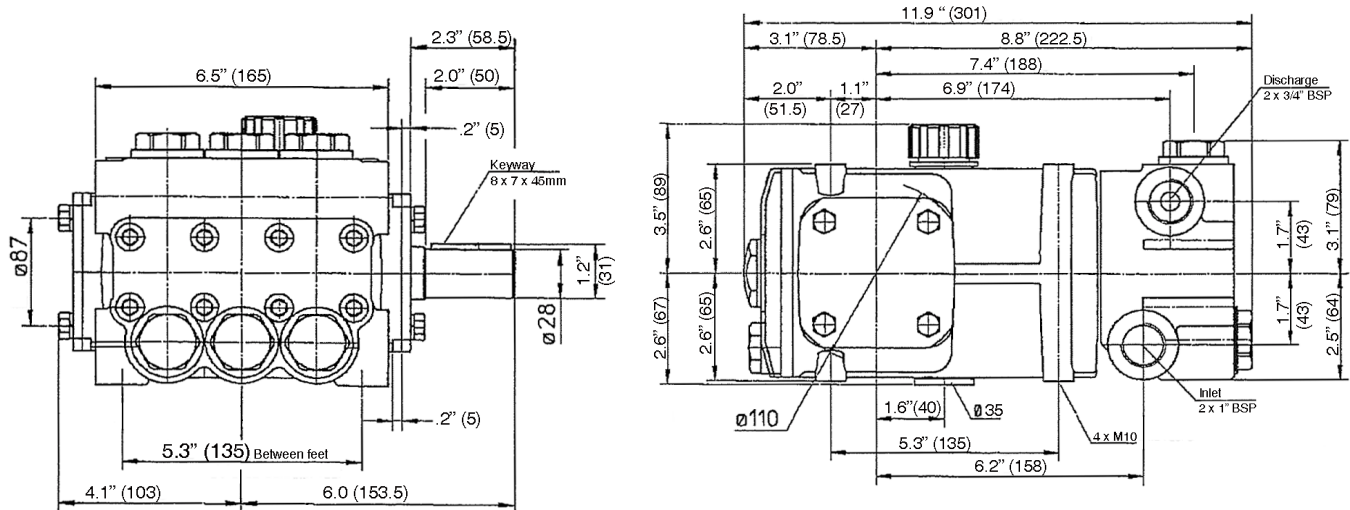

GIANT INDUSTRIES LIMITED WARRANTY

Giant Industries, Inc. pumps and accessories are warranted by the manufacturer to be free from defects in workmanship and material as follows:

1. For portable pressure washers and self-service car wash applications, the discharge manifolds will never fail, period. If they ever fail, we will replace them free of charge. Our other pump parts, used in portable pressure washers and in car wash applications, are warranted for five years from the date of shipment for all pumps used in NON-SALINE, clean water applications.
2. One (1) year from the date of shipment for all other Giant industrial and consumer pumps.
3. Six (6) months from the date of shipment for all rebuilt pumps.
4. Ninety (90) days from the date of shipment for all Giant accessories.

This warranty is limited to repair or replacement of pumps and accessories of which the manufacturer's evaluation shows were defective at the time of shipment by the manufacturer. The following items are NOT covered or will void the warranty:

1. Defects caused by negligence or fault of the buyer or third party.
2. Normal wear and tear to standard wear parts.
3. Use of repair parts other than those manufactured or authorized by Giant.
4. Improper use of the product as a component part.
5. Changes or modifications made by the customer or third party.
6. The operation of pumps and or accessories exceeding the specifications set forth in the Operations Manuals provided by Giant Industries, Inc.

Liability under this warranty is on all non-wear parts and limited to the replacement or repair of those products returned freight prepaid to Giant Industries which are deemed to be defective due to workmanship or failure of material. A Returned Goods Authorization (R.G.A.) number and completed warranty evaluation form is required prior to the return to Giant Industries of all products under warranty consideration. Call (419)-531-4600 or fax (419)-531-6836 to obtain an R.G.A. number.

Repair or replacement of defective products as provided is the sole and exclusive remedy provided hereunder and the MANUFACTURER SHALL NOT BE LIABLE FOR FURTHER LOSS, DAMAGES, OR EXPENSES, INCLUDING INCIDENTAL AND CONSEQUENTIAL DAMAGES DIRECTLY OR INDIRECTLY ARISING FROM THE SALE OR USE OF THIS PRODUCT.

THE LIMITED WARRANTY SET FORTH HEREIN IS IN LIEU OF ALL OTHER WARRANTIES OR REPRESENTATION, EXPRESS OR IMPLIED, INCLUDING WITHOUT LIMITATION ANY WARRANTIES OR MERCHANTABILITY OR FITNESS FOR A PARTICULAR PURPOSE AND ALL SUCH WARRANTIES ARE HEREBY DISCLAIMED AND EXCLUDED BY THE MANUFACTURER.



GIANT INDUSTRIES, INC., 900 N. Westwood Ave., P.O. Box 3187, Toledo, Ohio 43607
 PHONE (419) 531-4600, FAX (419) 531-6836, www.giantpumps.com
 © Copyright 2009 Giant Industries, Inc.