

Models LP350, LP400, LP450

Triplex Ceramic
Plunger Pump
Operating Instructions/
Repair and Service
Manual

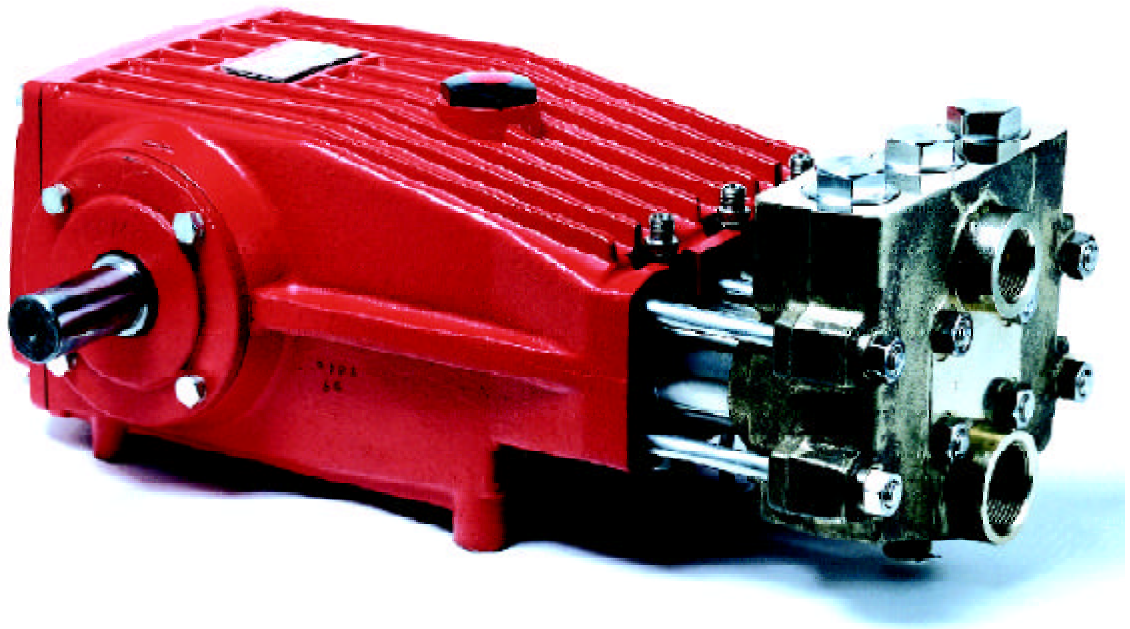

Contents:

Installation Instructions:	page 2
Pump Specifications:	pages 3-5
Exploded View:	page 6
Parts List/Kits/Torque Specs:	page 7
Trouble Shooting Chart:	page 8
Spare Parts List:	page 8
Repair Instructions:	page 9-11
Dimensions:	back page
Warranty Information:	back page

Updated 2/02

INSTALLATION INSTRUCTIONS

Installation of the Giant Industries, Inc., pump is not a complicated procedure, but there are some basic steps common to all pumps. The following information is to be considered as a general outline for installation. If you have unique requirements, please contact Giant Industries, Inc. or your local distributor for assistance.

1. The pump should be installed flat on a base to a maximum of a 15 degree angle of inclination to ensure optimum lubrication.
2. The inlet to the pump should be sized for the flow rate of the pump with no unnecessary restrictions that can cause cavitation. Teflon tape should be used to seal all joints. If pumps are to be operated at temperatures in excess of 140° F, it is important to insure a positive head to the pump to prevent cavitation.
3. The discharge plumbing from the pump should be properly sized to the flow rate to prevent line pressure loss to the work area. It is essential to provide a safety bypass valve between the pump and the work area to protect the pump from pressure spikes in the event of a blockage or the use of a shut-off gun.

4. Use of a dampener is necessary to minimize pulsation at drive elements, plumbing, connections, and other system areas. The use of a dampener with Giant Industries, Inc. pumps is optional, although recommended by Giant Industries, Inc. to further reduce system pulsation. Dampeners can also reduce the severity of pressure spikes that occur in systems using a shut-off gun. A dampener must be positioned downstream from the unloader.

5. Crankshaft rotation on Giant Industries, Inc. pumps should be made in the direction designated by the arrows on the pump crankcase. Reverse rotation may be safely achieved by following a few guidelines available upon request from Giant Industries, Inc. Required horsepower for system operation can be obtained from the charts on pages 3-5.

6. Before beginning operation of your pumping system, remember: Check that the crankcase and seal areas have been properly lubricated per recommended schedules. Do not run the pump dry for extended periods of time. Cavitation will result in severe damage. Always remember to check that all plumbing valves are open and that pumped media can flow freely to the inlet of the pump.

Finally, remember that high pressure operation in a pump system has many advantages. But, if it is used carelessly and without regard to its potential hazard, it can cause serious injury.

IMPORTANT OPERATING CONDITIONS

Failure to comply with any of these conditions invalidates the warranty.

1. Prior to initial operation, add oil to the crankcase so that oil level is between the two lines on the oil dipstick. **DO NOT OVERFILL.**

Use SAE 90 Industrial gear oil.

Crankcase oil should be changed after the first 50 hours of operation, then at regular intervals of 500 hours or less depending on operating conditions.

2. Pump operation must not exceed rated pressure, volume, or RPM. A pressure relief device must be installed in the discharge of the system.

3. Acids, alkalines, or abrasive fluids cannot be pumped unless approval in writing is obtained before operation from Giant Industries, Inc.

4. Run the pump dry approximately 10 seconds to drain the water before exposure to freezing temperatures.

Specifications

Model LP350

Volume	Up to 22.6 GPM
Discharge Pressure	2350 PSI
Inlet Pressure	Up to 90 PSI
Maximum Crankshaft Speed	Up to 1000 RPM
Plunger Diameter	30mm
Stroke	42mm
Crankcase Oil Capacity	100 fl.oz.
Temperature of Pumped Fluids	140 °F @1000 RPM
.....	160 °F Up to 500 RPM
Inlet Port	1-1/4" BSP+
Discharge Port	1" BSP++
Shaft Mounting	Either side
Shaft Rotation	Top of pulley towards manifold
Weight	105 lbs.
Crankshaft Diameter	35mm

+

++

PULLEY INFORMATION

Pulley selection and pump speed are based on a 1725 RPM motor and "B" section belts. When selecting desired GPM, allow for a ±5% tolerance on pumps output due to variations in pulleys, belts and motors among manufacturers.

1. Select GPM required, then select appropriate motor and pump pulley from the same line.
2. The desired pressure is achieved by selecting the correct nozzle size that corresponds with the pump GPM.

HORSEPOWER INFORMATION

Horsepower ratings shown are the power requirements for the pump. Gas engine power outputs must be approximately twice the pump power requirements shown above.

We recommend that a 1.1 service factor be specified when selecting an electric motor as the power source. To compute specific pump horsepower requirements, use the following formula:

$$HP = (GPM \times PSI) / 1440$$

LP350 PULLEY SELECTION AND HORSEPOWER REQUIREMENTS							
PUMP PULLEY	MOTOR PULLEY	RPM	GPM	500 PSI	1000 PSI	2000 PSI	2300 PSI
12.75"	3.95"	500	11.3	3.9	7.8	15.7	18.0
12.75"	4.95"	640	14.5	5.0	10.0	20.1	23.1
12.75"	5.75"	750	16.9	5.9	11.8	23.5	27.1
12.75"	6.15"	805	18.2	6.3	12.6	25.3	29.0
12.75"	6.55"	865	19.5	6.8	13.6	27.1	31.2
12.75"	6.95"	940	21.2	7.4	14.7	29.5	33.9
12.75"	7.50"	1000	22.6	7.8	15.7	31.4	36.1

Specifications

Model LP400

Volume	Up to 15.1 GPM
Discharge Pressure	3600 PSI
Inlet Pressure	Up to 90 PSI
Maximum Crankshaft Speed	Up to 1000 RPM
Plunger Diameter	24mm
Stroke	42mm
Crankcase Oil Capacity	100 fl.oz.
Temperature of Pumped Fluids	140 °F @1000 RPM
.....	160 °F Up to 500 RPM
Inlet Port	1-1/4" BSP
Discharge Port	1" BSP
Shaft Mounting	Either side
Shaft Rotation	Top of pulley towards manifold
Weight	105 lbs.
Crankshaft Diameter	35mm

PULLEY INFORMATION

Pulley selection and pump speed are based on a 1725 RPM motor and "B" section belts. When selecting desired GPM, allow for a ±5% tolerance on pumps output due to variations in pulleys, belts and motors among manufacturers.

1. Select GPM required, then select appropriate motor and pump pulley from the same line.
2. The desired pressure is achieved by selecting the correct nozzle size that corresponds with the pump GPM.

HORSEPOWER INFORMATION

Horsepower ratings shown are the power requirements for the pump. Gas engine power outputs must be approximately twice the pump power requirements shown above.

We recommend that a 1.1 service factor be specified when selecting an electric motor as the power source. To compute specific pump horsepower requirements, use the following formula:

$$HP = (GPM \times PSI) / 1440$$

LP400 PULLEY SELECTION AND HORSEPOWER REQUIREMENTS							
PUMP PULLEY	MOTOR PULLEY	RPM	GPM	2000 PS	2500 PSI	3000 PSI	3600 PSI
12.75"	3.95"	500	7.5	10.5	13.1	15.7	18.8
12.75"	4.95"	640	9.6	13.4	16.7	20.1	24.1
12.75"	5.75"	750	11.3	15.7	19.6	23.5	28.2
12.75"	6.15"	805	12.1	16.8	21.0	25.3	30.3
12.75"	6.55"	865	13.0	18.1	22.6	27.1	32.6
12.75"	6.95"	940	14.2	19.7	24.6	29.5	35.4
12.75"	7.50"	1000	15.1	20.9	26.1	31.4	37.6

Specifications

Model LP450

Volume	Up to 19.7 GPM
Discharge Pressure	2600 PSI
Inlet Pressure	Up to 90 PSI
Maximum Crankshaft Speed	Up to 1000 RPM
Plunger Diameter	28mm
Stroke	42mm
Crankcase Oil Capacity	100 fl.oz.
Temperature of Pumped Fluids	140 °F @1000 RPM
.....	160 °F Up to 500 RPM
Inlet Port	1-1/4" BSP
Discharge Port	1" BSP
Shaft Mounting	Either side
Shaft Rotation	Top of pulley towards manifold
Weight	105 lbs.
Crankshaft Diameter	35mm

PULLEY INFORMATION

Pulley selection and pump speed are based on a 1725 RPM motor and "B" section belts. When selecting desired GPM, allow for a ±5% tolerance on pumps output due to variations in pulleys, belts and motors among manufacturers.

1. Select GPM required, then select appropriate motor and pump pulley from the same line.
2. The desired pressure is achieved by selecting the correct nozzle size that corresponds with the pump GPM.

HORSEPOWER INFORMATION

Horsepower ratings shown are the power requirements for the pump. Gas engine power outputs must be approximately twice the pump power requirements shown above.

We recommend that a 1.1 service factor be specified when selecting an electric motor as the power source. To compute specific pump horsepower requirements, use the following formula:

$$HP = (GPM \times PSI) / 1440$$

LP450 PULLEY SELECTION AND HORSEPOWER REQUIREMENTS							
PUMP PULLEY	MOTOR PULLEY	RPM	GPM	1000 PS	1500 PSI	2000 PSI	2600 PSI
12.75"	3.95"	500	9.8	6.8	10.3	13.7	17.8
12.75"	4.95"	640	12.6	8.7	13.1	17.5	22.7
12.75"	5.75"	750	14.8	10.3	15.4	20.5	26.7
12.75"	6.15"	805	15.8	11.0	16.5	22.0	28.6
12.75"	6.55"	865	17.0	11.8	17.7	23.6	30.7
12.75"	6.95"	940	18.5	12.8	19.3	25.7	33.4
12.75"	7.50"	1000	19.7	13.7	20.5	27.3	35.5

LP350, LP400, LP450 - EXPLODED VIEW

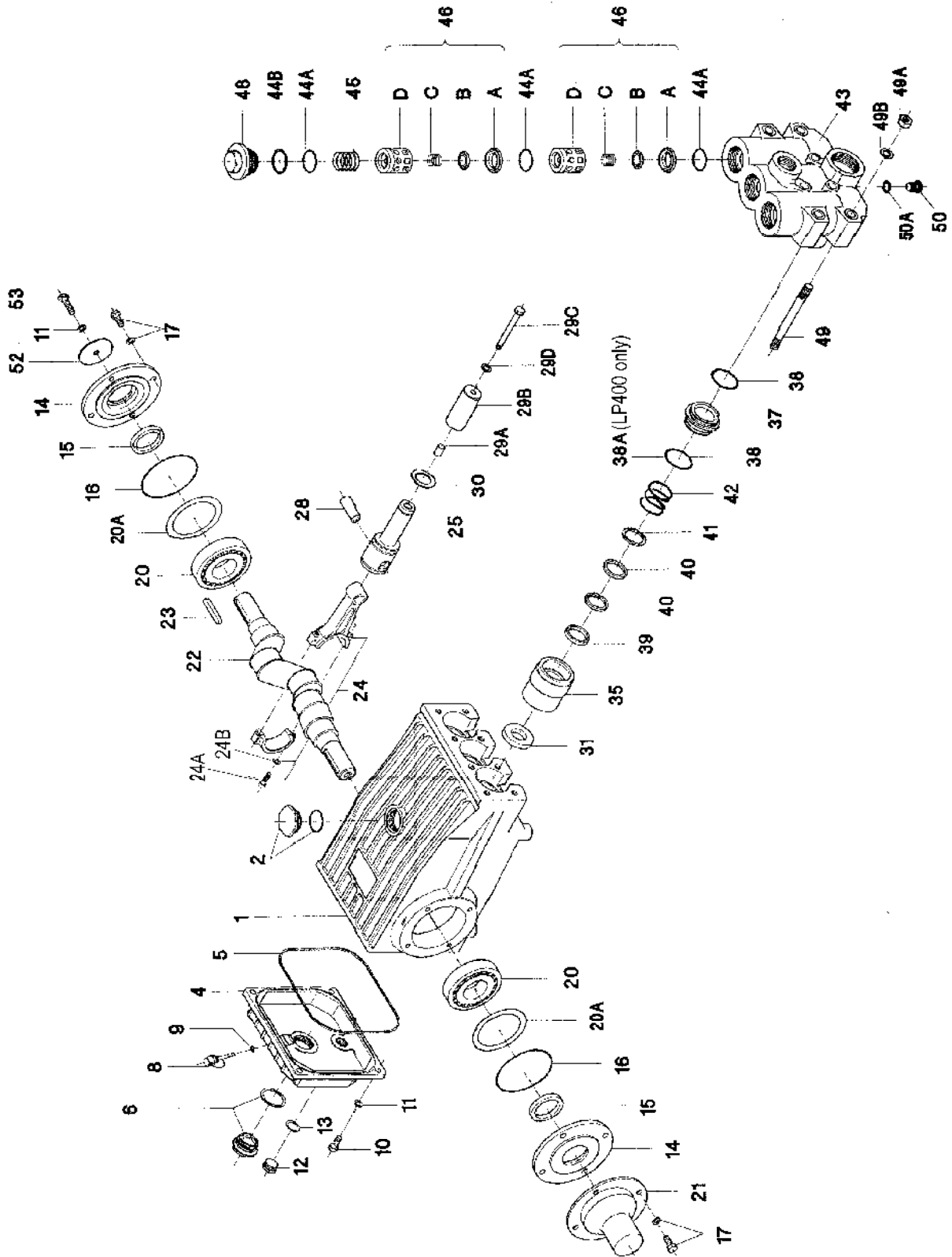

LP350, LP400 & LP450 PARTS LIST

ITEM #	PART #	DESCRIPTION	QTY	ITEM #	PART #	DESCRIPTION	QTY
1	07759	Crankcase	1	35	06650	Seal Sleeve(LP350,LP450)	3
2	13000	Oil filler plug assy.	1	37	13393	Seal Case(LP400)	3
4	06085	Crankcase Cover	1	37	06651	SealCase(LP350/LP450)	3
5	07104	O-ring, Crankcase cover	1	38	07140	O-Ring(LP400)	3
6	07186	Oil Sightglass with Gasket	1	38	07700	O-Ring(LP350/LP450)	6
8	06086	Oil Dipstick	1	38A	12055	O-Ring(LP400 Only)	3
9	01009	O-Ring, Dipstick	1	39	07271	Pressure Ring(LP350)	3
10	01010	Cylinder Screw	4	39	13016	Pressure Ring(LP400)	3
11	01011	Spring Ring	5	39	13013	Pressure Ring(LP450)	3
12	07109	Plug	1	40	13016	V-Sleeve(LP350)	6
13	07182	Gasket	1	40	06083	V-Sleeve(LP400)	6
14	07111	Bearing Cover	2	40	13015	V-Sleeve(LP450)	6
15	07112	Radial Shaft Seal	2	41	07273	Support Ring(LP350)	3
16	07113	O-Ring	2	41	13367	Support Ring(LP400)	3
17	07114	Hexagon Screw	8	41	06652	Support Ring(LP450)	3
20	07116	Taper Roller Bearing	2	42	07338	Pressure Spring(LP400)	3
20A	07117	Fitting Disc	1-3	42	14084	Pressure Spring(LP350/LP450)	3
20B	13001	Fitting Disc (May not be present)	1-3	43	13018	Valve Casing	1
21	07118	Shaft Protector	1	44A	07150	O-Ring	9
22	13242	Crankshaft	1	44B	06266	Support Ring	3
23	13243	Woodruff Key	1	45	06078	Compression Spring	3
24	13340	Connecting Rod Assy.	3	46	07060	Valve Assy.	6
24A	13277	Inner Hexagon Screw	6	46A	07064	Valve Seat	6
24B	13278	Spring Washer	6	46B	07063	Valve Plate	6
25	13244	Crosshead / Plunger Assy.	3	46C	07062	Valve Spring	6
28	13232	Crosshead Pin	3	46D	07066	Spacer Pipe	6
29A	07256	Centering sleeve	3	48	07156	Plug	3
29B	13046	Plunger Pipe(LP400)	3	49	07754	Stud bolt	8
29B	13005	Plunger Pipe(LP450)	3	49A	07158	Hexagon Nut	8
29B	07261	Plunger Pipe(LP350)	3	49B	07159	Disc	8
29C	13007	Tensioning Screw	3	50	07423	Plug, 1/4" BSP	1
29D	07258	Copper Ring	3	50A	07161	Copper Ring	1
30	07779	O-Ring	3	52	13020	Disc for Crankshaft	1
31	07133	Oil Seal	3	53	06607	Hexagon Screw	1
35	13392	Seal Sleeve(LP400)	3				

LP350, LP400 & LP450 KITS

Pumps Manufactured Prior to 2/97			
Packing Kit, LP350		#09233	
(prior to 2/97)			
<u>Item</u>	<u>Part #</u>	<u>Description</u>	<u>Qty</u>
38	7140	O-ring	3
38A	13012	O-ring	3
40	13016	V-sleeve	6
41	7150	O-ring	3
Packing Kit, LP400		#09309	
(prior to 2/97)			
<u>Item</u>	<u>Part #</u>	<u>Description</u>	<u>Qty</u>
38	07140	O-ring	3
38A	13012	O-ring	3
40	13049	V-sleeve	3
40A	13050	Support-ring	3
Packing Kit LP450		#09234	
(prior to 2/97)			
<u>Item</u>	<u>Part #</u>	<u>Description</u>	<u>Qty</u>
38	07140	O-ring	3
38A	12055	O-ring	3
40	13015	V-Sleeve	6
41	06652	O-ring	3

Pumps Manufactured After 2/97			
Packing Kit, LP350		#09546	
(after 2/97)			
<u>Item</u>	<u>Part #</u>	<u>Description</u>	<u>Qty</u>
38	07700	O-Ring	6
40	13016	V-Sleeve	6
Packing Kit LP400		#09548	
(after to 2/97)			
<u>Item</u>	<u>Part #</u>	<u>Description</u>	<u>Qty</u>
38	07140	O-ring	3
38A	12055	O-ring	3
40	06083	V-sleeve	6
Packing Kit LP450		#09549	
(after to 2/97)			
<u>Item</u>	<u>Part #</u>	<u>Description</u>	<u>Qty</u>
38	07700	O-ring	6
40	13015	V-Sleeve	6

Valve Kit #09196

Item	Part #	Description	Qty
44A	07150	O-Ring	6
44B	06266	Support Ring	3
46A	7064	Valve seat	1
46B	7063	Valve plate	1
46C	7062	Valve spring	1

TORQUE SPECIFICATIONS

Position	Description	Torque Amount
24	Connecting Rod	264 in.-lbs.
29C	Tensioning Screw	33 ft.-lbs.
49A	Hexagon Nut	59 ft.-lbs.

PUMP SYSTEM MALFUNCTION

<u>MALFUNCTION</u>	<u>CAUSE</u>	<u>REMEDY</u>
The Pressure and/or the Delivery Drops	Worn packing seals Broken valve spring Belt slippage Worn or Damaged nozzle Fouled discharge valve Fouled inlet strainer Worn or Damaged hose Worn or Plugged relief valve on pump Cavitation pump for restrictions Unloader	Replace packing seals Replace spring Tighten or Replace belt Replace nozzle Clean valve assembly Clean strainer Repair/Replace hose Clean, Reset, and Replace worn parts Check suction lines on inlet of Check for proper operation
Water in crankcase	High humidity Worn seals	Reduce oil change interval Replace seals
Noisy Operation	Worn bearings oil with Cavitation	Replace bearings, Refill crankcase recommended lubricant Check inlet lines for restrictions and/or proper sizing
Rough/Pulsating Operation with Pressure Drop	Worn packing Inlet restriction Accumulator pressure Unloader Cavitation	Replace packing Check system for stoppage, air leaks, correctly sized inlet plumbing to pump Recharge/Replace accumulator Check for proper operation Check inlet lines for restrictions and/or proper size
Pump Pressure as gun Rated, Pressure	Restricted discharge plumbing	Re-size discharge plumbing to Drop at flow rate of pump
Excessive Leakage	Worn plungers Worn packing/seals Excessive vacuum Cracked plungers Inlet pressure too high	Replace plungers Adjust or Replace packing seals Reduce suction vacuum Replace plungers Reduce inlet pressure
High Crankcase Temperature	Wrong Grade of oil Improper amount of oil in crankcase	Giant oil is recommended Adjust oil level to proper amount

Preventative Maintenance Check-List & Recommended Spare Parts List						
Check	Daily	Weekly	50hrs	Every 500 hrs	Every 1500 hrs	Every 3000 hrs
Oil Level/Quality	X					
Oil Leaks	X					
Water Leaks	X					
Belts, Pulley		X				
Plumbing		X				
Recommended Spare Parts						
Oil Change (1 Gallon) p/n 1154			X	X		
Seal Spare Parts (1 kit/pump) (See page 7 for kit list)					X	
Oil Seal Kit (1 kit/pump) (See page 7 for kit list)					X	
Valve Spare Parts (1 kit/pump) (See page 7 for kit list)						X

REPAIR INSTRUCTION - LP350, LP400, LP450

TO CHECK VALVES

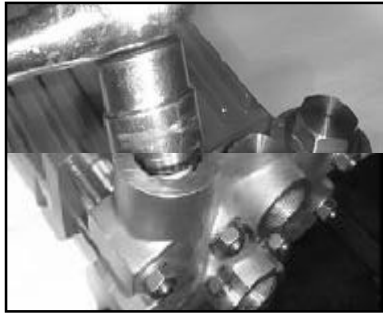

1) With a 30mm wrench remove the three (3) tension plugs (48) from top of valve casing (43).

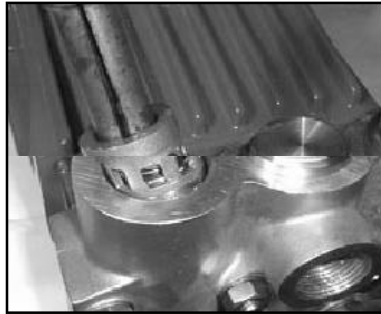

2) Remove discharge and inlet valve assemblies (46) by pulling them upwards out of the valve casing (43). It may be necessary to use a slide hammer tool.



3) With the valve assembly (46) pointed down, place a dowel rod through the top of spacer pipe (46D). Hold assembly in hand and tap end of dowel sharply with mallet until assembly breaks free.

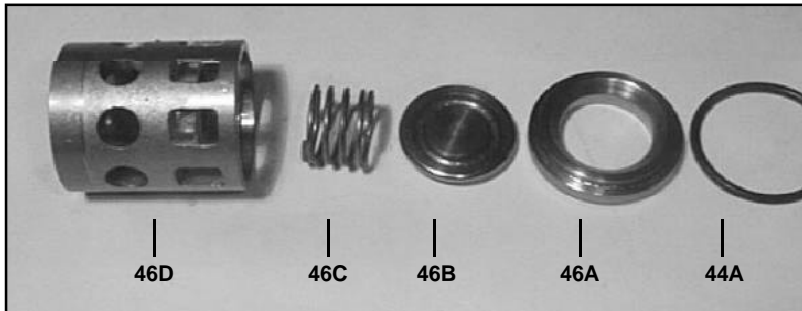

4) Inspect valve seats (46A) and valve plates (46B) for damage and replace if needed. Check valve casing (43) surfaces for damage. Replace o-rings (44A) and reinstall valve assemblies (46) into valve casing. (Lubricate o-rings before installation.)



5) Replace tension plugs (48) and tighten them securely.

SEAL AND PLUNGER REPLACEMENT



6) Remove the eight (8) manifold nuts and washers (49A,B) using a 19mm wrench and pull off valve casing (43).



7) If needed, tap valve casing with a rubber mallet to remove it.

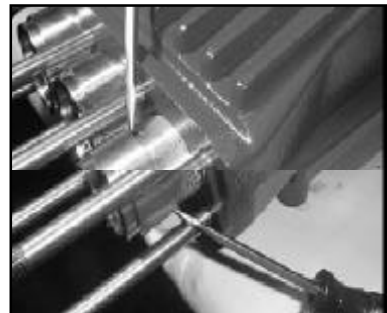

8) Using two flat screw drivers, pry seal sleeve (35) out of crankcase guides.

REPAIR INSTRUCTION - LP350, LP400, LP450



9) Remove seal case (37) from seal sleeve (35).



10) Check plunger surface (25 and 29B) for wear and pitting. If none is found, proceed to step twelve.



11) If plunger (29B) is worn, remove tension screw (29C) with a 17mm wrench. Clean tension screw with wire brush to remove any old locktite. Discard copper gasket (29D) and replace with new. Clean the front surface of plunger/ crosshead assembly (25). Install new plunger (29B) onto plunger/ crosshead assembly. Put some locktite on both surfaces of copper gasket and tension screw threads. Secure plunger in place with tension screw and gasket and tighten to 33 ft.-lbs.

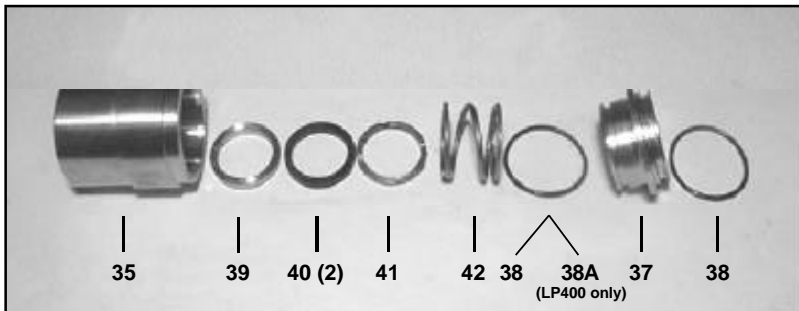

12) Remove v-sleeves (40) and support ring (41) for seal case (37) and replace with new elastomers. Lubricate parts before reinstalling into seal sleeve. Replace seal sleeve/seal case assembly (35/37) into the valve casing (43).

14) Replace nuts and washers (49A, B) and tighten to 59 ft.-lbs. in the pattern as shown to the right.

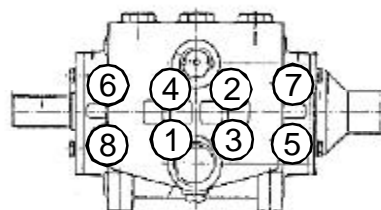

13) Place entire manifold assembly sleeve assembly over the studs (49) and push firmly until seated against the crankcase (1).

REPAIR INSTRUCTIONS - LP350, LP400, LP450

DISASSEMBLY OF CRANKCASE

- 1) Remove valve casing (43) and plunger pipe (29B), drain oil.
- 2) Screw off gear cover (4) and bearing cover (14).
- 3) Remove connecting rod screws (24) and push the front of connecting rod forward as far as possible. Remove back halves of connecting rods, note which position from which they came from.
- 4) Turning the crankshaft slightly, carefully hit on side of crankshaft (22) with a rubber mallet until crankshaft is loose.

CAUTION: Do not bend the connecting rod shafts. Check cranshaft and connecting rod surfaces, shaft seals and taper roller bearings.

REASSEMBLY

- 5) Using a soft tool, press in the outer bearing ring until the outer edge lines up with the outer edge of the bearing hole (1).
- 6) Remove the bearing cover (14) together with the shaft seal (15) and o-ring (16). Fit crankshaft through bearing hole on the opposite side.
- 7) Press in outer bearing (20) inwards with the bearing cover (14). Make sure that the crankshaft is in a vertical position and turn it slowly so that the taper rollers of the bearings touch the edge of outer bearing ring.
- 8) Adjust axial bearing clearance to at least .004" and maximum at .006" by placing fitting discs (20A and/or 20B) under the bearing cover (14).

CAUTION: After assembly has been completed, the crankshaft should turn easily and with very little clearance.

- 9) Bolt connecting rod halves together making sure they are replaced in the same position from which they came. Tighten connecting rod screws to 264 in.-lbs.

LP350, LP400 & LP450 DIMENSIONS (inches)

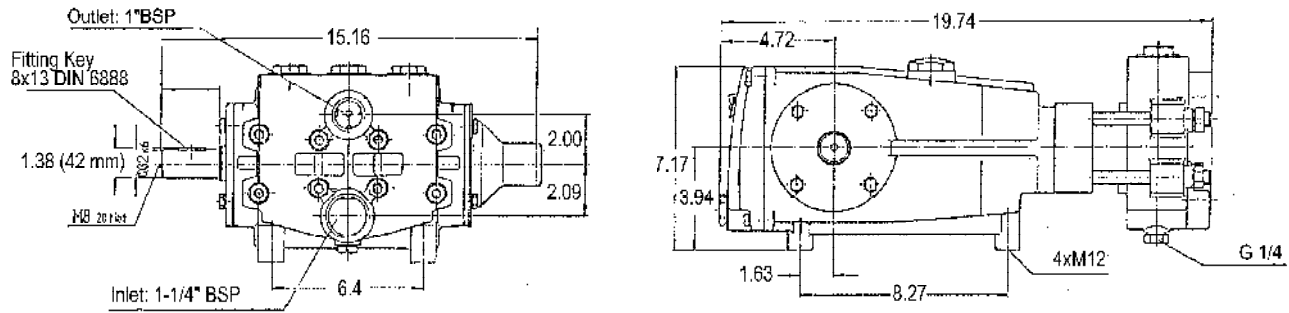

GIANT INDUSTRIES LIMITED WARRANTY

Giant Industries, Inc. pumps and accessories are warranted by the manufacturer to be free from defects in workmanship and material as follows:

1. For portable pressure washers and car wash applications, the discharge manifolds will never fail, period. If they ever fail, we will replace them free of charge. Our other pump parts, used in portable pressure washers and in car wash applications, are warranted for five years from the date of shipment for all pumps used in NON-SALINE, clean water applications.
2. One (1) year from the date of shipment for all other Giant industrial and consumer pumps.
3. Six (6) months from the date of shipment for all rebuilt pumps.
4. Ninety (90) days from the date of shipment for all Giant accessories.

This warranty is limited to repair or replacement of pumps and accessories of which the manufacturer's evaluation shows were defective at the time of shipment by the manufacturer. The following items are NOT covered or will void the warranty:

1. Defects caused by negligence or fault of the buyer or third party.
2. Normal wear and tear to standard wear parts.
3. Use of repair parts other than those manufactured or authorized by Giant.
4. Improper use of the product as a component part.
5. Changes or modifications made by the customer or third party.
6. The operation of pumps and or accessories exceeding the specifications set forth in the Operations Manuals provided by Giant Industries, Inc.

Liability under this warranty is on all non-wear parts and limited to the replacement or repair of those products returned freight prepaid to Giant Industries which are deemed to be defective due to workmanship or failure of material. A Returned Goods Authorization (R.G.A.) number and completed warranty evaluation form is required prior to the return to Giant Industries of all products under warranty consideration. Call (419)-531-4600 or fax (419)-531-6836 to obtain an R.G.A. number.

Repair or replacement of defective products as provided is the sole and exclusive remedy provided here under and the MANUFACTURER SHALL NOT BE LIABLE FOR FURTHER LOSS, DAMAGES, OR EXPENSES, INCLUDING INCIDENTAL AND CONSEQUENTIAL DAMAGES DIRECTLY OR INDIRECTLY ARISING FROM THE SALE OR USE OF THIS PRODUCT.

THE LIMITED WARRANTY SET FORTH HEREIN IS IN LIEU OF ALL OTHER WARRANTIES OR REPRESENTATION, EXPRESS OR IMPLIED, INCLUDING WITHOUT LIMITATION ANY WARRANTIES OR MERCHANTABILITY OR FITNESS FOR A PARTICULAR PURPOSE AND ALL SUCH WARRANTIES ARE HEREBY DISCLAIMED AND EXCLUDED BY THE MANUFACTURER.

