

Models

CLP121A/CLP121A-4000 - CO₂ pumps

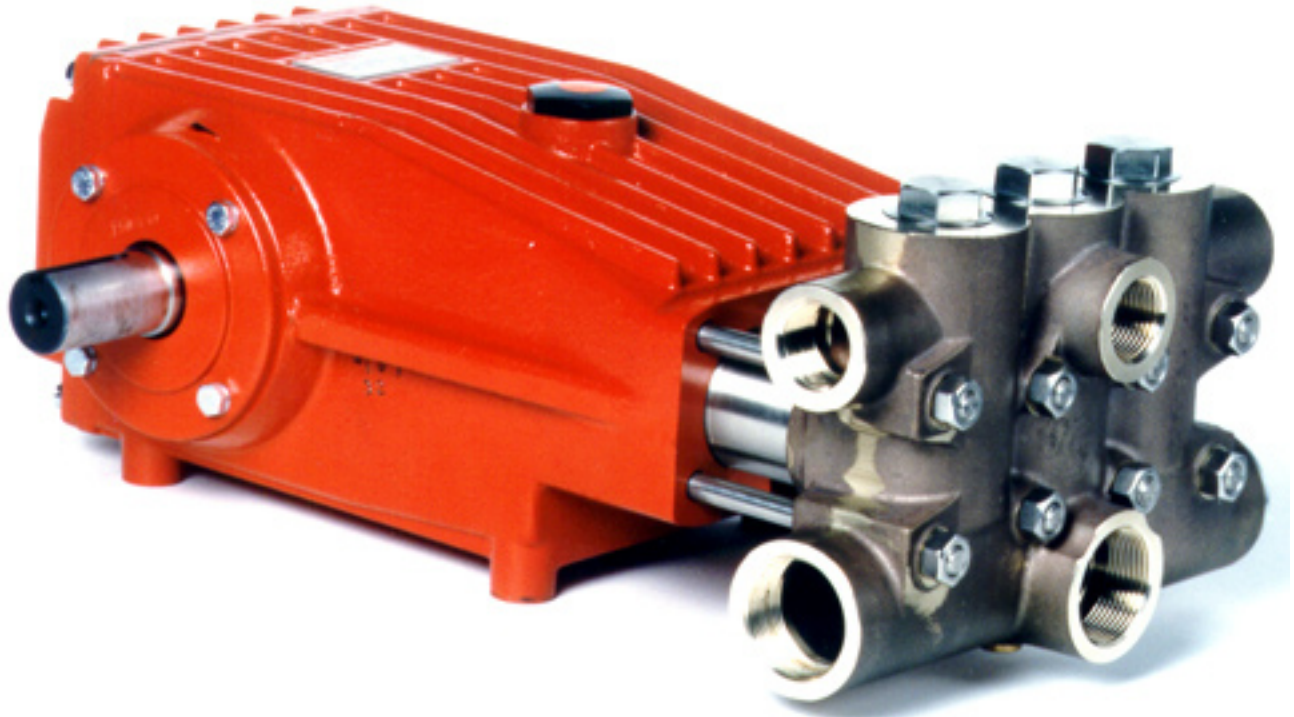

Contents:

Installation Instructions:	page 2
CLP121A Specifications:	page 3
Exploded View:	page 4
Parts List/Repair Kits:	page 5
Repair Instructions:	page 6-7
Torque Specifications:	page 7
Pump Mounting Selection Guide:	page 7
Dimensions:	page 8
Warranty Information:	back page

Installation Instructions

Installation of the Giant Industries, Inc., pump is not a complicated procedure, but there are some basic steps common to all pumps. The following information is to be considered as a general outline for installation. If you have unique requirements, please contact Giant Industries, Inc. or your local distributor for assistance.

1. The pump should be installed flat on a base to a maximum of a 15 degree angle of inclination to ensure optimum lubrication.
2. The inlet to the pump should be sized for the flow rate of the pump with no unnecessary restrictions that can cause cavitation. Teflon tape should be used to seal all joints. It is important to insure a positive head to the pump to prevent cavitation.
3. The discharge plumbing from the pump should be properly sized to the flow rate to prevent line pressure loss to the work area. It is essential to provide a safety bypass valve between the pump and the work area to protect the pump from pressure spikes in the event of a blockage or the use of a shut-off gun.

4. Use of a dampener is necessary to minimize pulsation at drive elements, plumbing, connections, and other system areas. The use of a dampener with Giant Industries, Inc. pumps is optional, although recommended by Giant Industries, Inc. to further reduce system pulsation. Dampeners can also reduce the severity of pressure spikes that occur in systems using a shut-off gun. A dampener must be positioned downstream from the unloader.

5. Crankshaft rotation on Giant Industries, Inc. pumps should be made in the direction designated by the arrows on the pump crankcase. Reverse rotation may be safely achieved by following a few guidelines available upon request from Giant Industries, Inc. Required horsepower for system operation can be obtained from the chart on page 3.

6. Before beginning operation of your pumping system, remember: Check that the crankcase and seal areas have been properly lubricated per recommended schedules. Do not run the pump dry for extended periods of time. Cavitation will result in severe damage. Always remember to check that all plumbing valves are open and that pumped media can flow freely to the inlet of the pump.

Finally, remember that high pressure operation in a pump system has many advantages. But, if it is used carelessly and without regard to its potential hazard, it can cause serious injury.

IMPORTANT OPERATING CONDITIONS

Failure to comply with any of these conditions invalidates the warranty.

1. Prior to initial operation, add oil to the crankcase so that oil level is between the two lines on the oil dipstick. **DO NOT OVERFILL.**

**Use synthetic motor oil (SAE 0W40).
Fill to 0.92 Gallons (3.5 liters)**

Crankcase oil should be changed after the first 50 hours of operation, then at regular intervals of 500 hours or less depending on operating conditions.

2. Pump operation must not exceed rated pressure, volume, or RPM. A pressure relief device must be installed in the discharge of the system.

3. Acids, alkalines, or abrasive fluids cannot be pumped unless approval in writing is obtained before operation from Giant Industries, Inc.

4. Run the pump dry approximately 10 seconds to drain the water before exposure to freezing temperatures.

Specifications

Model CLP121A/CLP121A-4000

	U.S	Metric
Volume	16.3 GPM	61.6 LPM
Discharge Pressure	1740 PSI	120 BAR
Inlet Pressure	580 PSI	40 BAR
Speed	Up to 500 RPM	
Plunger Diameter	1.42"	36mm
Stroke	1.65"	42mm
Crankcase Oil Capacity	118 fl.oz.....	3.5 L
Inlet Port	(3) x 1" BSP	
Discharge Port	(3) x 1-1/2" BSP	
Crankshaft Mounting	Either Side	
Shaft Rotation	Top of Pulley Towards Fluid End	
Weight	116 lbs.	52.6 kg
Crankshaft Diameter	1.38"	35mm
Manifold Material (CLP121A):.....	Bronze	
Manifold Material (CLP121A-4000)	303 Stainless Steel	

PULLEY INFORMATION

Pulley selection and pump speed are based on a 1725 RPM motor and "B" section belts. When selecting desired GPM, allow for a ±5% tolerance on pumps output due to variations in pulleys, belts and motors among manufacturers.

1. Select GPM required, then select appropriate motor and pump pulley from the same line.
2. The desired pressure is achieved by selecting the correct nozzle size that corresponds with the pump GPM.

HORSEPOWER INFORMATION

We recommend that a 1.15 service factor be specified when selecting an electric motor as the power source. To compute specific pump horsepower requirements, use the following formula:

$$HP = (GPM \times PSI) / 1450$$

CLP121A HORSEPOWER REQUIREMENTS					
RPM	GPM	500 PSI	1000 PSI	1500 PSI	1740 PSI
200	5.16	1.8	3.6	5.4	6.2
300	7.74	2.7	5.4	8.1	9.4
400	10.32	3.6	7.2	10.8	12.5
500	12.90	4.5	9.0	13.4	15.6

CLP121A/CLP121A-4000 Exploded View

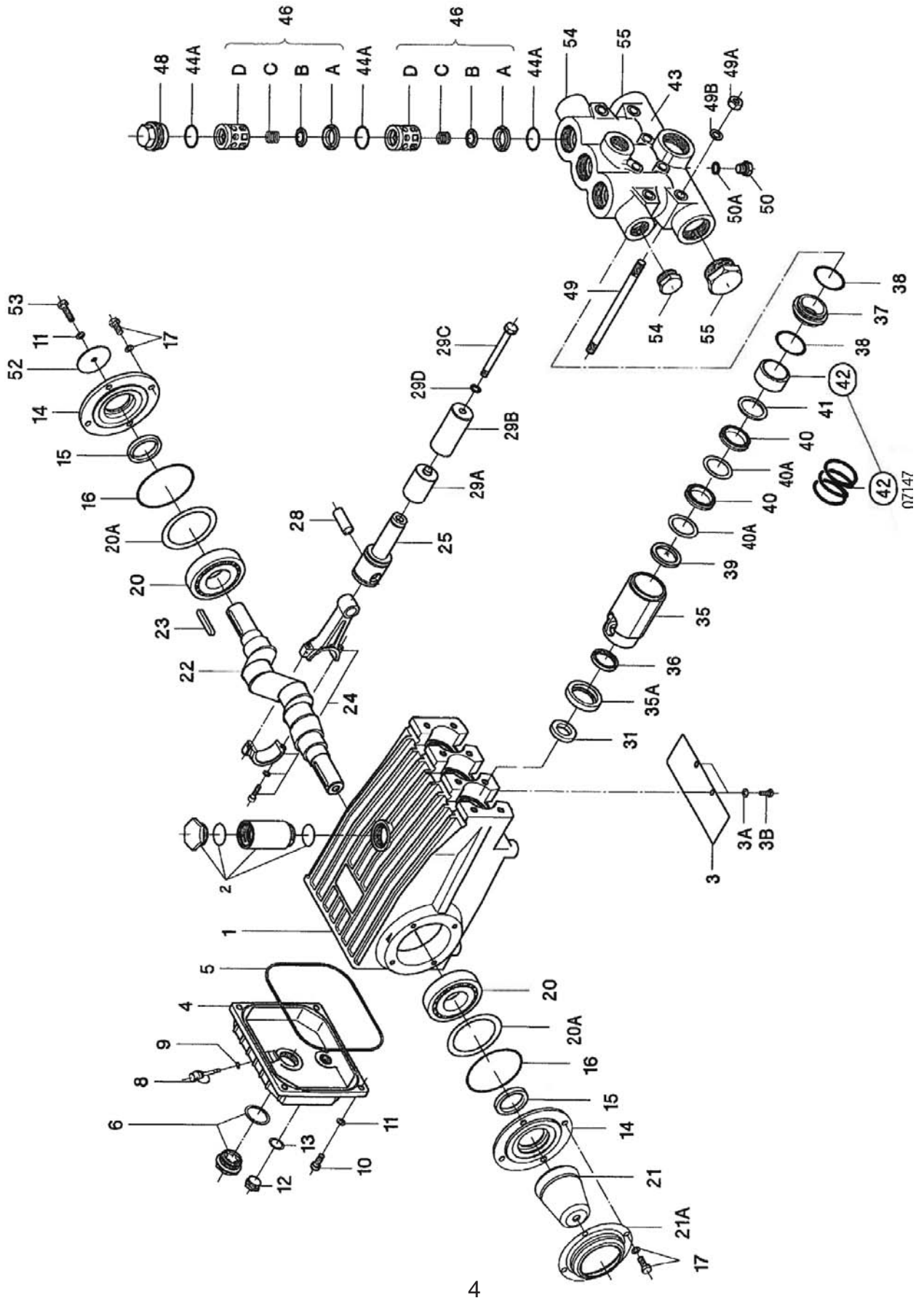

CLP121A/CLP121A-4000 Parts List

<u>Item</u>	<u>Part #</u>	<u>Description</u>	<u>Qty.</u>	<u>Item</u>	<u>Part #</u>	<u>Description</u>	<u>Qty.</u>
1	05198	Crankcase	1	29C	05201	Tension Screw	3
2	05199	Oil filler Plug Assy.	1	29D	07755	Copper Ring (CLP121A)	3
3	05940	Cover Plate	1	31	07133	Oil Seal	3
3A	7223-0100	Spring Ring	2	35	05203	Seal Sleeve (CLP121A)	3
3B	05051	Hexagon Screw	2	35	05203-0100	Seal Sleeve (CLP121A-4000)	3
4	06085	Crankcase Cover	1	35A	05204	Retainer (CLP121A)	3
5	07104	O-ring, Crankcase Cover	1	35A	05203-0100	Pressure Ring (CLP121A-4000)	3
6	05943	Oil Sight Glass Assembly	1	36	13291-0020	Grooved Seal	3
8	06086	Oil Dipstick Assy	1	37	07139	Seal Case	3
9	01009	O-Ring, Dipstick Assy.	1	38	07140-0003*	O-Ring	3
10	01010	Cylinder Screw (CLP121A)	4	39	05941	Pressure Ring	3
10	01010-0100	Cylinder Screw (CLP121A-4000)	5	40	06917	V-Sleeve	9
11	01011-0400	Spring Ring	5	40A	06916	V-Sleeve, Teflon	6
12	07109	Plug (CLP121A)	1	41	06918	Support Ring	3
12	07109-0400	Plug (CLP121A-4000)	1	42	05942	Spacer Pipe	3
13	07182	Gasket	1	43	13029	Valve Casing (CLP121A)	1
14	07111	Bearing Cover	2	43	13018-5200	Valve Casing (CLP121A-4000)	1
15	07112	Radial Shaft Seal	2	44A	07150-0003*	O-Ring	9
16	07113	O-Ring	2	46	05205	Valve Assembly	6
17	07114	Hexagon Screw (CLP121A)	8	46A	07064	Valve Seat	6
17	07114-0100	Hexagon Screw (CLP121A-4000)	8	46B	07063	Valve Plate	6
20	07116	Taper Roller Bearing	2	46C	07750-0100	Valve Spring	6
20A	07117	Fitting Disc	1-3	46D	07066	Spacer Pipe	6
20B	13001	Fitting Disc	1-3	48	07156	Plug	3
21	05376	Shaft Protector	1	49	05206	Stud bolt	8
21A	05377	Shaft Guard Holder	1	49A	07158	Hexagon Nut	8
22	13242	Crankshaft	1	49B	07159	Disc	8
23	13243	Woodruff Key	1	50	07423	Plug (CLP121A)	1
24	13340	Connecting Rod Assy.	3	50	07423-0100	Plug (CLP121A-4000)	1
24A	13227	Hex Screw	3	50A	07161	Copper Ring (CLP121A)	1
24B	13278	Spring Washer	3	50A	07755-0100	Steel Seal Ring (CLP121A-4000)	1
25	13341	Crosshead / Plunger Assy.	3	52	13020	Disc for Crankshaft	1
28	13232	Crosshead Pin	3	53	06607	Hexagon Screw	1
29A	05200	Spacer Pipe	3	54	13044	Plug, 1" BSP	1
29D	07161A-0100	Seal Ring (CLP121A-4000)	3	55	13322-0100	Plug 1-1/2" BSP	1
29B	07130	Plunger Pipe	3				

CLP121A Pump Repair Kits

Plunger Packing Kit - #09716

<u>Item</u>	<u>Part#</u>	<u>Description</u>	<u>Qty.</u>
36	13291-0020	Leakage Seal	3
38	07140-0003*	O-Ring	3
40	06917	V-Sleeve	9
40A	06918	V-Sleeve, Teflon	6

Valve Assembly Kit- #09608

<u>Item</u>	<u>Part#</u>	<u>Description</u>	<u>Qty.</u>
44A	07150-0003*	O-Ring	9
46A	7064	Valve Seat	6
46B	7063	Valve Plate	6
46C	07750-0100	Valve Spring	6
46D	07066	Spacer Pipe	6

Oil Seal Kit- #09577

<u>Item</u>	<u>Part#</u>	<u>Description</u>	<u>Qty.</u>
31	07133	Oil Seal	3

*NOTE: It is extremely important that these EPDM O-Rings do not come into contact with mineral oil or mineral grease. Use Silicone grease only.

CLP121A Repair Instructions

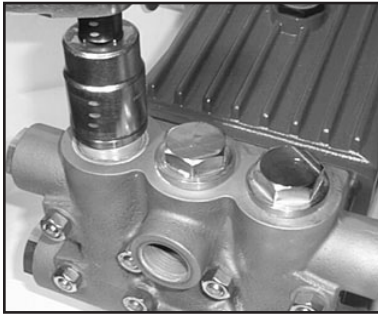

1. With a 30mm wrench, remove the (3) plugs (48).

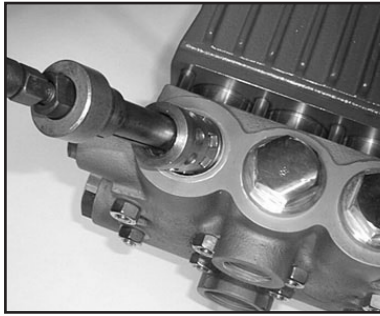

2. Remove the complete valve assembly (46) with valve pullers.

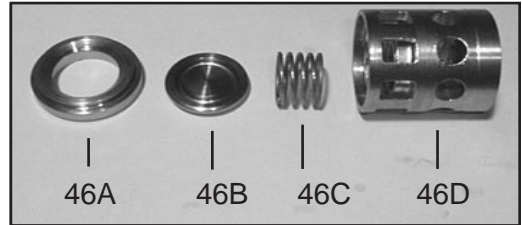

3. Loosen valve seats (46A) from spacer pipe (46D) by lightly hitting the valve plate (46B) with a plastic stick. Check sealing surface and replace worn parts. Reassemble with new o-rings (44A) and oil them before installing. Tighten up tension plugs (48) to 107 ft.-lbs.

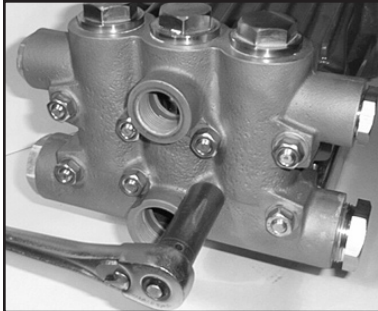

4. Loosen the 8 nuts (49A) with a 19mm wrench. Tap the back of the manifold (43) with a rubber mallet to dislodge and slide off the studs (49).



5. Pull seal sleeves (35) out of guides in crankcase (1).

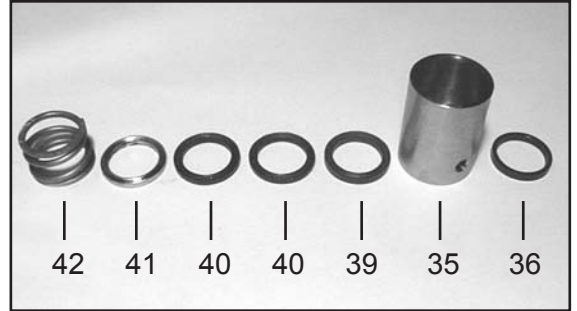

6. Remove the tension spring (42), support ring (41), v-sleeves (40), pressure ring (39), from the seal sleeve (35). Examine seals (36) carefully and replace if worn. Clean all parts.

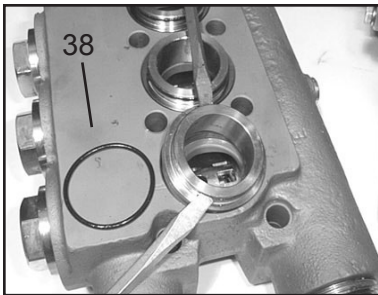

7. Remove seal case (37) from valve casing (43) and inspect o-ring (38).

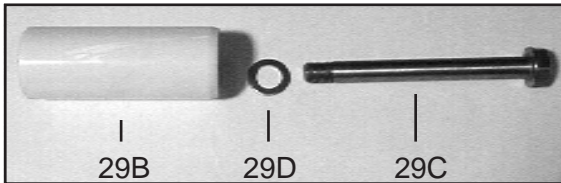

8. Check plunger surface (29B). If plunger pipe is worn, loosen tension screws (29C) and pull off plunger pipe to the front. Clean front surface of plunger (25) thoroughly. Apply a thin coat of Loctite to the tension screw threads (29C). **Note: Care must be taken that no glue gets between the plunger pipe (29B) and the centering sleeve (29A).** Add new copper ring (29D).



9. Place new plunger pipe (29B) carefully through the oiled seals and push seal sleeve (35) with plunger pipe into the crankcase guide. **Note: Make sure weep hole is facing down.**

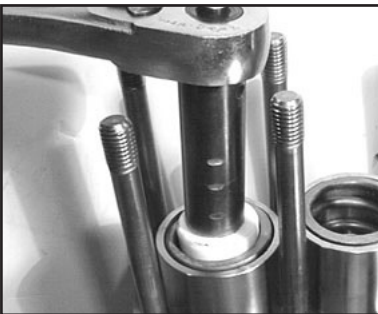

10. Tighten the tension screws (29C) to 310 in.-lbs. The plunger pipe (29B) should not be strained by over tightening of the tension screw (29C) or through damage to the front surface of the plunger; otherwise, it will probably break.

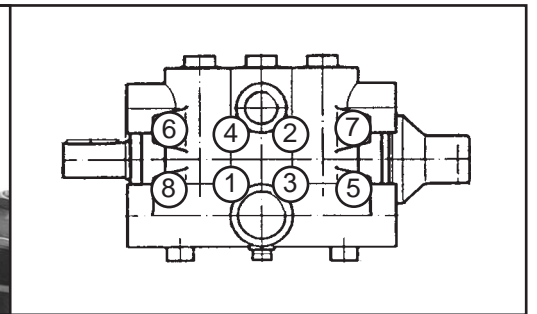
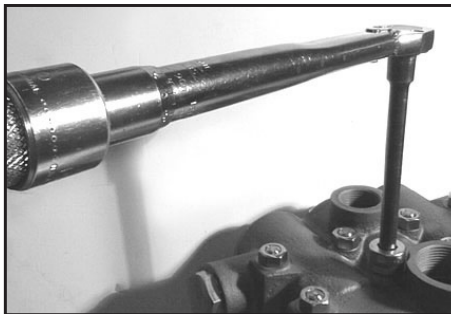

11. Place valve vasing (43) over studs and push firmly until seated against the crankcase (1). Tighten the hexagon nuts (49A) in a crosswise pattern (shown above) to 59 ft.-lbs.

CLP121A Repair Instructions

To Dismantle Gear End

After removing valve casing (43) and plunger pipe (29B), drain oil. Remove gear cover (4) and bearing cover (14). Loosen connecting rod screws (24A) and push the front of the connecting rod (24) forward as far as possible into the crosshead guide.

IMPORTANT! Connecting rods (24) are marked for identification. Do not twist connecting rod halves. Connecting rod is to be reinstalled in the same position on shaft journals.

Turning the crankshaft (22) slightly, hit it out carefully to the side with a rubber hammer.

IMPORTANT! Do not bend the connecting rod (24) shanks. Check crankshaft (22) and connecting rod (24) surfaces, radial shaft seals (15) and taper roller bearings (20).

To Reassemble

Using a soft tool, press in the outer bearing ring until the outer edge lines up with the outer edge of the bearing hole. Remove bearing cover (14) together with radial shaft seal (15) and o-ring (16). Fit crankshaft (22) through bearing hole on the opposite side. Press in outer bearing and tighten it inwards with the bearing cover, keeping the crankshaft in vertical position and turning slowly so that the taper rollers of the bearings touch the edge of the outer bearing ring. Adjust axial bearing clearance to at least 0.1mm and maximum 0.15mm by placing fitting discs (20A and 20B) under the bearing cover.

IMPORTANT! After assembly has been completed, the crankshaft should turn easily with very little clearance. Tighten connecting rod screws (24A) to 310 in.-lbs.

CLP121A Torque Specifications

<u>Position</u>	<u>Item#</u>	<u>Description</u>	<u>Torque Amount</u>
24	13340	Inner Hex Screw, Connecting Rod	310 in.-lbs.
29C	05201	Tension Screw, Plunger	310 in.-lbs.
48	07156	Plug, Discharge	107 ft.-lbs.
49A	07158	Hexagon Nut, Stud Bolts	59 ft.-lbs.

Pump Mounting Selection Guide

Bushings 06496 - 35mm H Bushing
Pulley & Sheaves 07165 - 12.75" Cast Iron - 4 gr. - AB Section
Rails 07357 - Plated Steel Channel Rails (L=11.75"xW1.88"xH=3.00")

CLP121A Dimensions - mm(in)

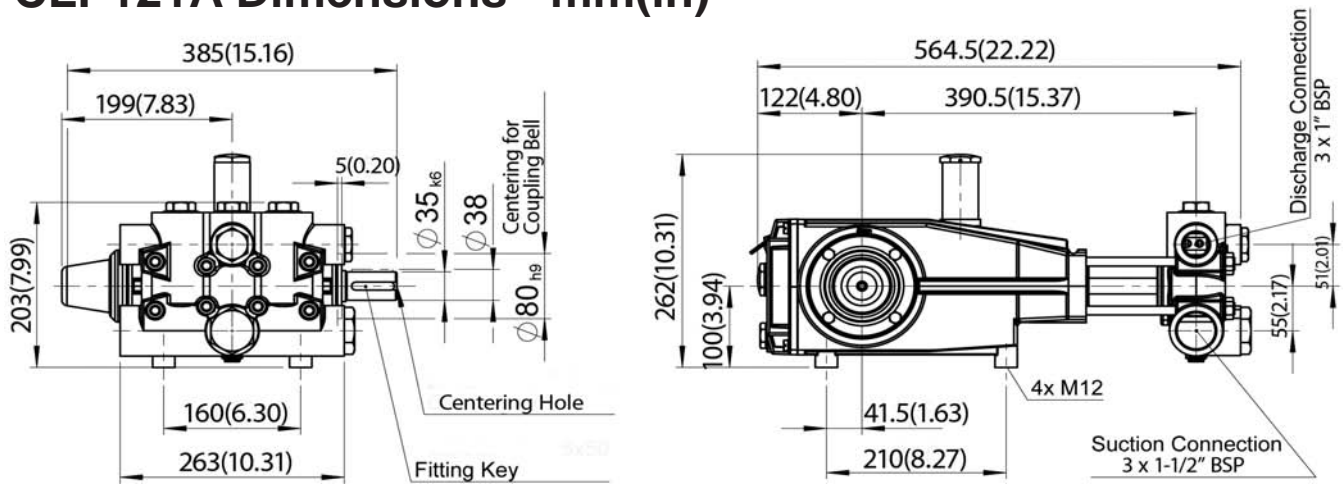

GIANT INDUSTRIES LIMITED WARRANTY

Giant Industries, Inc. pumps and accessories are warranted by the manufacturer to be free from defects in workmanship and material as follows:

1. For portable pressure washers and car wash applications, the discharge manifolds will never fail, period. If they ever fail, we will replace them free of charge. Our other pump parts, used in portable pressure washers and in car wash applications, are warranted for five years from the date of shipment for all pumps used in NON-SALINE, clean water applications.
2. One (1) year from the date of shipment for all other Giant industrial and consumer pumps.
3. Six (6) months from the date of shipment for all rebuilt pumps.
4. Ninety (90) days from the date of shipment for all Giant accessories.

This warranty is limited to repair or replacement of pumps and accessories of which the manufacturer's evaluation shows were defective at the time of shipment by the manufacturer. The following items are NOT covered or will void the warranty:

1. Defects caused by negligence or fault of the buyer or third party.
2. Normal wear and tear to standard wear parts.
3. Use of repair parts other than those manufactured or authorized by Giant.
4. Improper use of the product as a component part.
5. Changes or modifications made by the customer or third party.
6. The operation of pumps and or accessories exceeding the specifications set forth in the Operations Manuals provided by Giant Industries, Inc.

Liability under this warranty is on all non-wear parts and limited to the replacement or repair of those products returned freight prepaid to Giant Industries which are deemed to be defective due to workmanship or failure of material. A Returned Goods Authorization (R.G.A.) number and completed warranty evaluation form is required prior to the return to Giant Industries of all products under warranty consideration. Call (419)-531-4600 or fax (419)-531-6836 to obtain an R.G.A. number.

Repair or replacement of defective products as provided is the sole and exclusive remedy provided hereunder and the MANUFACTURER SHALL NOT BE LIABLE FOR FURTHER LOSS, DAMAGES, OR EXPENSES, INCLUDING INCIDENTAL AND CONSEQUENTIAL DAMAGES DIRECTLY OR INDIRECTLY ARISING FROM THE SALE OR USE OF THIS PRODUCT.

THE LIMITED WARRANTY SET FORTH HEREIN IS IN LIEU OF ALL OTHER WARRANTIES OR REPRESENTATION, EXPRESS OR IMPLIED, INCLUDING WITHOUT LIMITATION ANY WARRANTIES OR MERCHANTABILITY OR FITNESS FOR A PARTICULAR PURPOSE AND ALL SUCH WARRANTIES ARE HEREBY DISCLAIMED AND EXCLUDED BY THE MANUFACTURER.

