



Operation & Parts Manual

MODEL 638AL LEVER ACTION BOTTOM INLET PUMP



CAUTION

Special Applications - Edson pumps are used for many diverse applications. Some may require special parts or maintenance procedure. i.e.. pumping liquid with gasoline or other fuels requires using Viton diaphragms and valves. If you have any questions regarding procedures for your application, call Edson customer service.

Set Up

Installing the Pump

1. Install the pump in a manner that allows for a comfortable position for pumping and easy access for inspection and maintenance.
2. The head ring and drive arm can be rotated to the four 90 degree positions allowed by the square bolt pattern.
3. The pump is designed to be installed on a relatively horizontal surface using 1/4 " bolts or screws at the four corners of the base. If the mounting surface can not be horizontal, the inlet port should be lower than the discharge.
4. Do not combine incompatible metals i.e.. no aluminum fittings on a bronze pump or bronze fittings on an aluminum pump.
5. Check that all nuts and bolts are tight.

Installing the Plumbing

1. Fittings and hose couplings must be air tight. Threads must be sealed with pipe sealer.
2. To avoid clogging, the discharge should be the same size or larger than the inlet.
3. Connect plumbing to the pump using unions or easily removed couplings.
4. For sewage and sump applications using backup check valves on the inlet and discharge will improve the ability of the pump to dry prime.
5. For sewage and sump applications where the discharge drains naturally down and away from the pump installing a positive loop will improve the self priming feature. When you stop pumping the loop traps some liquid against the discharge valve improving the seal. Fig. 1
6. When discharging to a point higher than the pump, install the discharge plumbing so that no air can be trapped in the plumbing. Fig. 2 & 3. Trapped air restricts the flow of liquid and requires more work to pump liquid past the air lock.
7. If the pump is being installed to pump liquids with suspended solids and the use will be intermittent, solid matter can get trapped under the check valves. This will prevent self priming at the next use. Flushing with water will generally clear out the solid matter. Installing secondary clear flapper check valves right at the inlet and discharge will improve the dry suction start performance of the pump. Order Edson Clear Check Valve 269CL-150.

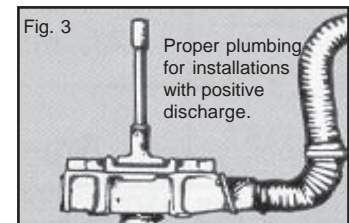
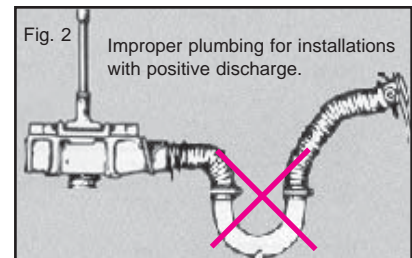
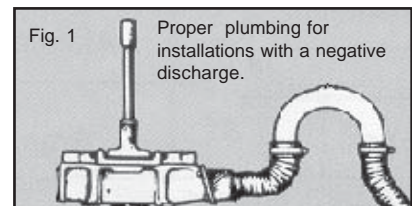

Operation

The Pump Works By:

1. Pulling back on the handle raises the diaphragm creating a vacuum .
2. The vacuum pulls the discharge valve assembly closed.
3. Atmospheric pressure pushes liquid up the inlet plumbing to fill the vacuum.
4. Pushing forward on the handle compresses the air and liquid under the diaphragm closing the inlet check valve and forcing the air and liquid out the discharge.
5. The closing of the inlet valve assembly prevents the liquid and air trapped in the inlet line from dropping back to atmosphere.

Pump Performance Depends On:

1. An air tight diaphragm.
2. Valve assemblies that seal well on the pump inlet and discharge valve seats.
3. Inlet plumbing that is air tight all the way to the point it is submersed in the liquid.

Suction Stroke

Inlet Valve Assembly: opens into the pump

Discharge Valve Assembly: closes and seals on the valve seat that is part of the pump base under the discharge chamber.

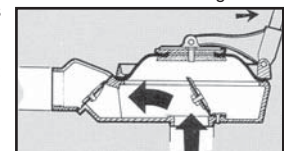

Discharge Stroke

Discharge Valve Assembly: opens away from the pump

Inlet Valve Assembly: closes and seals on the valve seat that is part of the inlet chamber.

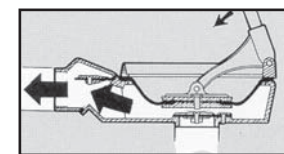

Parts

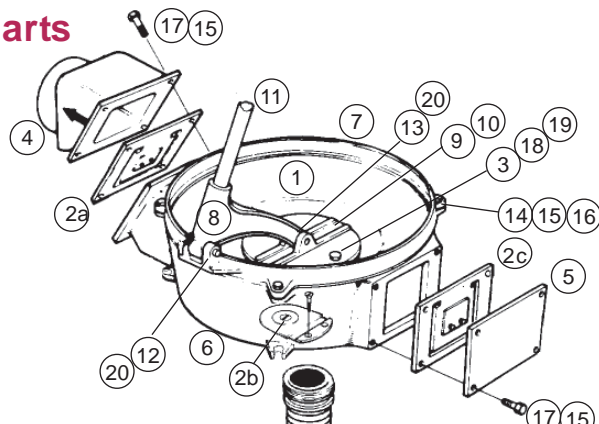

Pump Spares Kits:

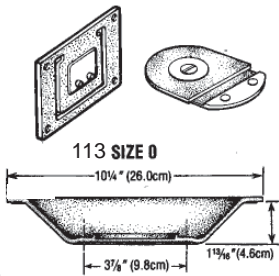

Bottom Inlet Nitrile Pump Spares Kit
 Order # 114N-638-554 Includes:
 113N-0 Size 0 Diaphragm - Nitrile
 160-G-107 Valve Assembly - Nitrile (1)
 160-G-108 Valve Assembly - Nitrile (1)
 160-A-1200 3/8" Sealing Washer - Stainless (2)

Bottom Inlet Hypalon Pump Spares Kit
 Order # 114H-638-554 Includes:
 113H-0 Size 0 Diaphragm - Hypalon
 160-G-107 Valve Assembly - Nitrile (1)
 160-G-108 Valve Assembly - Nitrile (1)
 160-A-1200 3/8" Sealing Washer - Stainless (2)

Bottom Inlet Viton Pump Spares Kit
 Order # 114V-638-554 Includes:
 113V-0 Size 0 Diaphragm - Viton
 160-G-107V Valve Assembly - Viton (1)
 160-G-108V Valve Assembly - Viton (1)
 160-A-1200 3/8" Sealing Washer - Stainless (2)

638AL-200 Parts:

Key #	Part No.	Description	Qty
1	113N-0	Size 0 Diaphragm - Nitrile	1
2a	160-G-107	Valve Assembly	1
2b	160-G-108	Bottom Inlet Valve Assembly	1
2c	160-A-21N	Inspection Plate Gasket	1
3	160-A-1200	3/8" Sealing Washer - Stainless	2
4	160-B-50A-200	2" Discharge Chamber- Alum.	1
5	160-A-730	Inspection Plate - Alum.	1
6	160-C-190	Bottom Inlet Pump Base - Alum.	1
7	160-C-4A	Heading Alum.	1
8	160-B-28A	Drive Arm - Alum.	1
9	160-A-1A	Upper Standard - Alum.	1
10	160-A-906	Lower Standard-SS (not visible in drawing)	1
11	160-A-41ST	32" Pump Handle with Grip	1
12	960-A-1315C	Head Ring Pivot Pin	1
13	960-A-1315E	Standard Pivot Pin	1
14	F1/4-1.75-SC	1/4-20 X 1.75 Socket Head Cap Srew Stainless	4
15	F1/4-FN	1/4-20 Nut Stainless	8
16	F1/4-LW	1/4" Lock Washer	4
17	F1/4-1-SC	1/4-20 X 1" Socket Head Cap Screw Stainless	4
18	F3/8-LW	3/8" Lock Washer	2
19	F3/8-1-HH	3/8-16X1" HHCS Stainless	2
20		1/8" X 3/4" Cotter Pin Stainless	4

638AL-150 Parts: same as above except for the following:

Key #	Part No.	Description	Qty
4	160-B-50A-150	1 1/2" Discharge Chamber- Alum.	1

Optional Parts substituted upon request:

Key #	Part No.	Description	Qty
1	113H-0	Size 0 Diaphragm - Hypalon	1
1	113V-0	Size 0 Diaphragm - Viton	1
2a	160-G-107V	Valve Assembly - Viton	1
2b	160-G-108V	Bottom Inlet Valve Assembly - Viton	1
2c	160-A-21V	Inspection Plate Sealing Gasket	1

Maintenance & Trouble Shooting

PUMPS USED FOR CRITICAL APPLICATIONS SHOULD BE INSPECTED AND TESTED OFTEN.

For boat applications at least every six months and at annual commissioning and prior to off shore passage.

Visually Inspect Pump Inside and Out for Corrosion and Wear. Lightly Oil Pivot Pins. Pump Some Water.

If the pump does not pump check first for anything blocking the inlet line. If clear then see instructions below :

1. To check status of the pump and inlet plumbing all at once, seal the open end of the inlet plumbing. If you have a vacuum gage, connect it to the open end of the inlet plumbing. Start pumping. If the plumbing is air tight, you should be able to build a vacuum of 9 to 10 inches of mercury. When you stop pumping the vacuum should very slowly bleed off. This procedure requires inlet plumbing of at least 4 ft. in length. If you can not establish or hold vacuum in the system proceed to step 2.
2. Remove all plumbing from the pump.
3. To check the discharge valve assembly and diaphragm put your hand tightly over the pump inlet and pull back on the handle. You should feel a vacuum suction and if the discharge valve assembly and diaphragm are working properly, you should not be able to raise the diaphragm all the way. If you do not feel any suction, do the same thing again and listen for air being sucked in around the diaphragm. If you hear air movement, inspect for loose bolts or worn diaphragm. If you hear no air movement, remove the discharge chamber and inspect the valve assembly and valve seat. Clean or replace the valve and clean or resurface the valve seat as appropriate.
4. To check the inlet valve assembly raise the diaphragm; put your hand over the discharge and push forward on the handle. If the inlet valve is sealing properly, you should feel the pressure against your hand. If you don't, then remove the inlet chamber and inspect the valve assembly and valve seat. Clean or replace the valve and clean or resurface the valve seat as appropriate.
5. When you are sure the pump is working properly and the pump still will not pump liquid, check the inlet plumbing for leaks. Depending on the height above the liquid even one unsealed fitting can prevent liquid from getting to the pump.

Performance & Specifications

Static Head: Suction-15 ft / 4.57m Discharge-15 ft / 4.57m
 Dry Suction Lift: 12ft./3.65m
 Volume: 1 Gallon per Stroke at 5 ft Suction Lift and 0 Discharge

Total Volume depends on the pumping speed and the conditions when pumping. A Cycle is one complete raising and lowering of the diaphragm. Static Head is determined by the vertical height, length and size of the plumbing and the viscosity of the liquid. For most manual pump applications just measure the vertical distance between the liquid being pumped and the inlet of the pump. If it is within 15ft. then you should be able to pump the liquid. See Installation Guidelines for other considerations.

