

Instruction

Disassembling and assembling PAH 2-6.3, PAHT 2-6.3 and PAHT G 2-6.3



Table of Contents

1.	Disassembling	3
2.	Inspection	7
2.1	Port plate and valve plate	7
2.2	Pistons	7
2.3	Cylinder barrel	8
2.4	Housing	8
2.5	Swash plate	9
3.	Assembling	10
4.	Spare parts list for PAH 2 / PAHT 2	18
5.	Exploded view PAH 2 / PAHT 2	19
6.	Spare parts list for PAHT G 2	20
7.	Exploded view PAHT G 2	21
8.	Spare parts list for PAH 4-6.3 / PAHT 3.2-6.3	22
9.	Exploded view PAH 4-6.3 / PAHT 3.2-6.3	23
10.	Spare parts list for PAHT G 3.2-6.3	24
11.	Exploded view PAHT G 3.2-6.3	25
12.	Tool sets	26

Note:

If the pump is dismantled during the warranty period, the pump is no longer under warranty.

This document covers the instructions for disassembling and assembling the axial piston pumps PAH / PAHT / PAHT G 2-6.3.

Tools provided with tool set 180Z0235:

- Shaft bush, torpedo
- Press bush Ø18 (Plastic)

1. Disassembling

1. Tools required for dismantling.

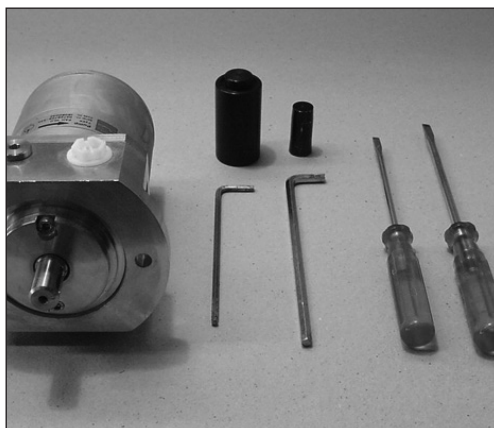

2. Remove the parallel key and unscrew the front cover.



3. Dismantle the front cover using a vice.

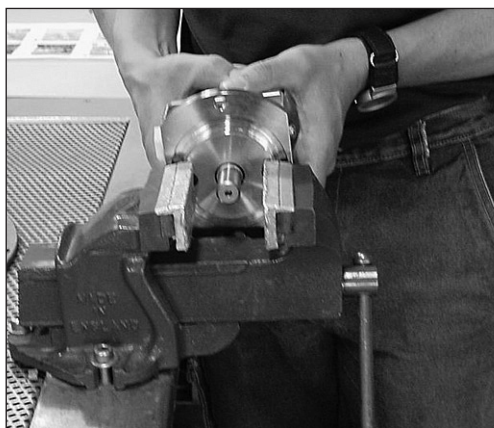

4. Remove the shaft seal using two screwdrivers.

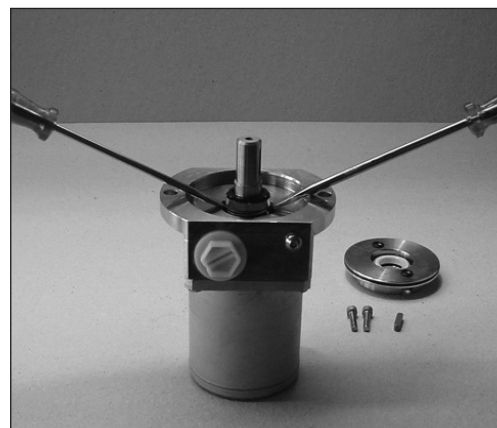

5. Remove the two small O-rings from the flange. Remove the seal from the front cover using a screwdriver.

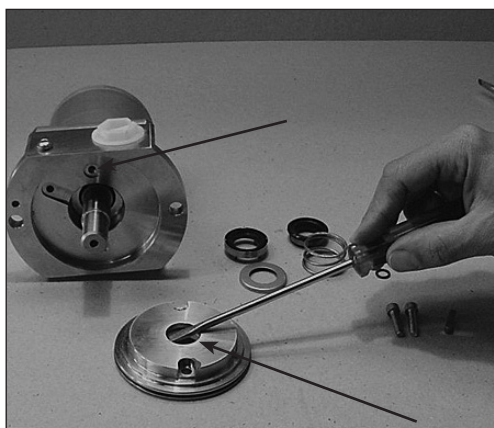

6. Unscrew the four screws for the housing.

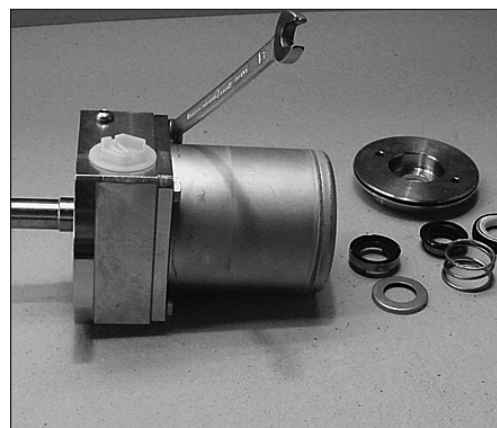

7. Remove the housing.

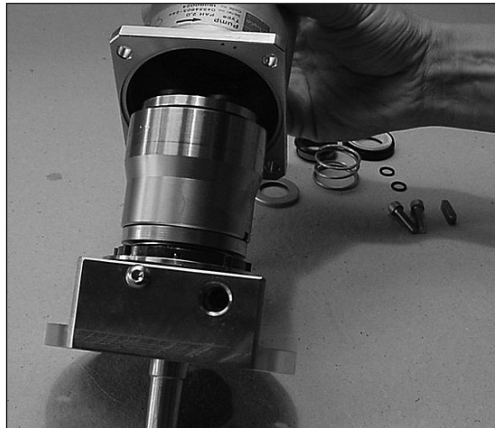

8. Remove the cylinder barrel.



9. Remove the pistons and the retaining plate from the cylinder barrel.



NB: Items 10.1.a. and 10.1.b. concern PAH 2, PAHT 2 and PAHT G 2 only

10.1.a. Remove the spring.



10.1.b. Remove the stop.



NB: Items 10.2.a. through 10.2.c. concern PAH 4-6.3, PAHT 3.2-6.3 and PAHT G 3.2-6.3 only

10.2.a. Remove the retaining guide.



10.2.b. Remove the spring guide.



10.2.c. Remove the spring.



NB: The following items concern PAH 2-6.3, PAHT 2-6.3 and PAHT G 2-6.3 only

11. Loosen the valve plate using two screwdrivers. Place one of the screwdrivers in the slot of the valve plate.

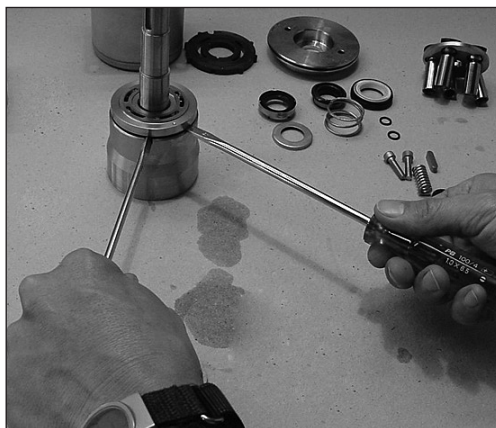

12. Remove the valve plate.



13. Remove the five O-rings and the five back-up O-rings.

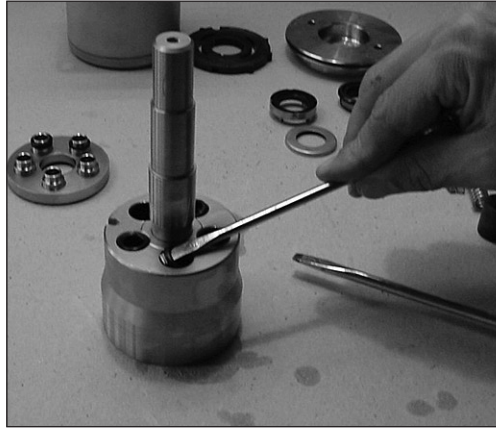

14. Remove the port plate from the flange.

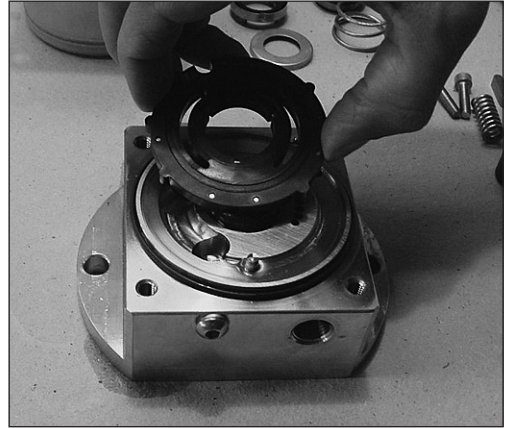

15. Wash all parts and replace all seals (inclusive shaft seal).

16. Inspect all parts carefully (see "Inspection") and replace any worn parts.

17. If the pump has failed, the reason for the failure must be found and fixed before the repaired pump is re-installed.



2. Inspection
2.1 Port plate and valve plate

1. Neither port plate nor valve plate must show any sign of wear.

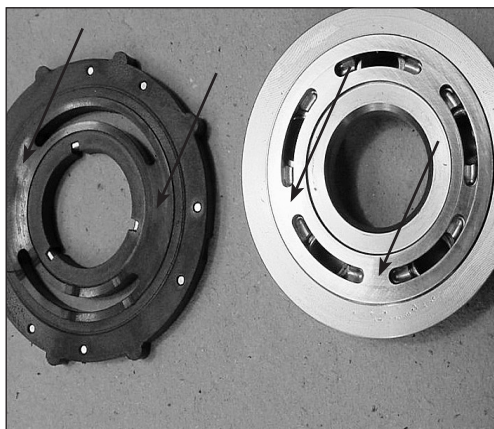

2. Hold a ruler against the surface of the plates and check the tightness against a light source.



3. Check that both O-rings and back-up rings are not broken and do not show severe wear.

2.2 Pistons

1. The play in the ball and socket joint must not exceed 0.1 mm.

2. The thickness of the piston shoes must be at least 2.85 mm.

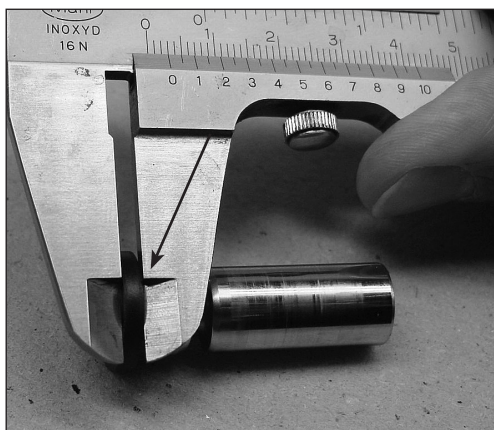

3. Hold a ruler against the surfaces of the piston shoes to check that the surfaces are even and smooth and without any scratches.



4. **PAHT only:**
It is acceptable that the (black) treated surfaces of the pistons are partly worn off.

2.3 Cylinder barrel

1. Check the outer bearing surface for large wear grooves (not critical).
2. Check that the bushings are free from seizure and large scratches.

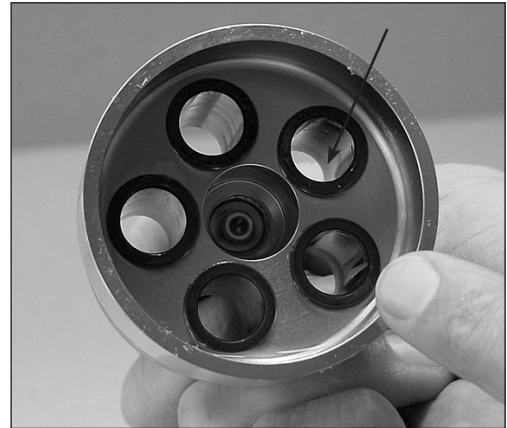

3. Ensure that the pistons can move freely in the bushings.

2.4 Housing

1. Check that the swash plate surface is smooth and without any big scratches (depth more than 0.1 mm).
2. Check the bearing (the black part) for large wear grooves (not critical).



2.5 Swash plate

Mounted swash plate:

1. Unscrew center bolt from the swash plate.

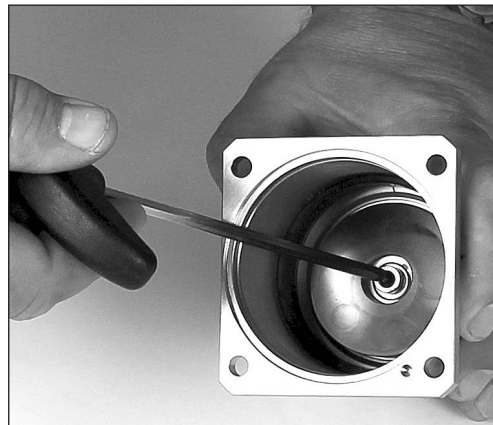

2. Remove swash plate and guide pin.

Guide pin

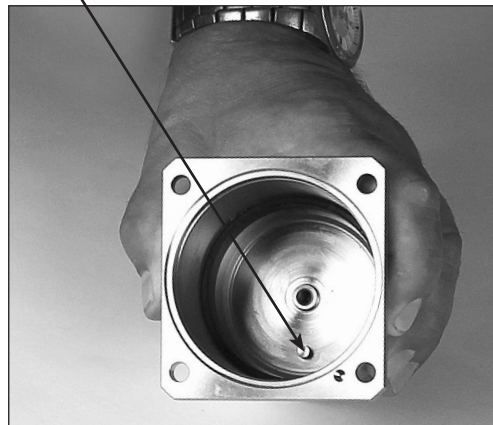

3. Assembling

WARNING:
Do not use silicone when assembling the pump. Do not reuse disassembled O-rings; they might be damaged. Always use new O-rings.

Important:
It is essential that the pump is serviced in conditions of absolute cleanliness. All parts must be absolute clean before mounting.

1. Lubrication:
 - To prevent seizing-up, lubricate all threads with PTFE lubrication type.
 - O-rings inside pump may be lubricated only with clean filtered water.
 - O-rings for port flange, mounting flange and flushing valve must be lubricated.
 - It is important to lubricate ALL parts to be assembled with clean filtered water (Especially all PEEK parts).

2. Parts and tools required for assembly.

Check that all parts are OK.
Replace all seals.

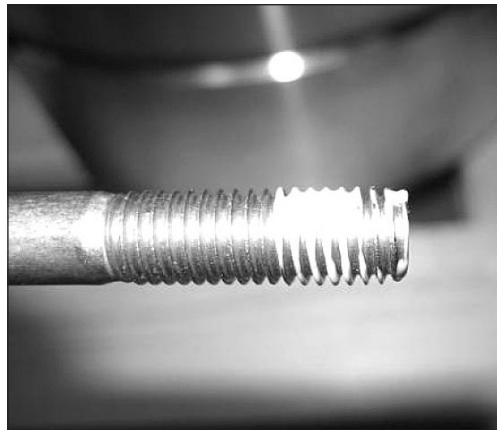

3. Mount the O-ring on the flange.

4. Mount the port plate in its right position using the pin as guide.

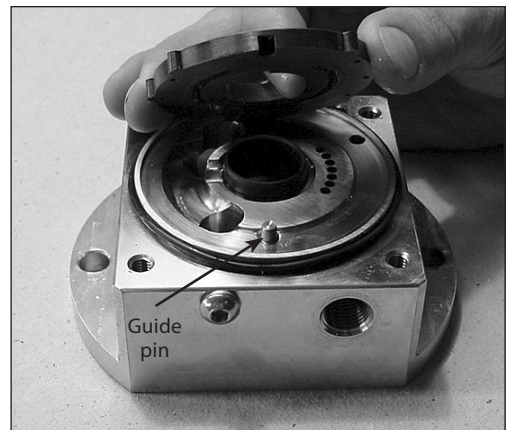
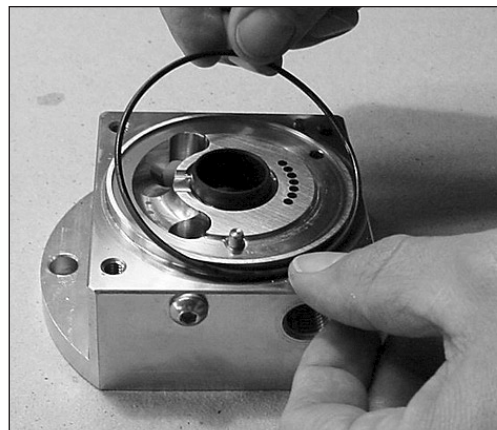

5. Mount the valve plate with seals on the cylinder barrel.



6. Press the valve plate into the cylinder barrel using a piece of plastic.



7. Check that the gap between the cylinder barrel and the valve plate is 1.5-2.5 mm.



8. Mount the cylinder barrel in the flange.

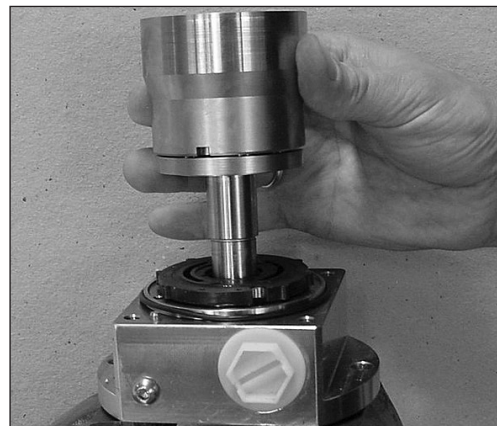

9.1 NB: Items 9.1.a through 9.1.c concern PAH 2, PAHT 2 and PAHT G 2 only

9.1.a Mount the stop.



9.1.b Mount the spring in the centre hole.



9.1.c Mount the retaining plate.



9.2 NB: Items 9.2.a through 9.2.d concern PAH 4-6.3, PAHT 3.2-6.3 and PAHT G 3.2-6.3 only

9.2.a Mount the spring in the centre hole.



9.2.b Mount the spring guide.



9.2.c Mount the retainer guide on the spring guide.



9.2.d Mount the retaining plate on the retainer guide.



9.3 NB: The following items concern PAH 2-6.3, PAHT 2-6.3 and PAHT G 2-6.3 only

10. Insert the pistons.

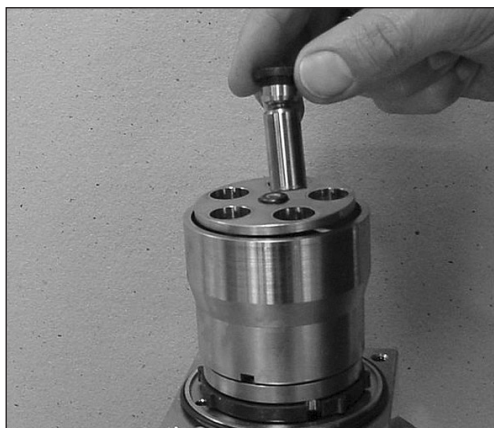

11. All pistons inserted.



12. Place pin and place swash plate fitted on guide pin and center hole.

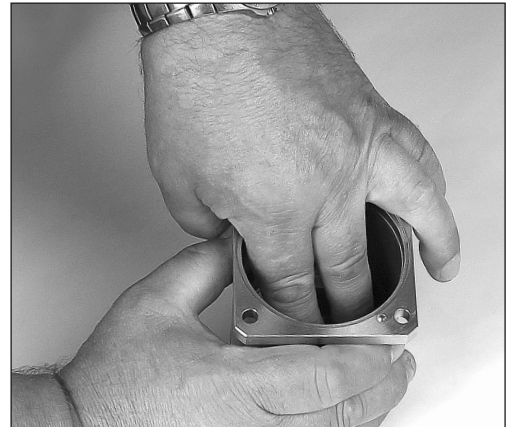
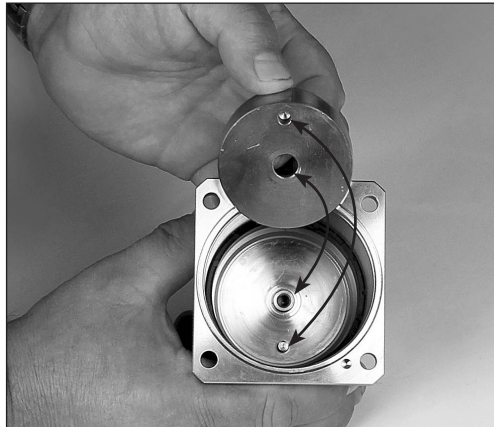

13. Place the screw in the center hole.

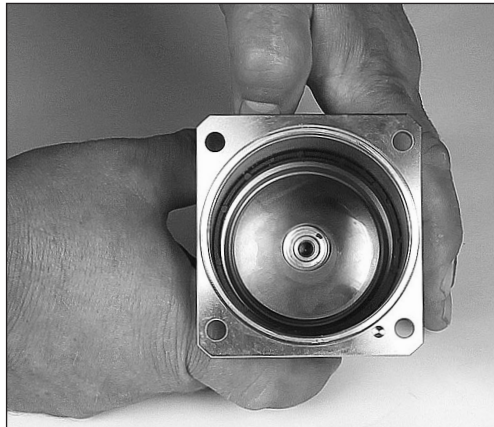

14. Tighten to a torque of 10 ± 1 Nm.



15. Mount the pump housing using the pin as guide.

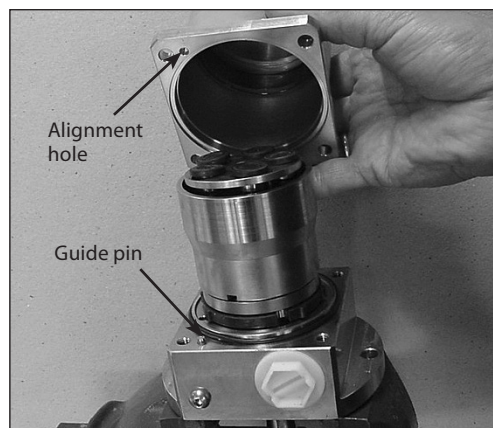

16. Press the housing down by hand and insert the screws.



17. Tighten the screws to a torque of 13 Nm.

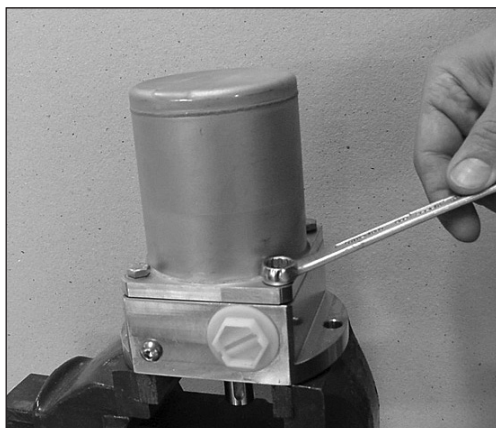

18. Mount the two O-rings in the flange and the O-ring on the front cover.

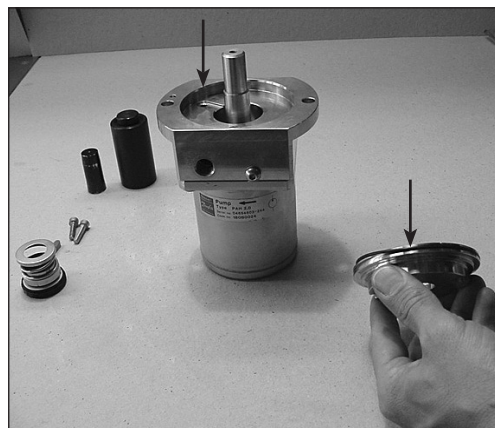

19. Wet the shaft seal with water and mount it in the front cover. Ensure that it is pressed to the bottom.



20. Mount the washer with the edge pointing upwards.

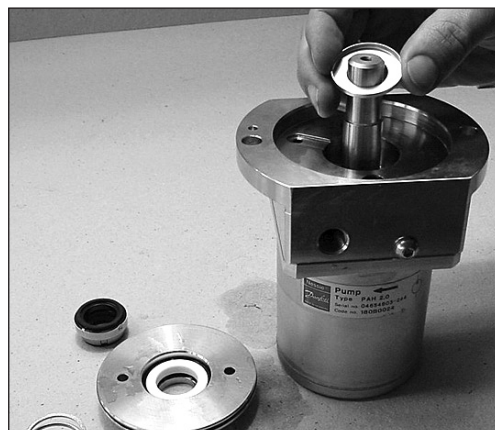

21. Mount the spring.



22. Fit the hollow bush onto the shaft.



23. Wet the shaft seal and slide it over the bush.



24. Use the shaft seal tool when pressing the shaft seal downwards.

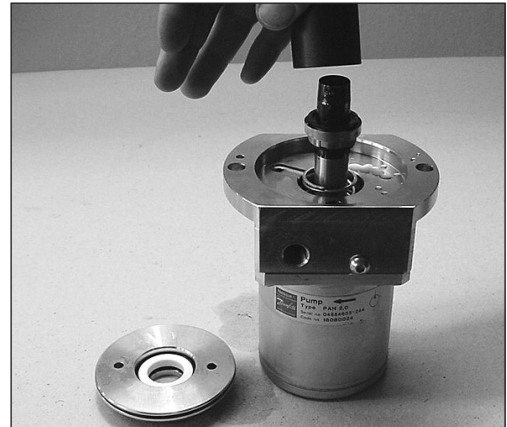

25. Press the shaft seal in position.

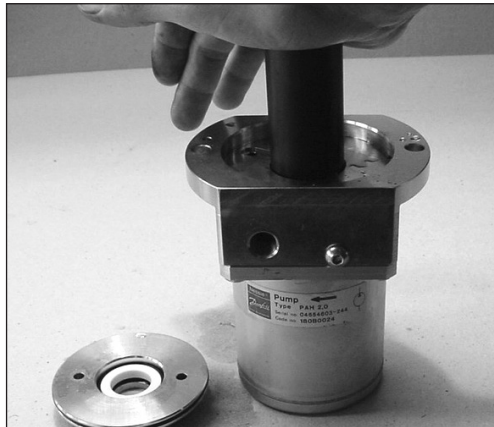

26. Remove the bush.

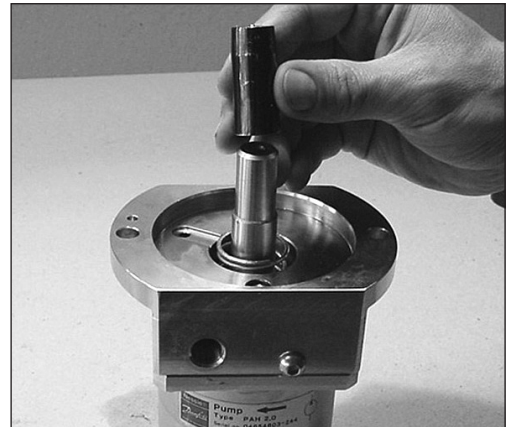

27. Mount the front cover and align it to the screw holes.

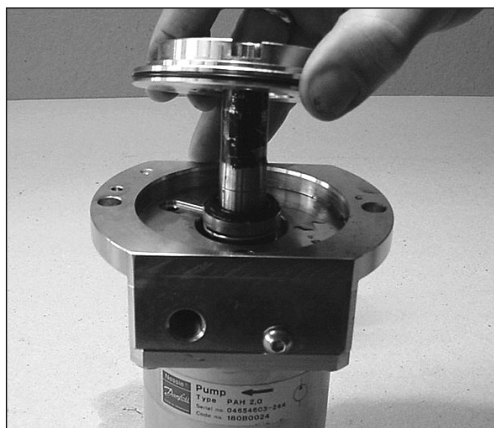

28. Tighten the screws to a torque of 7 Nm.

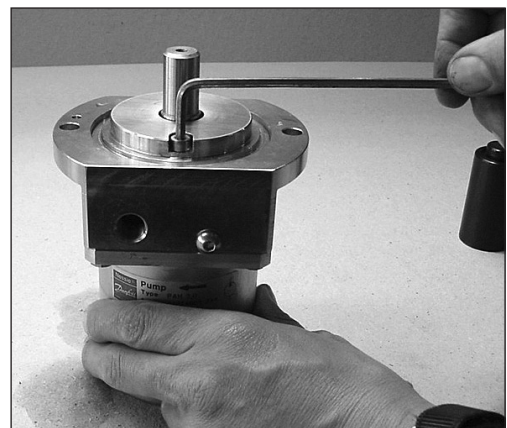

4. Spare parts list for PAH 2 / PAHT 2

Pos.	Qty.	Designation	Material	180B4100 - Seal set (PAH 2-6.3 / PAHT 2-6.3)	180B4104 - Cylinder barrel set (PAHT 2-6.3)	180B4112 - Cylinder barrel set (PAH2-6.3)	180B4101 - Valve plate set (PAH 2-6.3 / PAHT 2-6.3)	180B4102 - Piston set (PAHT 2)	180B4110 - Piston set (PAH 2-6.3)	180B4301 - Swash plate set (PAH 2 / PAHT 2)
1	1	Housing	AISI 304 / PEEK							
2	1	Pin Ø5 x 10	AISI 316	x						
5	4	Screw M6 x 16	AISI 316	x						
31	1	Swash plate	AISI 431							x
32	1	Screw M6 x 8	AISI 304							x
33	1	Washer	AISI 304							x
34	1	Pin Ø4 x 8	AISI 316							x
61	1	Cylinder barrel	AISI 431 / PEEK		x	x				
62	1	Spring	AISI 304					x	x	
63	1	Spring guide	PEEK							
64	1	Retainer ball	PEEK							
65	1	Retainer plate	1.4301					x	x	
66	5	Piston	AISI 431/ PEEK					x	x	
67	1	Key 5 x 5 x 20	AISI 316Ti	x						
69	1	Stop	PEEK					x	x	
91	1	Port plate	AISI 304 / PEEK				x			
92	1	Valve plate	AISI 431				x			
93	5	Back up ring	PTFE				x			
94	5	O-ring Ø8,73 x Ø1,78	NBR				x			
121	1	Port flange	AISI 304 / PEEK							
122	1	O-ring Ø70 x Ø2,72	NBR	x						
123	1	O-ring Ø75,92 x Ø1,78	NBR	x						
124	1	Shaft seal	AISI 304 / NBR	x						
125	1	End cover	AISI 304							
126	1	Pin Ø4 x 8	AISI 316							
127	2	Screw M5 x 20	AISI 304	x						
136	2	O-ring Ø7 x Ø1,5	NBR	x						
	1	Service instruction		x	x	x	x	x	x	x

5. Exploded view
PAH 2 / PAHT 2

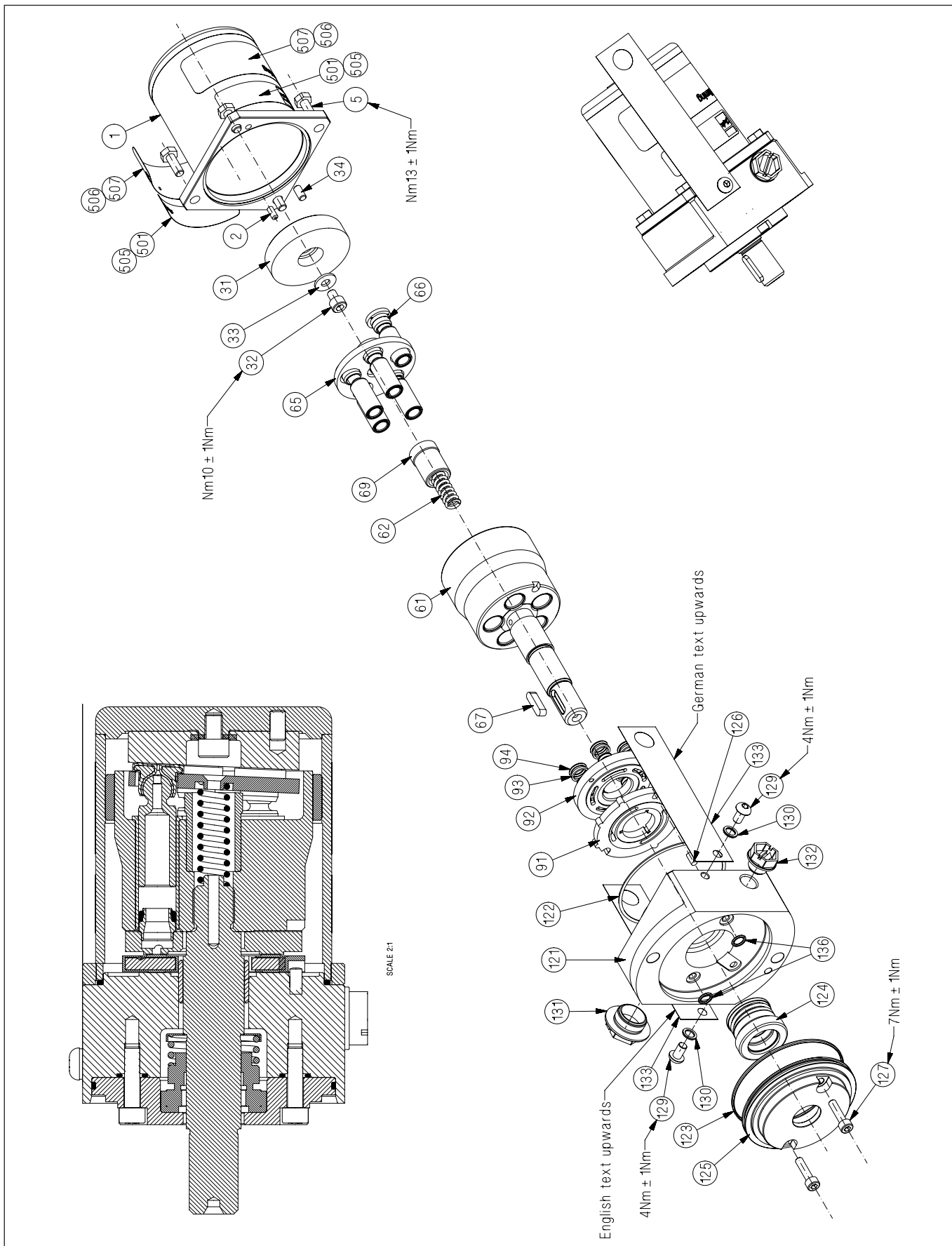

6. Spare parts list for PAHT G 2

Pos.	Qty.	Designation	Material	180B4307 - Seal set (PAHT G 2-6.3)	180B4311 - Cylinder barrel set (PAHT G 2-6.3)	180B4308 - Valve plate set (PAHT G 2-6.3)	180B4309 - Piston set (PAHT G 2)	180B4310 - Piston set (PAHT G 3.2-6.3)	180B4317 - Swash plate set (PAHT G 2)
1	1	Housing	AISI 304 / PEEK						
2	1	Pin Ø5 x 10	AISI 316	x					
5	4	Screw M6 x 16	AISI 316	x					
31	1	Swash plate	AISI 431						x
32	1	Screw M6 x 8	AISI 304						x
33	1	Washer	AISI 304						x
34	1	Pin Ø4 x 8	AISI 316						x
61	1	Cylinder barrel	AISI 431 / PEEK		x				
62	1	Spring	AISI 304				x	x	
63	1	Spring guide	PEEK					x	
64	1	Retainer ball	PEEK					x	
65	1	Retainer plate	1.4301				x	x	
66	5	Piston	AISI 431/ PEEK				x	x	
67	1	Key 5 x 5 x 20	AISI 316Ti	x					
69	1	Stop	PEEK				x		
91	1	Port plate	AISI 304 / PEEK			x			
92	1	Valve plate	AISI 431			x			
93	5	Back up ring	PTFE			x			
94	5	O-ring Ø8,73 x Ø1,78	NBR			x			
121	1	Port flange	AISI 304 / PEEK						
122	1	O-ring Ø70 x Ø2,72	NBR	x					
123	1	O-ring Ø75,92 x Ø1,78	NBR	x					
124	1	Shaft seal	AISI 304 / NBR	x					
125	1	End cover	AISI 304						
126	1	Pin Ø4 x 8	AISI 316						
127	2	Screw M5 x 20	AISI 304	x					
136	2	O-ring Ø7 x Ø1,5	NBR	x					
	1	Service instruction		x	x	x	x	x	x

7. Exploded view
PAHT G 2

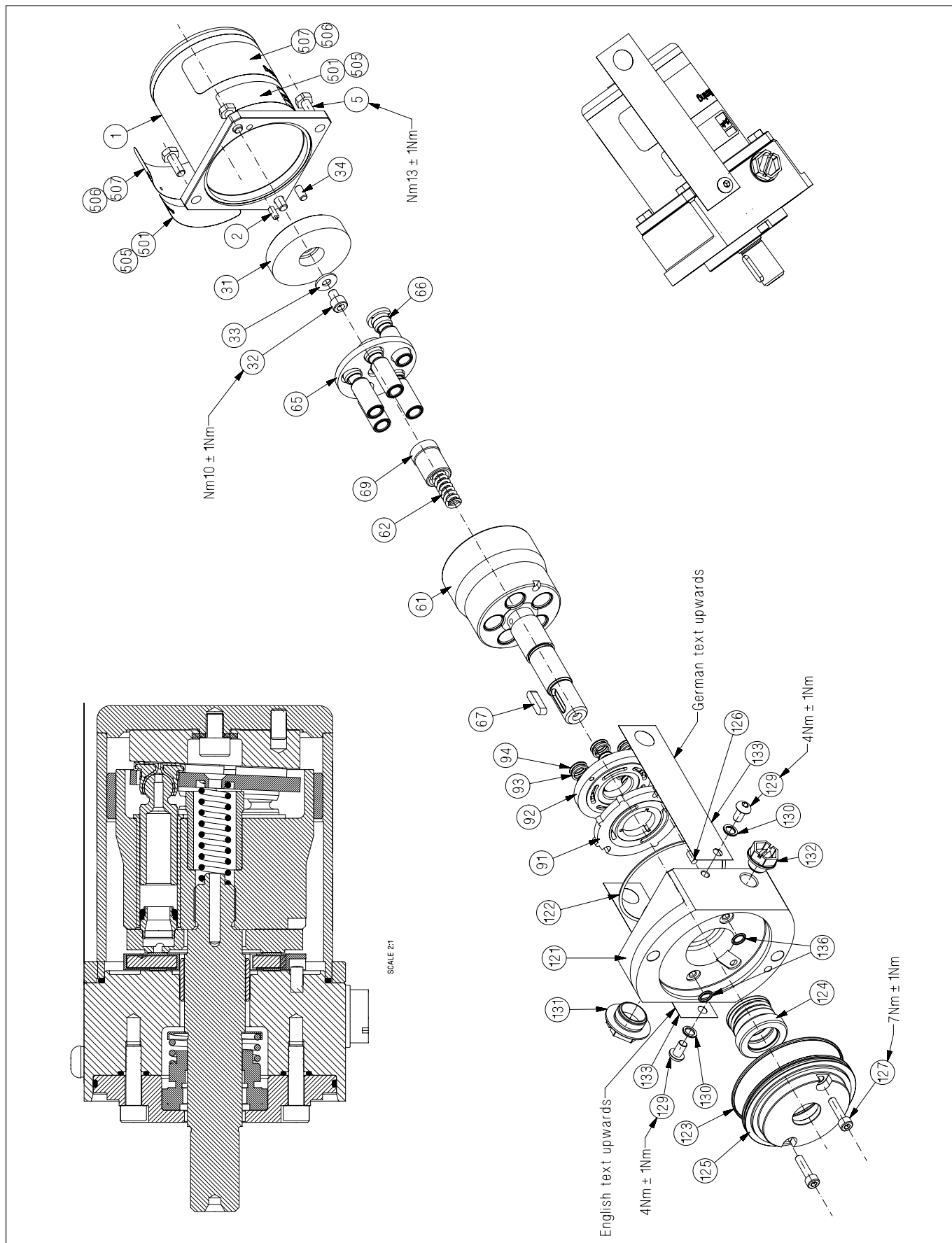

**8. Spare parts list for
PAH 4-6.3 / PAHT 3.2-6.3**

Pos.	Qty.	Designation	Material	180B4100 - Seal set (PAH 2-6.3 / PAHT 2-6.3)	180B4104 - Cylinder barrel set (PAHT 2-6.3)	180B4112 - Cylinder barrel set (PAH 2-6.3)	180B4101 - Valve plate set (PAH 2-6.3 / PAHT 2-6.3)	180B4103 - Piston set (PAHT 3.2-6.3)	180B4110 - Piston set (PAH 2-6.3)	180B4302 - Swash plate set (PAHT 3.2)	180B4303 - Swash plate set (PAH 4 / PAHT 4)	180B4304 - Swash plate set (PAH 6.3 / PAHT 6.3)
1	1	Housing	AISI 304 / PEEK									
2	1	Pin Ø5 x 10	AISI 316	x								
5	4	Screw M6 x 16	AISI 316	x								
31	1	Swash plate	AISI 431							x	x	x
32	1	Screw M6 x 8	AISI 304							x	x	x
33	1	Washer	AISI 304							x	x	x
34	1	Pin Ø4 x 8	AISI 316							x	x	x
61	1	Cylinder barrel	AISI 431 / PEEK		x	x						
62	1	Spring	AISI 304					x	x			
63	1	Spring guide	PEEK					x	x			
64	1	Retainer ball	PEEK					x	x			
65	1	Retainer plate	1.4301					x	x			
66	5	Piston	AISI 431/ PEEK					x	x			
67	1	Key 5 x 5 x 20	AISI 316Ti	x								
69	1	Stop	PEEK									
91	1	Port plate	AISI 304 / PEEK				x					
92	1	Valve plate	AISI 431				x					
93	5	Back up ring	PTFE				x					
94	5	O-ring Ø8,73 x Ø1,78	NBR				x					
121	1	Port flange	AISI 304 / PEEK									
122	1	O-ring Ø70 x Ø2,72	NBR	x								
123	1	O-ring Ø75,92 x Ø1,78	NBR	x								
124	1	Shaft seal	AISI 304 / NBR	x								
125	1	End cover	AISI 304									
126	1	Pin Ø4 x 8	AISI 316									
127	2	Screw M5 x 20	AISI 304	x								
136	2	O-ring Ø7 x Ø1,5	NBR	x								
	1	Service instruction		x	x	x	x	x	x	x	x	x

9. Exploded view
PAH 4-6.3 / PAHT 3.2-6.3

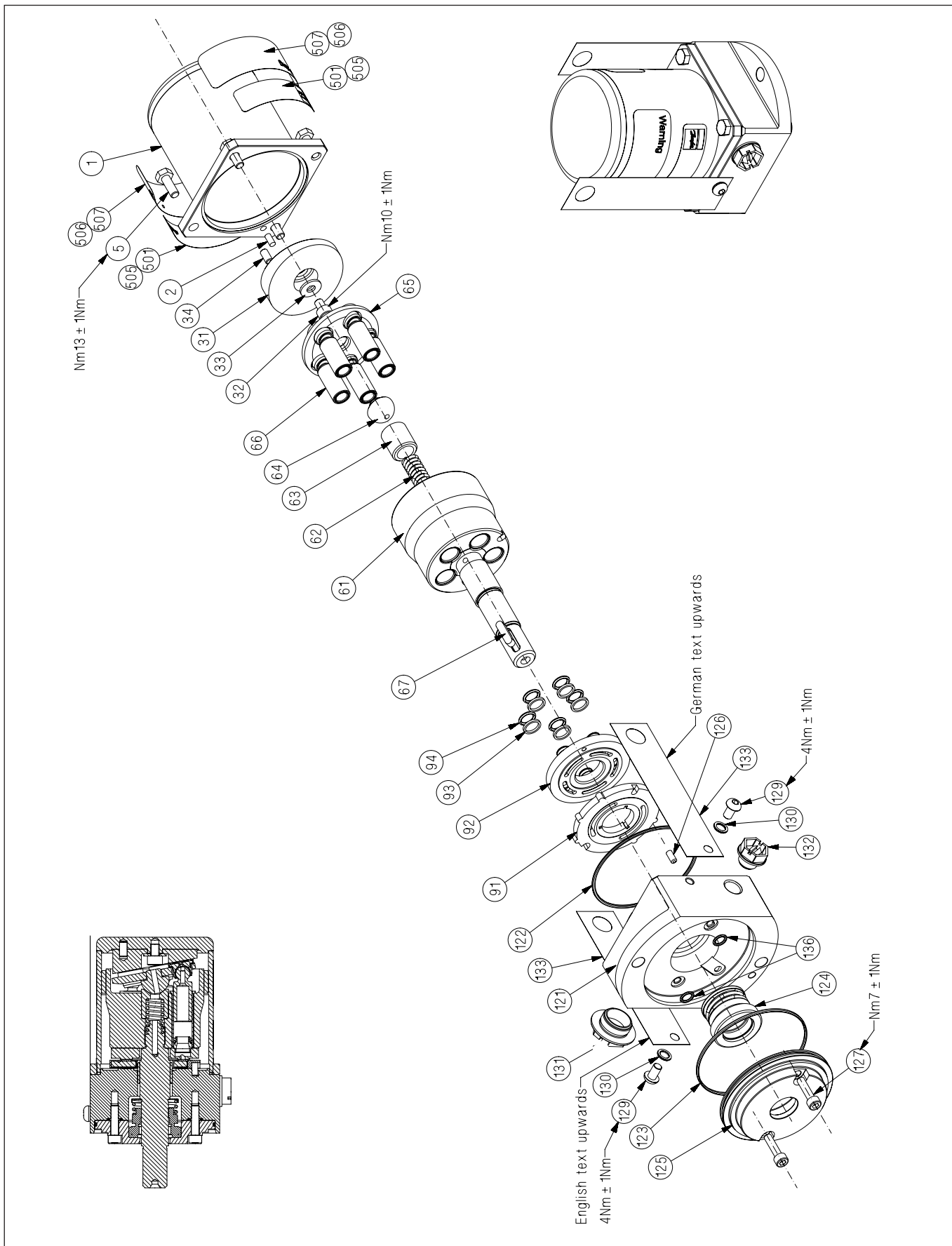

10. Spare parts list for PAHT G 3.2-6.3

Pos.	Qty.	Designation	Material	180B4307 - Seal set (PAHT G 2-6.3)	180B4311 - Cylinder barrel set (PAHT G 2-6.3)	180B4308 - Valve plate set (PAHT G 2-6.3)	180B4310 - Piston set (PAHT G 3.2-6.3)	180B4318 - Swash plate set (PAHT G 3.2)	180B4319 - Swash plate set (PAHT G 4)	180B4320 - Swash plate set (PAHT G 6.3)
1	1	Housing	AISI 304 / PEEK							
2	1	Pin Ø5 x 10	AISI 316	x						
5	4	Screw M6 x 16	AISI 316	x						
31	1	Swash plate	AISI 431					x	x	x
32	1	Screw M6 x 8	AISI 304					x	x	x
33	1	Washer	AISI 304					x	x	x
34	1	Pin Ø4 x 8	AISI 316					x	x	x
61	1	Cylinder barrel	AISI 431 / PEEK		x					
62	1	Spring	AISI 304				x			
63	1	Spring guide	PEEK				x			
64	1	Retainer ball	PEEK				x			
65	1	Retainer plate	1.4301				x			
66	5	Piston	AISI 431/ PEEK				x			
67	1	Key 5 x 5 x 20	AISI 316Ti	x						
69	1	Stop	PEEK							
91	1	Port plate	AISI 304 / PEEK			x				
92	1	Valve plate	AISI 431			x				
93	5	Back up ring	PTFE			x				
94	5	O-ring Ø8,73 x Ø1,78	NBR			x				
121	1	Port flange	AISI 304 / PEEK							
122	1	O-ring Ø70 x Ø2,72	NBR	x						
123	1	O-ring Ø75,92 x Ø1,78	NBR	x						
124	1	Shaft seal	AISI 304 / NBR	x						
125	1	End cover	AISI 304							
126	1	Pin Ø4 x 8	AISI 316							
127	2	Screw M5 x 20	AISI 304	x						
136	2	O-ring Ø7 x Ø1,5	NBR	x						
	1	Service instruction		x	x	x	x	x	x	x

11. Exploded view
PAHT G 3.2-6.3

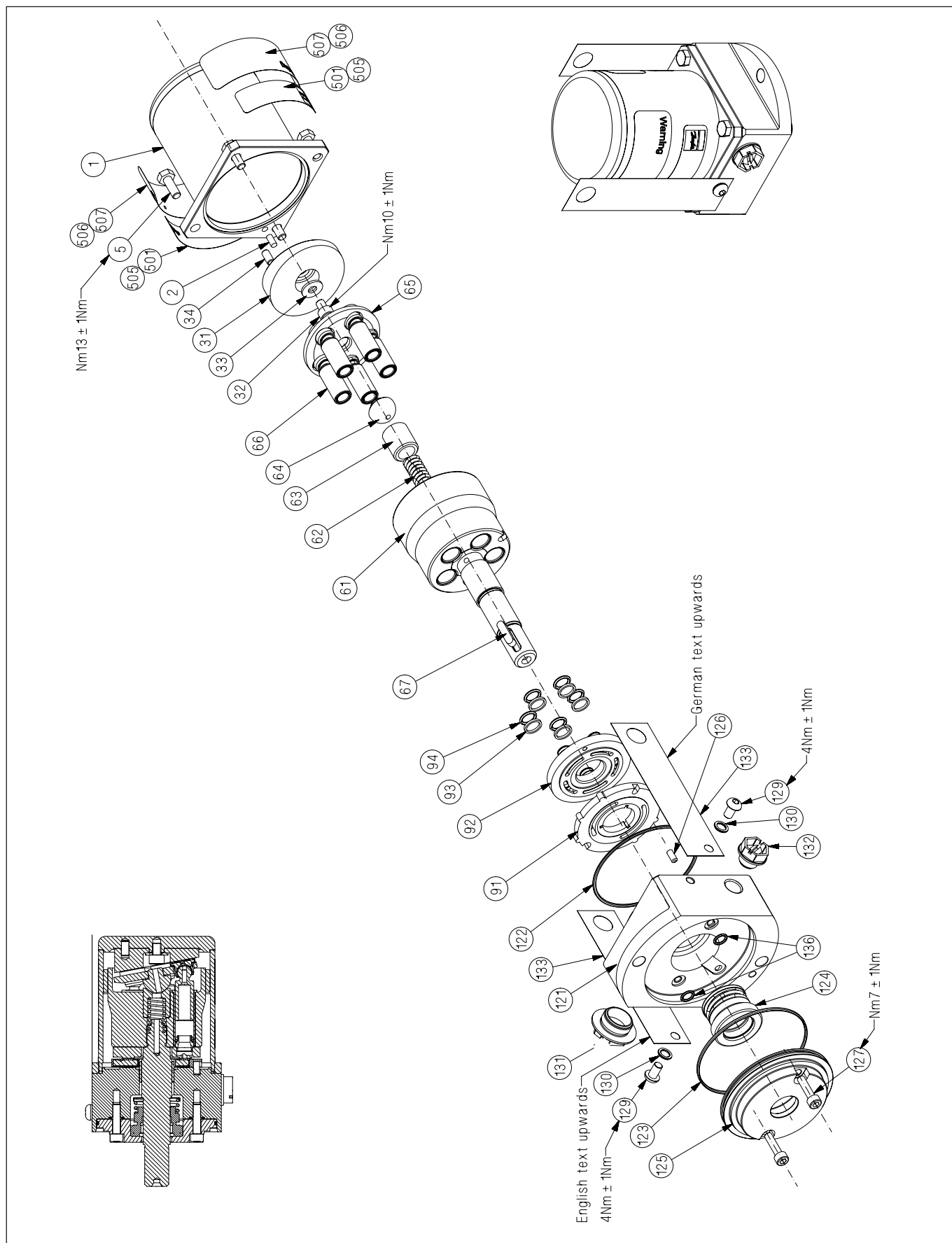

12. Tool sets

Qty.	Designation	180Z0235 - Tool set (PAH / PAHT / PAHT G 2-6.3)
1	Shaft bush, torpedo	x
1	Press bush Ø18 (Plastic)	x

Danfoss A/S
High Pressure Pumps
DK-6430 Nordborg
Denmark

Danfoss can accept no responsibility for possible errors in catalogues, brochures and other printed material. Danfoss reserves the right to alter its products without notice. This also applies to products already on order provided that such alterations can be made without subsequential changes being necessary in specifications already agreed. All trademarks in this material are property of the respective companies. Danfoss and the Danfoss logotype are trademarks of Danfoss A/S. All rights reserved.