

180R9092

180R9092

This document covers the instructions for changing internal pump elements on the axial piston pumps APP0.6-1.0

Note: It is essential that the pump is serviced in conditions of absolute cleanliness.

Tools needed:

- Shaft seal tool (code no. 180B4142)
- Seal set (code no. 180B4141)
- 2 screwdrivers

4. Carefully turn the whole pump over so that the shaft is facing down. Support the pump in a suitable hollow base so that the pump is not supported by the shaft.

To understand the pump design better, please see exploded view on last page.

1. Unscrew the 4 mounting screws and remove the seal SAE flange. **Do not yet unscrew the 2 lower screws.**

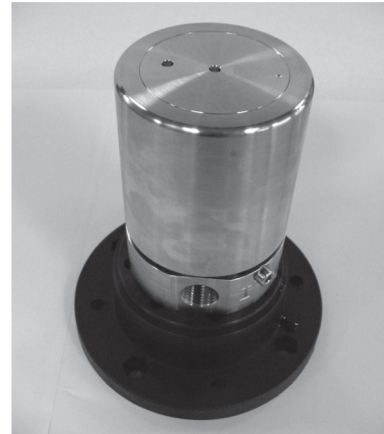
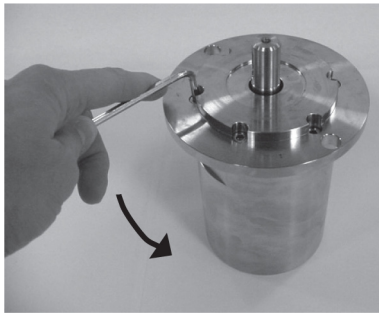

2. Wet the shaft and shaft seal with clean (filtered) soap-water. Gently lever the shaft seal assembly free using 2 screwdrivers.

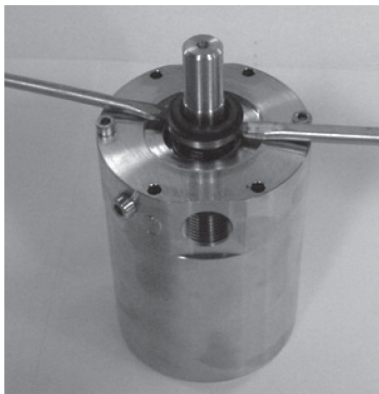

5. Remove the housing.



3. Unscrew the 2 lower screws.

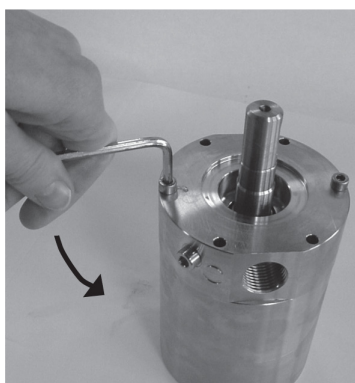

6. Remove the pistons, retaining plate, retaining ball, spring guide and spring from the cylinder barrel.

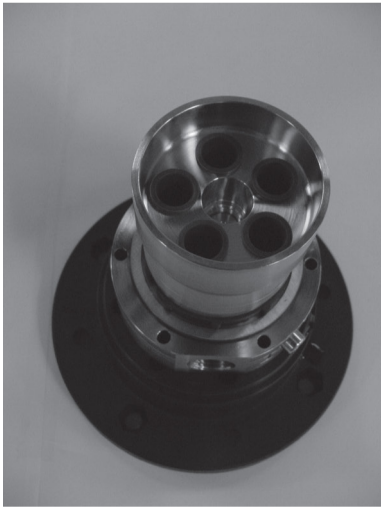

7. Remove the cylinder barrel.



8. Remove the port plate and peek pin.



9. Gently lever the valve plate assembly free with the aid of a screw-driver.

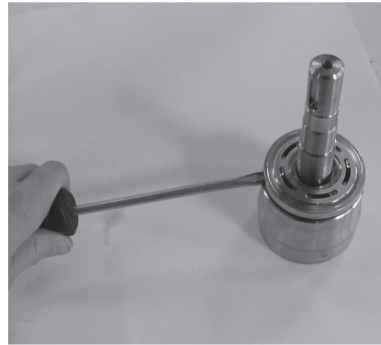

10. Replace the O-rings and the back-up rings on the valve plate. Mount the new back-up rings on the new valve plate first and then mount the new O-rings.

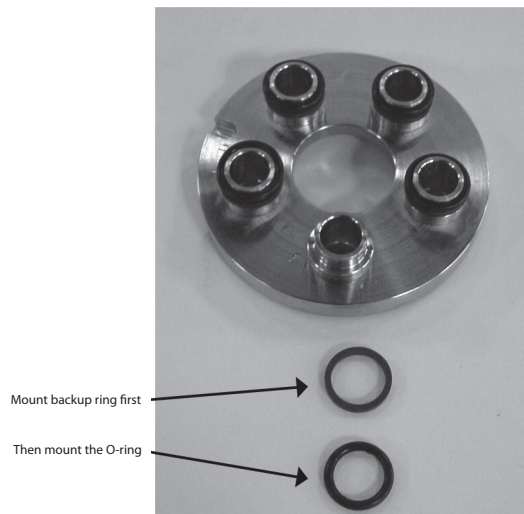

11. Wet the O-rings and back-up rings with clean (filtered) soap-water.

12. Gently press, by hand, the valve onto the cylinder barrel.



13. Position the port plate over the guide pin.
IMPORTANT: Make sure that the guide pin is located in the locating hole in the port plate.

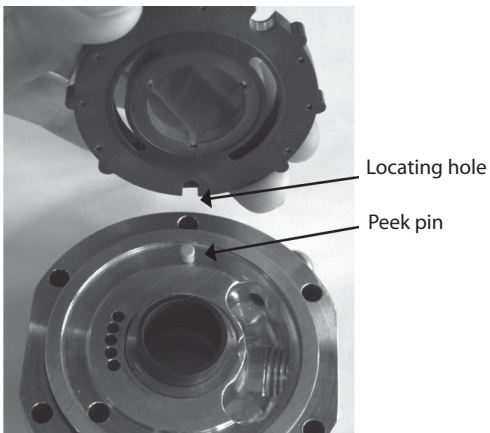

14. Replace the O-ring on the port flange and position the new cylinder barrel on the port plate.

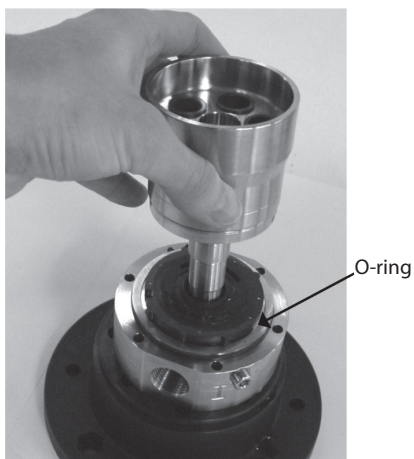

15. Position the new spring, new spring guide, new retaining ball, new retainer guide and new pistons.



16. Position the housing on the port flange and over the guide pin.



17. Hold the pump together and carefully turn it over to rest on the housing. To prevent seizing-up, lubricate the threads on the 2 screws and screw them into the port flange and the housing. Use Molykote D paste from Dow Corning or Klüber UH1 84-201 from Klüber lubrication. Tighten the 2 flange screws to a torque of 12+1Nm.

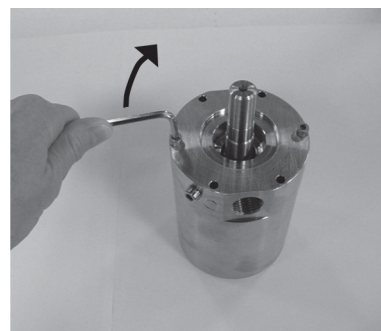

For removal of flushing valve

Tool needed: Pointed plier

18. Mount the new shaft seal following the instructions in "Shaft Seal - APP0.6-3.5" (180R9089)



19. Replace the O-ring on the SAE flange.

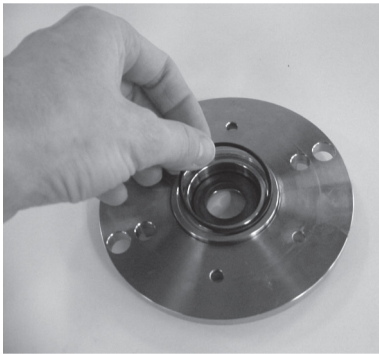

20. Lubricate the threads on the 4 screws with grease and screw them into the pump and tighten by hand. Use Molykote D paste from Dow Corning or Klüber UH1 84-201 from Klüber lubrication.

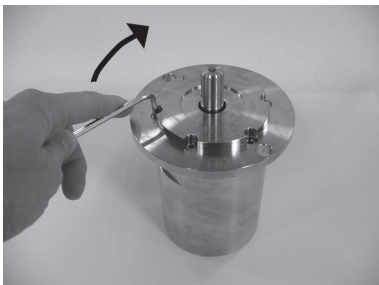

21. Tighten the screws to a torque of 12 ± 3 Nm.

1. Use a pointed plier to remove flushing valve. Gently grab the pin with the plier and pull it out.

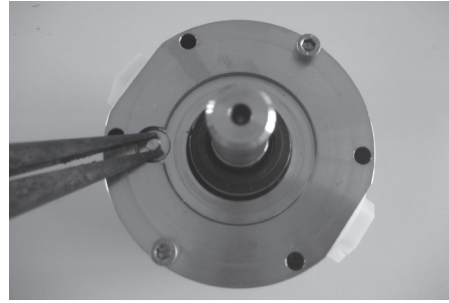

2. Assemble the new flushing valve, or replaced parts that are worn (shoulders)

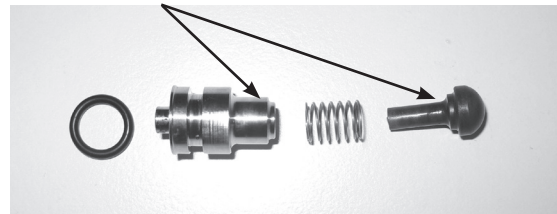

3. To assemble the valve, press new spring onto shoulders of poppet guide and poppet so it is stuck on both shoulders. Then mount the new O-ring on poppet guide.



4. Turn flushing valve upside down. If it not properly assembled, spring will fall off.

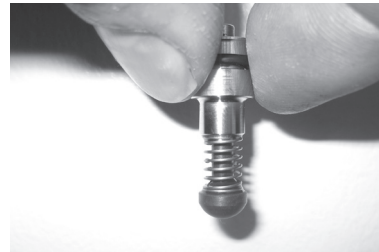

5. Mount flushing valve by pressing it into the hole.



6. It must be pressed down so it levels with the surface of the port flange (same level)

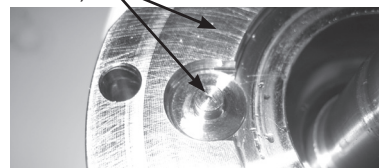

In order to find out if the valve is working correctly, the pump needs to be further dismantled. To work correctly a small flat edged wire is pushed against the flushing valve. You should be able to move it a couple of millimetres and feel the load of the spring pressing backwards.

Exploded view

