



# 1XP Series Plunger Pump

Installation, Operational and Repair Manual



Product Quality, Reliability and Support You Expect

[www.catpumps.com](http://www.catpumps.com)

# Introduction

This manual is intended to assist in installing pump and motor unit, startup and shutdown unit, troubleshoot, disassembly and reassembly of pump. An exploded view and parts list have also been provided to assist in identifying individual components, along with a torque chart.

## Table of Contents

Introduction	2
Safety	2
Important safety instructions	2
General safety information and symbols	2
Safety Hazards	3-5
Technical Features (i.e., flow, pressure, rpm, Hp)	6
Pump and motor installation (Electrical Power Connection and Plumbing Connection)	6-7
Preliminary inspection	8
Start up instructions	8
Shut down instructions	8
Preventative maintenance	8
Troubleshooting (i.e., problem – cause – solution)	8
Exploded view	9
Parts list	9
Pump disassembly	10-11
Pump reassembly	12-14
DC Motor (8136) brush replacement	15
Stopping for long periods (i.e., long term and/or winterization)	15
Restarting system	15
Torque specifications and repair tools	15

# Safety

## IMPORTANT SAFETY INSTRUCTIONS

It is the responsibility of the user to read and understand all instructions, important safeguards, and safety precautions before operating or servicing any pump. Failure to do so may result in property damage, personal injury or death.

## GENERAL SAFETY INFORMATION AND SYMBOLS

Pay special attention to the following signal words, safety alert symbols and statements:

**⚠ DANGER** Indicates a hazardous situation which, if not avoided, will result in death or serious injury.

**⚠ WARNING** Indicates a hazardous situation which, if not avoided, could result in death or serious injury.

**⚠ CAUTION** Indicates a hazardous situation which, if not avoided, could result in minor or moderate injury or property damage.

**NOTICE** Indicates a hazardous situation which, if not avoided, could result in property damage.

**⚠** Indicates a potential personal injury hazard. Obey all safety messages that follow this symbol to avoid possible injury or death.

## Safety Hazards

### **⚠ DANGER**

#### **A. FLAMMABLE OR EXPLOSIVE LIQUID HAZARD**

**Do not operate pump with flammable or explosive liquids unless extraordinary safety precautions are observed. Leaks of flammable or explosive liquids, if exposed to elevated temperatures, static electricity, sparks or other hazards, will result in flame or possible explosion, causing serious personal injury, death or property damage.**

1. Before operating pump with flammable or explosive liquids, ensure proper maintenance has been performed.
2. Do not operate pump with flammable or explosive liquids if leaks are detected.
3. Only pump flammable or explosive liquids that are compatible with pump component materials.
4. Do not operate pump with flammable or explosive liquids without safeguards or safety systems to detect leaks, elevated temperatures, spark prevention or any other hazards defined by the NFPA systems.
5. Do not remove Flammable Liquids Product Suitability Hang Tag to assure proper safety.
6. Follow ATEX guidelines for potentially explosive atmospheres.

**⚠ WARNING**

**A. ELECTRICAL SHOCK HAZARD**

**Do not service pump or electrical equipment while energized. Electricity can cause personal injury, death or property damage.**

1. Adhere to “Lock Out” and “Tag Out” procedures for electrical equipment.
2. Before commencing pump service, turn power supply off.
3. Keep water away from electrical outlets and electrical devices.
4. Electrical components must be installed by a qualified electrician to avoid risk of electrocution.

**B. ROTATING PARTS HAZARD**

**Do not service pump while energized. Moving, rotating or reciprocating parts can crush and cut, causing personal injury, death or property damage.**

1. Adhere to “Lock Out” and “Tag Out” procedures for electrical equipment.
2. Before commencing pump service, turn power supply off, turn water supply off, squeeze trigger on gun to relieve system pressure.
3. For mobile equipment, be sure engines and hydraulics are turned off and secured to avoid accidental start.
4. Do not operate with safety guards removed.
5. Always use safety guards on all belt drives, couplings and shafts.

**C. HOT SURFACE HAZARD**

**Do not touch pump, accessories or drive system while operating and until cool down is complete. Touching hot surface areas of the pump, accessories or drive system can cause severe burns or personal injury.**

**D. SKIN PUNCTURE HAZARD**

**Do not allow spray to contact any part of the body or animals. Pumped liquids under high pressure can pierce skin and underlying tissue or can deflect debris leading to serious personal injury or death.**

1. Relieve all line pressure in the inlet line to the pump and discharge line from the pump before performing any maintenance on the pump.
2. When high pressure gun is not in use, set safety trigger lock (safety latch) to avoid accidental high pressure operation and personal injury or property damage.
3. Do not check for leaks with hand. Use a piece of cardboard to check for leaks.
4. Review cleaning procedures to minimize heavy back blasting.
5. Wear adequate safety equipment and clothing when operating high pressure sprayer. Never use high pressure spray with bare feet or exposed skin, and always wear safety glasses.

**E. PUMPING LIQUIDS HAZARD**

**Do not operate pump with hot water, chemicals, or other hazardous liquids unless extraordinary safety precautions are observed. Pumping hot water, chemicals, or other hazardous liquids can expose personnel to serious injury.**

1. Provide guards or shields around equipment to protect personnel.
2. Wear mask, goggles or eye protection while operating high pressure equipment.
3. Obtain a material safety data sheet (MSDS) and take appropriate safety measures for the liquid being handled.

**F. OVER PRESSURIZATION HAZARD**

**Do not operate high pressure pumping system unless extraordinary safety precautions are observed. A high pressure pumping system can deadhead or over pressurize causing serious personal injury and property damage.**

1. All high pressure systems require a primary pressure regulating device (i.e., regulator or unloader) and a secondary pressure safety relief device (i.e., pop-off valve, safety valve, rupture disc) to assure proper pressure setting and overpressure protection.
2. All high pressure systems require a pressure gauge to monitor pressure settings and avoid overpressure of equipment or personal harm.
3. Install primary pressure relief device on the discharge side of the pump.
4. Install secondary pressure relief device between the primary device and pump.
5. Install pressure gauge onto the discharge manifold or in the discharge line near the manifold.
6. Open all valves on discharge side of plumbing before operation.

**⚠ WARNING**

Continued

**G. OXYGEN HAZARD**

**Do not charge Prrrrr-O-Lators (Pulsation Dampeners) with oxygen. Oxygen may cause an explosion causing personal injury, death or property damage.**

1. Use nitrogen only when charging pulsation dampeners, DO NOT USE OXYGEN.
2. Use proper charging tools to charge pulsation dampeners.
3. Charge pulsation dampener within specifications stated on data sheet to assure proper pulsation dampening and prevent failure of bladder.

**H. FALL HAZARD**

**Do not operate pressure washer while standing on slippery or unstable surface unless extraordinary safety precautions are observed. Pressure washing may create slippery surface on which a person may slip and fall causing personal injury or death.**

1. Wear suitable footwear to maintain a good grip on wet surfaces.
2. Do not stand on ladders or scaffolding.
3. Do not over reach or stand on unstable supports.
4. Keep good footing and balance and hold gun with both hands to control kick back.

**⚠ CAUTION****A. IMPROPER USE OF FITTINGS HAZARD**

**Do not operate the pump with improperly connected, sized, worn or loose fittings, pipes or hoses. Operating the pump under these conditions could result in personal injury and property damage.**

1. Ensure all fittings, pipes and hoses are properly rated for the maximum pressure rating and flow of the pump.
2. Check all fittings and pipes for cracks or damaged threads.
3. Check all hoses for cuts, wear, leaks, kinks or collapse before each use.
4. Ensure all connections are tight and secure.
5. Use PTFE thread tape or pipe thread sealant (sparingly) to reconnect plumbing. Do not wrap tape beyond the last thread, this will prevent tape from becoming lodged in the pump or accessories.
6. Apply proper sealants to assure secure fit or easy disassembly when servicing.

**B. FROZEN LIQUID HAZARD**

**Do not operate the pump with frozen liquid. Operating the pump under this condition could over pressurize and jettison the manifold from the crankcase causing personal injury and property damage.**

1. Store pump or pumping system in an environmentally controlled room protected from freezing temperatures.
2. Follow procedures in TECH BULLETIN 083 to winterize pump.

**C. CLEANING PUMP HAZARD**

**Do not use solvents that are flammable and toxic to clean or degrease equipment. Use of these solvents could result in personal injury and property damage.**

1. Follow safety instructions as found in MSDS or on packaging of each liquid.
2. Clean equipment in a well ventilated area.
3. Disposal of solvents to be in accordance with local, state and federal regulations.

**D. OPERATING BEYOND SPECIFICATIONS HAZARD**

**Do not operate the pump outside the specifications of individual pump data sheet or service manual. Operating the pump under these conditions could result in personal injury and property damage.**

1. Do not operate the pump faster than the maximum recommended RPM.
2. Do not operate the pump at pressures higher than the maximum recommended pressure.
3. Do not operate the pump at temperatures higher than the maximum recommended temperatures.
4. Do not use accessories that are not compatible or rated for the pump.

**CAUTION**

Continued

**E. LIFTING DEVICE HAZARD**

**Do not lift pump with unsuitable lifting devices. Use of unsuitable lifting devices may cause pump to fall resulting in personal injury, damage to pump and/or pump with drive/base plate.**

1. Lifting eyes installed on the pump must be used only to lift the pump.
2. Special lifting eyes should be installed on the base for lifting the pumping system (i.e. base, drive and accessories)
3. If slings or chains are used for lifting, they must be safely and securely attached to properly balance the weight of the unit.
4. Inspect slings and chains prior to use and replace worn and damaged slings and chains.

**NOTICE****A. ROTATION OF PUMP HAZARD**

**Do not rotate pump crankshaft in reverse direction. Rotation of pump crankshaft in reverse direction may not provide proper lubrication and may result in damage to the drive-end components.**

1. Forward rotation is the top of the crankshaft turning towards the manifold head of the pump.
2. Ensure oil is filled to the center red dot on sight gauge for forward rotation.
3. Ensure oil is filled to slightly above center red dot on sight gauge for reverse rotation.

**B. BELT TENSION HAZARD**

**Do not operate pump with excessive belt tension. Excessive belt tension may damage the pumps bearings or reduce horsepower.**

1. Rotate pump crankshaft before starting to ensure shaft and bearings are moving freely.
2. Ensure pulleys are properly sized.
3. Periodically replace belts to assure full horsepower transmission.
4. Ensure center distance dimensions between pulleys is correct.

**C. BY-PASS OPERATION HAZARD**

**Do not operate the pump in by-pass for extended lengths of time. Operating the pump under this condition can quickly cause heat build-up resulting in damage to the pump.**

1. Route by-pass line to supply reservoir to dissipate heated by-pass liquid into a large reservoir of cool water to reduce excessive temperature build-up.
2. Route by-pass line to inlet of pump using a thermo valve in the by-pass line or auto shut-off assembly that will sense temperature rise and either by-pass or shut down system before damage occurs.

**D. DRY OPERATION HAZARD**

**Do not operate the pump without water or liquid. Operating pump under these conditions could result in damage to the pump.**

1. Open all valves on inlet side of pump before starting operation to prevent starving the pump.
2. Do not exceed inlet suction pressure limit specified in pump Data Sheet.
3. Ensure inlet feed exceeds the maximum flow being delivered by the pump.
4. Ensure all fittings, pipes and hoses are properly sized for the pump to avoid restricted flow.
5. Review and implement all other recommendations appropriate for your system from the Inlet Condition Check-List.

# Technical features

There are seven (7) cams available for the 1XP Series Pumps. Each cam is numbered from 1 to 7, with the smallest number 1 indicating the lowest flow starting at 0.50 gpm, up to the largest number 7 indicating 2.00 gpm. If a label has been removed or destroyed, simply remove bearing cover and check stamped number on cam. Use chart to verify which stamped number applies to your model of pump. Each pump model number also helps identify the flow of your pump, See chart below.

Pump Model	Cam ID number
1XP050	1
1XP075	2
1XP085	3
1XP100	4
1XP125	5
1XP150	6
1XP200	7

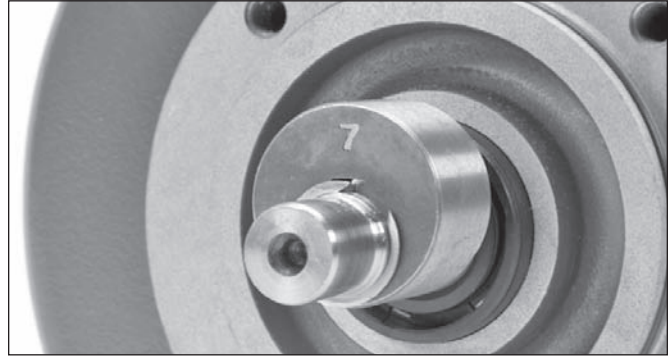

Stamped Cam ID number (See Chart)

# Pump and motor installation

Due to the variety and uniqueness of each extractor machine that is available, there is no one sure way of installing the 1XP motorized pump unit. Please read and follow existing extractor operational manual when removing pump and motor from machine. Follow all safety instructions. Use the following steps to properly wire and plumb the new 1XP series pumps.

- 1.1 Position assembled pump and motor (AC or DC) into extractor machine.
- 1.2 Secure assembled unit to extractor base using hole pattern of motor.

# Electrical power connection:

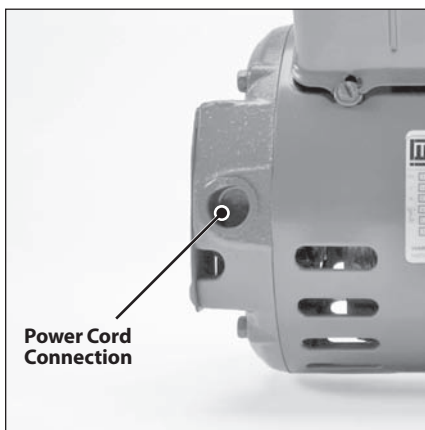

- 1.3 Connect to power source for AC (induction) motors 8133, 8135 and 8137 (115/208-230VAC).



- 1.4 Connect to power source for DC (permanent magnet) motor 8136 (120 Volt - rectified).

# Plumbing connection:

**NOTE:** Standard pump to motor mounting is shown in figure 1.5 (inlet port facing out). Figures 1.6, 1.7 and 1.8 are optional ways of mounting pump to motor.

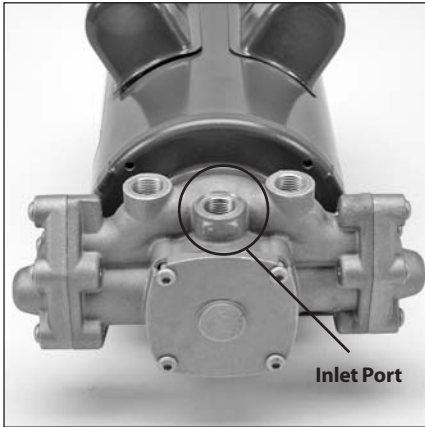

1.5 Install inlet water hose to center 3/8" NPT port on pump labeled "INLET"



1.6 Pump inlet port facing motor.



1.7 Pump inlet port rotated 90° counter-clockwise in a vertical position.



1.8 Pump inlet port rotated 90° clockwise in a vertical position.

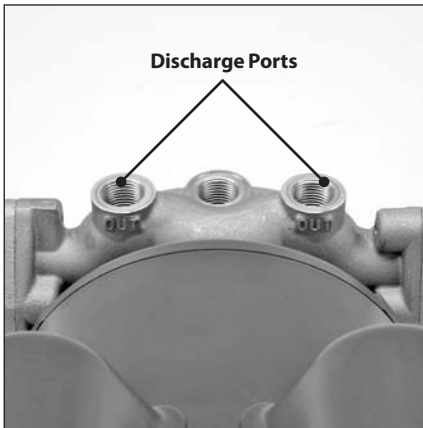

1.9 Install discharge accessories or water hoses to two (2) 3/8" NPT ports labeled "OUT"

# Preliminary inspection

After inlet hose, discharge hose and/or accessories have been installed to ports of pump crankcase follow the preliminary steps as outlined below prior to startup.

- 2.1 Ensure all hoses and fittings are tight.
- 2.2 Ensure water is supplied to the pump before starting.
- 2.3 Ensure regulating device is set or backed off to the lowest setting.
- 2.4 Ensure there is power to the motor.
- 2.5 Ensure there is water in supply tank of extractor machine.

# Start up instructions

The 1XP pump requires a gravity fed inlet, and can be used on pressurized inlets up to 40 psi. Do not starve the pump or run the pump dry. **Note:** AMP draw will be elevated during 1st hour of operation. After 1.0 hour, AMP draw will drop by 10%. Follow the steps as outlined to ensure properly operation.

- 3.1 Turn on water supply to the pump.
- 3.2 Turn on power to pump.
- 3.3 Open discharge to atmosphere to purge air from system.
- 3.4 Adjust regulating device to desired pressure.

# Shut down instructions

To stop the pump in an emergency, turn off power to pump and relieve all line pressures by triggering gun handle. Under normal conditions follow the steps as outlined below.

- 4.1 Turn off power to pump.
- 4.2 Turn off water supply to pump.
- 4.3 Squeeze and hold trigger gun to relieve discharge line pressure.

# Preventative maintenance

Periodic maintenance and adjustment is necessary to keep the pump in good operating condition. Perform the service and inspection scheduled in the table. Use only genuine Cat Pumps parts or kits when performing repairs.

Check	Daily	Weekly	600 Hours	1000 Hours
Water leaks	x			
Plumbing		x		
Seal change				x
Inlet valve change				x
Discharge valve change				x
Brushes (8136 Motor)			x	

# Troubleshooting

The troubleshooting table has been provided to assist in defining problems that may arise, then giving probable causes to look for and finally providing possible solutions to the problem at hand.

Problem:	Probable Causes:	Solutions:
Low pressure	Worn nozzle	Replace with proper size nozzle
	Worn seals	Install new seal kit. Increase frequency of service
	Air leak in inlet plumbing	Tighten fittings and hoses. Use PTFE liquid or tape
	Worn or dirty inlet/discharge valve	Clean inlet/discharge valves or install new valve kit.
Water leak at head cover	Worn or pinched o-ring on head cover.	Install new seal kit. Increase frequency of service.
Water leak at bearing cover	Worn or pinched o-ring on bearing cover	Install new seal kit. Increase frequency of service
Premature seal failure	Running dry, scored plungers, abrasives, contamination	Replace seals
Scored plunger	Abrasives, contamination	Replace plunger
Motor stalls or will not start	Brushes worn	Replace with Brush Repair Kit



# Exploded view

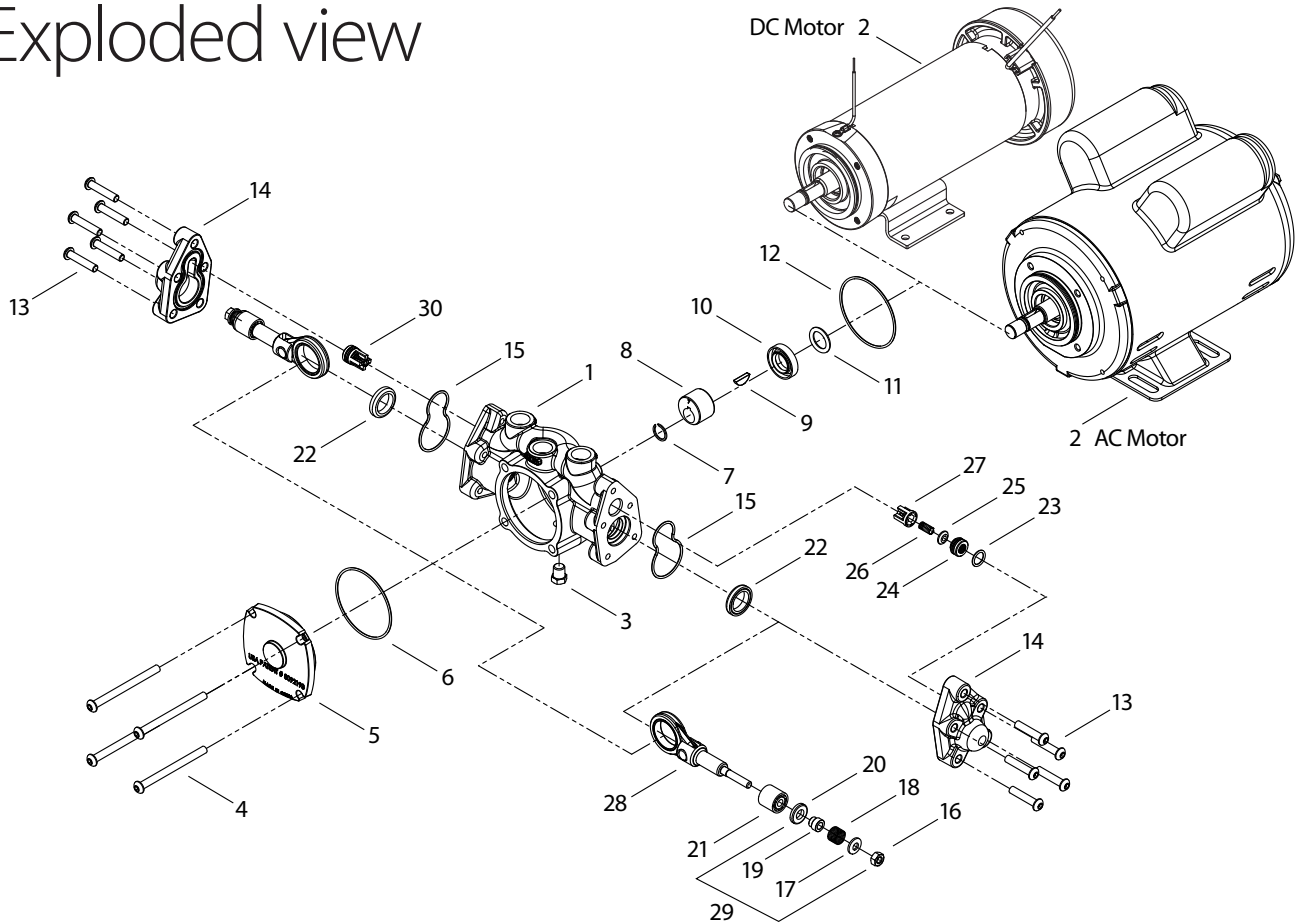

Item No.	Part Number	Material	Description	Qty
1	76801	AL	Crankcase	1
2	8133	-	Motor, 1/3 HP (AC)	1
	8135	-	Motor, 1/2 HP (AC)	1
	8137	-	Motor, 3/4 HP (AC)	1
	8136	-	Motor, 1/3 HP (DC)	1
3	31527	BB	Plug (1/8"- 27NPT)	1
4	76928	STZP	Screw, Button Head (M6 X 75)	4
5	76346	AL	Cover, Bearing	1
6	31552	FPM	O-ring, Bearing Cover - 70D	1
7	76701	S	Ring, External Retaining	1
8	76520.050	SFSS	#1 Cam (0.50 gpm, 1750 rpm)	1
	76520.075	SFSS	#2 Cam (0.75 gpm, 1750 rpm)	1
	76520.085	SFSS	#3 Cam (0.85 gpm, 1750 rpm)	1
	76520.100	SFSS	#4 Cam (1.00 gpm, 1750 rpm)	1
	76520.125	SFSS	#5 Cam (1.25 gpm, 1750 rpm)	1
	76520.150	SFSS	#6 Cam (1.50 gpm, 1750 rpm)	1
76520.200	SFSS	#7 Cam (2.00 gpm, 1750 rpm)	1	
9	76025	SFSS	Key, Woodruff (#405)	1
10	76030	FPM	Seal, Shaft	1
11	31596	FPM	O-ring, Slinger - 70D	1
12	31552	FPM	O-Ring, Motor Flange	1
13	76929	STZP	Screw, (M6 X 30)	10
	76909*	STZP	Screw, (HSH) (M6 X 30)	10
14	76420	AL	Cover, Head	2

Item No.	Part Number	Material	Description	Qty
15	31592	FPM	O-ring, Head Gasket - 70D	2
16	31577	S	Nut (M6)	2
17	31584	S	Washer, Conical (M6)	2
18	44872	S	Spring	2
19	31595	S	Spacer	2
20	76226	NY	Valve, Inlet	2
21	45429	CC	Plunger (M18 X 16)	2
22	43245	SNG	Seal, High Pressure W/Spring	2
23	35426	FPM	O-ring, Valve Seat - 90D	2
24	76216	S	Seat, Discharge Valve	2
25	76206	S	Valve, Discharge	2
26	46865	S	Spring, Valve	2
27	76069	PVDF	Retainer, Valve	2
28	76555	AL	Assembly, Plunger/Connecting Rod (Includes: plunger rod, connecting rod & wrist pin)	1
29	76227	NY	Kit, Inlet Valve (Includes: items 16, 17, 18, 19, 20)	1
30	76218	FPM	Assembly, Valve (Includes: items 23, 24, 25, 26, 27)	1
31	76219	FPM	Kit, Seal and O-ring (Includes: items 6, 10, 11, 12, 15, 22)	1
32	76127	-	Kit, Brush Replacement	1

AL = Aluminum, BB = Brass, CC = Ceramic, FPM = Fluorocarbon, NY = Nylon, PVDF = Polyvinylidene Fluoride, S = 304 Stainless Steel, SFSS = 17-4 Stainless Steel, SNG = Special Blend (Buna), STZP = Steel/Zinc Plated. \* Use only on models rated for 1000 psi

# Pump disassembly

**⚠ WARNING**

**Do not service pump or electrical equipment while energized.**

**Electricity can cause personal injury, death or property damage.**

1. Adhere to "Lock Out" and "Tag Out" procedures for electrical equipment.
2. Before commencing pump service, turn power supply off.
3. Keep water away from electrical outlets and electrical devices.
4. Electrical components must be installed by a qualified electrician to avoid risk of electrocution.

**NOTE:** Numbers in ( ) refer to item numbers in exploded view.



5.1 Disconnect plumbing and wiring to motor. Remove pump and motor assembly from machine.



5.2 Remove brass drain plug (3) from pump crankcase (1) to drain water.

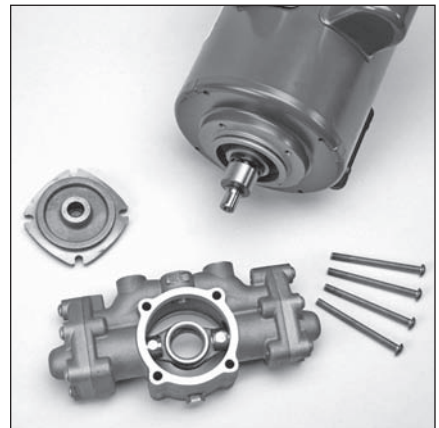

5.3 Separate pump (1) from motor (2) by removing four (4) M6x75 button head screws (4) from bearing cover (5).

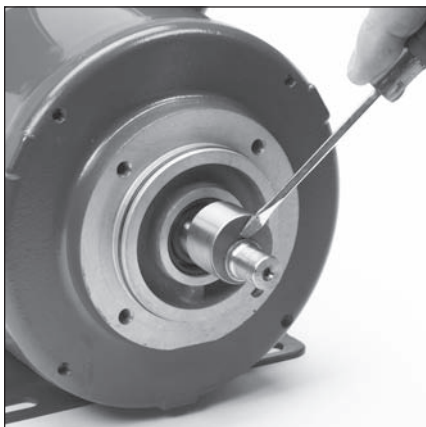

5.4 Remove and inspect retaining ring (7) from motor shaft.



5.5 Remove and inspect cam (8) from motor shaft.



5.6 Remove and inspect woodruff key (9) from keyway of motor shaft.



5.7 Remove and inspect shaft seal (10) from motor flange. Do not scratch or damage motor shaft surface. (See Note)



5.8 Remove and inspect slinger o-ring (11) from motor flange.



5.9 Remove five (5) M6x30 screws (13) holding head cover (14) to crankcase body.

**NOTE:** If shaft seal cannot be removed, it may require removing motor end cover. See Tech Bulletin #117.

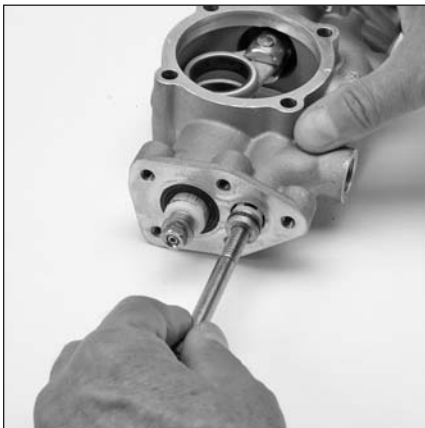

5.10 Remove discharge valve assembly by using M8 threaded bolt.



5.11 Thread M8 bolt so it makes contact with valve, continue threading until separation of retainer and seat.



5.12 Separate and inspect retainer (27), spring (26), valve (25), seat (24), and o-ring (23).

**NOTE:** Inlet valve, discharge valve, high pressure seal and plunger are identical in both cylinder heads.



5.13 Remove and inspect nut (16), washer (17), spacer (19), spring (18) and inlet valve (20).



5.14 Remove and inspect ceramic plunger (21) and high pressure seal (22) from crankcase body (1).

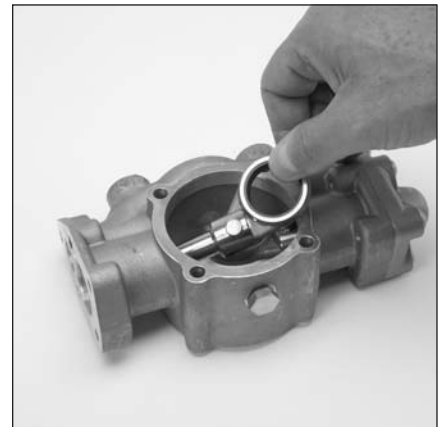

5.15 Remove and inspect connecting rod, plunger rod and wrist pin assembly.

# Pump reassembly



6.1 Lubricate and install slinger o-ring (11) onto motor flange by sliding over motor shaft. Center between shaft seal bore and back of the slinger seal bore.



6.2 Lubricate and install shaft seal (10) onto motor flange with spring of seal facing pump.



6.3 Lubricate and install o-ring (12) onto motor flange.



6.4 Lubricate and install woodruff key (9) into motor shaft keyway.



6.5 Lubricate and install cam (8) over motor shaft and key. Position cam (8) so stamped cam ID number is facing pump.



6.6 Install retaining ring (7) into snap ring groove on motor shaft to secure cam (8).



6.7 Lubricate and install o-ring (6) onto bearing cover (5).



6.8 Install plunger rod/connecting rod assembly through large opening in crankcase body (1).

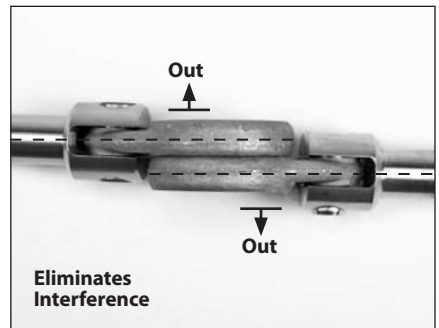

6.9 Protruding cast face of connecting rods should face away from each other inside crankcase (1).

## NOTICE

Be careful not to damage the bushing ID in the case, as the plunger rod thread passes through the bushing.



6.10 Assemble the discharge valve as follows: Insert spring (26) into retainer (27).

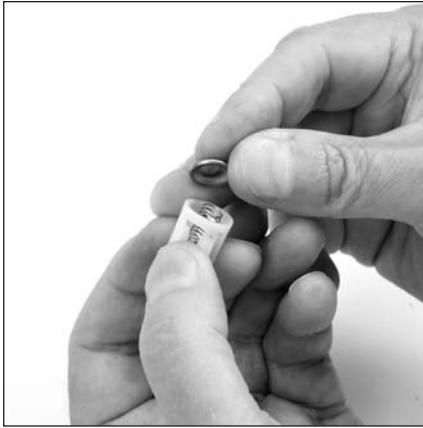

6.11 Place valve (25) cupped side over the spring (26).



6.12 Place tapered side of seat (24) towards retainer (27) and snap into place.



6.13 Lubricate and install o-ring (23) to seat (24). Repeat for second valve assembly.



6.14 Press discharge valve assembly (30) into top hole with retainer facing into crankcase body (1) until flush with cylinder head surface.



6.15 Install ceramic plunger (21) with larger ID over plunger rod threads. Ceramic plunger can only be installed one way.



6.16 Lightly lubricate and install high pressure seal (22) with metal backing facing down over ceramic plunger (21).



6.17 Install inlet valve (20) with flat side down onto plunger (21).



6.18 Install spacer (19) small diameter down into inlet valve (20).



6.19 Install spring (18) over spacer (19) and on to inlet valve (20).

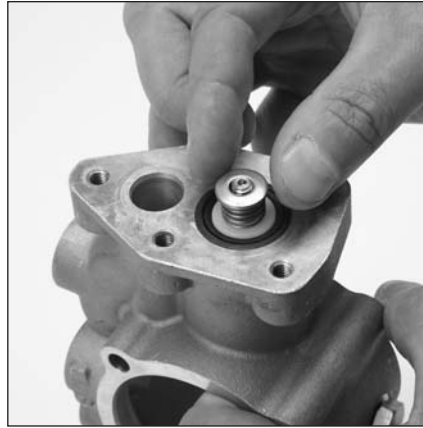

6.20 Install washer (17) with curved surface down on to spring (18).



6.21 Apply Loctite®242® to M6 threads on plunger rod. Thread nut (16) onto M6 threads of plunger rod and torque to 25 in-lbs.



6.22 Lubricate and install o-ring (15) into head cover. Repeat for other cylinder head.

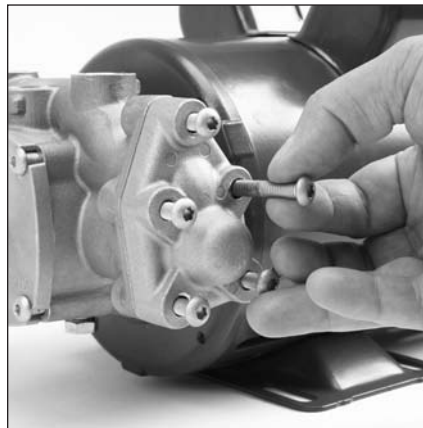

6.23 Position head cover (14) onto crankcase body (1) and hand thread in five (5) M6x30 screws (13).

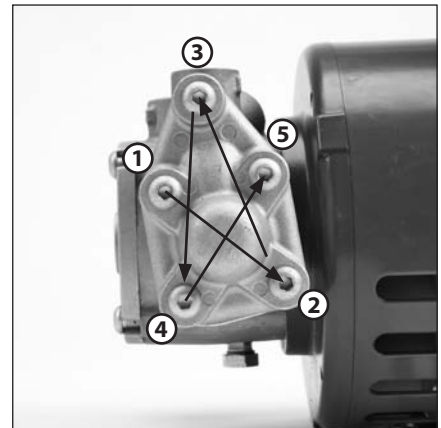

6.24 Torque to 102 in-lbs in sequence as shown.

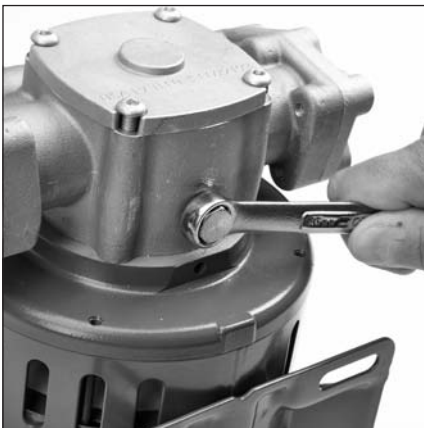

6.25 Install drain plug (3) into bottom port of crankcase body (1).

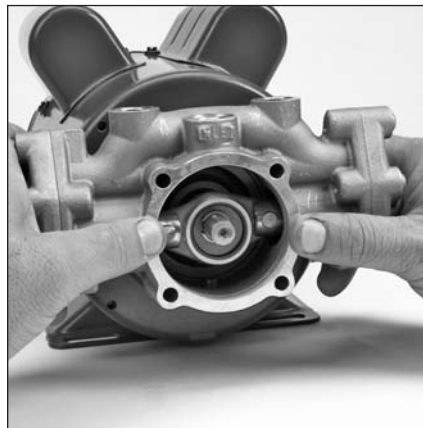

6.26 With bearing cover (5) removed, position crankcase body (1) onto motor while lining up the connecting rods (28) with the cam (8).

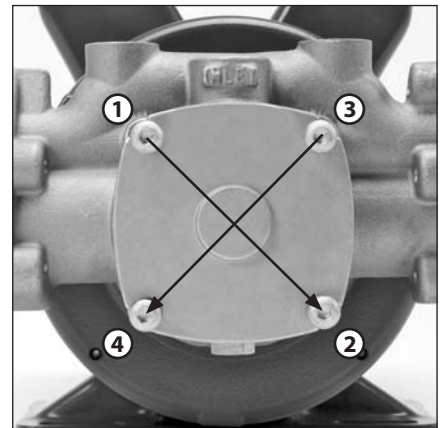

6.27 Hand thread four (4) M6x75 button head screws (4). Torque to 48 in-lbs in sequence as shown. **Note:** Lubricate o-ring on bearing cover prior to installing.

# DC Motor (8136) Brush Replacement



## DISASSEMBLY

- 7.1 Place flat tip of screwdriver between the top of the white retaining clip and end cover and pry upwards to provide small separation between cover and motor housing.
- 7.2 Using same screwdriver, remove white retaining clip.
- 7.3 Remove wire lead from small opening in motor housing.
- 7.4 Blow out dust that may accumulate in opening of motor.
- 7.5 Repeat steps 7.1 to 7.4 to remove second wire lead.

## REASSEMBLY

- 7.6 Position wire lead into opening of motor with brush and attaching spring down into opening with brass end facing up.
- 7.7 Place white retaining clip over wire lead and snap into place.
- 7.8 Using a soft mallet, tap end of cover until place.
- 7.9 Repeat steps 7.6 to 7.8 to reassemble second wire lead.

## Stopping for long periods

If the extractor unit will not be operated for a long period of time or needs to be placed in storage, please follow these steps to protect the pump.

- 8.1 Flush pump with fresh water.
- 8.2 Turn off power supply.
- 8.3 Squeeze trigger gun to relieve discharge line pressure.
- 8.4 Disconnect inlet and discharge plumbing.
- 8.5 Connect a short 4 foot hose to the pump inlet and place the other end of the hose in a container with 50% water and 50% antifreeze.
- 8.6 Start the unit and run until the antifreeze flows out the discharge of the pump.
- 8.7 Shut the unit off and disconnect the hose from the pump inlet.
- 8.8 Store unit (do not install plugs in the inlet and discharge ports).

## Restarting System

If the extractor unit has been shut down for any length of time, the following steps should be used as a guideline to ensure the proper restarting and resetting of the pump.

- 9.1 Turn regulator/unloader setting to lowest pressure point.
- 9.2 Reconnect the liquid supply line, discharge line and allow liquid to flow through pump for 2-3 minutes.
- 9.3 Check for leaks at all plumbing connections.
- 9.4 Gradually reset regulator/unloader in small increments to desired system pressure and resume operation.
- 9.5 Follow your established maintenance cycle or the standard Preventative Maintenance checklist in this manual.

## Torque specifications and repair tools

Torque values (in-lbs) and sequences are referenced in each section as it applies. This chart provides the same values, but also expands to "ft-lbs" and "Nm", as well as supplies thread sizes and tools required.

Item	Thread	Tool Size	in - lbs	Torque	
				ft - lbs	N - m
Bearing cover screws	M6	M4 Allen	48	4.00	5.20
Head cover screws	M6	M4 Allen	102	8.50	11.05
Inlet valve nut	M6	M10 Hex	25	2.08	2.70
Drain plug	1/8" - 27 NPT	M13 Hex	"Water tight seal"	-	-



**CAT PUMPS**

1681 - 94TH LANE N.E. MINNEAPOLIS, MN 55449-4324  
PHONE (763) 780-5440 — FAX (763) 780-2958  
e-mail: [techsupport@catpumps.com](mailto:techsupport@catpumps.com)  
[www.catpumps.com](http://www.catpumps.com)

For International Inquiries go to [www.catpumps.com](http://www.catpumps.com) and navigate to the “Contact Us” link.