

Close Coupled Centrifugal Pumps

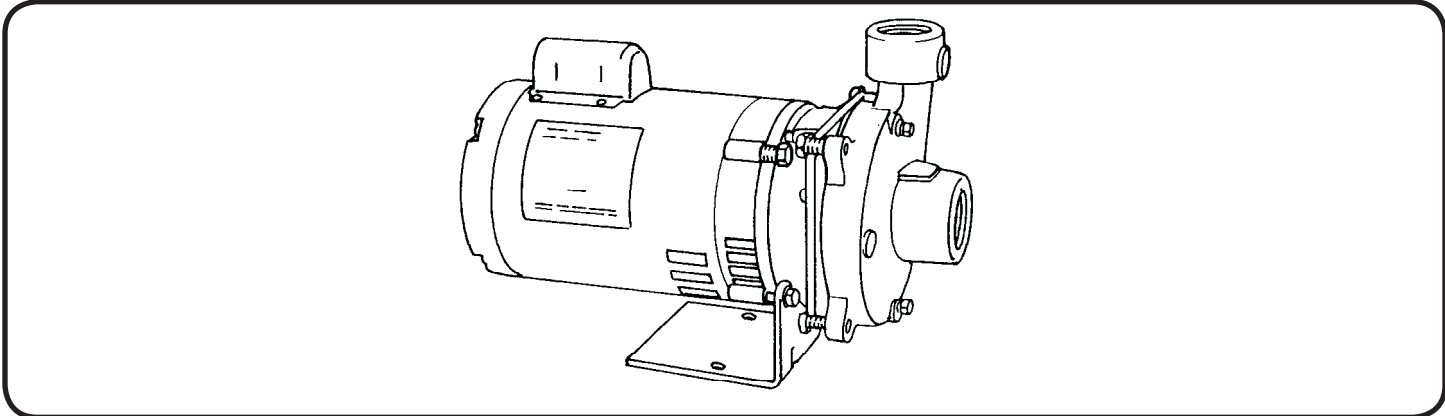

3500 RPM - 60Hz.
CAPACITIES TO 100 GPM (6.3 LPS)
HEADS TO 130 FEET (39.6 M)

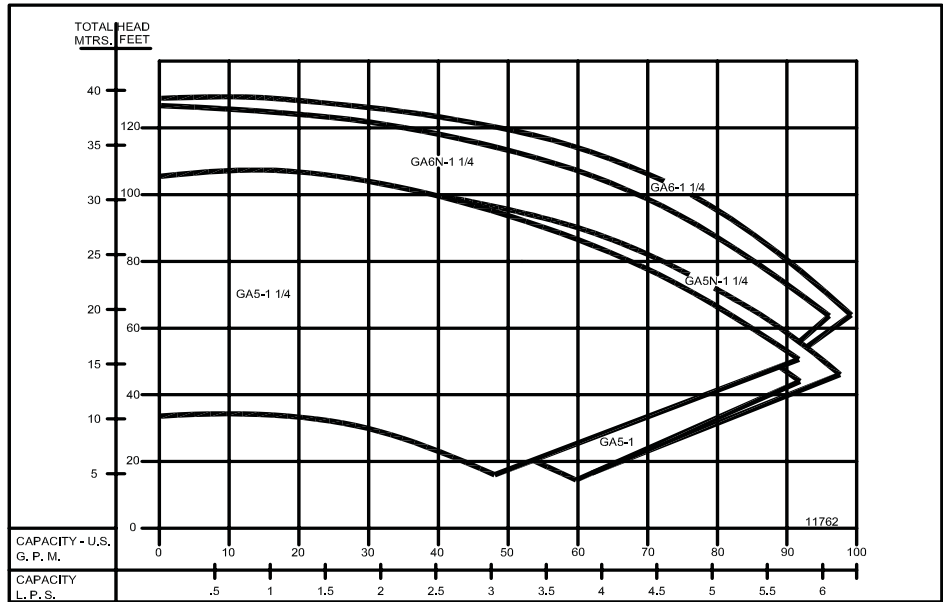

2900 RPM - 50Hz.
CAPACITIES TO 83 GPM (5.2 LPS)
HEADS TO 89 FEET (27 M)

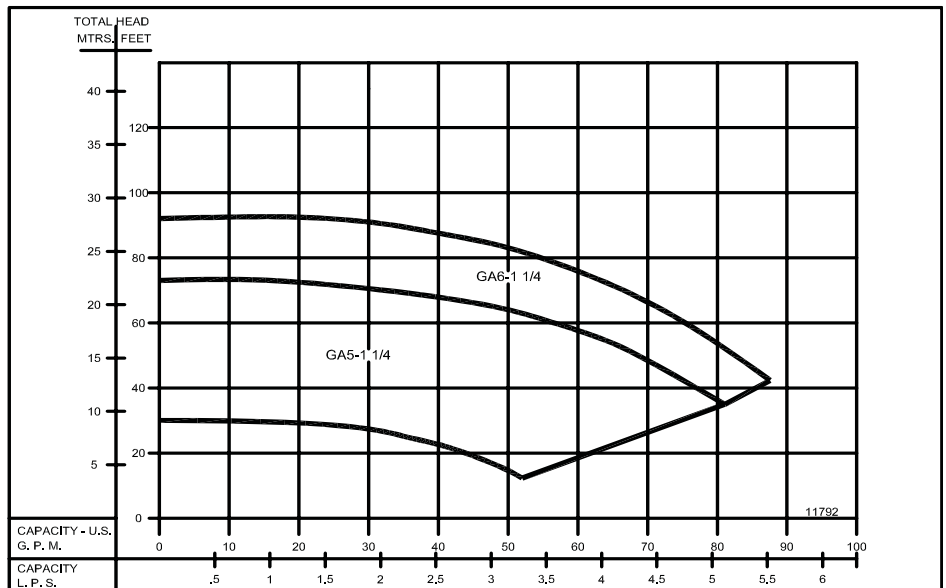

Individual performance curve should be checked for final selection.

Close Coupled Centrifugal Pumps

FOUR POSITION CASING

Discharge can be located in any of four positions. Casing is close grain iron of 30,000 psi minimum tensile strength. Back pull-out design eliminates the need to disturb piping should the pump ever require service - the casing stays in the line.

ENCLOSED BRONZE IMPELLER

Of the latest hydraulic design for maximum efficiency, impeller is balanced for vibration-free operation and threaded onto stainless steel motor shaft.

ENCLOSED GLASS FILLED NORYL® IMPELLER*

Of the latest hydraulic design for maximum efficiency, impeller has molded in brass insert threaded onto stainless steel motor shaft. *Noryl® Impeller is not designed for use with hydrocarbons.

MECHANICAL SHAFT SEAL

Standard self-adjusting shaft seal for temperatures to 225°F (107°C) and pressures to 150 psi (1034 kpa). Ceramic seat and carbon seal face for long trouble-free service. Special seals are available for higher temperatures and fluids other than water.

MOTORS

Standard pump motors are of open drip proof (ODP) construction and are rated with jet pump service factors for continuous duty operation. Motors are 56 frame size with NEMA standard mounting flange, one piece threaded stainless steel shaft and ball/ball bearing construction.

FACTORY TESTED

After careful assembly and inspection, EVERY pump is factory tested and meets Hydraulic Institute standards.

MAXIMUM OPERATING CONDITIONS

TEMPERATURE (For Standard Buna-N Seal)	225°F (107°C) BRONZE	175°F (79°C) NORYL®
INLET PRESSURE	70 PSI (433kPa)	
CASING WORKING PRESSURE	200 PSI (1379kPa)	

MOTOR INFORMATION

60 Hz - 3500 RPM - ODP

Single Phase: 1/3 thru 2 Hp. - 115/230 Volt

3 Hp. - 230 Volt only

Three Phase: 1/3 thru 3 Hp. - 208-230/460 Volt

50 Hz - 2900 RPM - ODP

Single Phase: 110/220 Volt

Three Phase: 380 Volt

Voltages may differ from some suppliers. Consult factory. Overload Protection: All single phase ODP and Totally Enclosed motors have built-in overload protection. All three phase motors and all explosion proof motors must be installed with a magnetic starter which provides full 3-leg protection. Failure to use correct starter and overloads will void motor warranty.

JACKETED SEAL CAVITY FOR TEMPERATURES TO 500°F (260°C).

Series GA5-1 & GA5-11/4 Pumps are available in a Jacketed Seal Cavity design for pumping hot oil, hot water and heat transfer fluids in common use in high temperature heating or cooling applications. This feature greatly extends seal life in high temperature applications. To order, add suffix "MJ" to pump catalog number for temperatures to 500°F (260°C) See Section on High Temperature Pumps for more information.

MATERIALS OF CONSTRUCTION

PART	ALL IRON	BRONZE FITTED	ALL BRONZE	NORYL® FITTED
Adapter	Cast Iron	Cast Iron	Bronze	Cast Iron
Casing	Cast Iron	Cast Iron	Bronze	Cast Iron
Impeller	Cast Iron	Bronze	Bronze	Glass Filled Noryl
Shaft	#303 Stainless	#303 Stainless	#303 Stainless	#303 Stainless
Shaft Seal	Carbon-Ceramic SS - Buna-N	Carbon-Ceramic SS - Buna-N	Carbon-Ceramic SS - Buna-N	Carbon-Ceramic SS - Buna-N

Close Coupled Centrifugal Pumps

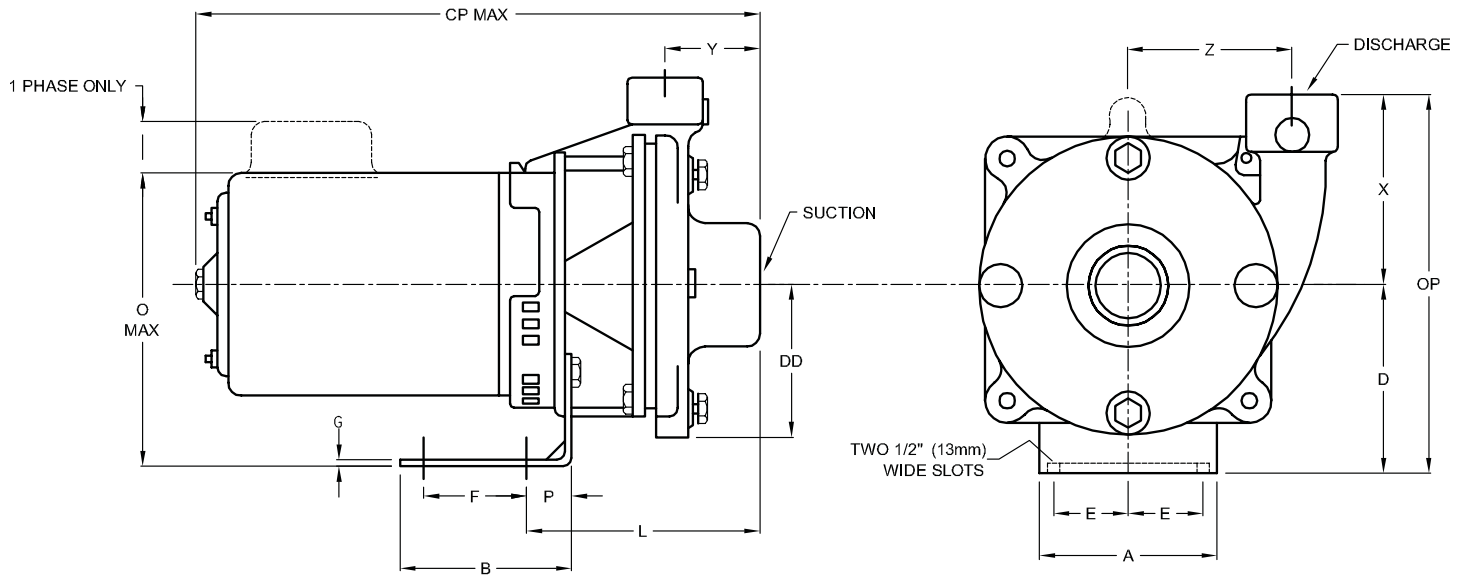

DIMENSIONS IN INCHES																		
MODEL	MOTOR FRAME SIZE	DISC NPT (in)	SUCT. NPT (in)	A	B	CP	D	DD	E	F	G	L	O	OP	P	X	Y	Z
GA5-1	56	1	1¼	5 ³ / ₁₆	5	16 ⁷ / ₈	4 ³ / ₄	3 ³ / ₈	1 ¹⁵ / ₁₆	3	3 ³ / ₁₆	5 ¹⁵ / ₁₆	8 ⁹ / ₁₆	9½	1 ⁵ / ₁₆	4 ¹¹ / ₁₆	2 ⁵ / ₈	3 ⁹ / ₁₆
GA5-1¼	56	1¼	1½	5 ³ / ₁₆	5	15 ¹¹ / ₁₆	4 ³ / ₄	3 ³ / ₈	1 ¹⁵ / ₁₆	3	3 ³ / ₁₆	5 ¹⁵ / ₁₆	8 ⁹ / ₁₆	9½	1 ⁵ / ₁₆	4 ¹¹ / ₁₆	2 ⁵ / ₈	3 ³ / ₈
GA6-1¼	56	1¼	1½	5 ³ / ₁₆	5	15 ¹⁵ / ₁₆	4 ³ / ₄	3 ³ / ₄	1 ¹⁵ / ₁₆	3	3 ³ / ₁₆	5 ¹³ / ₁₆	8 ⁹ / ₁₆	9½	1 ⁵ / ₁₆	4 ¹¹ / ₁₆	2 ⁵ / ₈	3 ³ / ₄

DIMENSIONS IN MILLIMETERS																		
MODEL	MOTOR FRAME SIZE	DISC NPT (in)	SUCT. NPT (in)	A	B	CP	D	DD	E	F	G	L	O	OP	P	X	Y	Z
GA5-1	56	1	1¼	132	127	429	121	86	49	76	4.7	151	217	241	33	119	67	90
GA5-1¼	56	1¼	1½	132	127	398	121	86	49	76	4.7	151	217	241	33	119	67	86
GA6-1¼	56	1¼	1½	132	127	398	121	95	49	76	4.7	148	217	241	33	119	67	95

DIMENSIONS SHOWN ABOVE ARE APPROXIMATE MAXIMUM DIMENSIONS FOR STANDARD PUMPS EQUIPPED WITH ODP MOTORS.

Noryl option specifications same as above.

©Noryl is a registered trademark of General Electric.

Close Coupled Centrifugal Pumps

3500 RPM

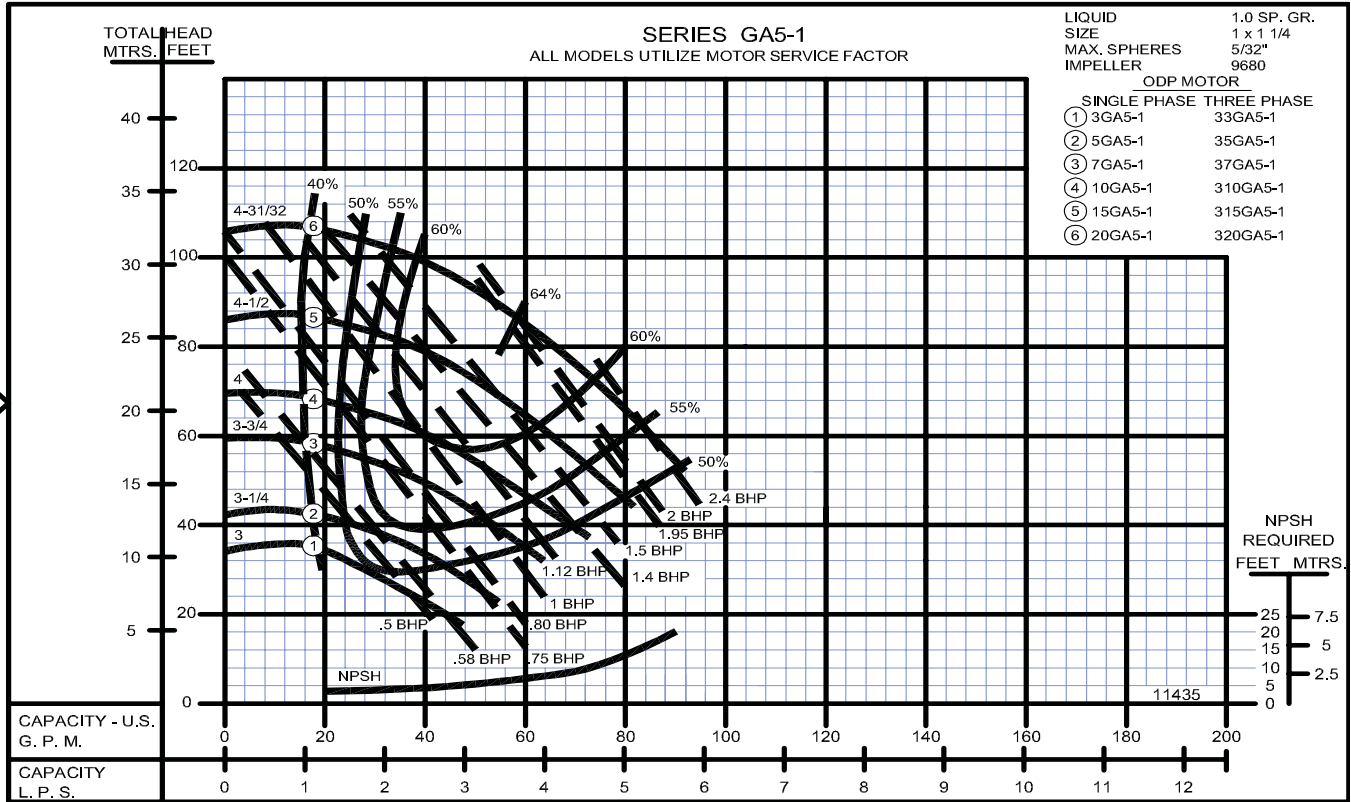

3500 RPM

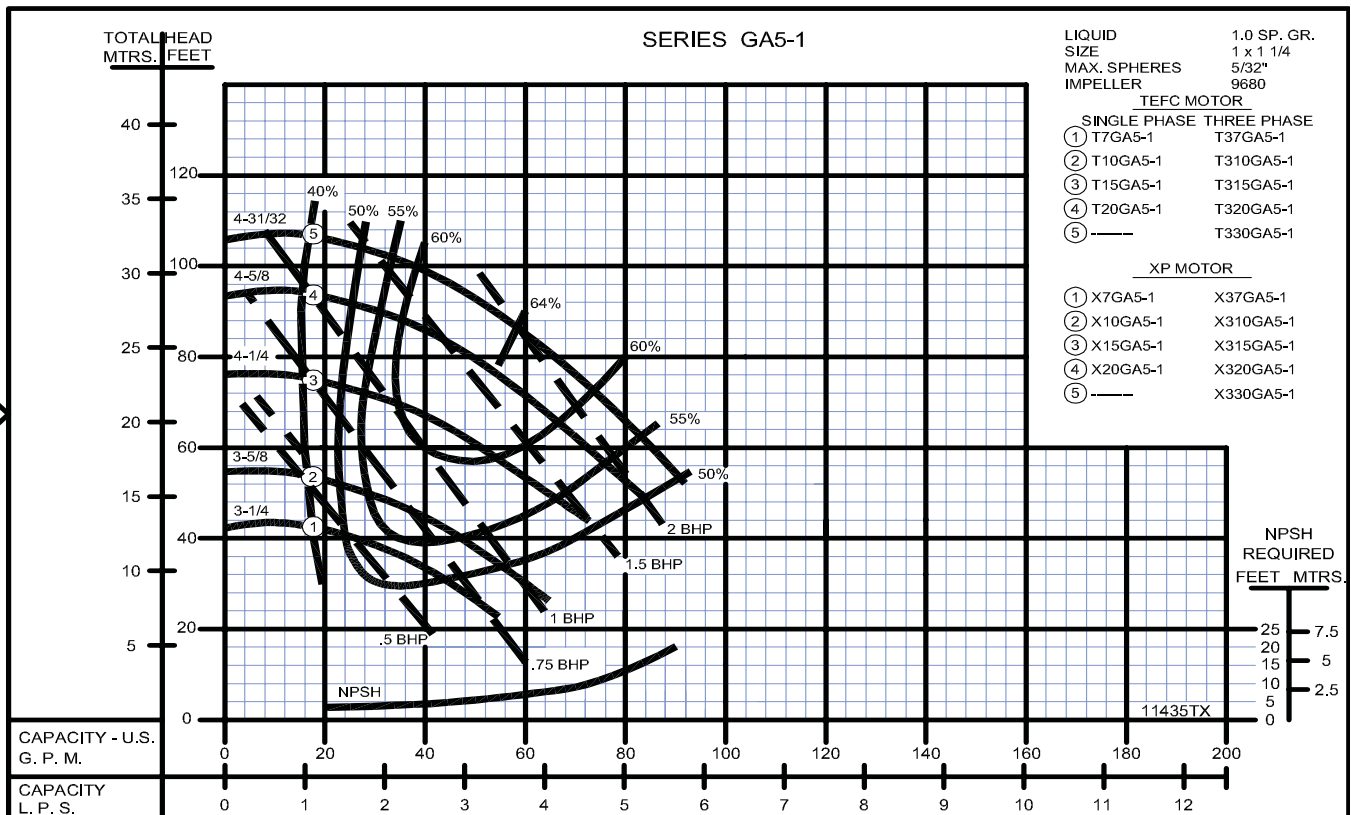

Close Coupled Centrifugal Pumps

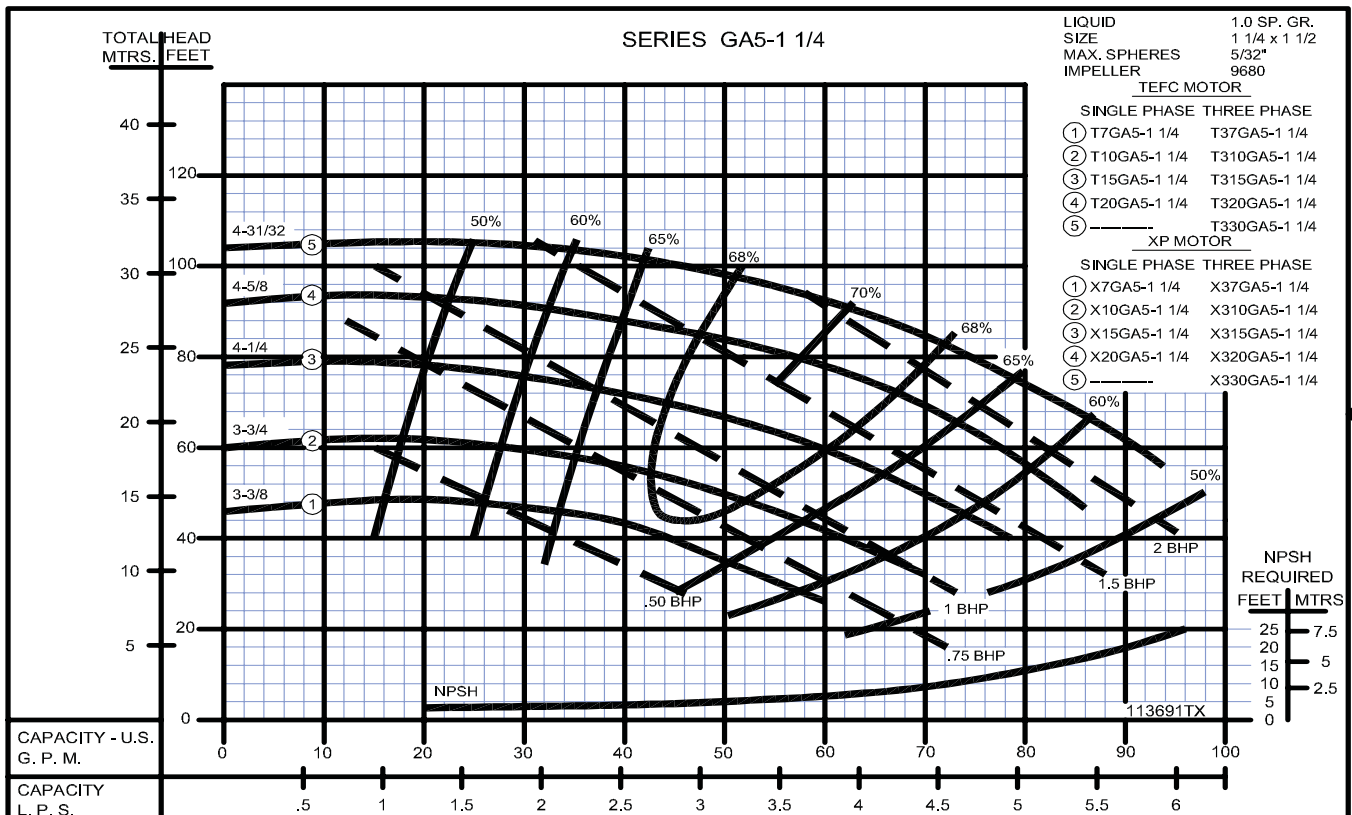
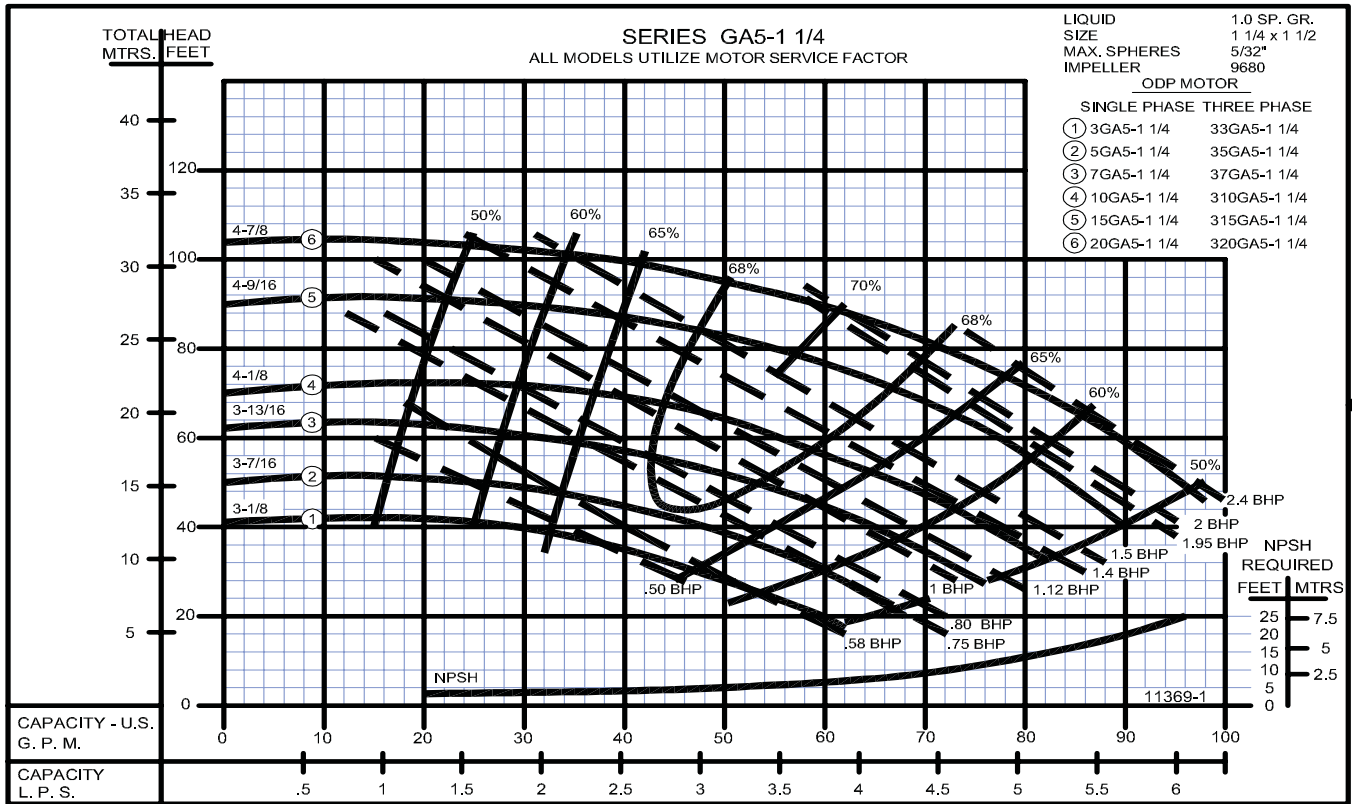

Close Coupled Centrifugal Pumps



Close Coupled Centrifugal Pumps

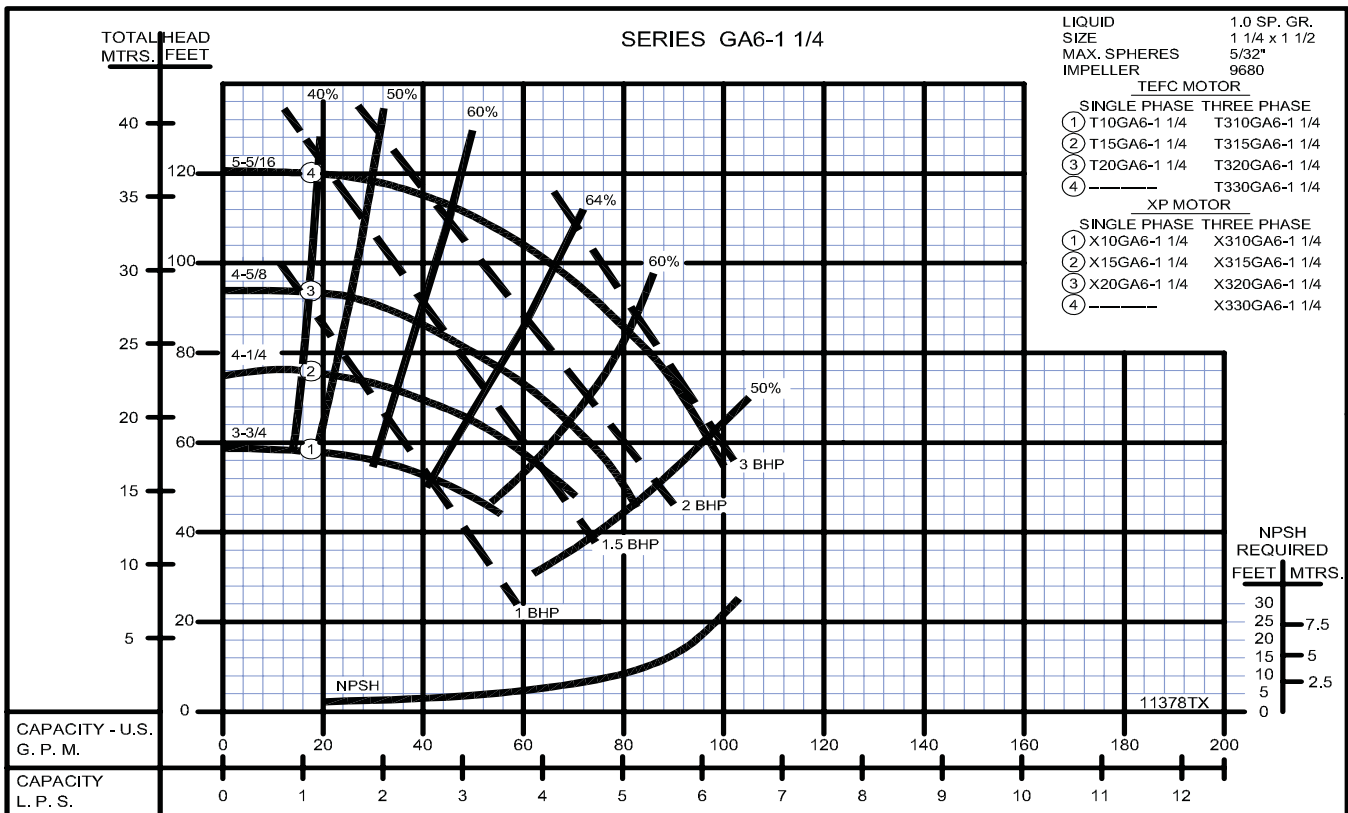
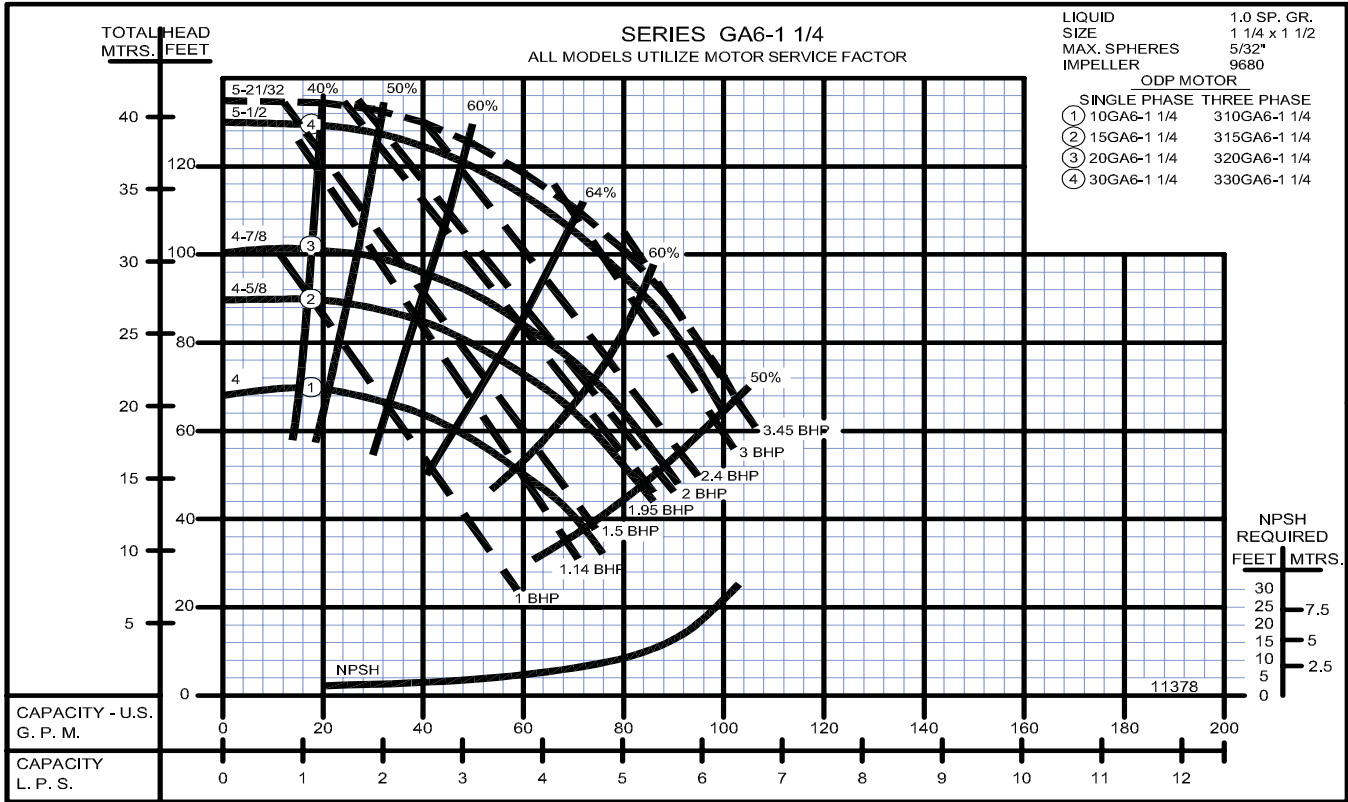

Close Coupled Centrifugal Pumps

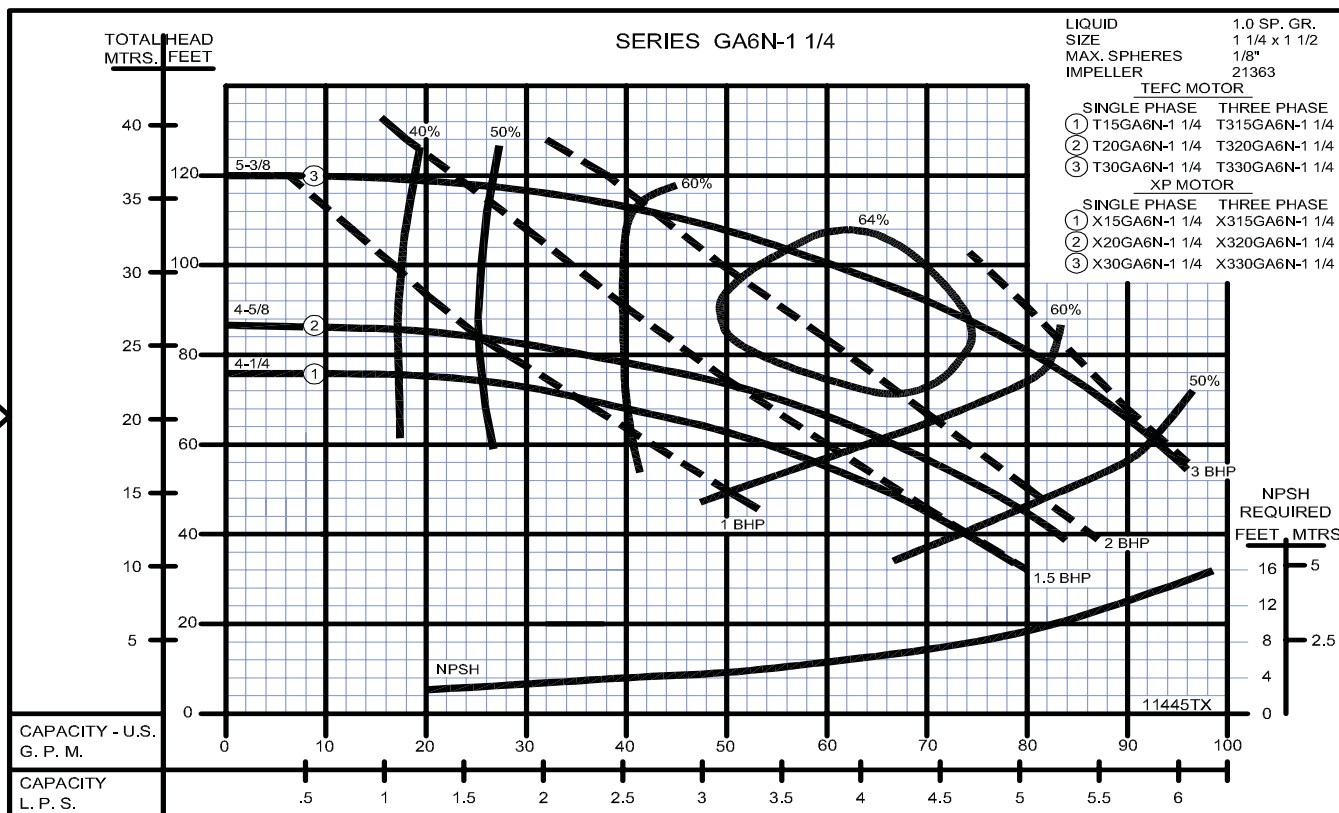
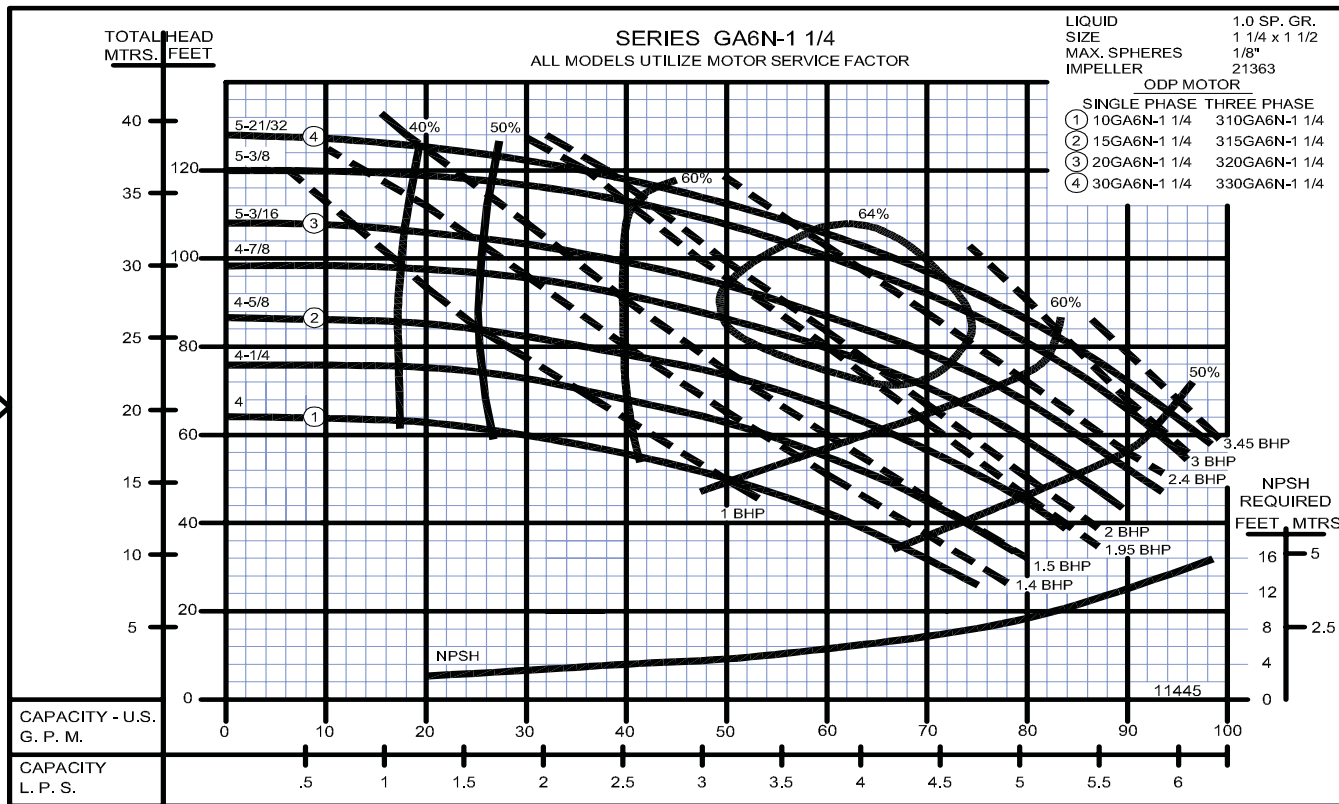

3500 RPM

3500 RPM

Close Coupled Centrifugal Pumps

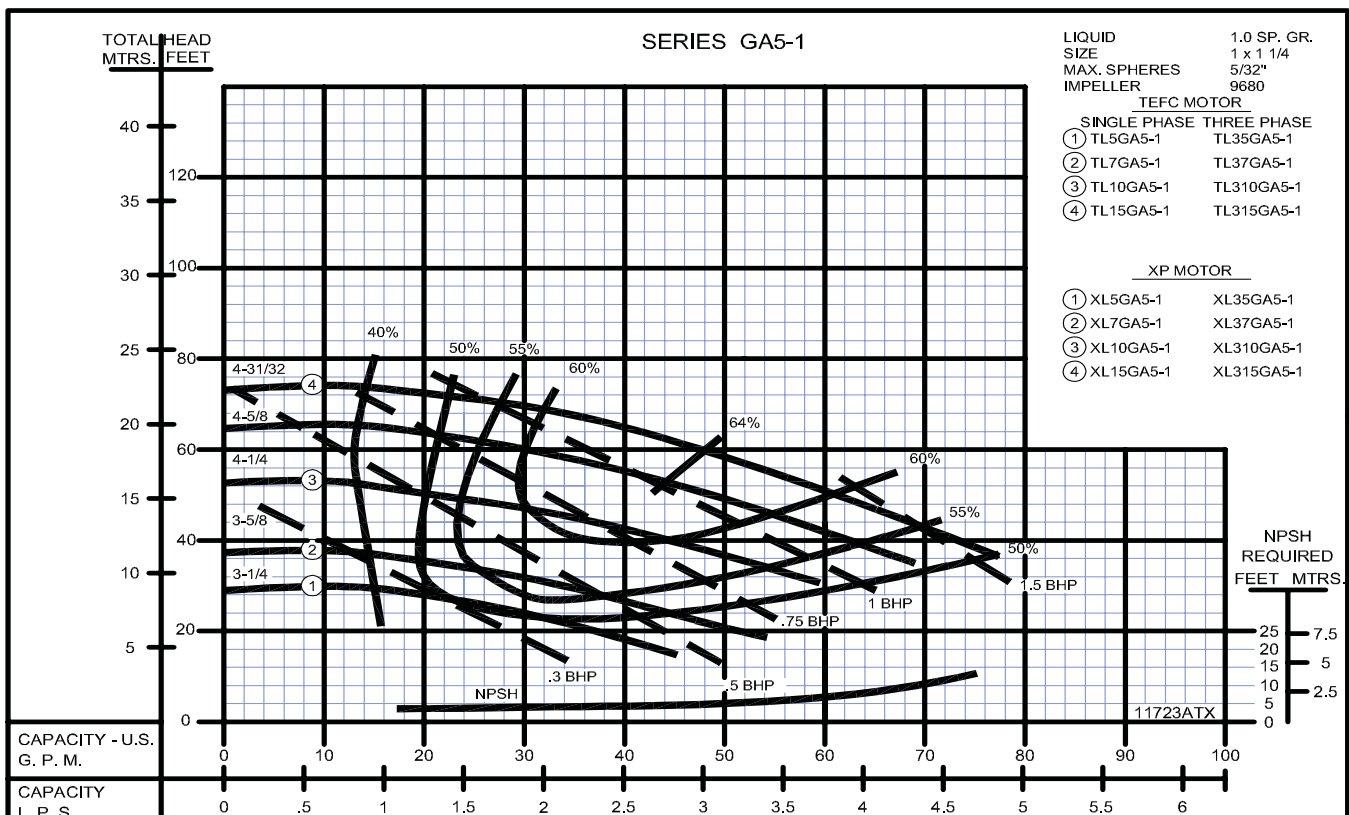

Close Coupled Centrifugal Pumps

2900 RPM

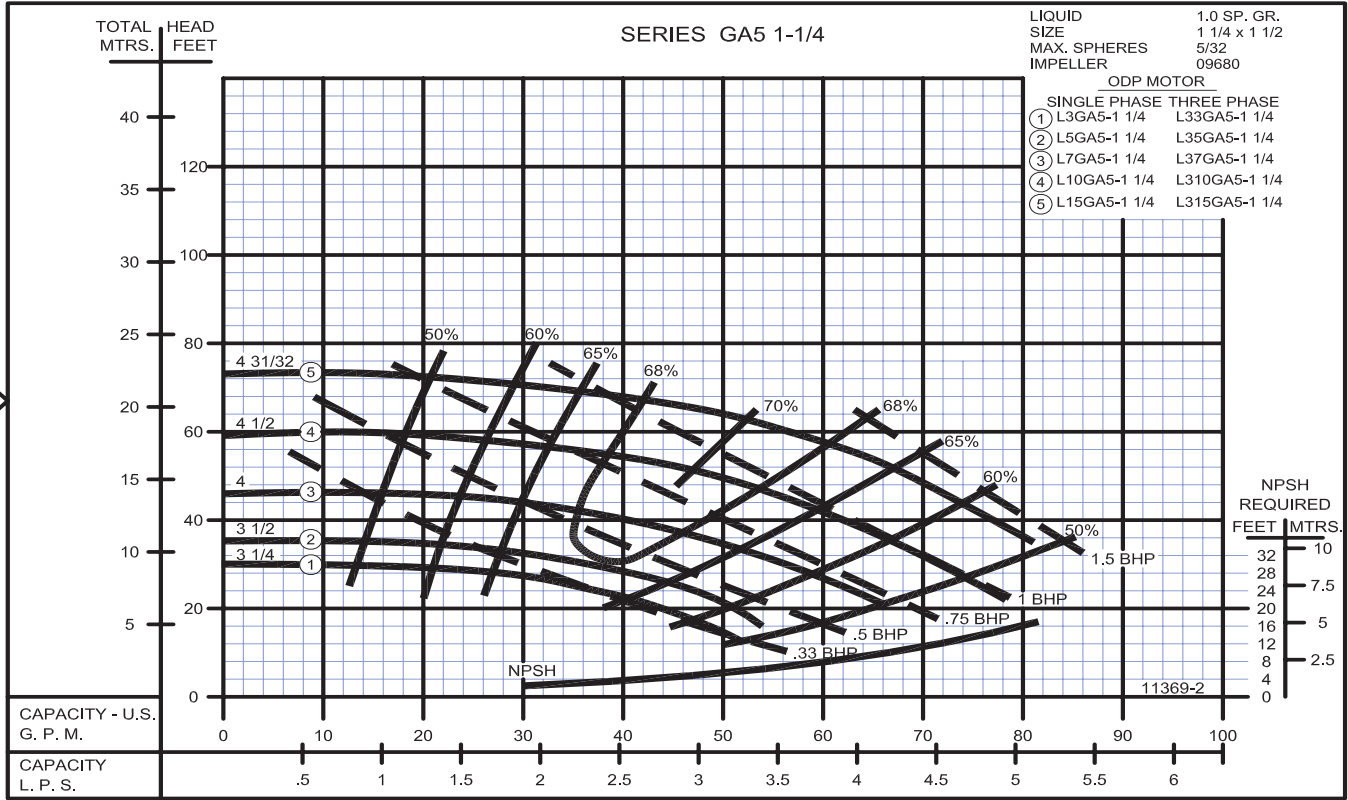

2900 RPM

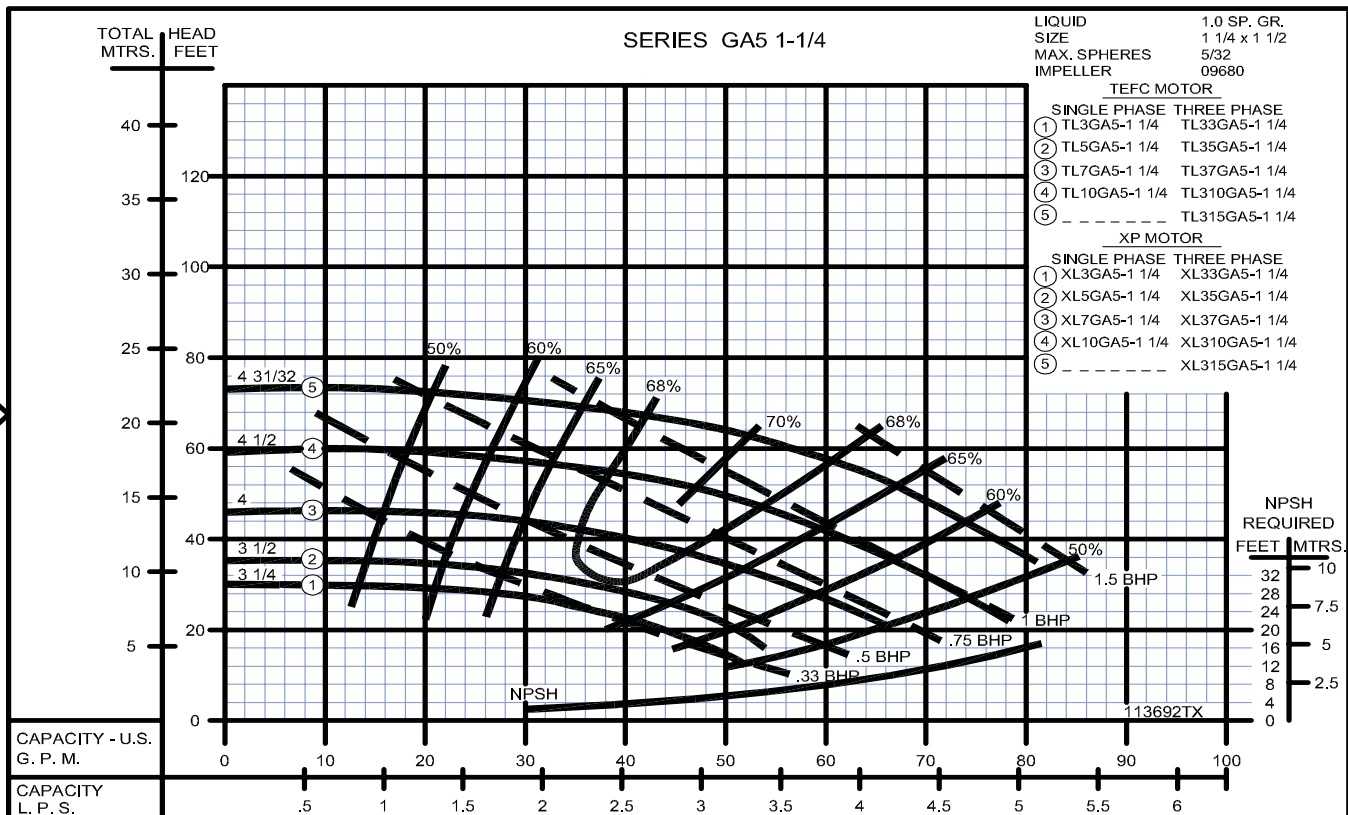

Close Coupled Centrifugal Pumps

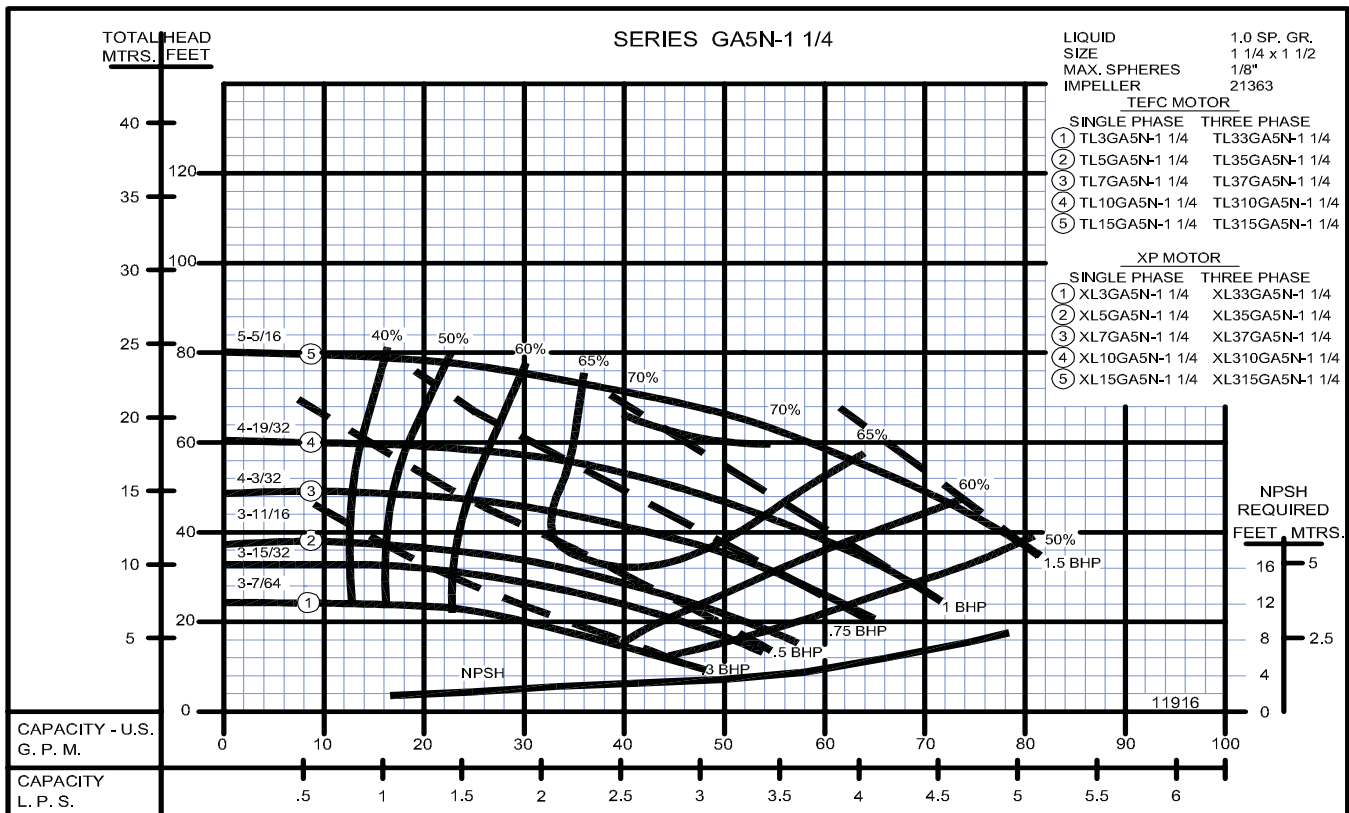
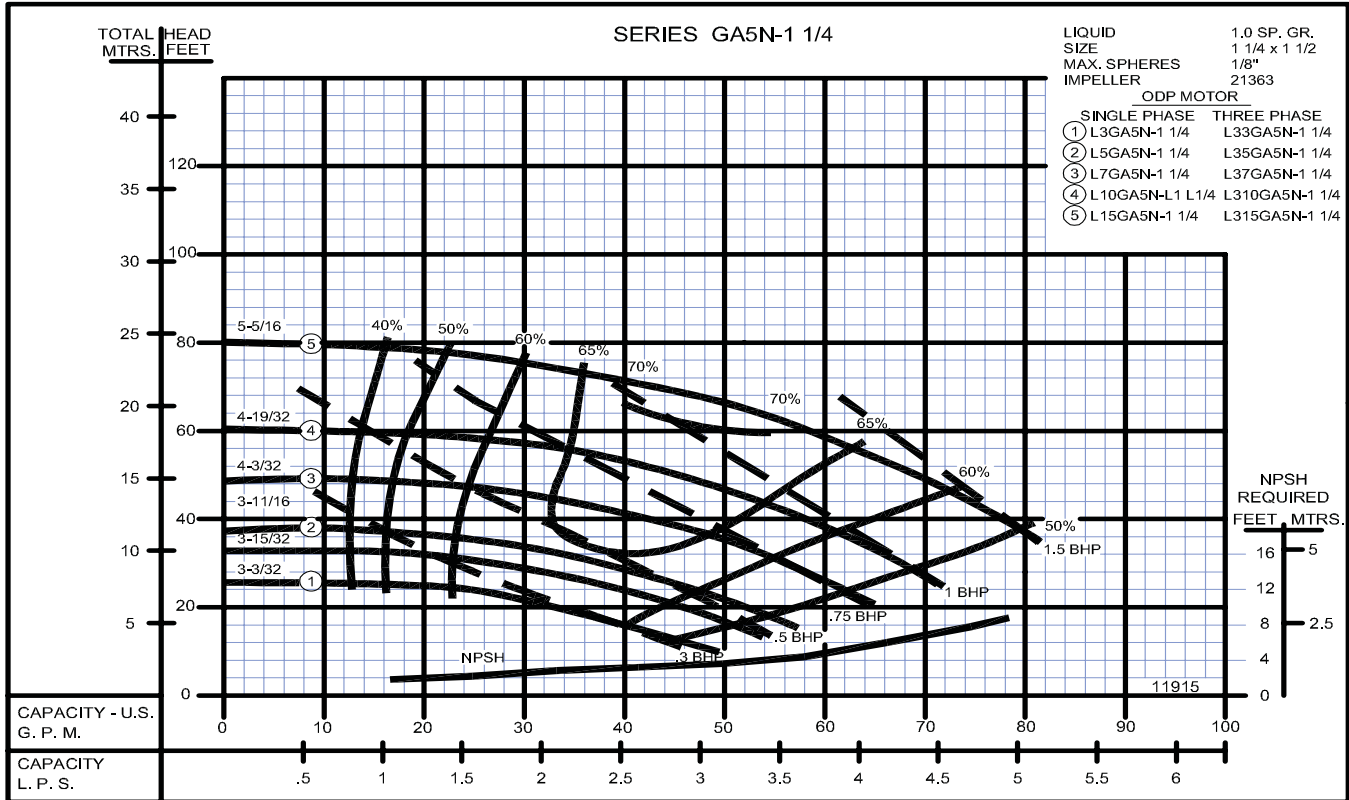

Close Coupled Centrifugal Pumps

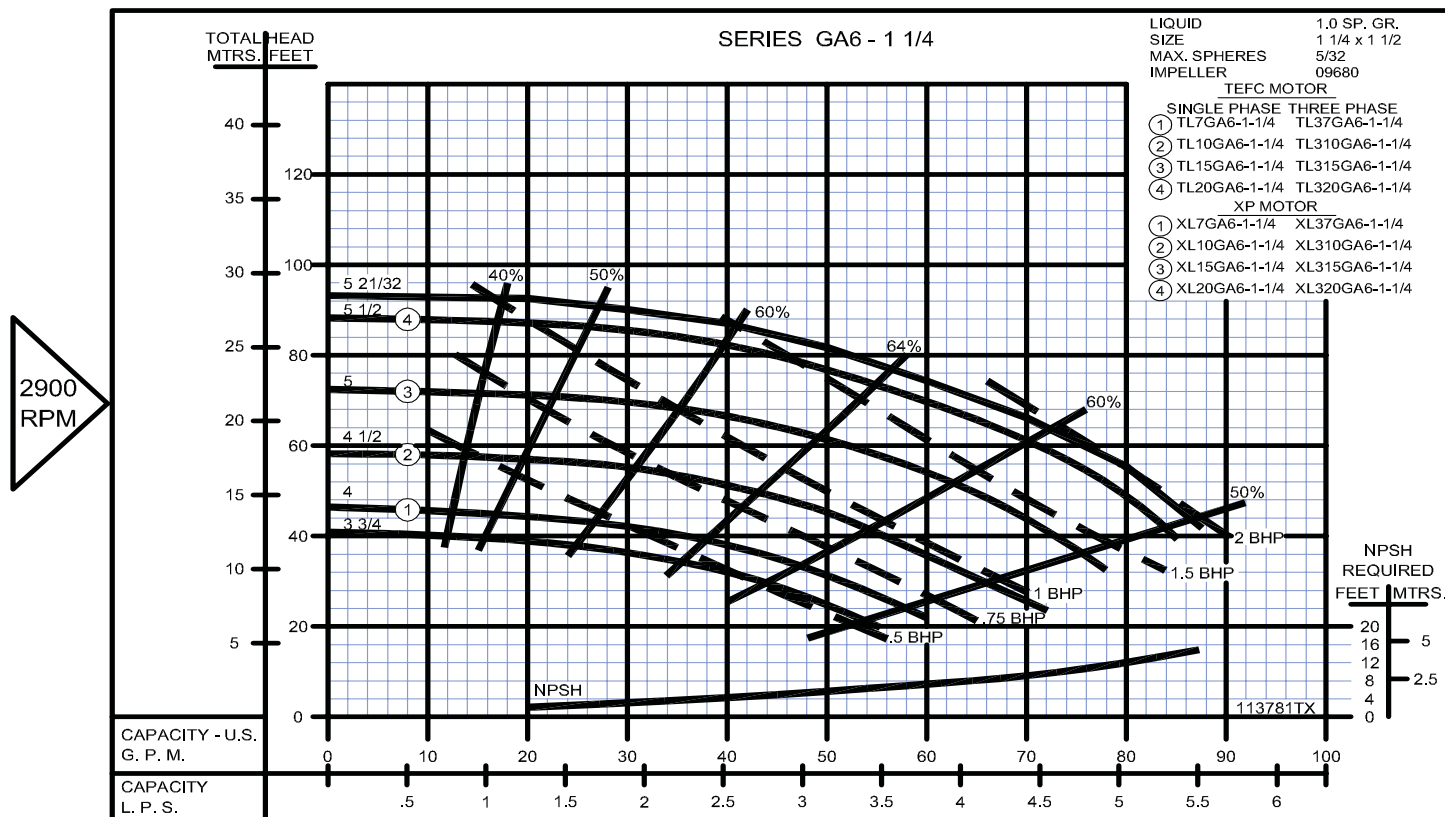
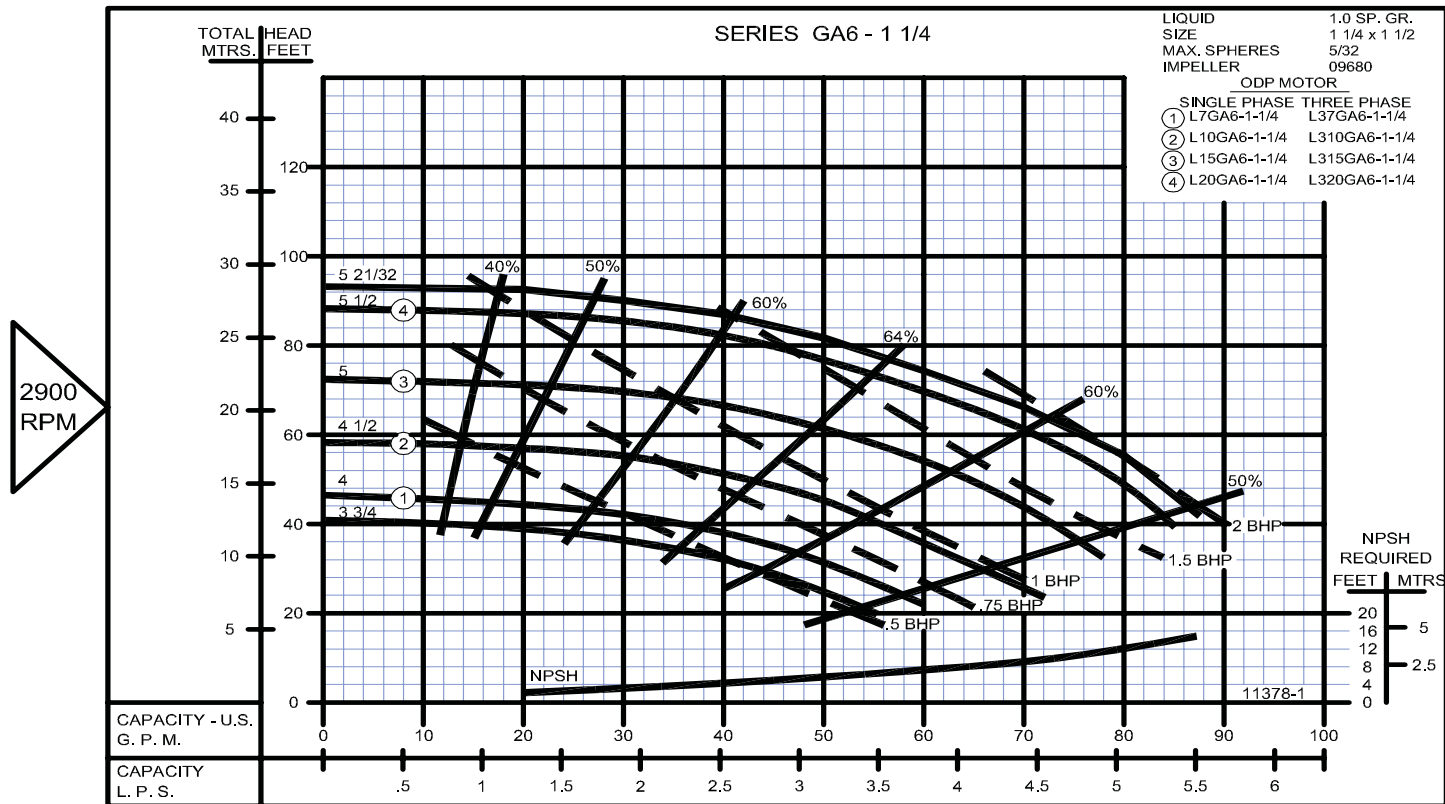

SECTION 2A
PAGE 24
DATE 1/06

CRANE[®]

PUMPS & SYSTEMS

A Crane Co. Company

USA: (937) 778-8947 • Canada: (905) 457-6223 • International: (937) 615-3598

Close Coupled Centrifugal Pumps

