

Close Coupled Centrifugal Pumps



1750 RPM - 60Hz.
 CAPACITIES TO 1100 GPM (69.4 LPS)
 HEADS TO 95 FEET (29 M)

* FOR CAPACITIES ABOVE 500 GPM
 SEE 4G9-4F CURVE.



1450 RPM - 50Hz.
 CAPACITIES TO 340 GPM (21.5 LPS)
 HEADS TO 63 FEET (19 M)

Individual performance curves should be
 checked for final selection.



Close Coupled Centrifugal Pumps

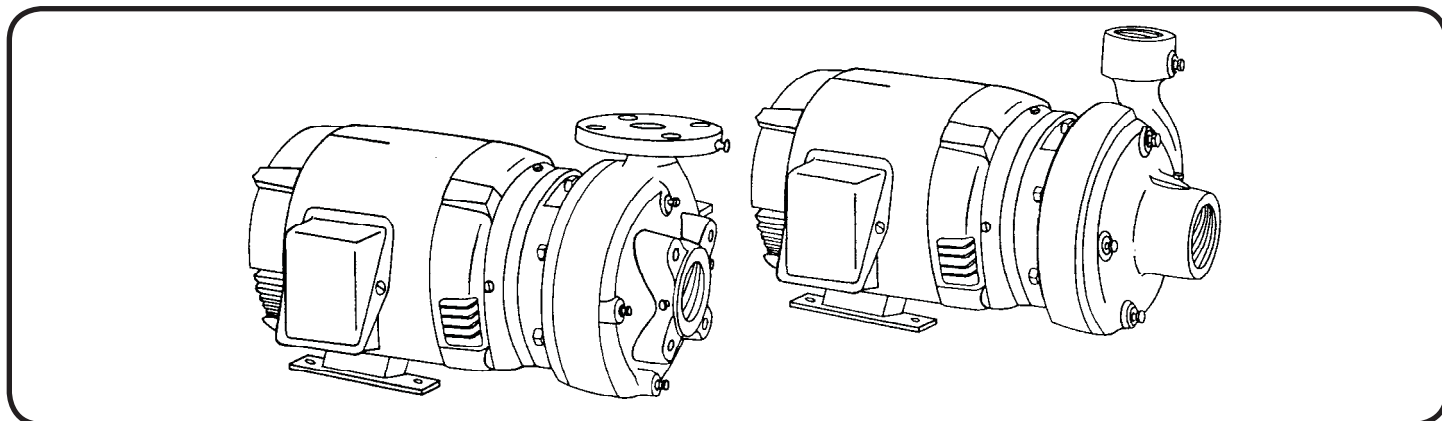

3500 RPM - 60Hz.
CAPACITIES TO 960 GPM (60.6 LPS)
HEADS TO 380 FEET (116 M)



2900 RPM - 50Hz.
CAPACITIES TO 630 GPM (39.7 LPS)
HEADS TO 265 FEET (80.8 M)

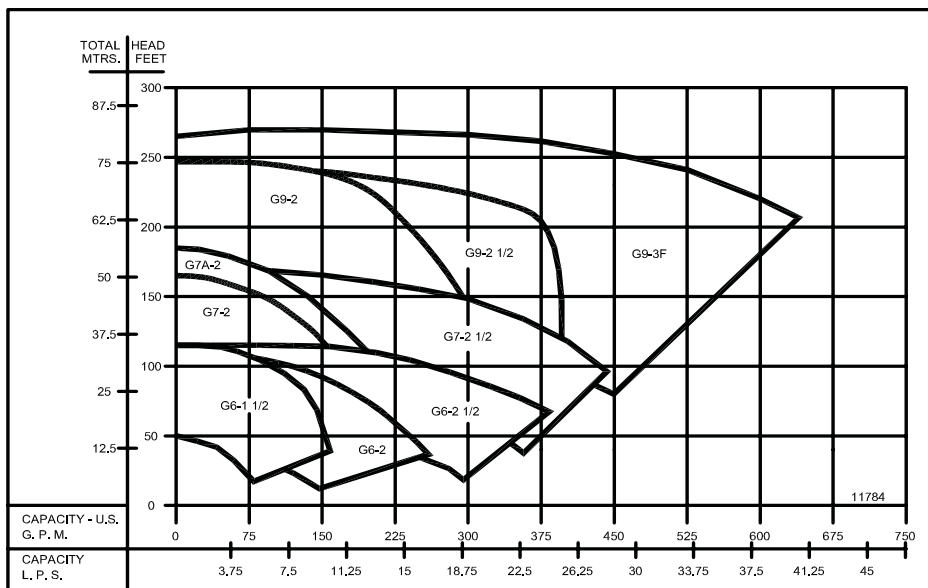

Individual performance curves should be checked for final selection.

Close Coupled Centrifugal Pumps



1. RADIAL SPLIT CASING DESIGN

Casing is close grain iron of 30,000 p.s.i. minimum tensile strength. Back pull-out design eliminates the need to disturb piping should the pump ever require service - the casing stays in the line. Centerline discharge. Stud mounted casing assures positive alignment and allows rotation of discharge to eight different positions. Openings are provided for test gauges, for venting and for draining the pump.

2. ENCLOSED BRONZE IMPELLER

Enclosed bronze impeller is of latest hydraulic design for maximum efficiency. It is balanced for vibration free operation. Precision fit to shaft and double-locked with key and cap screw.

3. REPLACEABLE CASING WEAR RING

Prevents wear on casing and is easy to replace.

4. MECHANICAL SHAFT SEAL

Mechanical Shaft Seal is self-adjusting for temperatures up to 225°F (107°C) and pressures to 150 psi (1034kpa). Has ceramic seat and carbon seal faces for long trouble-free service. Special seals are available for higher temperatures and fluids other than water. Tapped opening is provided in the seal chamber for flushing seal faces.

MAXIMUM OPERATING CONDITIONS

Maximum Pumping Temperature*	225°F (107°C)
Maximum inlet Pressure	100 PSI (690kpa)
Maximum Case Working Pressure	200 PSI (1379kpa)

* FOR STANDARD BUNA-N SEAL

MATERIALS OF CONSTRUCTION

Part	Brone Fitted	All Bronze	All Iron
Adapter	Cast Iron	Bronze	Cast Iron
Casing	Cast Iron	Bronze	Cast Iron
Casing Wear Ring	Bronze	Bronze	Steel
Shaft	Steel	Steel	Steel
Shaft Sleeve	Bronze	Bronze	#316 Stainless
Impeller	Bronze	Bronze	Cast Iron
Shaft Seal	Carbon-Ceramic SS - Buna-N	Carbon-Ceramic SS - Buna-N	Carbon-Ceramic SS - Buna-N

5. BRONZE SHAFT SLEEVE

Gasketed and keyed hook-type sleeve protects shaft wear and corrosion in seal area.

6. MOTORS

The standard Type JM motors supplied with these pumps offer the advantages of quiet operation, controlled shaft deflection for longer mechanical seal life and bearings sized to provide good service life. All motors are **supplied by** manufacturers providing field service facilities.

7. INTERCHANGEABILITY

The complete liquid end of any size pump is interchangeable between motors on close-coupled pumps and the BURKS power frames of comparable size providing inventory flexibility, plus an option for handling emergency service.

8. FACTORY TESTED

After careful assembly and inspection, EVERY pump is factory tested and will meet Hydraulic Institute standards.

FOR TEMPERATURES TO 500°F (260°C).

All models, with the exception of the G7-2-1/2 and all G9 series pumps are available in a Jacketed Seal Cavity design for pumping hot oil, hot water and heat transfer fluids in common use in high temperature heating or cooling applications. This feature greatly extends seal life in high temperature applications. To order, add suffix "MJ" to pump catalog number for temperatures below 400°F (204°C) and add suffix "MJK" to pump catalog number for temperatures over 400°F (204°C). Example: G6-1-1/2MJ. See Section on High Temperature Pumps for more information.

SUCTION & DISCHARGE SIZES

* SERIES	SUCTION (in)	DISCHARGE (in)
G6-1-1/2	2	1-1/2
G-2 & 2F	2-1/2	2
G6-2-1/2 & 2-1/2F	3	2-1/2
G7-2 & 2F	2-1/2	2
G7A-2 & 2F	2-1/2	2
G7-2-1/2 & 2-1/2F	3	2-1/2
G9-1-1/2	2	1-1/2
G9-2 & 2F	2-1/2	2
G9-2-1/2 & 2-1/2F	3	2-1/2
G9-3F & G9A-3F	4	3
G9-4F	5	4

*F Suffix Denotes ANSI 125# Flat Face Flanges

Series: 4G6-1½, 4G6-2, 4G6-2½

G6-1½, G6-2, G6-2½

Dimensions with Screwed NPT Casing



www.cranepumps.com

Close Coupled Centrifugal Pumps



DIMENSIONS IN INCHES

MODEL		HP	MOTOR FRAME SIZE	DISC NPT (in)	SUCT NPT (in)	A	AB	B	CP	D	DD	E	F	G	H	L	X	Y		
1 Phase	3 Phase																			
1750 & 1450 RPM																				
104G6-1½	3104G6-1½	1	143JM	1½	2	7	8 ¹⁵ / ₁₆	5	15 ⁷ / ₈	3½	4 ¹ / ₈	2¾	4	¾	1 ¹ / ₃₂	9 ⁷ / ₁₆	7¼	2¾		
104G6-2	3104G6-2	1	143JM	2	2½	7	8 ¹⁵ / ₁₆	5	16	3½	4½	2¾	4	¾	1 ¹ / ₃₂	9 ⁹ / ₁₆	7½	2 ¹³ / ₁₆		
154G6-2	3154G6-2	1½	145JM			7	8 ¹⁵ / ₁₆	6	17	3½	4½	2¾	5	¾	1 ¹ / ₃₂	9 ⁹ / ₁₆	7½	2 ¹³ / ₁₆		
104G6-2½	3104G6-2½	1	143JM	2½	3	7	8 ¹⁵ / ₁₆	5	16 ¹¹ / ₁₆	3½	5	2¾	4	¾	1 ¹ / ₃₂	10¼	8¼	3 ⁵ / ₁₆		
154G6-2½	3154G6-2½	1½	145JM			7	8 ¹⁵ / ₁₆	6	17 ¹¹ / ₁₆	3½	5	2¾	5	¾	1 ¹ / ₃₂	10¼	8¼	3 ⁵ / ₁₆		
204G6-2½	-----	2	182JM			8¾	9 ⁷ / ₈	5¾	8½	4½	5	3¾	4½	½	1 ³ / ₃₂	11	8¼	3 ⁵ / ₁₆		
-----	3204G6-2½	2	145JM			7	8 ¹⁵ / ₁₆	6	17 ¹¹ / ₁₆	3½	5	2¾	5	¾	1 ¹ / ₃₂	10¼	8¼	3 ⁵ / ₁₆		
3500 & 2900 RPM																				
15G6-1½	-----	1½	143JM	1½	2	7	8 ¹⁵ / ₁₆	5	15 ⁷ / ₈	3½	4 ¹ / ₈	2¾	4	¾	1 ¹ / ₃₂	9 ⁷ / ₁₆	7¼	2¾		
-----	315G6-1½	1½	143JM			7	8 ¹⁵ / ₁₆	5	15 ⁷ / ₈	3½	4 ¹ / ₈	2¾	4	¾	1 ¹ / ₃₂	9 ⁷ / ₁₆	7¼	2¾		
20G6-1½	-----	2	145JM			7	8 ¹⁵ / ₁₆	6	16 ⁷ / ₈	3½	4 ¹ / ₈	2¾	5	¾	1 ¹ / ₃₂	9 ⁷ / ₁₆	7¼	2¾		
-----	320G6-1½	2	145JM			7	8 ¹⁵ / ₁₆	6	16 ⁷ / ₈	3½	4 ¹ / ₈	2¾	5	¾	1 ¹ / ₃₂	9 ⁷ / ₁₆	7¼	2¾		
30G6-1½	-----	3	182JM			8¾	9 ⁷ / ₈	5¾	17 ¹¹ / ₁₆	4½	4 ¹ / ₈	3¾	4½	½	1 ³ / ₃₂	10 ³ / ₁₆	7¼	2¾		
-----	330G6-1½	3	145JM			7	8 ¹⁵ / ₁₆	6	16 ⁷ / ₈	3½	4 ¹ / ₈	2¾	5	¾	1 ¹ / ₃₂	9 ⁷ / ₁₆	7¼	2¾		
50G6-1½	-----	5	184JM			8¾	9 ⁷ / ₈	6¾	18 ¹¹ / ₁₆	4½	4 ¹ / ₈	3¾	5½	½	1 ³ / ₃₂	10 ³ / ₁₆	7¼	2¾		
-----	350G6-1½	5	182JM			8¾	9 ⁷ / ₈	5¾	17 ¹¹ / ₁₆	4½	4 ¹ / ₈	3¾	4½	½	1 ³ / ₃₂	10 ³ / ₁₆	7¼	2¾		
-----	375G6-1½	7½	184JM			8¾	9 ⁷ / ₈	6¾	18 ¹¹ / ₁₆	4½	4 ¹ / ₈	3¾	5½	½	1 ³ / ₃₂	10 ³ / ₁₆	7¼	2¾		
20G6-2	-----	2	145JM			2	2½	7	8 ¹⁵ / ₁₆	6	17	3½	4½	2¾	5	¾	1 ¹ / ₃₂	9 ⁹ / ₁₆	7½	2 ¹³ / ₁₆
-----	320G6-2	2	145JM	7	8 ¹⁵ / ₁₆			6	17	3½	4½	2¾	5	¾	1 ¹ / ₃₂	9 ⁹ / ₁₆	7½	2 ¹³ / ₁₆		
30G6-2	-----	3	182JM	8¾	9 ⁷ / ₈			5¾	17 ¹³ / ₁₆	4½	4½	3¾	4½	½	1 ³ / ₃₂	10 ⁵ / ₁₆	7½	2 ¹³ / ₁₆		
-----	330G6-2	3	145JM	7	8 ¹⁵ / ₁₆			6	17	3½	4½	2¾	5	¾	1 ¹ / ₃₂	9 ⁹ / ₁₆	7½	2 ¹³ / ₁₆		
50G6-2	-----	5	184JM	8¾	9 ⁷ / ₈			6¾	18 ¹¹ / ₁₆	4½	4½	3¾	5½	½	1 ³ / ₃₂	10 ⁵ / ₁₆	7½	2 ¹³ / ₁₆		
-----	350G6-2	5	182JM	8¾	9 ⁷ / ₈			5¾	17 ¹³ / ₁₆	4½	4½	3¾	4½	½	1 ³ / ₃₂	10 ⁵ / ₁₆	7½	2 ¹³ / ₁₆		
-----	375G6-2	7½	184JM	8¾	9 ⁷ / ₈			6¾	18 ¹¹ / ₁₆	4½	4½	3¾	5½	½	1 ³ / ₃₂	10 ⁵ / ₁₆	7½	2 ¹³ / ₁₆		
-----	3100G6-2	10	213JM	10 ³ / ₈	11 ¹ / ₁₆			7¼	20¼	5¼	4½	4¼	5½	¾	1 ³ / ₃₂	11 ⁷ / ₁₆	7½	2 ¹³ / ₁₆		
-----	375G6-2½	7½	184JM	2½	3			8¾	9 ⁷ / ₈	6¾	19½	4½	5	3¾	5½	½	1 ³ / ₃₂	11	8¼	3 ⁵ / ₁₆
-----	3100G6-2½	10	213JM					10 ³ / ₈	11 ¹ / ₁₆	7¼	21 ¹ / ₁₆	5¼	5	4¼	5½	¾	1 ³ / ₃₂	12 ⁷ / ₈	8¼	3 ⁵ / ₁₆
-----	3150G6-2½	15	215JM			10 ³ / ₈	11 ¹ / ₁₆	8¾	22 ⁷ / ₁₆	5¼	5	4¼	7	¾	1 ³ / ₃₂	12 ⁷ / ₈	8¼	3 ⁵ / ₁₆		
-----	3200G6-2½	20	254JM			12	11 ⁹ / ₁₆	10¼	25 ¹⁵ / ₁₆	6¼	5	5	8¼	7 ¹ / ₈	1 ⁷ / ₃₂	13 ³ / ₈	8¼	3 ⁵ / ₁₆		

DIMENSIONS SHOWN ABOVE ARE APPROXIMATE MAXIMUM DIMENSIONS FOR STANDARD PUMPS EQUIPPED WITH ODP MOTORS.

SECTION 2B
PAGE 12
DATE 8/08



PUMPS & SYSTEMS

A Crane Co. Company

USA: (937) 778-8947 • Canada: (905) 457-6223 • International: (937) 615-3598

Close Coupled Centrifugal Pumps



DIMENSIONS IN MILLIMETERS

MODEL		HP	MOTOR FRAME SIZE	DISC NPT (in)	SUCT NPT (in)	A	AB	B	CP	D	DD	E	F	G	H	L	X	Y
1 Phase	3 Phase																	
1750 & 1450 RPM																		
104G6-1½	3104G6-1½	1	143JM	1½	2	178	227	127	403	89	105	70	102	9.5	8.7	240	184	70
104G6-2	3104G6-2	1	143JM	2	2½	178	227	127	406	89	114	70	102	9.5	8.7	243	191	71
154G6-2	3154G6-2	1½	145JM			178	227	152	432	89	114	70	127	9.5	8.7	243	191	71
104G6-2½	3104G6-2½	1	143JM	2½	3	178	227	127	424	89	127	70	102	9.5	8.7	260	210	84
154G6-2½	3154G6-2½	1½	145JM			178	227	152	449	89	127	70	127	9.5	8.7	260	210	84
204G6-2½	-----	2	182JM			222	251	146	470	114	127	95	114	13	10	279	210	84
-----	3204G6-2½	2	145JM			178	227	152	449	89	127	70	127	9.5	8.7	260	210	84
3500 & 2900 RPM																		
15G6-1½	-----	1½	143JM	1½	2	178	227	127	403	89	105	70	102	9.5	8.7	240	184	70
-----	315G6-1½	1½	143JM			178	227	127	403	89	105	70	102	9.5	8.7	240	184	70
20G6-1½	-----	2	145JM			178	227	152	429	89	105	70	127	9.5	8.7	240	184	70
-----	320G6-1½	2	145JM			178	227	152	429	89	105	70	127	9.5	8.7	240	184	70
30G6-1½	-----	3	182JM			222	251	146	449	114	105	95	114	13	10	259	184	70
-----	330G6-1½	3	145JM			178	227	152	429	89	105	70	127	9.5	8.7	240	184	70
50G6-1½	-----	5	184JM			222	251	172	475	114	105	95	140	13	10	259	184	70
-----	350G6-1½	5	182JM			222	251	146	449	114	105	95	114	13	10	259	184	70
-----	375G6-1½	7½	184JM			222	251	172	475	114	105	95	140	13	10	259	184	70
20G6-2	-----	2	145JM			2	2½	178	227	152	432	89	114	70	127	9.5	8.7	243
-----	320G6-2	2	145JM	178	227			152	432	89	114	70	127	9.5	8.7	243	191	71
30G6-2	-----	3	182JM	222	251			146	452	114	114	95	114	13	10	262	191	71
-----	330G6-2	3	145JM	178	227			152	432	89	114	70	127	9.5	8.7	243	191	71
50G6-2	-----	5	184JM	222	251			172	475	114	114	95	140	13	10	262	191	71
-----	350G6-2	5	182JM	222	251			146	452	114	114	95	114	13	10	262	191	71
-----	375G6-2	7½	184JM	222	251			172	475	114	114	95	140	13	10	262	191	71
-----	3100G6-2	10	213JM	264	281			184	514	133	114	108	140	16	10	291	191	71
-----	375G6-2½	7½	184JM	222	251			172	495	114	127	95	140	13	10	279	210	84
-----	3100G6-2½	10	213JM	264	281			184	535	133	127	108	140	16	10	308	210	84
-----	3150G6-2½	15	215JM	264	281	222	570	133	127	108	178	16	10	308	210	84		
-----	3200G6-2½	20	254JM	305	294	260	659	159	127	127	210	22	13.5	346	210	84		

DIMENSIONS SHOWN ABOVE ARE APPROXIMATE MAXIMUM DIMENSIONS FOR STANDARD PUMPS EQUIPPED WITH ODP MOTORS.

Series: 4G7-2, 4G7A-2, 4G7-2½
 G7-2, G7A-2, G7-2½
 Dimensions with Screwed NPT Casing



Close Coupled Centrifugal Pumps



DIMENSIONS IN INCHES																		
MODEL		HP	MOTOR FRAME SIZE	DISC NPT (in)	SUCTION NPT (in)	A	AB	B	CP	D	DD	E	F	G	H	L	X	Y
1 Phase	3 Phase																	
1750 & 1450 RPM																		
104G7-2	3104G7-2	1	143JM	2	2½	7	8 ¹⁵ / ₁₆	5	16 ⁷ / ₈	3½	5	2¾	4	¾	1 ¹¹ / ₃₂	10 ⁷ / ₁₆	8¼	3¾
154G7-2	3154G7-2	1½	145JM			7	8 ¹⁵ / ₁₆	6	17 ⁷ / ₈	3½	5	2¾	5	¾	1 ¹¹ / ₃₂	10 ⁷ / ₁₆	8¼	3¾
204G7-2	----	2	182JM			8¾	9 ⁷ / ₈	5¾	18 ¹¹ / ₁₆	4½	5	3¾	4½	½	1 ¹³ / ₃₂	11 ³ / ₁₆	8¼	3¾
----	3204G7-2	2	145JM			7	8 ¹⁵ / ₁₆	6	17 ⁷ / ₈	3½	5	2¾	5	¾	1 ¹¹ / ₃₂	10 ⁷ / ₁₆	8¼	3¾
104G7A-2	310G7A-2	1	143JM	2	2½	7	8 ¹⁵ / ₁₆	5	16 ⁷ / ₈	3½	5	2¾	4	¾	1 ¹¹ / ₃₂	10 ⁷ / ₁₆	8¼	3¾
154G7A-2	3154G7A-2	1½	145JM			7	8 ¹⁵ / ₁₆	6	17 ⁷ / ₈	3½	5	2¾	5	¾	1 ¹¹ / ₃₂	10 ⁷ / ₁₆	8¼	3¾
204G7A-2	----	2	182JM			8¾	9 ⁷ / ₈	5¾	18 ¹¹ / ₁₆	4½	5	3¾	4½	½	1 ¹³ / ₃₂	11 ³ / ₁₆	8¼	3¾
----	3204G7A-2	2	145JM			7	8 ¹⁵ / ₁₆	6	17 ⁷ / ₈	3½	5	2¾	5	¾	1 ¹¹ / ₃₂	10 ⁷ / ₁₆	8¼	3¾
154G7-2½	3154G7-2½	1½	145JM	2½	3	7	8 ¹⁵ / ₁₆	6	17 ⁷ / ₈	3½	5½	2¾	5	¾	1 ¹¹ / ₃₂	10 ⁷ / ₁₆	9¼	3½
204G7-2½	----	2	182JM			8¾	9 ⁷ / ₈	5¾	18 ¹¹ / ₁₆	4½	5½	3¾	4½	½	1 ¹³ / ₃₂	11 ³ / ₁₆	9¼	3½
----	3204G7-2½	2	145JM			7	8 ¹⁵ / ₁₆	6	17 ⁷ / ₈	3½	5½	2¾	5	¾	1 ¹¹ / ₃₂	10 ⁷ / ₁₆	9¼	3½
304G7-2½	----	3	184JM			8¾	9 ⁷ / ₈	6¾	19 ¹¹ / ₁₆	4½	5½	3¾	5½	½	1 ¹³ / ₃₂	11 ³ / ₁₆	9¼	3½
----	3304G7-2½	3	182JM			8¾	9 ⁷ / ₈	5¾	18 ¹¹ / ₁₆	4½	5½	3¾	4½	½	1 ¹³ / ₃₂	11 ³ / ₁₆	9¼	3½
3500 & 2900 RPM																		
50G7-2	----	5	184JM	2	2½	8¾	9 ⁷ / ₈	6¾	19 ¹¹ / ₁₆	4½	5	3¾	5½	½	1 ¹³ / ₃₂	11 ³ / ₁₆	8¼	3¾
----	350G7-2	5	182JM			8¾	9 ⁷ / ₈	5¾	18 ¹¹ / ₁₆	4½	5	3¾	4½	½	1 ¹³ / ₃₂	11 ³ / ₁₆	8¼	3¾
----	375G7-2	7½	184JM			8¾	9 ⁷ / ₈	6¾	19 ¹¹ / ₁₆	4½	5	3¾	5½	½	1 ¹³ / ₃₂	11 ³ / ₁₆	8¼	3¾
----	3100G7-2	10	213JM			10 ³ / ₈	11 ¹ / ₁₆	7¼	21¼	5¼	5	4¼	5½	5 ⁵ / ₈	1 ¹³ / ₃₂	12 ⁵ / ₁₆	8¼	3¾
50G7A-2	----	5	184JM	2	2½	8¾	9 ⁷ / ₈	6¾	19 ¹¹ / ₁₆	4½	5	3¾	5½	½	1 ¹³ / ₃₂	11 ³ / ₁₆	8¼	3¾
----	350G7A-2	5	182JM			8¾	9 ⁷ / ₈	5¾	18 ¹¹ / ₁₆	4½	5	3¾	4½	½	1 ¹³ / ₃₂	11 ³ / ₁₆	8¼	3¾
----	375G7A-2	7½	184JM			8¾	9 ⁷ / ₈	6¾	19 ¹¹ / ₁₆	4½	5	3¾	5½	½	1 ¹³ / ₃₂	11 ³ / ₁₆	8¼	3¾
----	3100G7A-2	10	213JM			10 ³ / ₈	11 ¹ / ₁₆	7¼	21¼	5¼	5	4¼	5½	5 ⁵ / ₈	1 ¹³ / ₃₂	12 ⁵ / ₁₆	8¼	3¾
----	3150G7A-2	15	215JM	10 ³ / ₈	11 ¹ / ₁₆	8¾	22 ⁵ / ₈	5¼	5	4¼	7	5 ⁵ / ₈	1 ¹³ / ₃₂	12 ⁵ / ₁₆	8¼	3¾		
----	3150G7-2½	15	215JM	2½	3	10 ³ / ₈	11 ¹ / ₁₆	8¾	22 ⁵ / ₈	5¼	5½	4¼	7	5 ⁵ / ₈	1 ¹³ / ₃₂	12 ⁵ / ₁₆	9¼	3½
----	3200G7-2½	20	254JM			12	11 ¹ / ₁₆	10¼	26 ³ / ₁₆	6¼	5½	5	8¼	7 ⁵ / ₈	1 ¹⁷ / ₃₂	13 ⁷ / ₈	9¼	3½
----	3250G7-2½	25	256JM			12	11 ¹ / ₁₆	12	27 ¹⁵ / ₁₆	6¼	5½	5	10	7 ⁵ / ₈	1 ¹⁷ / ₃₂	13 ⁷ / ₈	9¼	3½
----	3300G7-2½	30	284JM			13¾	13	11½	27 ¹⁵ / ₁₆	7	5½	5½	9½	7 ⁵ / ₈	1 ¹⁷ / ₃₂	13 ⁷ / ₈	9¼	3½

DIMENSIONS SHOWN ABOVE ARE APPROXIMATE MAXIMUM DIMENSIONS FOR STANDARD PUMPS EQUIPPED WITH ODP MOTORS.

SECTION 2B
 PAGE 14
 DATE 1/06



PUMPS & SYSTEMS

A Crane Co. Company

USA: (937) 778-8947 • Canada: (905) 457-6223 • International: (937) 615-3598

Close Coupled Centrifugal Pumps



DIMENSIONS IN MILLIMETERS																		
MODEL		HP	MOTOR FRAME SIZE	DISC NPT (in)	SUCT NPT (in)	A	AB	B	CP	D	DD	E	F	G	H	L	X	Y
1 Phase	3 Phase																	
1750 & 1450 RPM																		
104G7-2	3104G7-2	1	143JM	2	2½	178	227	127	429	89	127	70	102	9.5	8.7	265	210	95
154G7-2	3154G7-2	1½	145JM			178	227	152	454	89	127	70	127	9.5	8.7	265	210	95
204G7-2	----	2	182JM			222	251	146	475	114	127	95	114	13	10.3	284	210	95
----	3204G7-2	2	145JM			178	227	152	454	89	127	70	127	9.5	8.7	265	210	95
104G7A-2	310G7A-2	1	143JM	2	2½	178	227	127	429	89	127	70	102	9.5	8.7	265	210	95
154G7A-2	3154G7A-2	1½	145JM			178	227	152	454	89	127	70	127	9.5	8.7	265	210	95
204G7A-2	----	2	182JM			222	251	146	475	114	127	95	114	13	10.3	284	210	95
----	3204G7A-2	2	145JM			178	227	152	454	89	127	70	127	9.5	8.7	265	210	95
154G7-2½	3154G7-2½	1½	145JM	2½	3	178	227	152	454	89	140	70	127	9.5	8.7	265	235	89
204G7-2½	----	2	182JM			222	251	146	475	114	140	95	114	13	10.3	284	235	89
----	3204G7-2½	2	145JM			178	227	152	454	89	140	70	127	9.5	8.7	265	235	89
304G7-2½	----	3	184JM			222	251	172	500	114	140	95	140	13	10.3	284	235	89
----	3304G7-2½	3	182JM			222	251	146	475	114	140	95	114	13	10.3	284	235	89
3500 & 2900 RPM																		
50G7-2	----	5	184JM	2	2½	222	251	172	500	114	127	95	140	13	10.3	284	210	95
----	350G7-2	5	182JM			222	251	146	475	114	127	95	114	13	10.3	284	210	95
----	375G7-2	7½	184JM			222	251	172	500	114	127	95	140	13	10.3	284	210	95
----	3100G7-2	10	213JM			264	281	184	540	133	127	108	140	16	10.3	313	210	95
50G7A-2	----	5	184JM	2	2½	222	251	172	500	114	127	95	140	13	10.3	284	210	95
----	350G7A-2	5	182JM			222	251	146	475	114	127	95	114	13	10.3	284	210	95
----	375G7A-2	7½	184JM			222	251	172	500	114	127	95	140	13	10.3	284	210	95
----	3100G7A-2	10	213JM			264	281	184	540	133	127	108	140	16	10.3	313	210	95
----	3150G7A-2	15	215JM	264	281	222	575	133	127	108	178	16	10.3	313	210	95		
----	3150G7-2½	15	215JM	2½	3	264	281	222	575	133	140	108	178	16	10.3	313	235	89
----	3200G7-2½	20	254JM			305	294	260	665	159	140	127	210	22	13.5	352	235	89
----	3250G7-2½	25	256JM			305	294	305	710	159	140	127	254	22	13.5	352	235	89
----	3300G7-2½	30	284JM			349	330	292	710	178	140	140	241	22	13.5	352	235	89

DIMENSIONS SHOWN ABOVE ARE APPROXIMATE MAXIMUM DIMENSIONS FOR STANDARD PUMPS EQUIPPED WITH ODP MOTORS.

Series: 4G9A-1½, 4G9-2, 4G9-2½

G9A-1½, G9-2, G9-2½

Dimensions with Screwed NPT Casing



Close Coupled Centrifugal Pumps



MODEL		HP	MOTOR FRAME SIZE	DISC NPT (in)	SUCT NPT (in)	DIMENSIONS IN INCHES													
1 Phase	3 Phase					A	AB	B	CP	D	DD	E	F	G	H	L	X	Y	
1750 & 1450 RPM																			
154G9-1½	3154G9-1½	1½	145JM	1½	2	7	8 ¹⁵ / ₁₆	6	17 ⁹ / ₁₆	3½	5 ¹³ / ₁₆	2¾	5	¾	1 ¹ / ₃₂	9¾	9	3 ¹ / ₁₆	
204G9-1½	-----	2	182JM			8¾	9 ⁷ / ₈	5¾	18	4½	5 ¹³ / ₁₆	3¾	4½	½	1 ³ / ₃₂	10½	9	3 ¹ / ₁₆	
-----	3204G9-1½	2	145JM			7	8 ¹⁵ / ₁₆	6	17 ⁹ / ₁₆	3½	5 ¹³ / ₁₆	2¾	5	¾	1 ¹ / ₃₂	9¾	9	3 ¹ / ₁₆	
304G9-1½	-----	3	184JM			8¾	9 ⁷ / ₈	6¾	19	4½	5 ¹³ / ₁₆	3¾	5½	½	1 ³ / ₃₂	10½	9	3 ¹ / ₁₆	
-----	3304G9-1½	3	182JM			8¾	9 ⁷ / ₈	5¾	18	4½	5 ¹³ / ₁₆	3¾	4½	½	1 ³ / ₃₂	10½	9	3 ¹ / ₁₆	
154G9-2	3154G9-2	1½	145JM	2	2½	7	8 ¹⁵ / ₁₆	6	18 ⁹ / ₁₆	3½	5 ¹³ / ₁₆	2¾	5	¾	1 ¹ / ₃₂	10 ⁷ / ₈	9 ⁵ / ₈	4	
204G9-2	-----	2	182JM			8¾	9 ⁷ / ₈	5¾	19¼	4½	5 ¹³ / ₁₆	3¾	4½	½	1 ³ / ₃₂	11 ⁵ / ₈	9 ⁵ / ₈	4	
-----	3204G9-2	2	145JM			7	8 ¹⁵ / ₁₆	6	18 ⁹ / ₁₆	3½	5 ¹³ / ₁₆	2¾	5	¾	1 ¹ / ₃₂	10 ⁷ / ₈	9 ⁵ / ₈	4	
304G9-2	-----	3	184JM			8¾	9 ⁷ / ₈	6¾	20¼	4½	5 ¹³ / ₁₆	3¾	5½	½	1 ³ / ₃₂	11 ⁵ / ₈	9 ⁵ / ₈	4	
-----	3304G9-2	3	182JM			8¾	9 ⁷ / ₈	5¾	19¼	4½	5 ¹³ / ₁₆	3¾	4½	½	1 ³ / ₃₂	11 ⁵ / ₈	9 ⁵ / ₈	4	
504G9-2	3504G9-2	5	184JM	8¾	9 ⁷ / ₈	6¾	20¼	4½	5 ¹³ / ₁₆	3¾	5½	½	1 ³ / ₃₂	11 ⁵ / ₈	9 ⁵ / ₈	4			
304G9-2½	-----	3	184JM	2½	3	8¾	9 ⁷ / ₈	6¾	19¾	4½	6 ¹ / ₁₆	3¾	5½	½	1 ³ / ₃₂	11¼	10½	3½	
-----	3304G9-2½	3	182JM			8¾	9 ⁷ / ₈	5¾	18¾	4½	6 ¹ / ₁₆	3¾	4½	½	1 ³ / ₃₂	11¼	10½	3½	
504G9-2½	3504G9-2½	5	184JM			8¾	9 ⁷ / ₈	6¾	19¾	4½	6 ¹ / ₁₆	3¾	5½	½	1 ³ / ₃₂	11¼	10½	3½	
-----	3754G9-2½	7½	215JM			10 ⁹ / ₁₆	11 ¹ / ₁₆	8¾	22 ¹¹ / ₁₆	5¼	6 ¹ / ₁₆	4¼	7	¾	1 ³ / ₃₂	12 ⁵ / ₈	10½	3½	
-----	3754G9-2½	7½	213JM			10 ⁹ / ₁₆	11 ¹ / ₁₆	7¼	21 ³ / ₁₆	5¼	6 ¹ / ₁₆	4¼	5½	¾	1 ³ / ₃₂	12 ⁵ / ₈	10½	3½	
3500 & 2900 RPM																			
-----	350G9-1½	5	182JM	1½	2	8¾	9 ⁷ / ₈	5¾	18	4½	5 ¹³ / ₁₆	3¾	4½	½	1 ³ / ₃₂	10½	9	3 ¹ / ₁₆	
-----	375G9-1½	7½	184JM			8¾	9 ⁷ / ₈	6¾	19	4½	5 ¹³ / ₁₆	3¾	5½	½	1 ³ / ₃₂	10½	9	3 ¹ / ₁₆	
-----	3100G9-1½	10	213JM			10 ⁹ / ₁₆	11 ¹ / ₁₆	7¼	20 ⁷ / ₁₆	5¼	5 ¹³ / ₁₆	4¼	5½	¾	1 ³ / ₃₂	11 ⁵ / ₈	9	3 ¹ / ₁₆	
-----	3150G9-1½	15	215JM			10 ⁹ / ₁₆	11 ¹ / ₁₆	8¾	21 ⁵ / ₁₆	5¼	5 ¹³ / ₁₆	4¼	7	¾	1 ³ / ₃₂	11 ⁵ / ₈	9	3 ¹ / ₁₆	
-----	3200G9-1½	20	254JM			12	11 ⁹ / ₁₆	10¼	25 ¹³ / ₁₆	6¼	5 ¹³ / ₁₆	5	8¼	7 ⁸ / ₁₆	1 ⁷ / ₃₂	13½	9	3 ¹ / ₁₆	
-----	3150G9-2	15	215JM	2	2½	10 ⁹ / ₁₆	11 ¹ / ₁₆	8¾	23 ¹ / ₁₆	5¼	5 ¹³ / ₁₆	4¼	7	¾	1 ³ / ₃₂	12¾	9 ⁵ / ₈	4	
-----	3200G9-2	20	254JM			12	11 ⁹ / ₁₆	10¼	26 ¹⁵ / ₁₆	6¼	5 ¹³ / ₁₆	5	8¼	7 ⁸ / ₁₆	1 ⁷ / ₃₂	14 ⁵ / ₈	9 ⁵ / ₈	4	
-----	3250G9-2	25	256JM			12	11 ⁹ / ₁₆	12	28 ¹¹ / ₁₆	6¼	5 ¹³ / ₁₆	5	10	7 ⁸ / ₁₆	1 ⁷ / ₃₂	14 ⁵ / ₈	9 ⁵ / ₈	4	
-----	3300G9-2	30	284JM			13¾	13	11½	28 ¹¹ / ₁₆	7	5 ¹³ / ₁₆	5½	9½	7 ⁸ / ₁₆	1 ⁷ / ₃₂	14 ⁵ / ₈	9 ⁵ / ₈	4	
-----	3400G9-2	40	286JM			13¾	13	13	30 ³ / ₁₆	7	5 ¹³ / ₁₆	5½	11	7 ⁸ / ₁₆	1 ⁷ / ₃₂	14 ⁵ / ₈	9 ⁵ / ₈	4	
-----	3250G9-2½	25	256JM	2½	3	12	11 ⁹ / ₁₆	12	28 ⁵ / ₁₆	6¼	6 ¹ / ₁₆	5	10	7 ⁸ / ₁₆	1 ⁷ / ₃₂	14¼	10½	3½	
-----	3300G9-2½	30	284JM			13¾	13	11½	28 ⁵ / ₁₆	7	6 ¹ / ₁₆	5½	9½	7 ⁸ / ₁₆	1 ⁷ / ₃₂	14¼	10½	3½	
-----	3400G9-2½	40	286JM			13¾	13	13	29 ¹³ / ₁₆	7	6 ¹ / ₁₆	5½	11	7 ⁸ / ₁₆	1 ⁷ / ₃₂	14¼	10½	3½	
-----	3500G9-2½	50	324JM			14½	16¼	12¼	30¾	8	6 ¹ / ₁₆	6¼	10½	7 ⁸ / ₁₆	2 ¹ / ₃₂	14¾	10½	3½	
-----	3600G9-2½	60	326JM			14½	16¼	13¾	31¾	8	6 ¹ / ₁₆	6¼	12	7 ⁸ / ₁₆	2 ¹ / ₃₂	14¾	10½	3½	

DIMENSIONS SHOWN ABOVE ARE APPROXIMATE MAXIMUM DIMENSIONS FOR STANDARD PUMPS EQUIPPED WITH ODP MOTORS.

SECTION 2B
PAGE 16
DATE 1/06



PUMPS & SYSTEMS

A Crane Co. Company

USA: (937) 778-8947 • Canada: (905) 457-6223 • International: (937) 615-3598

Close Coupled Centrifugal Pumps



DIMENSIONS IN MILLIMETERS																		
MODEL		HP	MOTOR FRAME SIZE	DISC NPT (in)	SUCT NPT (in)	A	AB	B	CP	D	DD	E	F	G	H	L	X	Y
1 Phase	3 Phase																	
1750 & 1450 RPM																		
154G9-1½	3154G9-1½	1½	145JM	1½	2	178	227	152	437	89	148	70	127	9.5	8.7	248	229	78
204G9-1½	-----	2	182JM			222	251	146	457	114	148	95	114	13	10.3	267	229	78
-----	3204G9-1½	2	145JM			178	227	152	437	89	148	70	127	9.5	8.7	248	229	78
304G9-1½	-----	3	184JM			222	251	172	483	114	148	95	140	13	10.3	267	229	78
-----	3304G9-1½	3	182JM			222	251	146	457	114	148	95	114	13	10.3	267	229	78
154G9-2	3154G9-2	1½	145JM	2	2½	178	227	152	465	89	151	70	127	9.5	8.7	276	244	102
204G9-2	-----	2	182JM			222	251	146	489	114	151	95	114	13	10.3	295	244	102
-----	3204G9-2	2	145JM			178	227	152	465	89	151	70	127	9.5	8.7	276	244	102
304G9-2	-----	3	184JM			222	251	172	514	114	151	95	140	13	10.3	295	244	102
-----	3304G9-2	3	182JM			222	251	146	489	114	151	95	114	13	10.3	295	244	102
504G9-2	3504G9-2	5	184JM			222	251	172	514	114	151	95	140	13	10.3	295	244	102
304G9-2½	-----	3	184JM	2½	3	222	251	172	502	114	154	95	140	13	10.3	286	267	89
-----	3304G9-2½	3	182JM			222	251	146	476	114	154	95	114	13	10.3	286	267	89
504G9-2½	3504G9-2½	5	184JM			222	251	172	502	114	154	95	140	13	10.3	286	267	89
754G9-2½	-----	7½	215JM			264	281	222	576	133	154	108	178	16	10.3	314	267	89
-----	3754G9-2½	7½	213JM			264	281	184	538	133	154	108	140	16	10.3	314	267	89
3500 & 2900 RPM																		
-----	350G9-1½	5	182JM	1½	2	222	251	146	457	114	148	95	114	13	10.3	267	229	78
-----	375G9-1½	7½	184JM			222	251	172	483	114	148	95	140	13	10.3	267	229	78
-----	3100G9-1½	10	213JM			264	281	184	519	133	148	108	140	16	10.3	295	229	78
-----	3150G9-1½	15	215JM			264	281	222	557	133	148	108	178	16	10.3	295	229	78
-----	3200G9-1½	20	254JM			305	294	260	656	159	148	127	210	22	13.5	343	229	78
-----	3150G9-2	15	215JM	2	2½	264	281	222	586	133	151	108	178	16	10.3	324	244	102
-----	3200G9-2	20	254JM			305	294	260	684	159	151	127	210	22	13.5	372	244	102
-----	3250G9-2	25	256JM			305	294	305	729	159	151	127	254	22	13.5	372	244	102
-----	3300G9-2	30	284JM			349	330	292	729	178	151	140	241	22	13.5	372	244	102
-----	3400G9-2	40	286JM			349	330	330	767	178	151	140	279	22	13.5	372	244	102
-----	3250G9-2½	25	256JM	2½	3	305	294	305	719	159	154	127	254	22	13.5	362	267	89
-----	3300G9-2½	30	284JM			349	330	292	719	178	154	140	241	22	13.5	362	267	89
-----	3400G9-2½	40	286JM			349	330	330	757	178	154	140	279	22	13.5	362	267	89
-----	3500G9-2½	50	324JM			368	413	311	768	203	154	159	267	22	16.7	375	267	89
-----	3600G9-2½	60	326JM			368	413	349	806	203	154	159	305	22	16.7	375	267	89

DIMENSIONS SHOWN ABOVE ARE APPROXIMATE MAXIMUM DIMENSIONS FOR STANDARD PUMPS EQUIPPED WITH ODP MOTORS.

Series: G6-2F, G6-2½F,
G7-2F, G7A-2F, G7-2½F
Dimensions with Flanged Casing



Close Coupled Centrifugal Pumps



DIMENSIONS IN INCHES

MODEL	MOTOR FRAME SIZE	DISC NPT (in)	SUCT NPT (in)	A	AB	B	CP	D	DD	E	F	G	H	L	O	X	Y
G6-2F	56	2	2½	5	---	8	15 ¹³ / ₁₆	5 ⁵ / ₁₆	4½	1 ¹⁵ / ₁₆	---	¼	9 ¹ / ₁₆	7 ⁷ / ₈	6 ¹¹ / ₁₆	6	2½
	143JM			7	8 ¹⁵ / ₁₆	5	15 ¹⁵ / ₁₆	3½	4½	2¾	2	¾	1 ¹ / ₃₂	8 ⁷ / ₈	7 ³ / ₁₆	6	2½
	145JM			7	8 ¹⁵ / ₁₆	6	16 ¹⁶ / ₁₆	3½	4½	2¾	2½	¾	1 ¹ / ₃₂	8 ⁷ / ₈	7 ³ / ₁₆	6	2½
	182JM			8¾	9 ⁷ / ₈	5¾	17 ⁷ / ₈	4½	4½	3¾	2¼	½	1 ³ / ₃₂	9 ⁹ / ₈	9 ¹¹ / ₁₆	6	2½
	184JM			8¾	9 ⁷ / ₈	6¾	18 ⁸ / ₈	4½	4½	3¾	2¾	½	1 ³ / ₃₂	9 ⁹ / ₈	9 ¹¹ / ₁₆	6	2½
	213JM			10 ¹⁰ / ₈	11 ¹¹ / ₁₆	7¼	19 ¹¹ / ₁₆	5¼	4½	4¼	2¾	5 ⁵ / ₈	1 ³ / ₃₂	10 ¹⁰ / ₈	11	6	2½
	215JM			10 ¹⁰ / ₈	11 ¹¹ / ₁₆	8¾	21 ¹⁶ / ₁₆	5¼	4½	4¼	3½	5 ⁵ / ₈	1 ³ / ₃₂	10 ¹⁰ / ₈	11	6	2½
G6-2½F	143JM	2½	3	7	8 ¹⁵ / ₁₆	5	15 ³ / ₄	3½	5	2¾	2	¾	1 ¹ / ₃₂	9 ⁹ / ₁₆	7 ³ / ₁₆	6½	2½
	145JM			7	8 ¹⁵ / ₁₆	6	16 ³ / ₄	3½	5	2¾	2½	¾	1 ¹ / ₃₂	9 ⁹ / ₁₆	7 ³ / ₁₆	6½	2½
	182JM			8¾	9 ⁷ / ₈	5¾	17 ⁷ / ₁₆	4½	5	3¾	2¼	½	1 ³ / ₃₂	10 ¹⁰ / ₁₆	9 ⁹ / ₁₆	6½	2½
	184JM			8¾	9 ⁷ / ₈	6¾	18 ⁸ / ₁₆	4½	5	3¾	2¾	½	1 ³ / ₃₂	10 ¹⁰ / ₁₆	9 ⁹ / ₁₆	6½	2½
	213JM			10 ¹⁰ / ₈	11 ¹¹ / ₁₆	7¼	20 ⁸ / ₈	5¼	5	4¼	2¾	5 ⁵ / ₈	1 ³ / ₃₂	11 ¹¹ / ₁₆	11	6½	2½
	215JM			10 ¹⁰ / ₈	11 ¹¹ / ₁₆	8¾	21 ² / ₂	5¼	5	4¼	3½	5 ⁵ / ₈	1 ³ / ₃₂	11 ¹¹ / ₁₆	11	6½	2½
	254JM			12 ² / ₈	11 ⁹ / ₁₆	10¼	25	6¼	5	5	4½	7 ⁷ / ₈	1 ⁷ / ₃₂	12 ¹¹ / ₁₆	13 ³ / ₁₆	6½	2½
256JM	12 ² / ₈	11 ⁹ / ₁₆	12¼	26 ³ / ₄	6¼	5	5	5	7 ⁷ / ₈	1 ⁷ / ₃₂	12 ¹¹ / ₁₆	13 ³ / ₁₆	6½	2½			
G7-2F G7A-2F	143JM	2	2½	7	8 ¹⁵ / ₁₆	5	15 ¹⁵ / ₁₆	3½	5	2¾	2	¾	1 ¹ / ₃₂	9 ⁹ / ₈	7 ³ / ₁₆	6¾	2 ¹ / ₁₆
	145JM			7	8 ¹⁵ / ₁₆	6	16 ¹⁶ / ₁₆	3½	5	2¾	2½	¾	1 ¹ / ₃₂	9 ⁹ / ₈	7 ³ / ₁₆	6¾	2 ¹ / ₁₆
	182JM			8¾	9 ⁷ / ₈	5¾	17 ⁷ / ₈	4½	5	3¾	2¼	½	1 ³ / ₃₂	9 ⁹ / ₈	9 ⁹ / ₁₆	6¾	2 ¹ / ₁₆
	184JM			8¾	9 ⁷ / ₈	6¾	18 ⁸ / ₈	4½	5	3¾	2¾	½	1 ³ / ₃₂	9 ⁹ / ₈	9 ⁹ / ₁₆	6¾	2 ¹ / ₁₆
	213JM			10 ¹⁰ / ₈	11 ¹¹ / ₁₆	7¼	19 ¹⁵ / ₁₆	5¼	5	4¼	2¾	5 ⁵ / ₈	1 ³ / ₃₂	11	11	6¾	2 ¹ / ₁₆
	215JM			10 ¹⁰ / ₈	11 ¹¹ / ₁₆	8¾	21 ¹⁵ / ₁₆	5¼	5	4¼	3½	5 ⁵ / ₈	1 ³ / ₃₂	11	11	6¾	2 ¹ / ₁₆
	354JM			12 ¹² / ₈	11 ⁹ / ₁₆	10¼	24 ⁷ / ₈	6¼	5	5	4½	7 ⁷ / ₈	1 ⁷ / ₃₂	12 ² / ₁₆	13 ³ / ₁₆	6¾	2 ¹ / ₁₆
256JM	12 ¹² / ₈	11 ⁹ / ₁₆	12¼	26 ⁸ / ₈	6¼	5	5	5	7 ⁷ / ₈	1 ⁷ / ₃₂	12 ² / ₁₆	13 ³ / ₁₆	6¾	2 ¹ / ₁₆			
G7-2½F	143JM	2½	3	7	8 ¹⁵ / ₁₆	5	15 ³ / ₄	3½	5½	2¾	2	¾	1 ¹ / ₃₂	9 ⁹ / ₁₆	7 ³ / ₁₆	7½	2½
	145JM			7	8 ¹⁵ / ₁₆	6	16 ³ / ₄	3½	5½	2¾	2½	¾	1 ¹ / ₃₂	9 ⁹ / ₁₆	7 ³ / ₁₆	7½	2½
	182JM			8¾	9 ⁷ / ₈	5¾	17 ⁷ / ₁₆	4½	5½	3¾	2¼	½	1 ³ / ₃₂	10 ¹⁰ / ₁₆	9 ⁹ / ₁₆	7½	2½
	184JM			8¾	9 ⁷ / ₈	6¾	18 ⁸ / ₁₆	4½	5½	3¾	2¾	½	1 ³ / ₃₂	10 ¹⁰ / ₁₆	9 ⁹ / ₁₆	7½	2½
	213JM			10 ¹⁰ / ₈	11 ¹¹ / ₁₆	7¼	19 ¹⁵ / ₁₆	5¼	5½	4¼	2¾	5 ⁵ / ₈	1 ³ / ₃₂	11 ¹¹ / ₁₆	11	7½	2½
	215JM			10 ¹⁰ / ₈	11 ¹¹ / ₁₆	8¾	21 ² / ₂	5¼	5½	4¼	3½	5 ⁵ / ₈	1 ³ / ₃₂	11 ¹¹ / ₁₆	11	7½	2½
	254JM			12 ¹² / ₈	11 ⁹ / ₁₆	10¼	25 ¹⁵ / ₁₆	6¼	5½	5	4½	7 ⁷ / ₈	1 ⁷ / ₃₂	12 ³ / ₄	13 ³ / ₁₆	7½	2½
	256JM			12 ¹² / ₈	11 ⁹ / ₁₆	12¼	26 ¹³ / ₁₆	6¼	5½	5	5	7 ⁷ / ₈	1 ⁷ / ₃₂	12 ³ / ₄	13 ³ / ₁₆	7½	2½
	284JM			13 ³ / ₄	13	11½	26 ¹³ / ₁₆	7	5½	5½	4¾	7 ⁷ / ₈	1 ⁷ / ₃₂	12 ³ / ₄	14 ³ / ₄	7½	2½
	286JM			13 ³ / ₄	13	13	28 ⁵ / ₁₆	7	5½	5½	5½	7 ⁷ / ₈	1 ⁷ / ₃₂	12 ³ / ₄	14 ³ / ₄	7½	2½
	324JM			14½	16¼	12¼	28 ³ / ₄	8	5½	6¼	5¼	7 ⁷ / ₈	2 ¹ / ₃₂	13 ³ / ₄	17 ¹ / ₈	7½	2½
	326JM			14½	16¼	13¾	30 ³ / ₄	8	5½	6¼	6	7 ⁷ / ₈	2 ¹ / ₃₂	13 ³ / ₄	17 ¹ / ₈	7½	2½

DIMENSIONS SHOWN ABOVE ARE APPROXIMATE MAXIMUM DIMENSIONS FOR STANDARD PUMPS EQUIPPED WITH ODP MOTORS.

SECTION 2B
PAGE 18
DATE 1/06



PUMPS & SYSTEMS

A Crane Co. Company

USA: (937) 778-8947 • Canada: (905) 457-6223 • International: (937) 615-3598

Close Coupled Centrifugal Pumps



DIMENSIONS IN MILLIMETERS

MODEL	MOTOR FRAME SIZE	DISC NPT (in)	SUCT NPT (in)	A	AB	B	CP	D	DD	E	F	G	H	L	O	X	Y
G6-2F	56	2	2½	127	---	203	402	135	114	49	---	6.4	14.3	200	170	152	54
	143JM			178	227	127	389	89	114	70	51	9.5	8.7	225	183	152	54
	145JM			178	227	152	414	89	114	70	64	9.5	8.7	225	183	152	54
	182JM			222	251	146	435	114	114	95	57	13	10.3	244	246	152	54
	184JM			222	251	172	460	114	114	95	70	13	10.3	244	246	152	54
	213JM			264	281	184	500	133	114	108	70	16	10.3	273	279	152	54
	215JM			264	281	222	535	133	114	108	89	16	10.3	273	279	152	54
G6-2½F	143JM	2½	3	178	227	127	400	89	127	70	51	9.5	8.7	237	183	165	60
	145JM			178	227	152	425	89	127	70	64	9.5	8.7	237	183	165	60
	182JM			222	251	146	446	114	127	95	57	13	10.3	256	246	165	60
	184JM			222	251	172	472	114	127	95	70	13	10.3	256	246	165	60
	213JM			264	281	184	511	133	127	108	70	16	10.3	284	279	165	60
	215JM			264	281	222	546	133	127	108	89	16	10.3	284	279	165	60
	254JM			314	294	260	635	159	127	127	105	22	13.5	322	335	165	60
	256JM			314	294	311	679	159	127	127	127	22	13.5	322	335	165	60
G7-2F G7A-2F	143JM	2	2½	178	227	127	395	89	127	70	51	9.5	8.7	232	183	172	62
	145JM			178	227	152	421	89	127	70	64	9.5	8.7	232	183	172	62
	182JM			222	251	146	441	114	127	95	57	13	10.3	251	246	172	62
	184JM			222	251	172	467	114	127	95	70	13	10.3	251	246	172	62
	213JM			264	281	184	506	133	127	108	70	16	10.3	279	279	172	62
	215JM			264	281	222	541	133	127	108	89	16	10.3	279	279	172	62
	354JM			314	294	260	632	159	127	127	105	22	13.5	319	335	172	62
	256JM			314	294	311	676	159	127	127	127	22	13.5	319	335	172	62
G7-2½F	143JM	2½	3	178	227	127	400	89	140	70	51	9.5	8.7	237	183	191	60
	145JM			178	227	152	426	89	140	70	64	9.5	8.7	237	183	191	60
	182JM			222	251	146	446	114	140	95	57	13	10.3	256	246	191	60
	184JM			222	251	172	472	114	140	95	70	13	10.3	256	246	191	60
	213JM			264	281	184	506	133	140	108	70	16	10.3	284	279	191	60
	215JM			264	281	222	546	133	140	108	89	16	10.3	284	279	191	60
	254JM			314	294	260	637	159	140	127	105	22	13.5	324	335	191	60
	256JM			314	294	311	681	159	140	127	127	22	13.5	324	335	191	60
	284JM			349	330	292	681	178	140	140	121	22	13.5	324	375	191	60
	286JM			349	330	330	719	178	140	140	140	22	13.5	324	375	191	60
	324JM			368	413	311	730	203	140	159	133	22	17	337	435	191	60
	326JM			368	413	349	768	203	140	159	152	22	17	337	435	191	60

DIMENSIONS SHOWN ABOVE ARE APPROXIMATE MAXIMUM DIMENSIONS FOR STANDARD PUMPS EQUIPPED WITH ODP MOTORS.

Close Coupled Centrifugal Pumps



DIMENSIONS IN INCHES

MODEL	MOTOR FRAME SIZE	DISC NPT (in)	SUCT NPT (in)	A	AB	B	CP	D	DD	E	F	G	H	L	O	X	Y
G9-2F	143JM	2	2½	7	8 ¹⁵ / ₁₆	5	15 ⁷ / ₈	3½	5 ¹⁵ / ₁₆	2¾	2	¾	1 ¹¹ / ₃₂	9 ¹ / ₁₆	7 ³ / ₁₆	8½	2 ⁵ / ₁₆
	145JM			7	8 ⁸ / ₁₆	6	16 ⁷ / ₈	3½	5 ¹⁵ / ₁₆	2¾	2½	¾	1 ¹¹ / ₃₂	9 ¹ / ₁₆	7 ³ / ₁₆	8½	2 ⁵ / ₁₆
	182JM			8¾	9 ⁷ / ₈	5¾	17 ¹³ / ₁₆	4½	5 ¹⁵ / ₁₆	3¾	2¼	½	1 ¹³ / ₃₂	10 ³ / ₁₆	9 ¹ / ₁₆	8½	2 ⁵ / ₁₆
	184JM			8¾	9 ⁷ / ₈	6¾	18 ¹³ / ₁₆	4½	5 ¹⁵ / ₁₆	3¾	2¼	½	1 ¹³ / ₃₂	10 ³ / ₁₆	9 ¹ / ₁₆	8½	2 ⁵ / ₁₆
	213JM			10 ⁹ / ₁₆	11 ¹ / ₁₆	7¼	20 ⁹ / ₁₆	5¼	5 ¹⁵ / ₁₆	4¼	2¾	5 ⁵ / ₈	1 ¹³ / ₃₂	11 ⁵ / ₁₆	11	8½	2 ⁵ / ₁₆
	215JM			10 ⁹ / ₁₆	11 ¹ / ₁₆	8¾	21 ⁵ / ₈	5¼	5 ¹⁵ / ₁₆	4¼	3½	5 ⁵ / ₈	1 ¹³ / ₃₂	11 ⁵ / ₁₆	11	8½	2 ⁵ / ₁₆
	254JM			12 ³ / ₈	11 ⁹ / ₁₆	10¼	25½	6¼	5 ¹⁵ / ₁₆	5	4½	7 ⁵ / ₈	1 ¹⁷ / ₃₂	13 ³ / ₁₆	13 ³ / ₁₆	8½	2 ⁵ / ₁₆
	256JM			12 ³ / ₈	11 ⁹ / ₁₆	12¼	27¼	6¼	5 ¹⁵ / ₁₆	5	5	7 ⁵ / ₈	1 ¹⁷ / ₃₂	13 ³ / ₁₆	13 ³ / ₁₆	8½	2 ⁵ / ₁₆
	284JM			13¾	13	11½	27¼	7	5 ¹⁵ / ₁₆	5½	4¾	7 ⁵ / ₈	1 ¹⁷ / ₃₂	13 ³ / ₁₆	14¾	8½	2 ⁵ / ₁₆
	286JM			13¾	13	13	28¾	7	5 ¹⁵ / ₁₆	5½	5½	7 ⁵ / ₈	1 ¹⁷ / ₃₂	13 ³ / ₁₆	14¾	8½	2 ⁵ / ₁₆
	324JM			14½	16¼	12¼	29 ⁹ / ₁₆	8	5 ¹⁵ / ₁₆	6¼	5¼	7 ⁵ / ₈	2 ¹ / ₃₂	13 ¹¹ / ₁₆	17 ¹ / ₈	8½	2 ⁵ / ₁₆
	326JM			14½	16¼	13¾	30 ¹¹ / ₁₆	8	5 ¹⁵ / ₁₆	6¼	6	7 ⁵ / ₈	2 ¹ / ₃₂	13 ¹¹ / ₁₆	17 ¹ / ₈	8½	2 ⁵ / ₁₆
G9-2½F	143JM	2½	3	7	8 ⁸ / ₁₆	5	16 ¹ / ₁₆	3½	6 ¹ / ₁₆	2¾	2	¾	1 ¹¹ / ₃₂	9 ⁵ / ₁₆	7 ³ / ₁₆	9¼	2 ⁵ / ₁₆
	145JM			7	8 ⁸ / ₁₆	6	17 ¹ / ₁₆	3½	6 ¹ / ₁₆	2¾	2½	¾	1 ¹¹ / ₃₂	9 ⁵ / ₁₆	7 ³ / ₁₆	9¼	2 ⁵ / ₁₆
	182JM			8¾	9 ⁷ / ₈	5¾	17 ⁷ / ₈	4½	6 ¹ / ₁₆	3¾	2¼	½	1 ¹³ / ₃₂	10 ³ / ₁₆	9 ¹ / ₁₆	9¼	2 ⁵ / ₁₆
	184JM			8¾	9 ⁷ / ₈	6¾	18 ⁷ / ₈	4½	6 ¹ / ₁₆	3¾	2¼	½	1 ¹³ / ₃₂	10 ³ / ₁₆	9 ¹ / ₁₆	9¼	2 ⁵ / ₁₆
	213JM			10 ⁹ / ₁₆	11 ¹ / ₁₆	7¼	20 ⁹ / ₁₆	5¼	6 ¹ / ₁₆	4¼	2¾	5 ⁵ / ₈	1 ¹³ / ₃₂	11½	11	9¼	2 ⁵ / ₁₆
	215JM			10 ⁹ / ₁₆	11 ¹ / ₁₆	8¾	21 ³ / ₁₆	5¼	6 ¹ / ₁₆	4¼	3½	5 ⁵ / ₈	1 ¹³ / ₃₂	11½	11	9¼	2 ⁵ / ₁₆
	254JM			12 ³ / ₈	11 ⁹ / ₁₆	10¼	25 ¹¹ / ₁₆	6¼	6 ¹ / ₁₆	5	4½	7 ⁵ / ₈	1 ¹⁷ / ₃₂	13 ³ / ₁₆	13 ³ / ₁₆	9¼	2 ⁵ / ₁₆
	256JM			12 ³ / ₈	11 ⁹ / ₁₆	12¼	27 ⁷ / ₁₆	6¼	6 ¹ / ₁₆	5	5	7 ⁵ / ₈	1 ¹⁷ / ₃₂	13 ³ / ₁₆	13 ³ / ₁₆	9¼	2 ⁵ / ₁₆
	284JM			13¾	13	11½	27 ¹ / ₁₆	7	6 ¹ / ₁₆	5½	4¾	7 ⁵ / ₈	1 ¹⁷ / ₃₂	13 ³ / ₁₆	14¾	9¼	2 ⁵ / ₁₆
	286JM			13¾	13	13	28 ⁵ / ₁₆	7	6 ¹ / ₁₆	5½	5½	7 ⁵ / ₈	1 ¹⁷ / ₃₂	13 ³ / ₁₆	14¾	9¼	2 ⁵ / ₁₆
	324JM			14½	16¼	12¼	29 ⁹ / ₁₆	8	6 ¹ / ₁₆	6¼	5¼	7 ⁵ / ₈	2 ¹ / ₃₂	13 ⁷ / ₁₆	17 ¹ / ₈	9¼	2 ⁵ / ₁₆
	326JM			14½	16¼	13¾	30 ⁷ / ₈	8	6 ¹ / ₁₆	6¼	6	7 ⁵ / ₈	2 ¹ / ₃₂	13 ⁷ / ₁₆	17 ¹ / ₈	9¼	2 ⁵ / ₁₆
G9-3F G9A-3F	182JM	3	4	8¾	9 ⁷ / ₈	5¾	18 ⁷ / ₁₆	4½	6¼	3¾	2¼	½	1 ¹³ / ₃₂	11	9 ¹ / ₁₆	9	2 ¹¹ / ₁₆
	184JM			8¾	9 ⁷ / ₈	6¾	19 ⁷ / ₁₆	4½	6¼	3¾	2¾	½	1 ¹³ / ₃₂	11	9 ¹ / ₁₆	9	2 ¹¹ / ₁₆
	213JM			10 ⁹ / ₁₆	11 ¹ / ₁₆	7¼	20¾	5¼	6¼	4¼	2¾	5 ⁵ / ₈	1 ¹³ / ₃₂	11 ⁷ / ₈	11	9	2 ¹¹ / ₁₆
	215JM			10 ⁹ / ₁₆	11 ¹ / ₁₆	8¾	22¼	5¼	6¼	4¼	3½	5 ⁵ / ₈	1 ¹³ / ₃₂	11 ⁷ / ₈	11	9	2 ¹¹ / ₁₆
	284JM			13¾	13	11½	27 ⁷ / ₈	7	6¼	5½	4¾	7 ⁵ / ₈	1 ¹⁷ / ₃₂	13 ³ / ₁₆	14¾	9	2 ¹¹ / ₁₆
	286JM			13¾	13	13	29 ⁹ / ₈	7	6¼	5½	5½	7 ⁵ / ₈	1 ¹⁷ / ₃₂	13 ³ / ₁₆	14¾	9	2 ¹¹ / ₁₆
	324JM			14½	16¼	12¼	29 ¹³ / ₁₆	8	6¼	6¼	5¼	7 ⁵ / ₈	2 ¹ / ₃₂	14 ⁵ / ₁₆	17 ¹ / ₈	9	2 ¹¹ / ₁₆
	326JM			14½	16¼	13¾	31 ⁵ / ₁₆	8	6¼	6¼	6	7 ⁵ / ₈	2 ¹ / ₃₂	14 ⁵ / ₁₆	17 ¹ / ₈	9	2 ¹¹ / ₁₆
4G9-4F	182JM	4	5	8¾	9 ¹¹ / ₁₆	5¾	19½	4½	7 ⁷ / ₁₆	3¾	2¼	½	1 ¹³ / ₃₂	11¾	9 ¹¹ / ₁₆	10 ⁵ / ₈	3¼
	184JM			8¾	9 ¹¹ / ₁₆	6¾	21½	4½	7 ⁷ / ₁₆	3¾	2¾	½	1 ¹³ / ₃₂	11¾	9 ¹¹ / ₁₆	10 ⁵ / ₈	3¼
	213JM			10 ⁹ / ₁₆	10 ⁷ / ₈	7¾	21 ⁵ / ₁₆	5¼	7 ⁷ / ₁₆	4¼	2¾	5 ⁵ / ₈	1 ¹³ / ₃₂	12 ³ / ₈	11	10 ⁵ / ₈	3¼
	215JM			10 ⁹ / ₁₆	10 ⁷ / ₈	8¾	23 ⁷ / ₁₆	5¼	7 ⁷ / ₁₆	4¼	3½	5 ⁵ / ₈	1 ¹³ / ₃₂	12 ³ / ₈	11	10 ⁵ / ₈	3¼

DIMENSIONS SHOWN ABOVE ARE APPROXIMATE MAXIMUM DIMENSIONS FOR STANDARD PUMPS EQUIPPED WITH ODP MOTORS.

Close Coupled Centrifugal Pumps



DIMENSIONS IN MILLIMETERS

MODEL	MOTOR FRAME SIZE	DISC NPT (in)	SUCT NPT (in)	A	AB	B	CP	D	DD	E	F	G	H	L	O	X	Y
G9-2F	143JM	2	2½	178	227	127	403	89	151	70	51	9.5	8.7	240	183	216	65
	145JM			178	227	152	429	89	151	70	64	9.5	8.7	240	183	216	65
	182JM			222	251	146	452	114	151	95	57	13	10.3	259	246	216	65
	184JM			222	251	172	478	114	151	95	70	13	10.3	259	246	216	65
	213JM			264	281	184	511	133	151	108	70	16	10.3	287	279	216	65
	215JM			264	281	222	549	133	151	108	89	16	10.3	287	279	216	65
	254JM			314	294	260	648	159	151	127	105	22	13.5	335	335	216	65
	256JM			314	294	311	692	159	151	127	127	22	13.5	335	335	216	65
	284JM			349	330	292	692	178	151	140	121	22	13.5	335	375	216	65
	286JM			349	330	330	730	178	151	140	140	22	13.5	335	375	216	65
	324JM			368	413	311	741	203	151	159	133	22	17	348	435	216	65
	326JM			368	413	349	779	203	151	159	152	22	17	348	435	216	65
G9-2½F	143JM	2½	3	178	227	127	408	89	154	70	51	9.5	8.7	245	183	235	65
	145JM			178	227	152	433	89	154	70	64	9.5	8.7	245	183	235	65
	182JM			222	251	146	454	114	154	95	57	13	10.3	264	246	235	65
	184JM			222	251	172	479	114	154	95	70	13	10.3	264	246	235	65
	213JM			264	281	184	516	133	154	108	70	16	10.3	292	279	235	65
	215JM			264	281	222	554	133	154	108	89	16	10.3	292	279	235	65
	254JM			314	294	260	653	159	154	127	105	22	13.5	340	335	235	65
	256JM			314	294	311	697	159	154	127	127	22	13.5	340	335	235	65
	284JM			349	330	292	697	178	154	140	121	22	13.5	340	375	235	65
	286JM			349	330	330	735	178	154	140	140	22	13.5	340	375	235	65
	324JM			368	413	311	746	203	154	159	133	22	17	352	435	235	65
	326JM			368	413	349	784	203	154	159	152	22	17	352	435	235	65
G9-3F G9A-3F	182JM	3	4	222	251	146	468	114	159	95	57	13	10.3	279	246	229	68
	184JM			222	251	172	494	114	159	95	70	13	10.3	279	246	229	68
	213JM			264	281	184	527	133	159	108	70	16	10.3	302	279	229	68
	215JM			264	281	222	565	133	159	108	89	16	10.3	302	279	229	68
	284JM			349	330	292	708	178	159	140	121	22	13.5	351	375	229	68
	286JM			349	330	330	746	178	159	140	140	22	13.5	351	375	229	68
	324JM			368	413	311	757	203	159	159	133	22	17	364	435	229	68
	326JM			368	413	349	795	203	159	159	152	22	17	364	435	229	68
4G9-4F	182JM	4	5	222	246	146	495	114	192	95	57	13	10.3	299	246	270	83
	184JM			222	246	172	546	114	192	95	70	13	10.3	299	246	270	83
	213JM			264	276	197	557	133	192	108	70	16	10.3	321	279	270	83
	215JM			264	276	222	595	133	192	108	89	16	10.3	321	279	270	83

DIMENSIONS SHOWN ABOVE ARE APPROXIMATE MAXIMUM DIMENSIONS FOR STANDARD PUMPS EQUIPPED WITH ODP MOTORS.

Close Coupled Centrifugal Pumps



Close Coupled Centrifugal Pumps

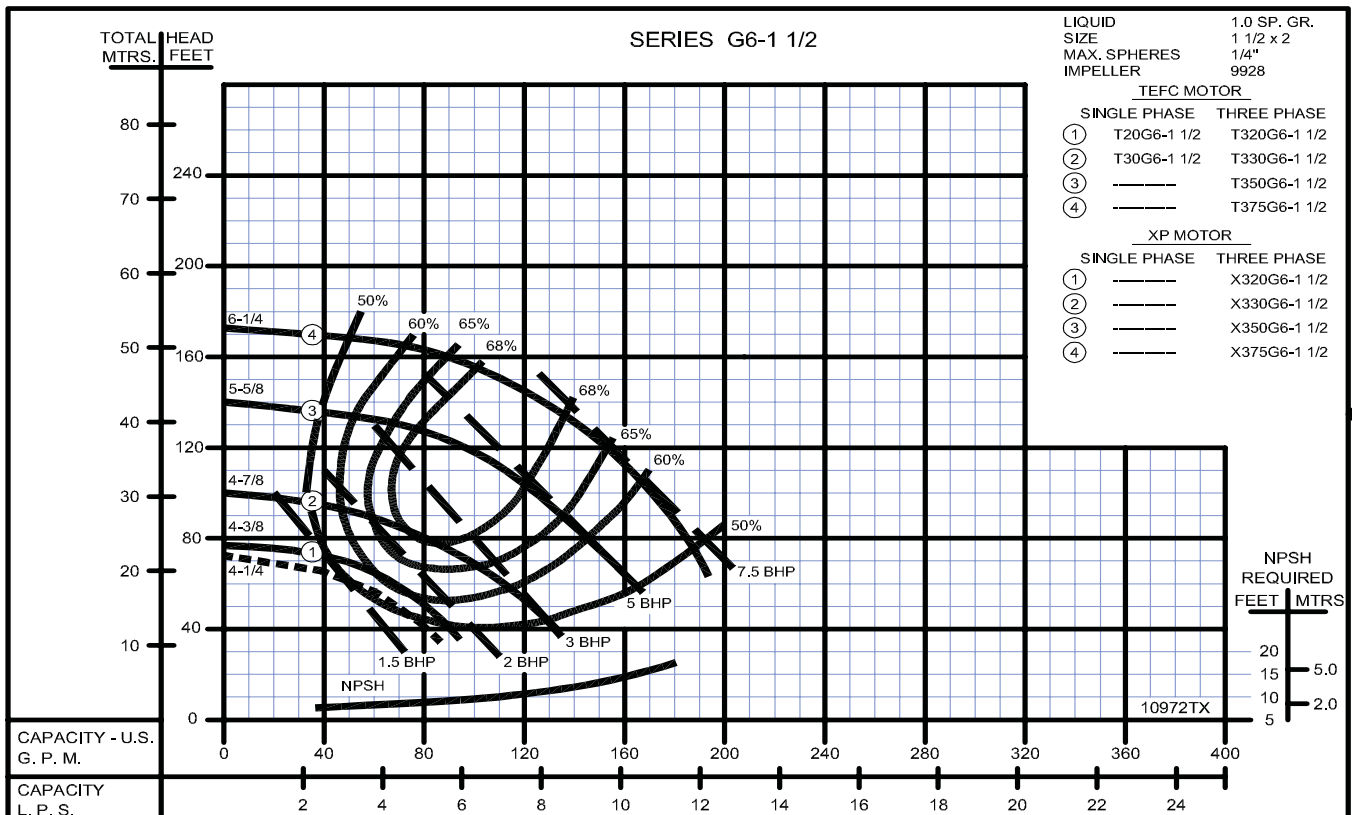
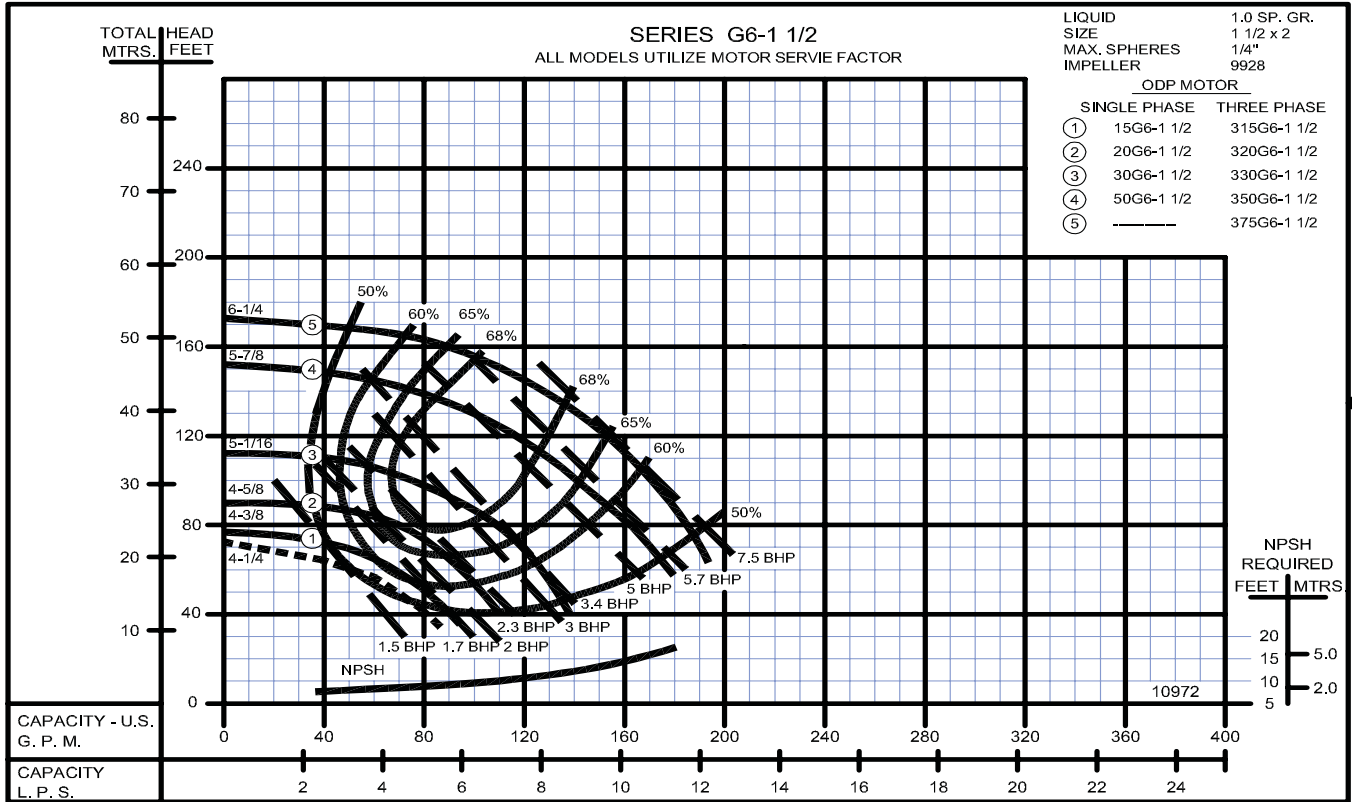

Close Coupled Centrifugal Pumps



Close Coupled Centrifugal Pumps

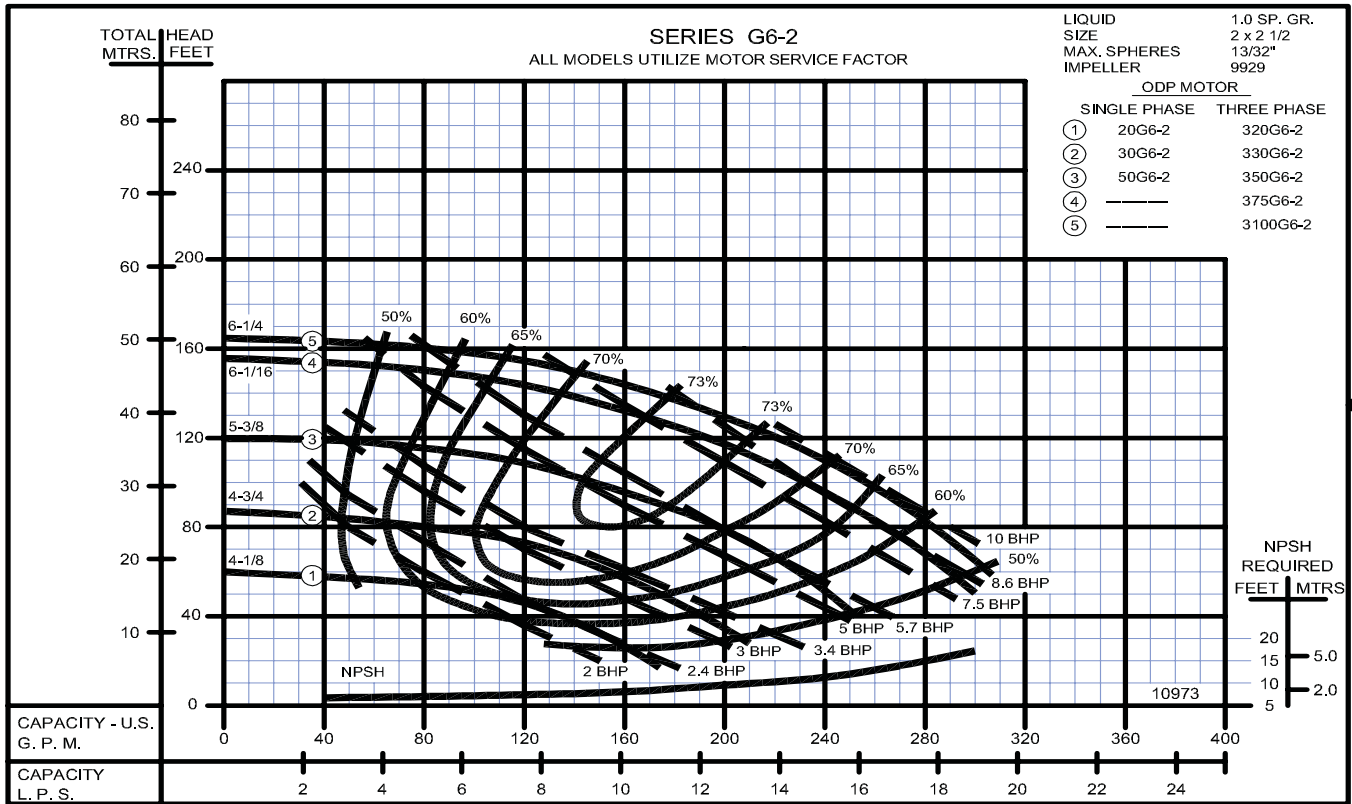

Close Coupled Centrifugal Pumps



Close Coupled Centrifugal Pumps

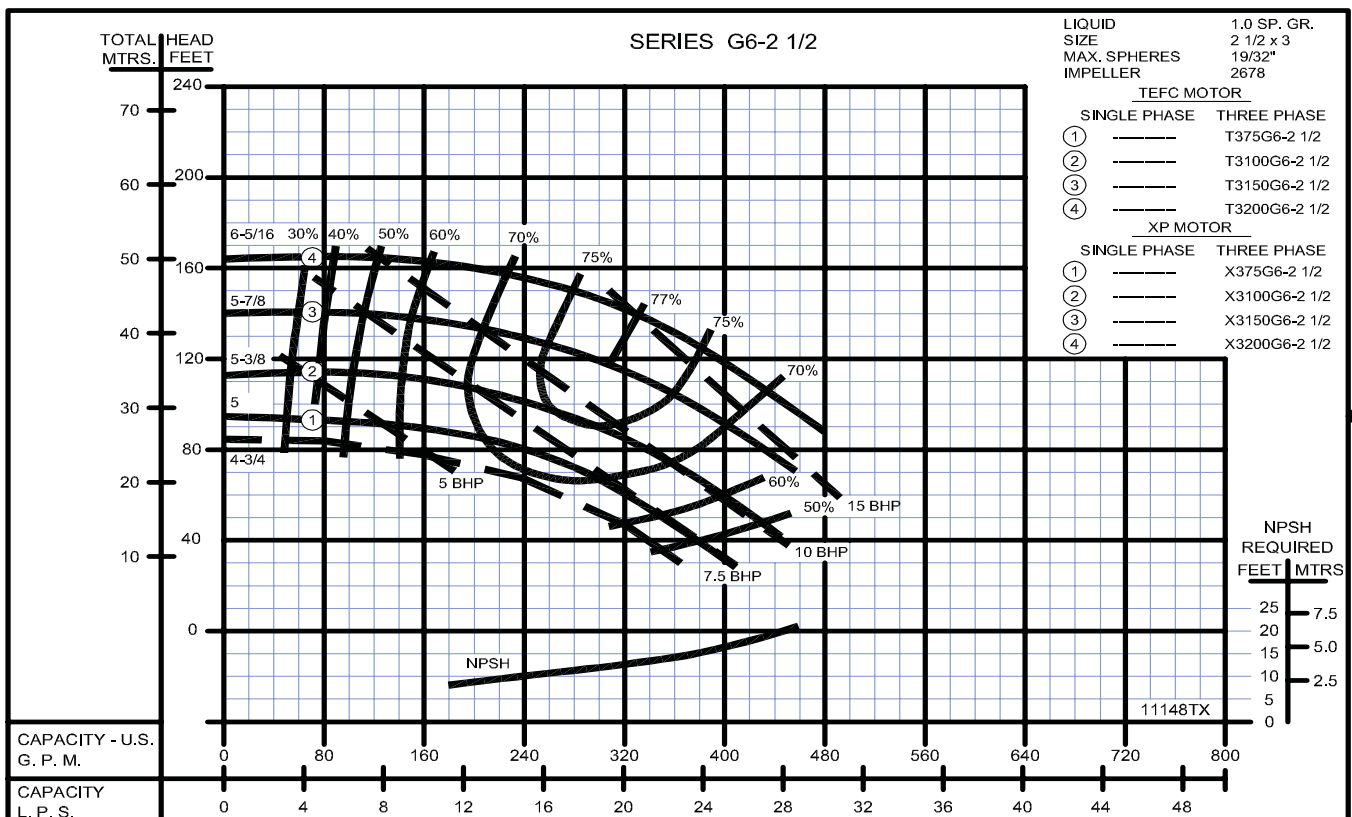
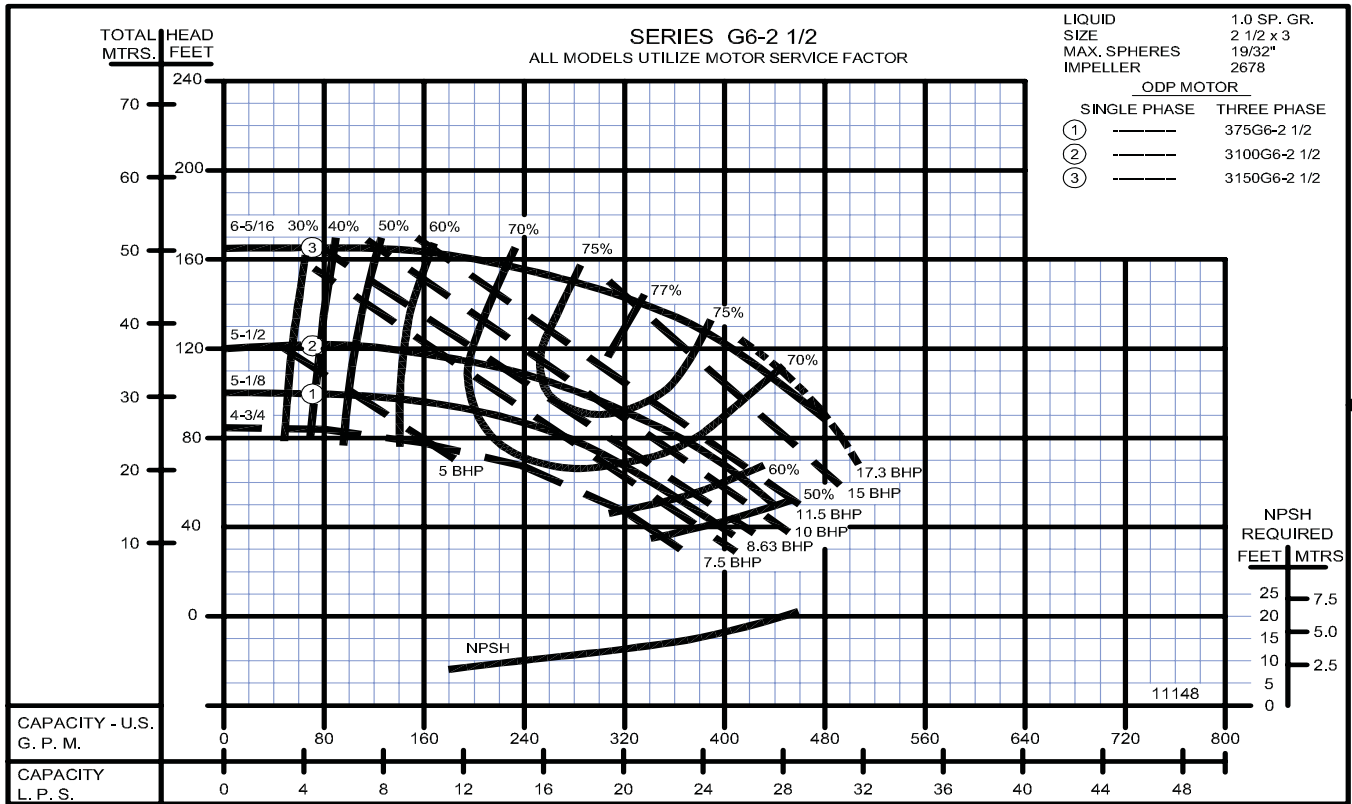

Close Coupled Centrifugal Pumps



Close Coupled Centrifugal Pumps



Close Coupled Centrifugal Pumps



Close Coupled Centrifugal Pumps



Close Coupled Centrifugal Pumps



Close Coupled Centrifugal Pumps

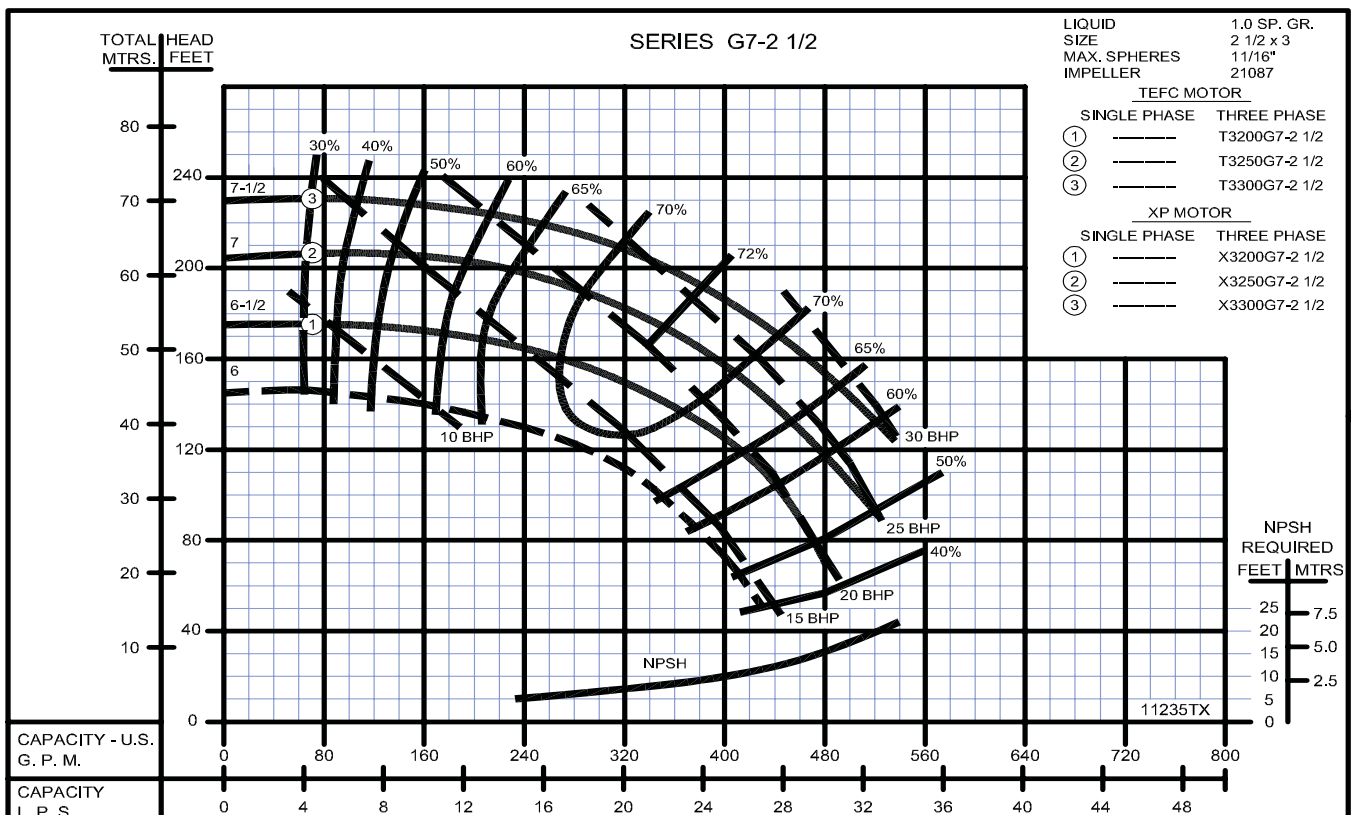
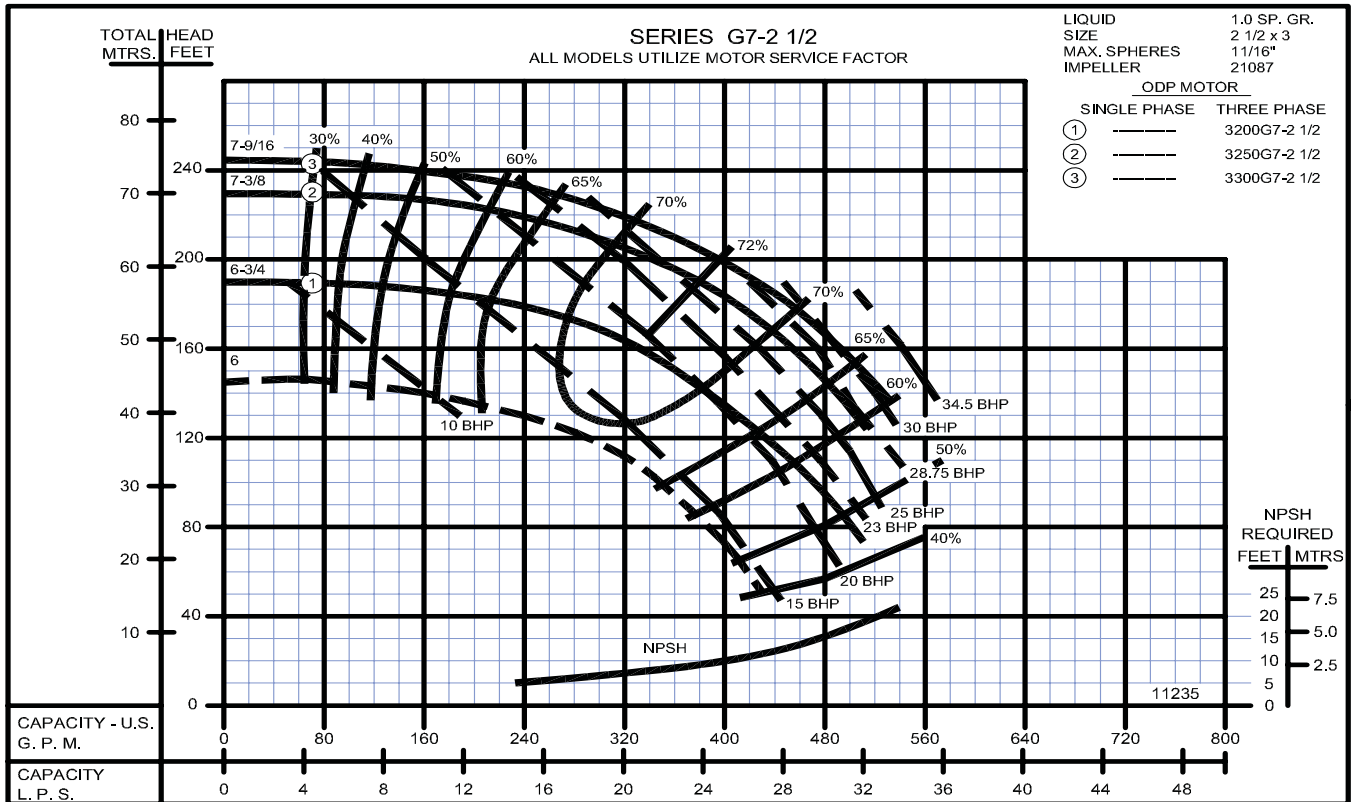

Close Coupled Centrifugal Pumps



Close Coupled Centrifugal Pumps



Close Coupled Centrifugal Pumps



Close Coupled Centrifugal Pumps



Close Coupled Centrifugal Pumps



Close Coupled Centrifugal Pumps



Close Coupled Centrifugal Pumps

1750 RPM



1750 RPM



SECTION 2B
PAGE 40
DATE 1/06

CRANE[®]

PUMPS & SYSTEMS

Close Coupled Centrifugal Pumps



Close Coupled Centrifugal Pumps



Close Coupled Centrifugal Pumps

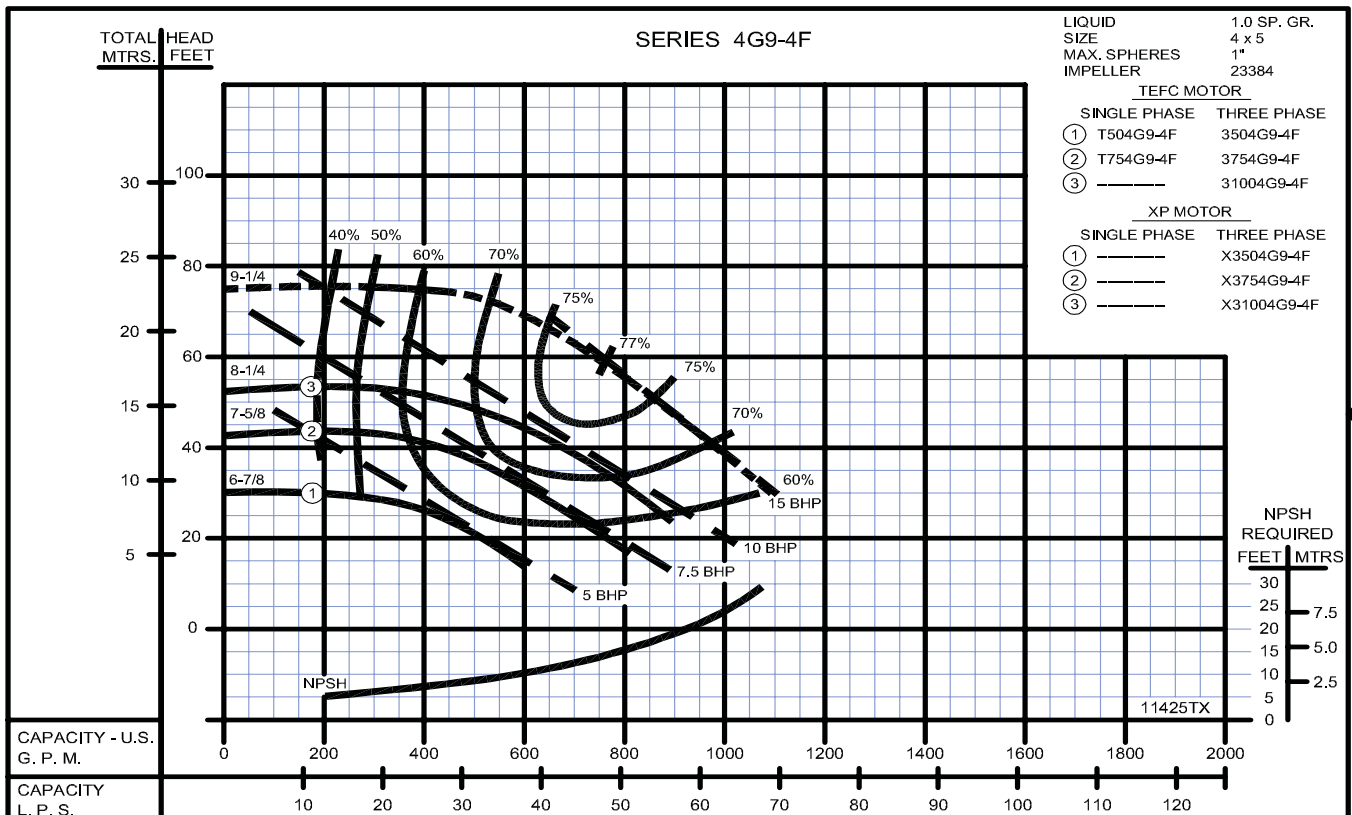
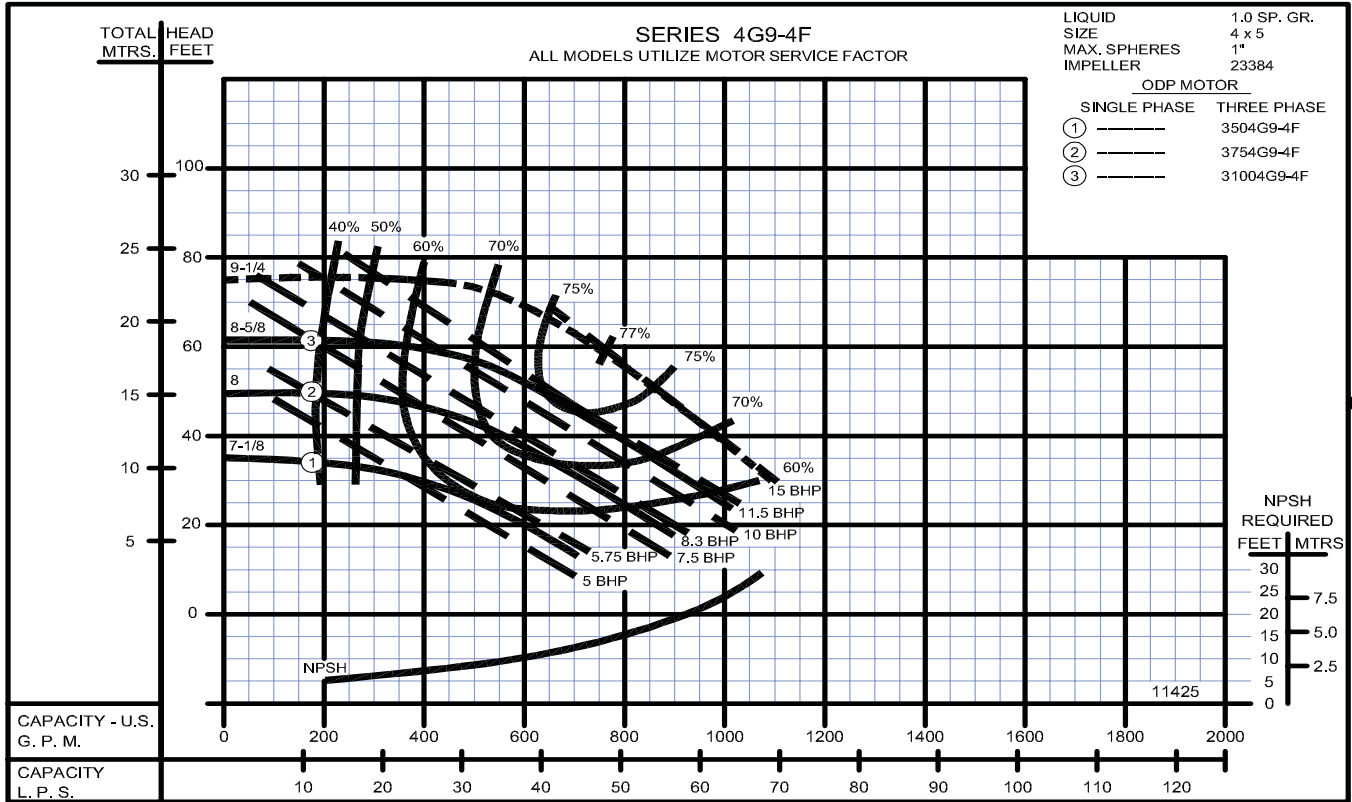

Close Coupled Centrifugal Pumps

1450 RPM



1450 RPM



Close Coupled Centrifugal Pumps



Close Coupled Centrifugal Pumps



Close Coupled Centrifugal Pumps



Close Coupled Centrifugal Pumps



SECTION 2B
PAGE 48
DATE 1/06



PUMPS & SYSTEMS

A Crane Co. Company

USA: (937) 778-8947 • Canada: (905) 457-6223 • International: (937) 615-3598

Close Coupled Centrifugal Pumps

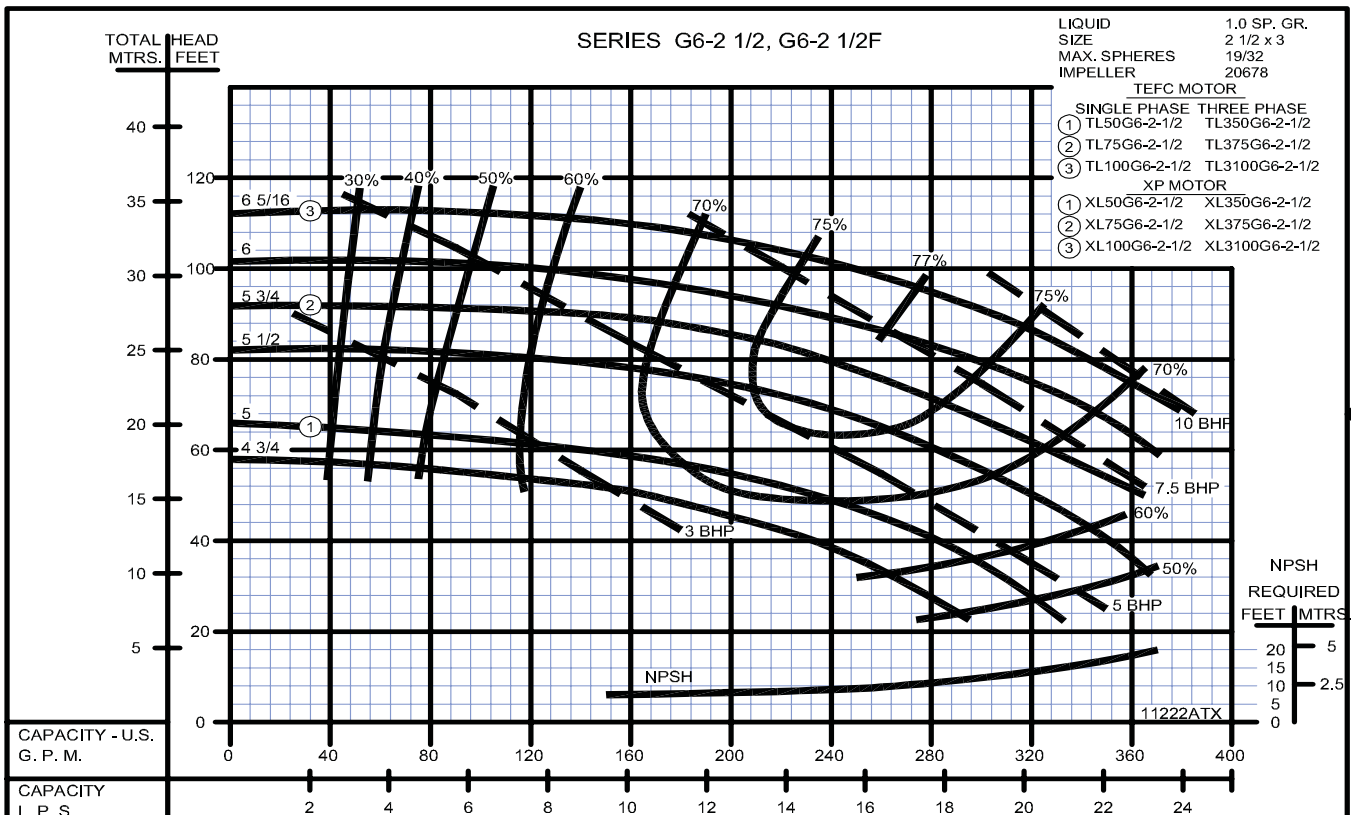
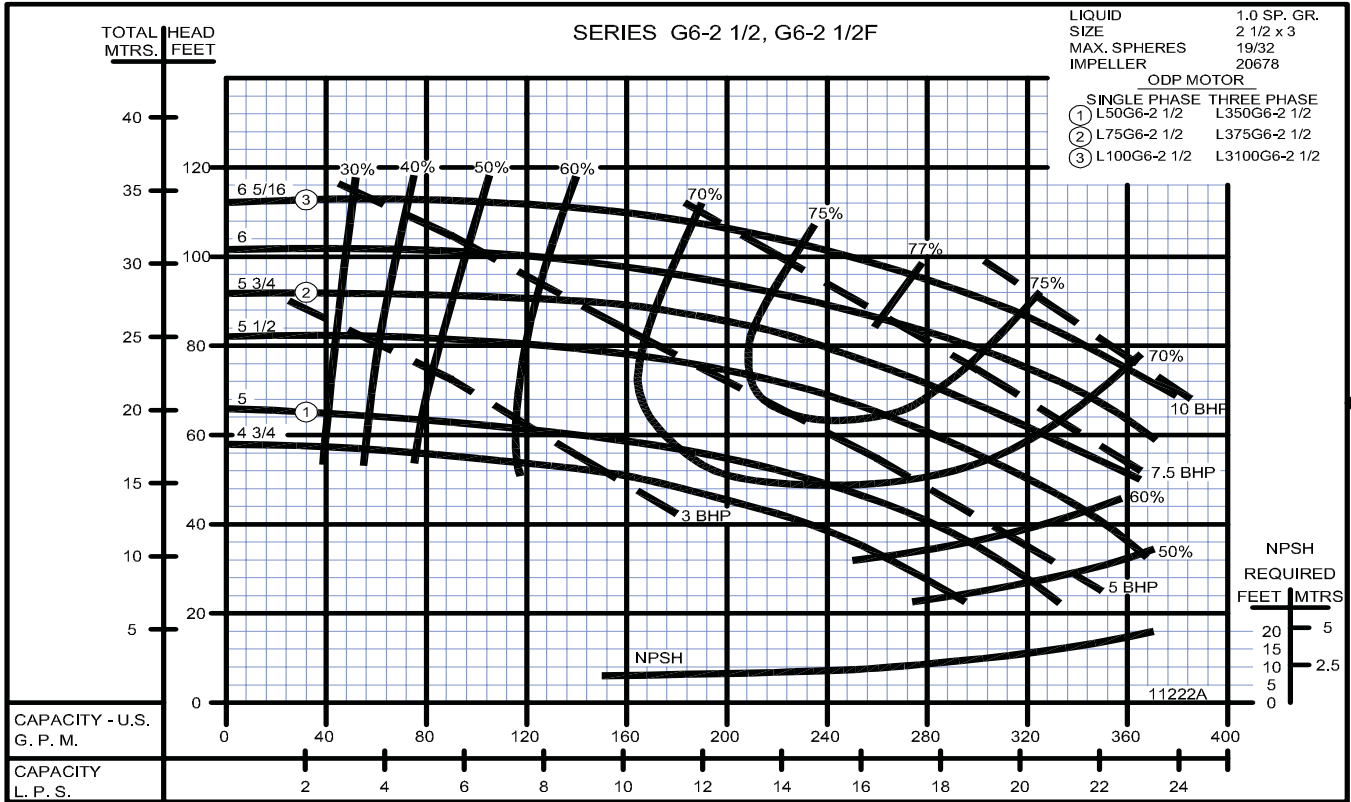

Close Coupled Centrifugal Pumps



Close Coupled Centrifugal Pumps



Close Coupled Centrifugal Pumps

1450 RPM



1450 RPM



SECTION 2B
PAGE 52
DATE 1/06



PUMPS & SYSTEMS

A Crane Co. Company

USA: (937) 778-8947 • Canada: (905) 457-6223 • International: (937) 615-3598

Close Coupled Centrifugal Pumps



Close Coupled Centrifugal Pumps

1450 RPM

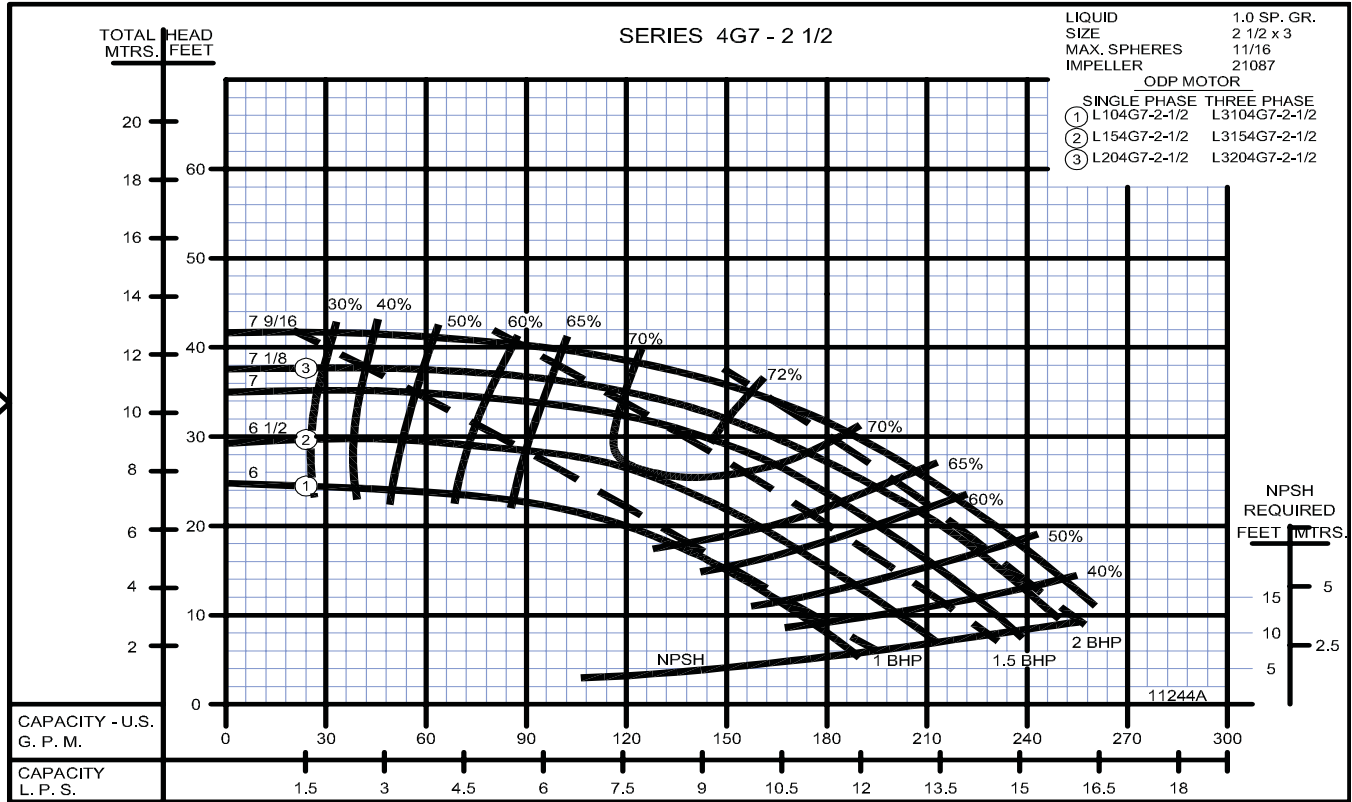

1450 RPM

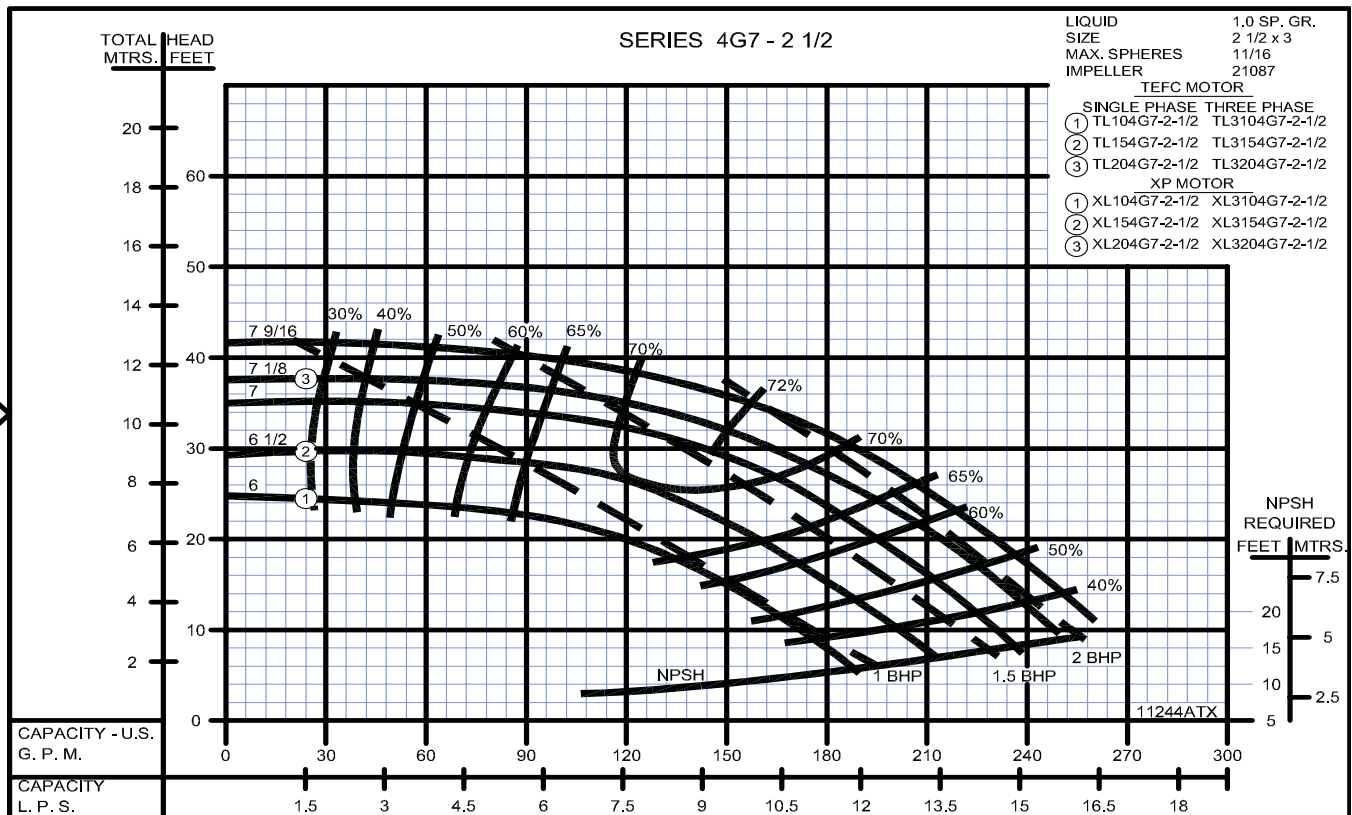

Close Coupled Centrifugal Pumps



Close Coupled Centrifugal Pumps

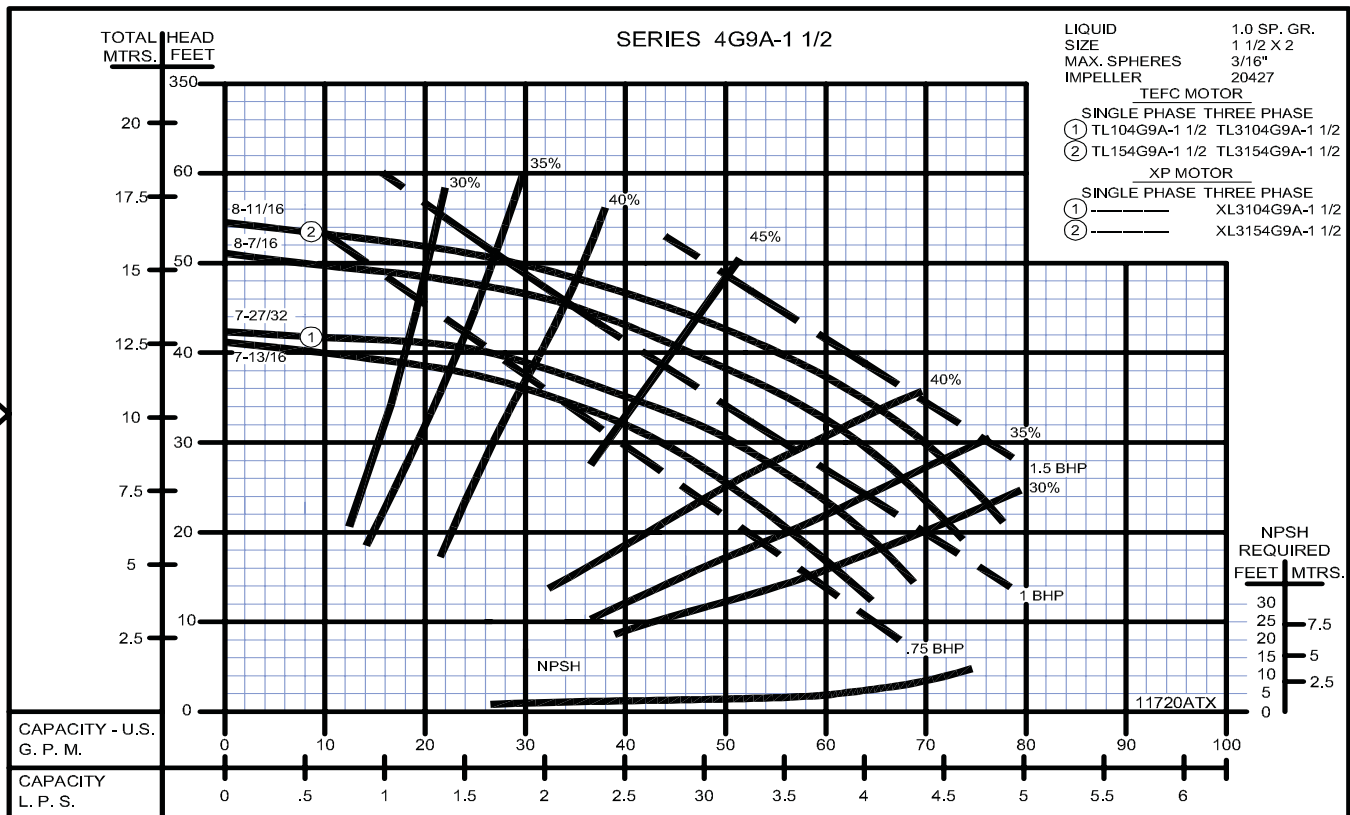

Close Coupled Centrifugal Pumps



Close Coupled Centrifugal Pumps



Close Coupled Centrifugal Pumps



Close Coupled Centrifugal Pumps

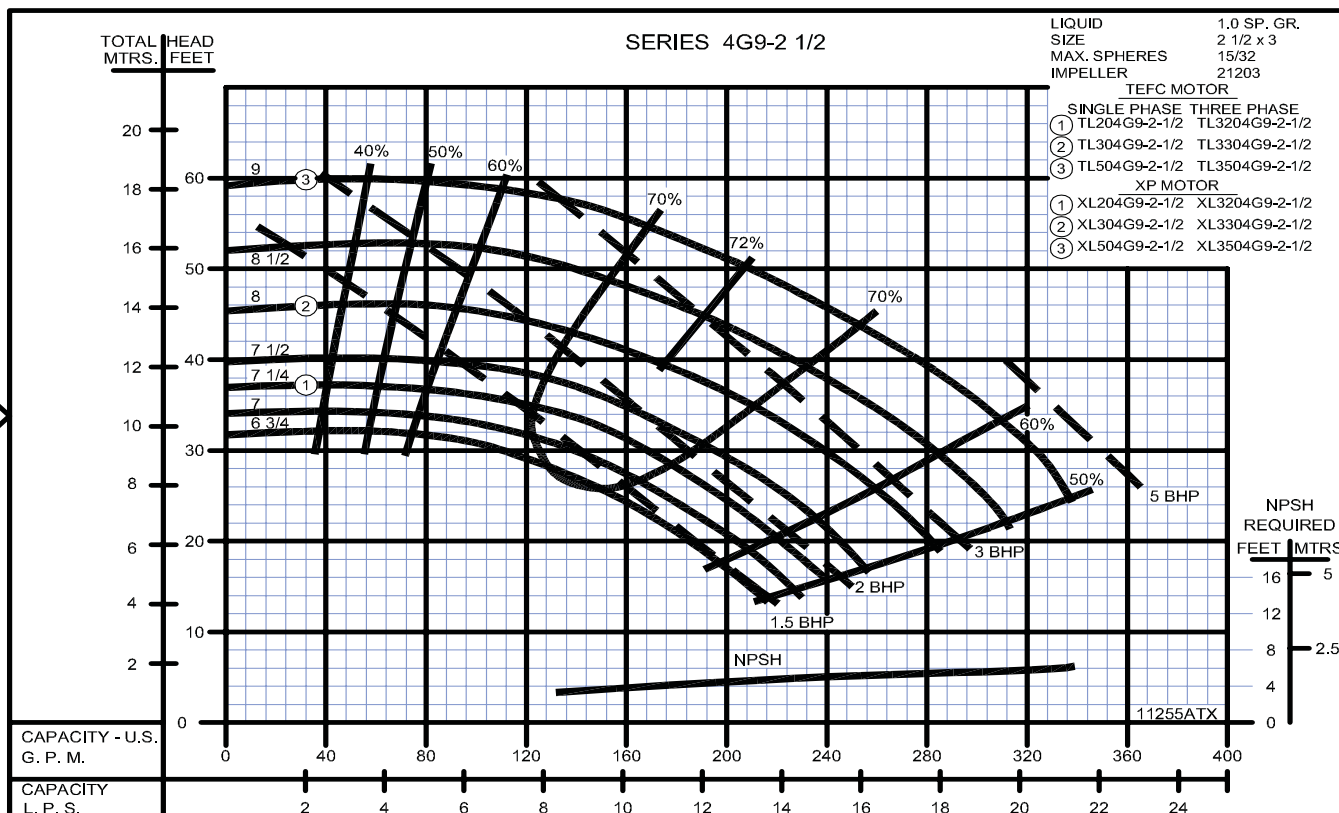
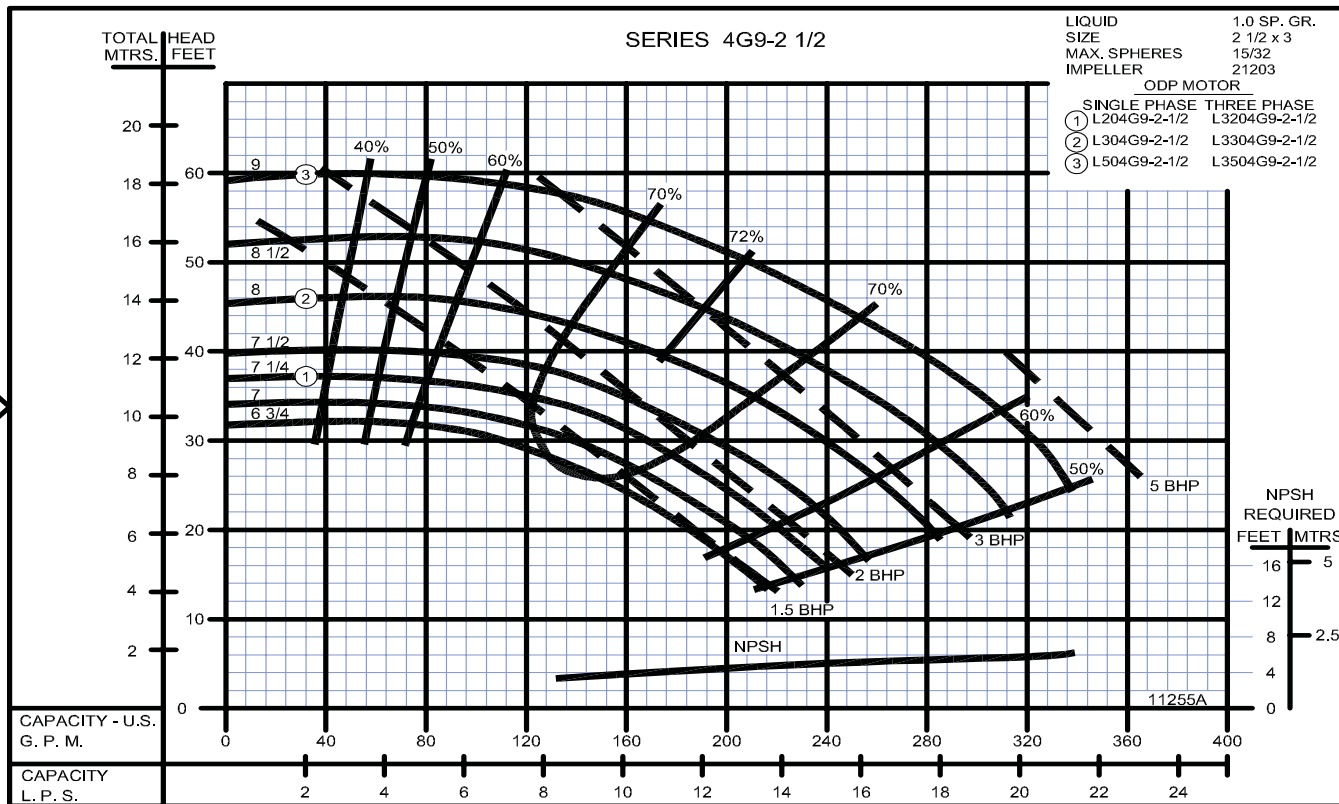

SECTION 2B
PAGE 60
DATE 1/06



PUMPS & SYSTEMS

A Crane Co. Company

USA: (937) 778-8947 • Canada: (905) 457-6223 • International: (937) 615-3598

Close Coupled Centrifugal Pumps

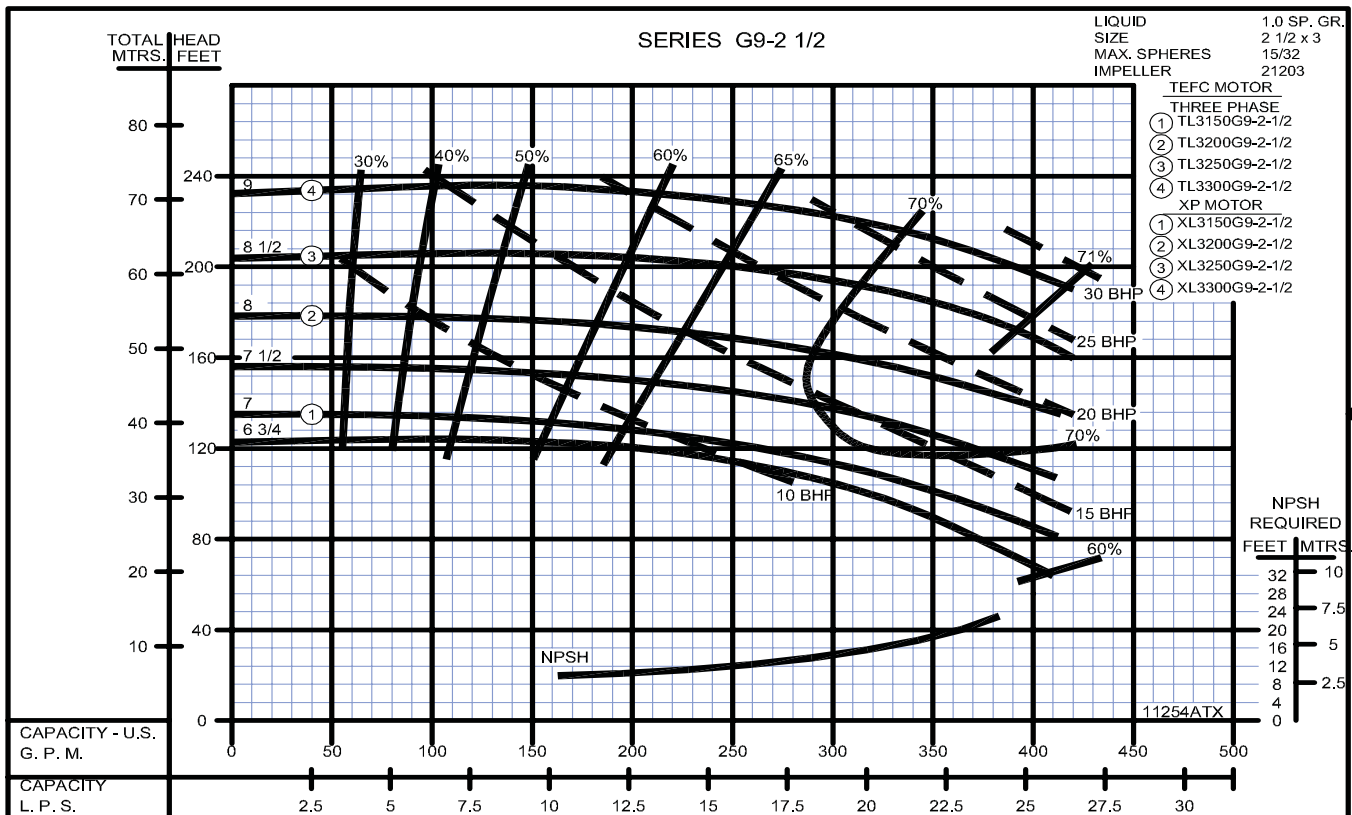
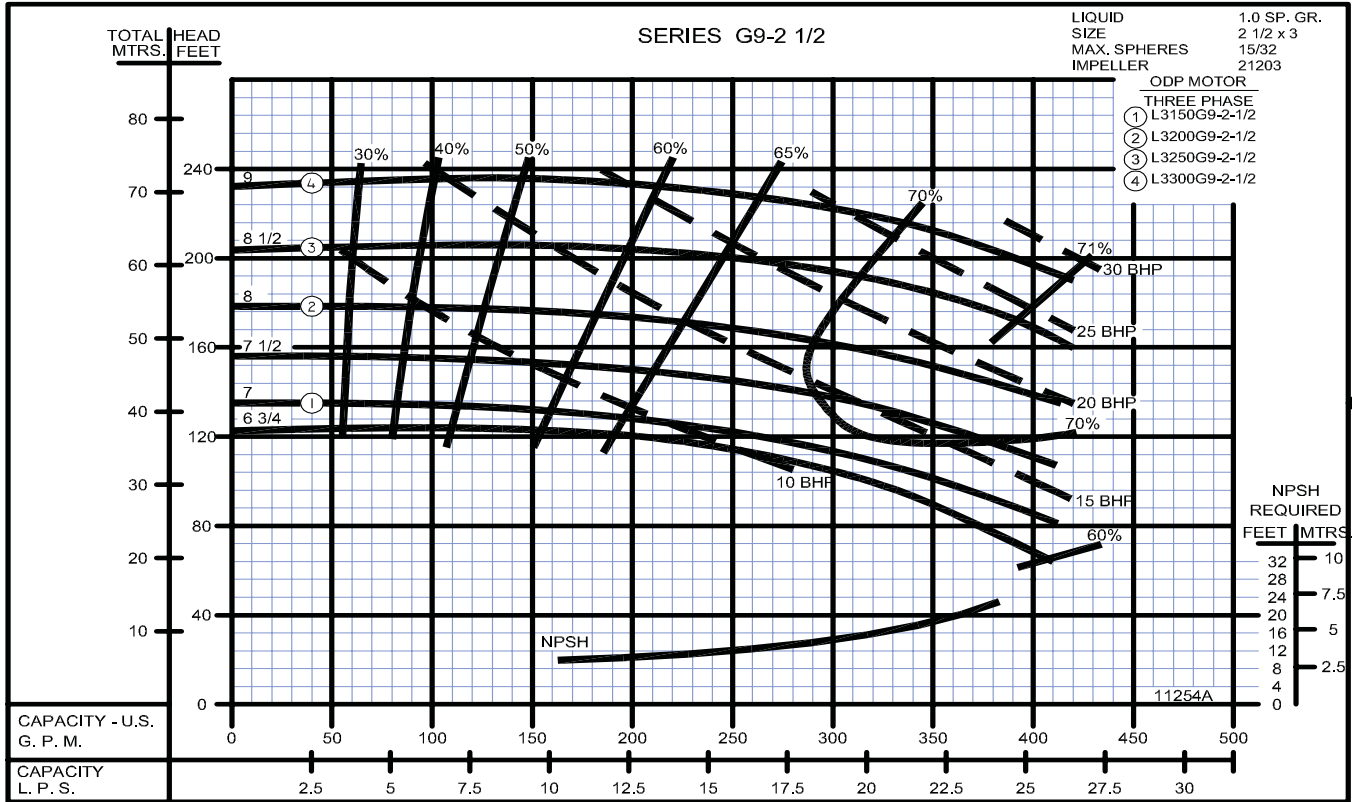

Close Coupled Centrifugal Pumps

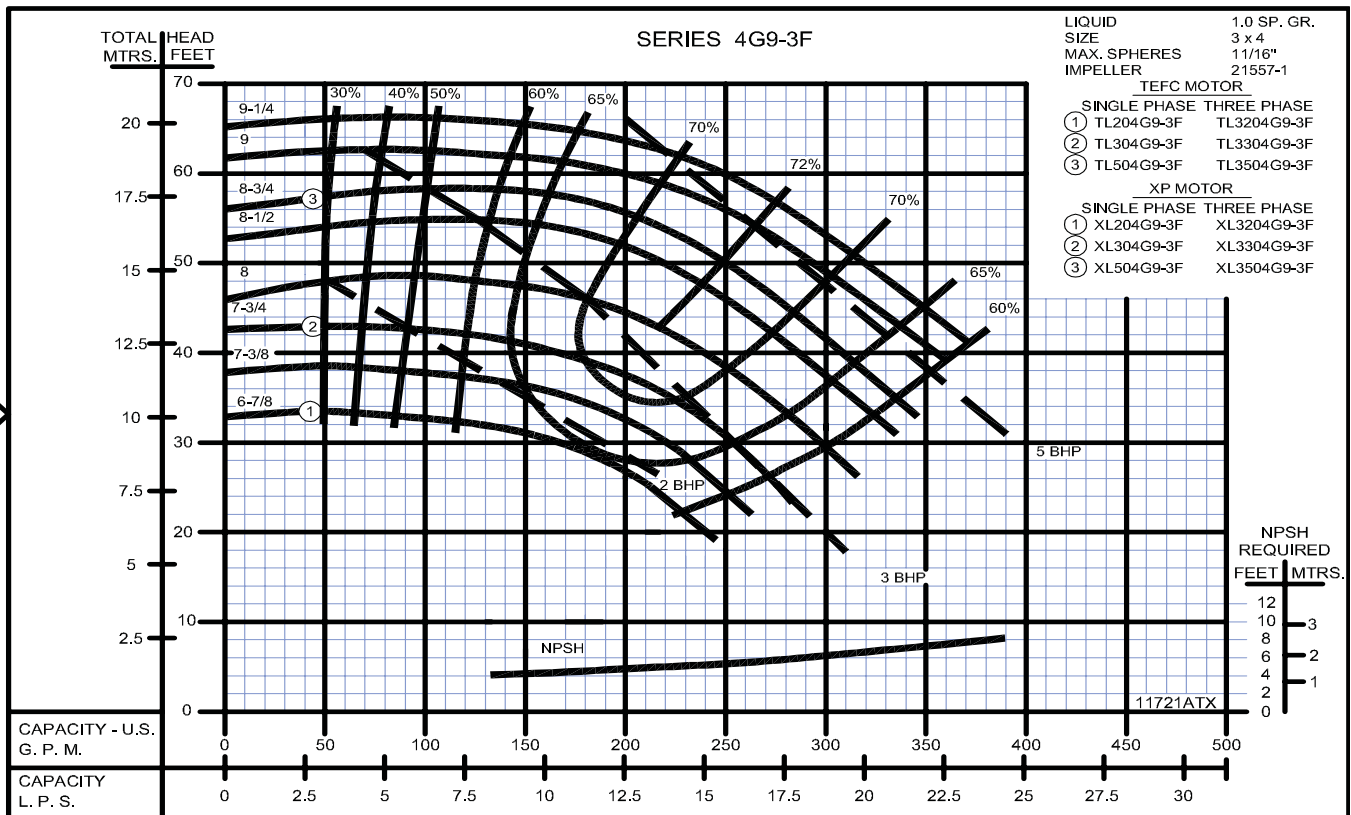

Close Coupled Centrifugal Pumps



Close Coupled Centrifugal Pumps

2900 RPM



2900 RPM



SECTION 2B
PAGE 64
DATE 1/06



PUMPS & SYSTEMS

A Crane Co. Company

USA: (937) 778-8947 • Canada: (905) 457-6223 • International: (937) 615-3598

Close Coupled Centrifugal Pumps

