

Condensate Return Systems

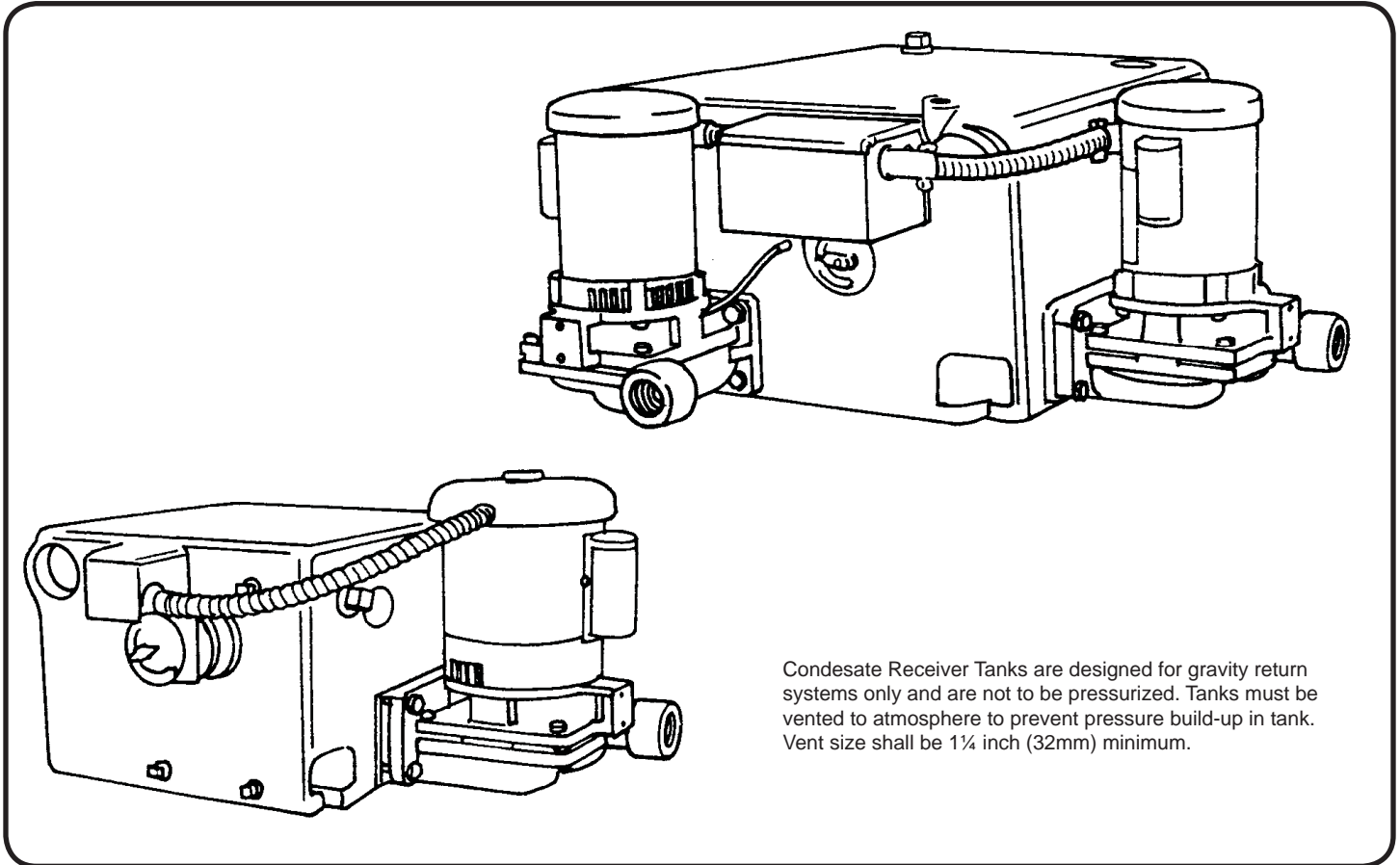

Condensate Receiver Tanks are designed for gravity return systems only and are not to be pressurized. Tanks must be vented to atmosphere to prevent pressure build-up in tank. Vent size shall be 1/4 inch (32mm) minimum.

PUMPS

Vertically flange-mounted centrifugal pumps are of bronze fitted construction with mechanical shaft seal for temperatures to 200°F (93°C).

Seal area is automatically vented and flushed. Back pull-out design allows servicing without disturbing piping.

Bronze impellers are precision balanced for smooth, quiet operation.

Efficient hydraulic design for non-overloading performance at all ratings shown.

RECEIVER TANKS

Rugged cast iron receivers for lifetime service under the most sever conditions. Low return inlet. Available in 9, 14, 20 and 36 gallon (34, 53, 87, and 136 Liters) sizes.

Optional steel receiver available

EVERY pump is factory tested.

MOTORS

Drip-proof NEMA standard motors have dual ball bearings and threaded stainless steel shaft. All single phase motors have built-in overload protection. All three phase motors must be installed with a magnetic starter which provides full overload protection. Failure to use correct starter and overload protectors will void warranty.

Single phase motors thru 2 HP are 115/230 Volt, 60 Hz. 3 HP is 230 Volt only.

Three phase motors are 230/460 Volt, 60 Hz.

CONTROLS

Simplex systems are equipped with a heavy duty adjustable float switch with stainless steel float and rod.

Duplex systems are equipped with a mechanical alternator.

Series: GV

Cast Iron
Performance and Selection



Condensate Return Systems

Max. EDR Sq. Ft.	Equiv. Boiler H.P.	Max. GPM (Liters) Req'd	Discharge Pressure PSIG (kpa)	Simplex Catalog No.	Duplex Catalog No.	Motor H.P.	Pump Discharge Size (NPT)	RECEIVER	
								Size Gals. (Liters)	Inlet Size (NPT)
6,000	40	9 (34)	10 (69)	3GV6-9	3GV6-14D	1/3	1 1/4"	9 (34) Simplex	2"
			20 (138)	5GV6-9	5GV6-14D	1/2			
			30 (207)	10GV6-9	10GV6-14D	1			
			40 (276)	20GV6-9	20GV6-14D	2			
			50 (345)	30GV6-9	30GV6-14D	3			
10,000	70	15 (57)	10 (69)	3GV6-14	3GV6-14D	1/3	1 1/4"	14 (53)	2"
			20 (138)	5GV6-14	5GV6-14D	1/2			
			30 (207)	10GV6-14	10GV6-14D	1			
			40 (276)	20GV6-14	20GV6-14D	2			
			50 (345)	30GV6-14	30GV6-14D	3			
15,000	100	22 1/2 (85.2)	10 (69)	3GV6-20	3GV6-20D	1/3	1 1/4"	20 (76)	2"
			20 (138)	7GV6-20	7GV6-20D	1/2			
			30 (207)	10GV6-20	10GV6-20D	1			
			40 (276)	20GV6-20	20GV6-20D	2			
			50 (345)	30GV6-20	30GV6-20D	3			
20,000	140	30 (114)	10 (69)	3GV6-36	3GV6-36D	1/3	1 1/4"	36 (136)	3"
			20 (138)	5GV6-36	5GV6-36D	3/4			
			30 (207)	10GV6-36	10GV6-36D	1			
			40 (276)	20GV6-36	20GV6-36D	2			
			50 (345)	30GV6-36	30GV6-36D	3			
30,000	215	45 (170)	10 (69)	3GV6-36	3GV6-36D	1/3	1 1/4"	36 (136)	3"
			20 (138)	7GV6-36	7GV6-36D	3/4			
			30 (207)	15GV6-36	15GV6-36D	1 1/2			
			40 (276)	20GV6-36	20GV6-36D	2			
			50 (345)	30GV6-36	30GV6-36D	3			
40,000	285	60 (227)	10 (69)	7GV6-36	7GV6-36D	3/4	1 1/4"	36 (136)	3"
			20 (138)	10GV6-36	10GV6-36D	1			
			30 (207)	20GV6-36	20GV6-36D	2			
			40 (276)	30GV6-36	30GV6-36D	3			
50,000	360	75 (284)	10 (69)	15GV6-36	15GV6-36D	1 1/2	1 1/4"	36 (136)	3"
			20 (138)	20GV6-36	20GV6-36D	2			
			30 (207)	30GV6-36	30GV6-36D	3			
			40 (276)	30GV6-36	30GV6-36D	3			

All selections are based on pump capacities of 1.5 gpm per 1000 sq. ft. of Equivalent Direct Radiation (EDR).

Catalog Numbers shown are for units with single phase motors.

For three phase, add prefix "3" to Catalog No. Example: 35GV6-9

For Steel Receiver, add suffix "-SR" to Catalog No., Example: 10GV6-36-SR

23, 36, 75, 120 gallon (87, 136, 284, 454 Liters) Steel Receivers Available, Consult Factory for Pricing and Dimensions.

SECTION 2F
PAGE 2
DATE 1/06



A Crane Co. Company

PUMPS & SYSTEMS

USA: (937) 778-8947 • Canada: (905) 457-6223 • International: (937) 615-3598

Condensate Return Systems

9 Gallon System

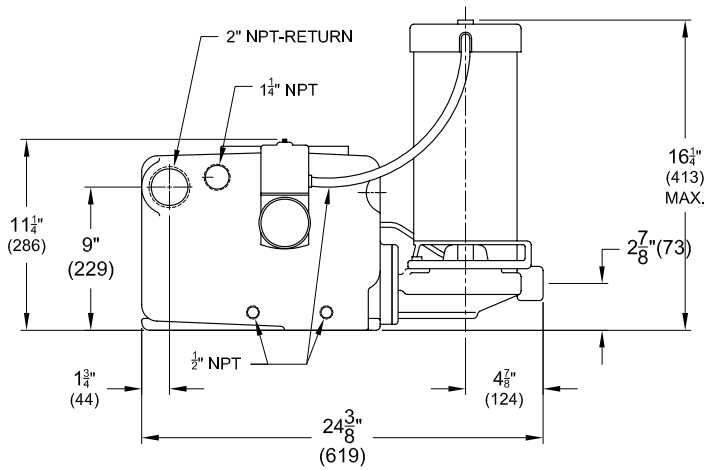
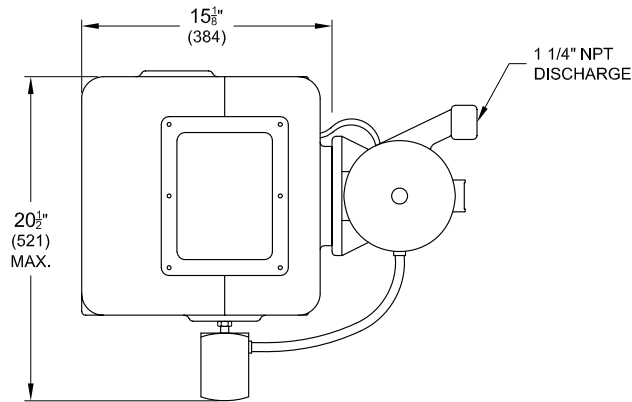

14 Gallon System

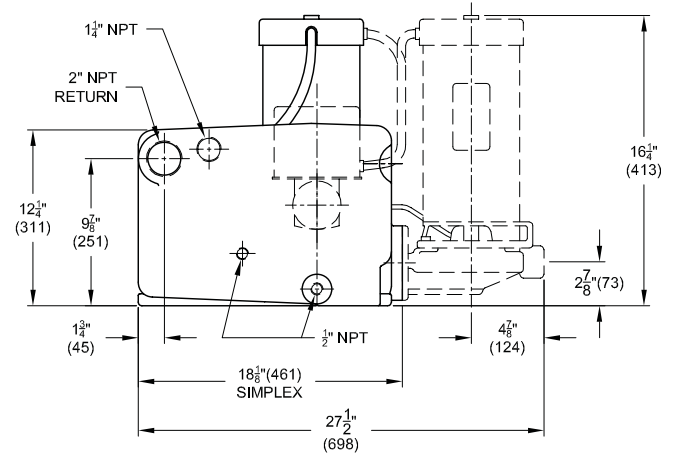
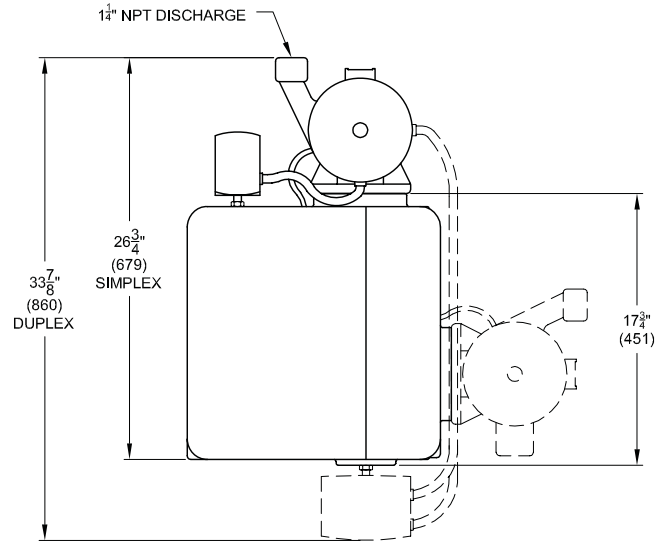

DIMENSIONS FOR STEEL RECEIVERS AVAILABLE ON REQUEST.

Condensate Return Systems

20 Gallon System

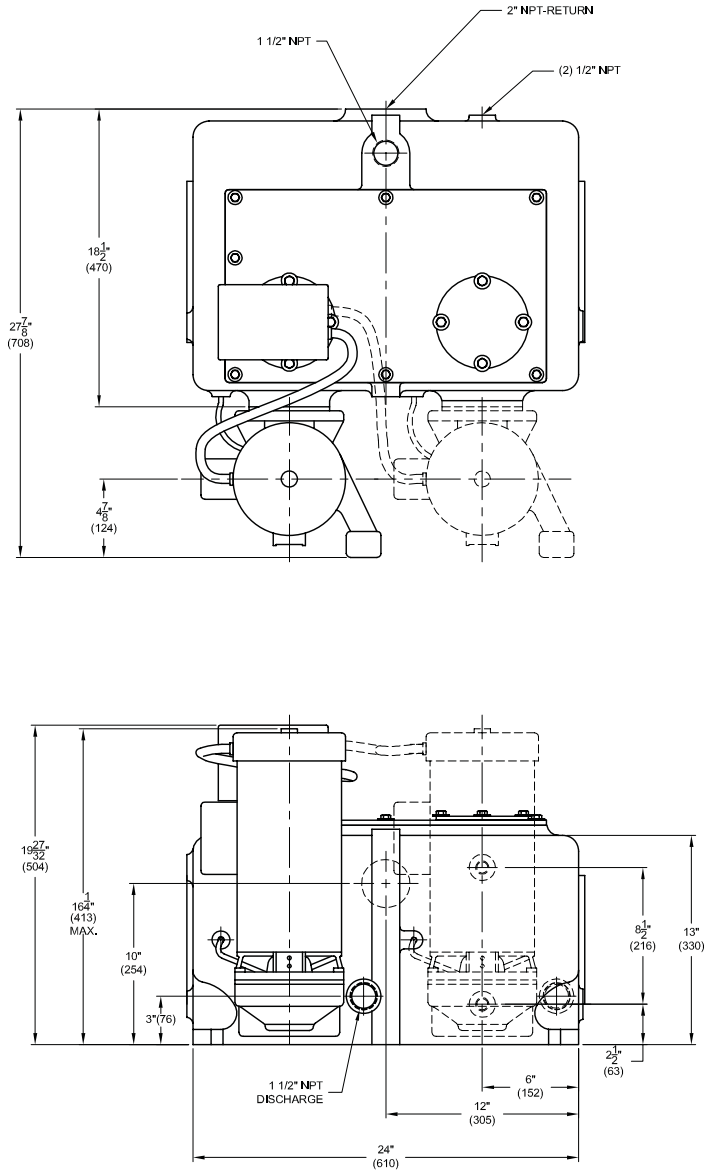

36 Gallon System

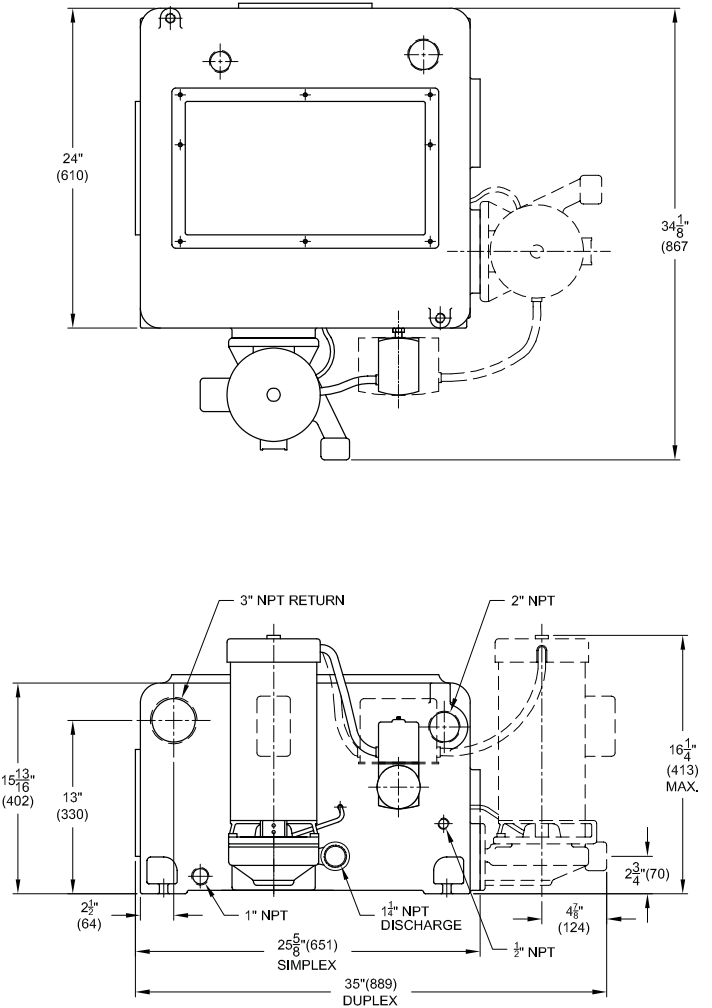

DIMENSIONS FOR STEEL RECEIVERS AVAILABLE ON REQUEST.