

Close Coupled Centrifugal Pumps

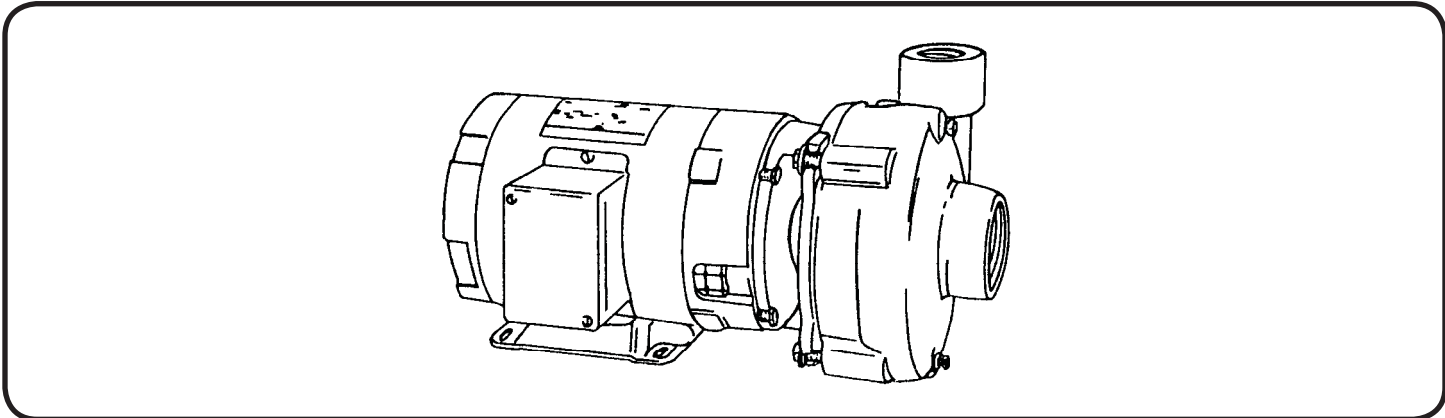

1750 RPM - 60Hz.
CAPACITIES TO 160 GPM (10 LPS)
HEADS TO 57 FEET (17.3 M)

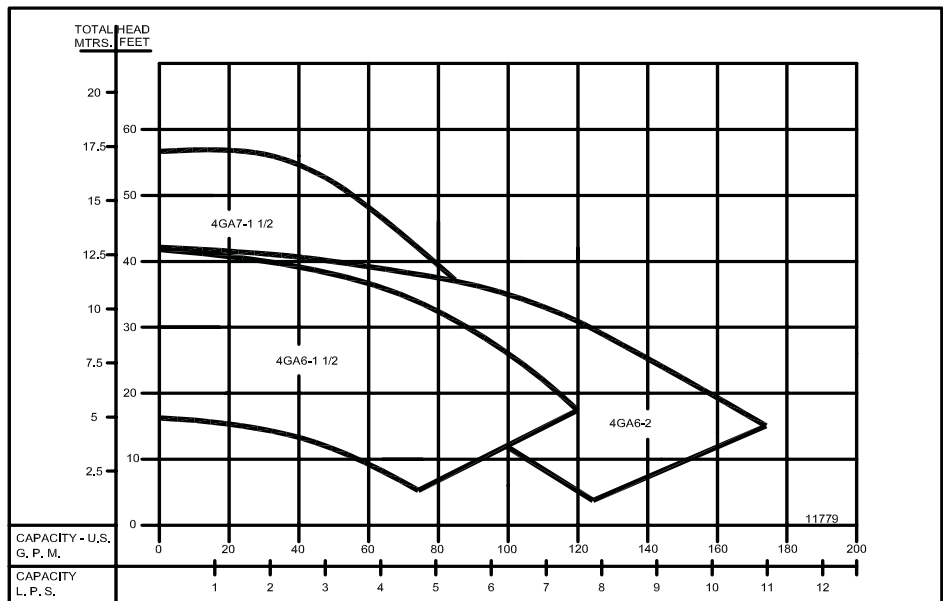

1450 RPM - 50Hz.
CAPACITIES TO 140 GPM (8.8 LPS)
HEADS TO 40 FEET (12 M)

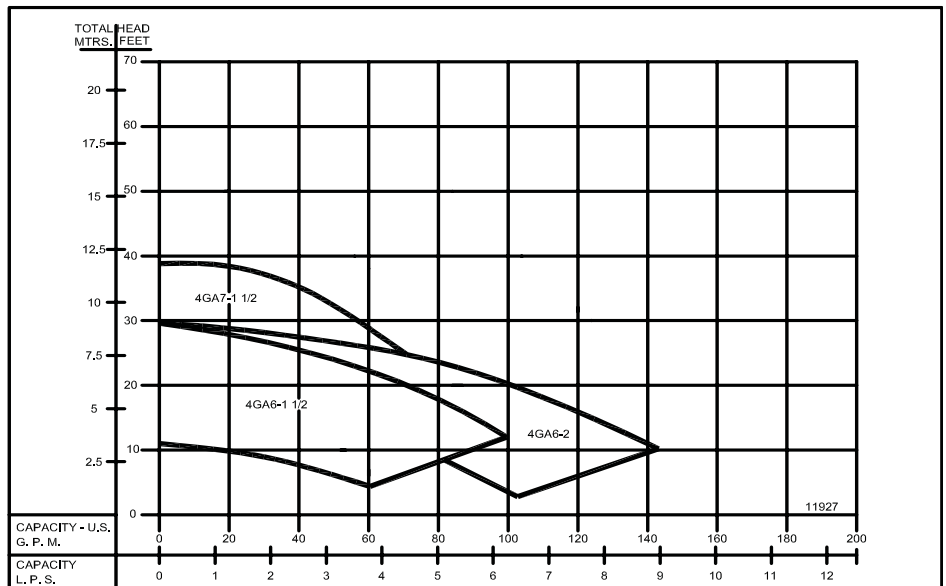

Individual performance curve should be checked for final selection.

Series: GA6-1½, GA6-2,
GA7-1¼, GA7-1½

Close Coupled Centrifugal Pumps

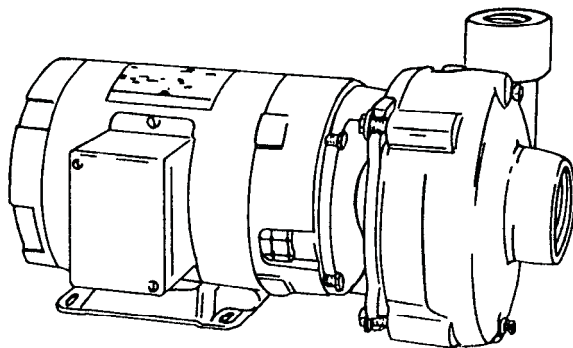

3500 RPM - 60Hz.
CAPACITIES TO 300 GPM (19 LPS)
HEADS TO 230 FEET (70 M)



2900 RPM - 50Hz.
CAPACITIES TO 280 GPM (18 LPS)
HEADS TO 152 FEET (46.3 M)



Individual performance curve should be
checked for final selection.

SECTION 2A
PAGE 28
DATE 1/06

CRANE[®]

A Crane Co. Company

PUMPS & SYSTEMS

USA: (937) 778-8947 • Canada: (905) 457-6223 • International: (937) 615-3598

Close Coupled Centrifugal Pumps

FOUR POSITION CASING

Discharge can be located in any of four positions. Casing is close grain iron of 30,000 psi minimum tensile strength. Back pull-out design eliminates the need to disturb piping should the pump ever require service - the casing stays in the line.

ENCLOSED BRONZE IMPELLER

Of the latest hydraulic design for maximum efficiency, impeller is balanced for vibration-free operation. It is precision fit to shaft with key drive and cap screw lock.

MECHANICAL SHAFT SEAL

Standard self-adjusting shaft seal for temperatures to 225°F (107°C) and pressures to 150 psi (1034kpa). Ceramic seat and carbon seal face for long trouble-free service. Special seals are available for higher temperatures and fluids other than water.

BRONZE SHAFT SLEEVE

Gasketed and keyed hook-type sleeve protects shaft from wear and corrosion in seal area.

MOTORS

JM Type motors have NEMA standard mounting flange, extended steel shaft and dual bearings. These motors offer the advantages of quiet operation, controlled shaft deflection for longer seal life, and bearings sized to provide good service life. All motors are supplied by manufacturers with national field service facilities.

FACTORY TESTED

After careful assembly and inspection, EVERY pump is factory tested and will meet Hydraulic Institute standards.

MAXIMUM OPERATING CONDITIONS

| | |
|---|-------------------|
| TEMPERATURE (For Standard Buna-N Seal) | 225°F (107°C) |
| INLET PRESSURE | 100 PSI (690kPa) |
| CASING WORKING PRESSURE | 200 PSI (1379kPa) |

MOTOR INFORMATION

60 Hz - 1750 RPM - ODP

60 Hz - 3500 RPM - ODP

Single Phase: 1 thru 2 Hp. - 115/230 V

3 & 7 1/2 Hp. - 230 V.

Three Phase: 1 thru 10 Hp. - 230/460 V

50 Hz - 2900 RPM - ODP

50 Hz - 1450 RPM - ODP

Single Phase: 110/220 Volt

Three Phase: 380 Volt

Voltages may differ from some suppliers. Consult factory.
Overload Protection: All motors must be installed with magnetic starter which provides full overload protection on all legs. Failure to use correct starter and overloads will void motor warranty.

GA6 Series pumps are not available with 7-1/2 HP Totally Enclosed or Explosion Proof motors.

MATERIALS OF CONSTRUCTION

| PART | ◆ ALL IRON | BRONZE FITTED | ALL BRONZE |
|--------------|-------------------------------|-------------------------------|-------------------------------|
| Adapter | Cast Iron | Cast Iron | Bronze |
| Casing | Cast Iron | Cast Iron | Bronze |
| Impeller | Bronze | Bronze | Bronze |
| Shaft | Steel | Steel | Steel |
| Shaft Sleeve | #316 Stainless | Bronze | Bronze |
| Shaft Seal | Carbon-Ceramic SS - Buna-N | Carbon-Ceramic SS - Buna-N | Carbon-Ceramic SS - Buna-N |

(◆) Does **NOT** include GA7-1½.

Series: GA6-1½, GA6-2,
GA7-1¼, GA7-1½

Dimensions



Close Coupled Centrifugal Pumps



| MODEL | | HP | MOTOR FRAME SIZE | DISC NPT (in) | SUCT NPT (in) | DIMENSIONS IN INCHES | | | | | | | | | | | | | | | |
|-----------|------------|----|------------------|---------------|---------------------------------|----------------------|---------------------------------|----|----------------------------------|--------------------------------|---------------------------------|----|--------------------------------|----------------------------------|--------------------------------|----------------------------------|--------------------------------|---------------------------------|---------------------------------|--------------------------------|--------------------------------|
| 1 Phase | 3 Phase | | | | | A | AB | B | CP | D | DD | E | F | G | H | L | X | Y | Z | | |
| 104GA6-1½ | 3104GA6-1½ | 1 | 143JM | 1½ | 2 | 7 | 8 ¹⁵ / ₁₆ | 5 | 15 ¹³ / ₁₆ | 4 ⁵ / ₁₆ | 3½ | 2¼ | 2 | ¾ | 1 ¹ / ₃₂ | 9 ⁵ / ₈ | 4¾ | 2 ⁹ / ₁₆ | 3 ¹³ / ₁₆ | | |
| 15GA6-1½ | 315GA6-1½ | 1½ | 143JM | | | 7 | 8 ¹⁵ / ₁₆ | 5 | 15 ¹³ / ₁₆ | 4 ⁵ / ₁₆ | 3½ | 2¼ | 2 | ¾ | 1 ¹ / ₃₂ | 9 ⁵ / ₈ | 4¾ | 2 ⁹ / ₁₆ | 3 ¹³ / ₁₆ | | |
| 20GA6-1½ | 320GA6-1½ | 2 | 145JM | | | 7 | 8 ¹⁵ / ₁₆ | 6 | 16 ¹ / ₁₆ | 4 ⁵ / ₁₆ | 3½ | 2¼ | 2½ | ¾ | 1 ¹ / ₃₂ | 9 ⁵ / ₈ | 4¾ | 2 ⁹ / ₁₆ | 3 ¹³ / ₁₆ | | |
| 30GA6-1½ | 330GA6-1½ | 3 | 145JM | | | 7 | 8 ¹⁵ / ₁₆ | 6 | 16 ¹³ / ₁₆ | 4 ⁵ / ₁₆ | 3½ | 2¼ | 2½ | ¾ | 1 ¹ / ₃₂ | 9 ⁵ / ₈ | 4¾ | 2 ⁹ / ₁₆ | 3 ¹³ / ₁₆ | | |
| 50GA6-1½ | 350GA6-1½ | 5 | 182JM | | | 8¾ | 9 ⁷ / ₈ | 5¾ | 17 ⁹ / ₁₆ | 4 ⁵ / ₁₆ | 4½ | 3¾ | 2¼ | ½ | 1 ³ / ₃₂ | 10 ³ / ₈ | 4¾ | 2 ⁹ / ₁₆ | 3 ¹³ / ₁₆ | | |
| ----- | 375GA6-1½ | 7½ | 184JM | | | 8¾ | 9 ⁷ / ₈ | 6¾ | 18 ⁹ / ₁₆ | 4 ⁵ / ₁₆ | 4½ | 3¾ | 2¼ | ½ | 1 ³ / ₃₂ | 10 ³ / ₈ | 4¾ | 2 ⁹ / ₁₆ | 3 ¹³ / ₁₆ | | |
| 104GA6-2 | 3104GA6-2 | 1 | 143JM | 2 | 2½ | 7 | 8 ¹⁵ / ₁₆ | 5 | 16 ¹ / ₁₆ | 4 ⁵ / ₈ | 3½ | 2¼ | 2 | ¾ | 1 ¹ / ₃₂ | 9 ⁷ / ₈ | 5 ⁷ / ₁₆ | 2¾ | 4 | | |
| 154GA6-2 | 3154GA6-2 | 1½ | 145JM | | | 7 | 8 ¹⁵ / ₁₆ | 6 | 17 ¹ / ₁₆ | 4 ⁵ / ₈ | 3½ | 2¼ | 2½ | ¾ | 1 ¹ / ₃₂ | 9 ⁷ / ₈ | 5 ⁷ / ₁₆ | 2¾ | 4 | | |
| 30GA6-2 | 330GA6-2 | 3 | 145JM | | | 7 | 8 ¹⁵ / ₁₆ | 6 | 17 ¹ / ₁₆ | 4 ⁵ / ₈ | 3½ | 2¼ | 2½ | ¾ | 1 ¹ / ₃₂ | 9 ⁷ / ₈ | 5 ⁷ / ₁₆ | 2¾ | 4 | | |
| 50GA6-2 | 350GA6-2 | 5 | 182JM | | | 8¾ | 9 ⁷ / ₈ | 5¾ | 17 ¹³ / ₁₆ | 4 ⁵ / ₈ | 4½ | 3¾ | 2¼ | ½ | 1 ³ / ₃₂ | 10 ³ / ₈ | 5 ⁷ / ₁₆ | 2¾ | 4 | | |
| ----- | 375GA6-2 | 7½ | 184JM | | | 8¾ | 9 ⁷ / ₈ | 6¾ | 18 ¹ / ₁₆ | 4 ⁵ / ₈ | 4½ | 3¾ | 2¼ | ½ | 1 ³ / ₃₂ | 10 ³ / ₈ | 5 ⁷ / ₁₆ | 2¾ | 4 | | |
| 30GA7-1¼ | 330GA7-1¼ | 3 | 145JM | | | 1¼ | 1½ | 7 | 8 ¹⁵ / ₁₆ | 6 | 17 ⁷ / ₁₆ | 3½ | 4½ | 2¼ | 2½ | ¾ | 1 ¹ / ₃₂ | 10 ⁷ / ₁₆ | 5 ⁵ / ₈ | 3 ⁵ / ₁₆ | 4 ¹ / ₁₆ |
| 50GA7-1¼ | 350GA7-1¼ | 5 | 182JM | 8¾ | 9 ⁷ / ₈ | | | 5¾ | 18 ³ / ₁₆ | 4½ | 4½ | 3¾ | 2¼ | ½ | 1 ³ / ₃₂ | 11 | 5 ⁵ / ₈ | 3 ⁵ / ₁₆ | 4 ¹ / ₁₆ | | |
| ----- | 375GA7-1¼ | 7½ | 184JM | 8¾ | 9 ⁷ / ₈ | | | 6¾ | 19 ³ / ₁₆ | 4½ | 4½ | 3¾ | 2¼ | ½ | 1 ³ / ₃₂ | 11 | 5 ⁵ / ₈ | 3 ⁵ / ₁₆ | 4 ¹ / ₁₆ | | |
| 104GA7-1½ | 3104GA7-1½ | 1 | 143JM | 1½ | 2 | | | 7 | 8 ¹⁵ / ₁₆ | 5 | 16½ | 3½ | 4 ⁹ / ₁₆ | 2¼ | 2 | ¾ | 1 ¹ / ₃₂ | 10 ⁵ / ₁₆ | 6 | 3 ⁵ / ₁₆ | 4¼ |
| 154GA7-1½ | 3154GA7-1½ | 1½ | 145JM | | | | | 7 | 8 ¹⁵ / ₁₆ | 6 | 17½ | 3½ | 4 ⁹ / ₁₆ | 2¼ | 2½ | ¾ | 1 ¹ / ₃₂ | 10 ⁵ / ₁₆ | 6 | 3 ⁵ / ₁₆ | 4¼ |
| 50GA7-1½ | ----- | 5 | 184JM | | | | | 9 | 9 ⁷ / ₈ | 6¾ | 19¼ | 4½ | 4 ⁹ / ₁₆ | 3¾ | 2¼ | ½ | 1 ³ / ₃₂ | 11 ¹ / ₁₆ | 6 | 3 ⁵ / ₁₆ | 4¼ |
| ----- | 350GA7-1½ | 5 | 182JM | | | 9 | 9 ⁷ / ₈ | 5¾ | 18¼ | 4½ | 4 ⁹ / ₁₆ | 3¾ | 2¼ | ½ | 1 ³ / ₃₂ | 11 ¹ / ₁₆ | 6 | 3 ⁵ / ₁₆ | 4¼ | | |
| 75GA7-1½ | ----- | 7½ | 213JM | | | 10½ | 11 ¹ / ₁₆ | 7¼ | 20¾ | 5¼ | 4 ⁹ / ₁₆ | 4¼ | 2¼ | ¾ | 1 ³ / ₃₂ | 11 ¹⁵ / ₁₆ | 6 | 3 ⁵ / ₁₆ | 4¼ | | |
| ----- | 375GA7-1½ | 7½ | 184JM | | | 9 | 9 ⁷ / ₈ | 6¾ | 19¼ | 4½ | 4 ⁹ / ₁₆ | 3¾ | 2¼ | ½ | 1 ³ / ₃₂ | 11 ¹ / ₁₆ | 6 | 3 ⁵ / ₁₆ | 4¼ | | |
| ----- | 3100GA7-1½ | 10 | 213JM | 10½ | 11 ¹ / ₁₆ | 7¼ | 20¾ | 5¼ | 4 ⁹ / ₁₆ | 4¼ | 2¼ | ¾ | 1 ³ / ₃₂ | 11 ¹⁵ / ₁₆ | 6 | 3 ⁵ / ₁₆ | 4¼ | | | | |

DIMENSIONS SHOWN ABOVE ARE APPROXIMATE MAXIMUM DIMENSIONS FOR STANDARD PUMPS EQUIPPED WITH ODP MOTORS.

SECTION 2A
PAGE 30
DATE 1/06



A Crane Co. Company

PUMPS & SYSTEMS

USA: (937) 778-8947 • Canada: (905) 457-6223 • International: (937) 615-3598

Close Coupled Centrifugal Pumps

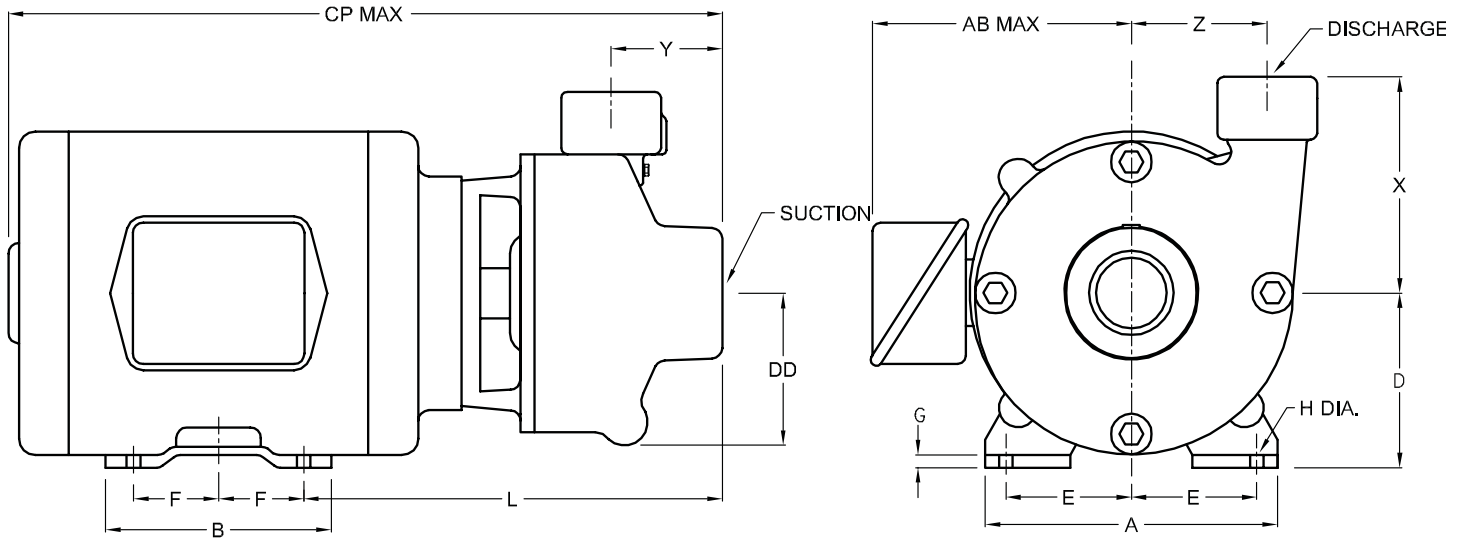

| DIMENSIONS IN MILLIMETERS | | | | | | | | | | | | | | | | | | | |
|---------------------------|------------|----|------------------|---------------|---------------|-----|-----|-----|-----|-----|-----|-----|----|------|------|-----|-----|----|-----|
| MODEL | | HP | MOTOR FRAME SIZE | DISC NPT (in) | SUCT NPT (in) | A | AB | B | CP | D | DD | E | F | G | H | L | X | Y | Z |
| 1 Phase | 3 Phase | | | | | | | | | | | | | | | | | | |
| 104GA6-1½ | 3104GA6-1½ | 1 | 143JM | 1½ | 2 | 178 | 227 | 127 | 402 | 109 | 89 | 70 | 51 | 9.5 | 9 | 244 | 121 | 65 | 97 |
| 15GA6-1½ | 315GA6-1½ | 1½ | 143JM | | | 178 | 227 | 127 | 402 | 109 | 89 | 70 | 51 | 9.5 | 9 | 244 | 121 | 65 | 97 |
| 20GA6-1½ | 320GA6-1½ | 2 | 145JM | | | 178 | 227 | 152 | 427 | 109 | 89 | 70 | 64 | 9.5 | 9 | 244 | 121 | 65 | 97 |
| 30GA6-1½ | 330GA6-1½ | 3 | 145JM | | | 178 | 227 | 152 | 427 | 109 | 89 | 70 | 64 | 9.5 | 9 | 244 | 121 | 65 | 97 |
| 50GA6-1½ | 350GA6-1½ | 5 | 182JM | | | 222 | 251 | 146 | 446 | 109 | 114 | 95 | 57 | 13 | 10 | 263 | 121 | 65 | 97 |
| ----- | 375GA6-1½ | 7½ | 184JM | | | 222 | 251 | 171 | 471 | 109 | 114 | 95 | 70 | 13 | 10 | 263 | 121 | 65 | 97 |
| 104GA6-2 | 3104GA6-2 | 1 | 143JM | 2 | 2½ | 178 | 227 | 127 | 408 | 117 | 89 | 70 | 51 | 9.5 | 9 | 251 | 138 | 70 | 102 |
| 154GA6-2 | 3154GA6-2 | 1½ | 145JM | | | 178 | 227 | 152 | 433 | 117 | 89 | 70 | 64 | 9.5 | 9 | 251 | 138 | 70 | 102 |
| 30GA6-2 | 330GA6-2 | 3 | 145JM | 2 | 2½ | 178 | 227 | 152 | 433 | 117 | 89 | 70 | 64 | 9.5 | 9 | 251 | 138 | 70 | 102 |
| 50GA6-2 | 350GA6-2 | 5 | 182JM | | | 222 | 251 | 146 | 452 | 117 | 114 | 95 | 57 | 13 | 10 | 270 | 138 | 70 | 102 |
| ----- | 375GA6-2 | 7½ | 184JM | 222 | 251 | 171 | 478 | 117 | 114 | 95 | 70 | 13 | 10 | 270 | 138 | 70 | 102 | | |
| 30GA7-1¼ | 330GA7-1¼ | 3 | 145JM | 1¼ | 1½ | 178 | 227 | 152 | 443 | 89 | 114 | 70 | 64 | 9.5 | 8.7 | 260 | 143 | 84 | 103 |
| 50GA7-1¼ | 350GA7-1¼ | 5 | 182JM | | | 222 | 251 | 146 | 462 | 114 | 114 | 95 | 57 | 12.7 | 10.3 | 279 | 143 | 84 | 103 |
| ----- | 375GA7-1¼ | 7½ | 184JM | | | 222 | 251 | 172 | 487 | 114 | 114 | 95 | 70 | 12.7 | 10.3 | 279 | 143 | 84 | 103 |
| 104GA7-1½ | 3104GA7-1½ | 1 | 143JM | 1½ | 2 | 178 | 227 | 127 | 419 | 89 | 116 | 70 | 51 | 9.5 | 8.7 | 262 | 152 | 84 | 108 |
| 154GA7-1½ | 3154GA7-1½ | 1½ | 145JM | | | 178 | 227 | 152 | 445 | 89 | 116 | 70 | 64 | 9.5 | 8.7 | 262 | 152 | 84 | 108 |
| 50GA7-1½ | ----- | 5 | 184JM | 1½ | 2 | 229 | 251 | 171 | 489 | 114 | 116 | 95 | 70 | 13 | 10 | 281 | 152 | 84 | 108 |
| ----- | 350GA7-1½ | 5 | 182JM | | | 229 | 251 | 146 | 463 | 114 | 116 | 95 | 57 | 13 | 10 | 281 | 152 | 84 | 108 |
| 75GA7-1½ | ----- | 7½ | 213JM | | | 267 | 281 | 184 | 527 | 133 | 116 | 108 | 70 | 16 | 10 | 303 | 152 | 84 | 108 |
| ----- | 375GA7-1½ | 7½ | 184JM | | | 229 | 251 | 171 | 489 | 114 | 116 | 95 | 70 | 13 | 10 | 281 | 152 | 84 | 108 |
| ----- | 3100GA7-1½ | 10 | 213JM | | | 267 | 281 | 184 | 527 | 133 | 116 | 108 | 70 | 16 | 10 | 303 | 152 | 84 | 108 |

DIMENSIONS SHOWN ABOVE ARE APPROXIMATE MAXIMUM DIMENSIONS FOR STANDARD PUMPS EQUIPPED WITH ODP MOTORS.

Close Coupled Centrifugal Pumps

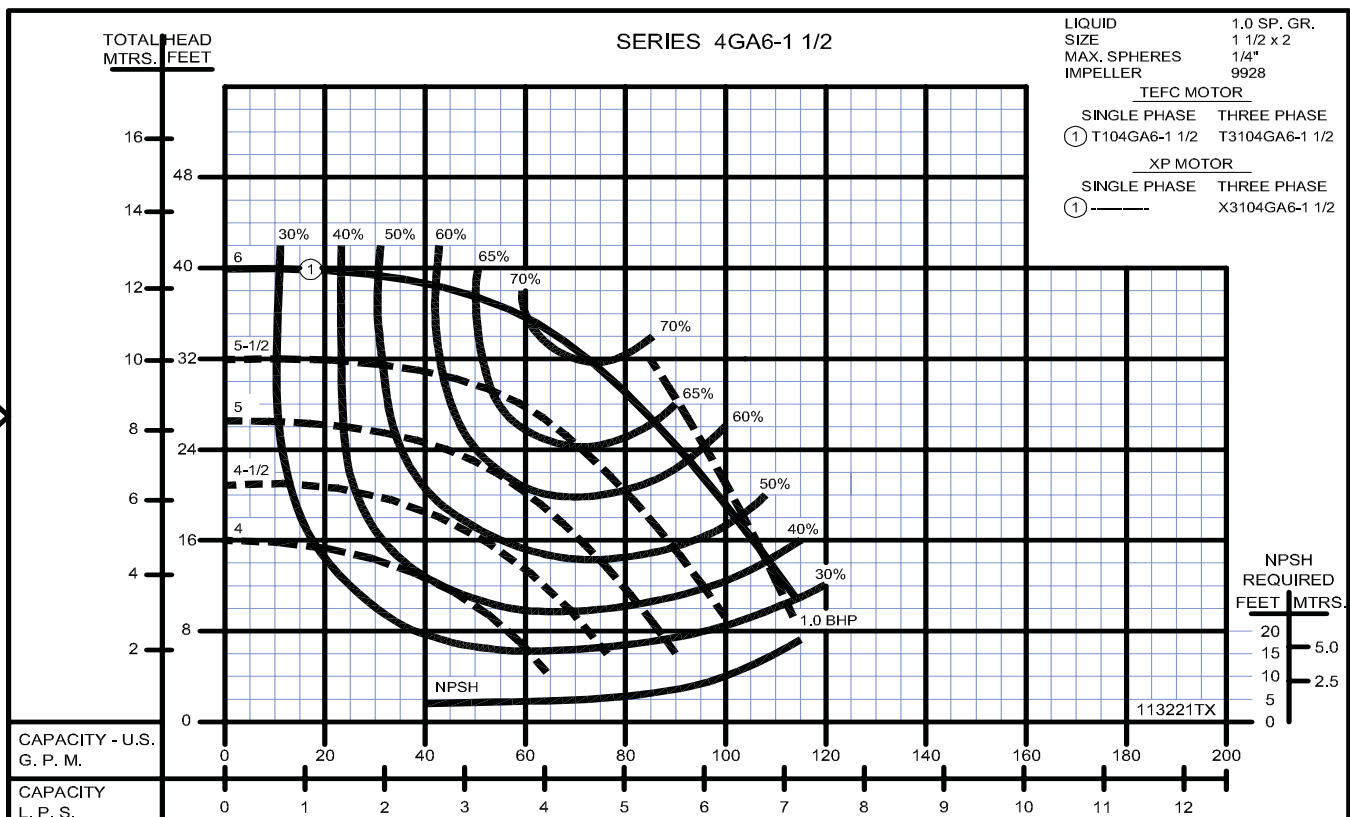
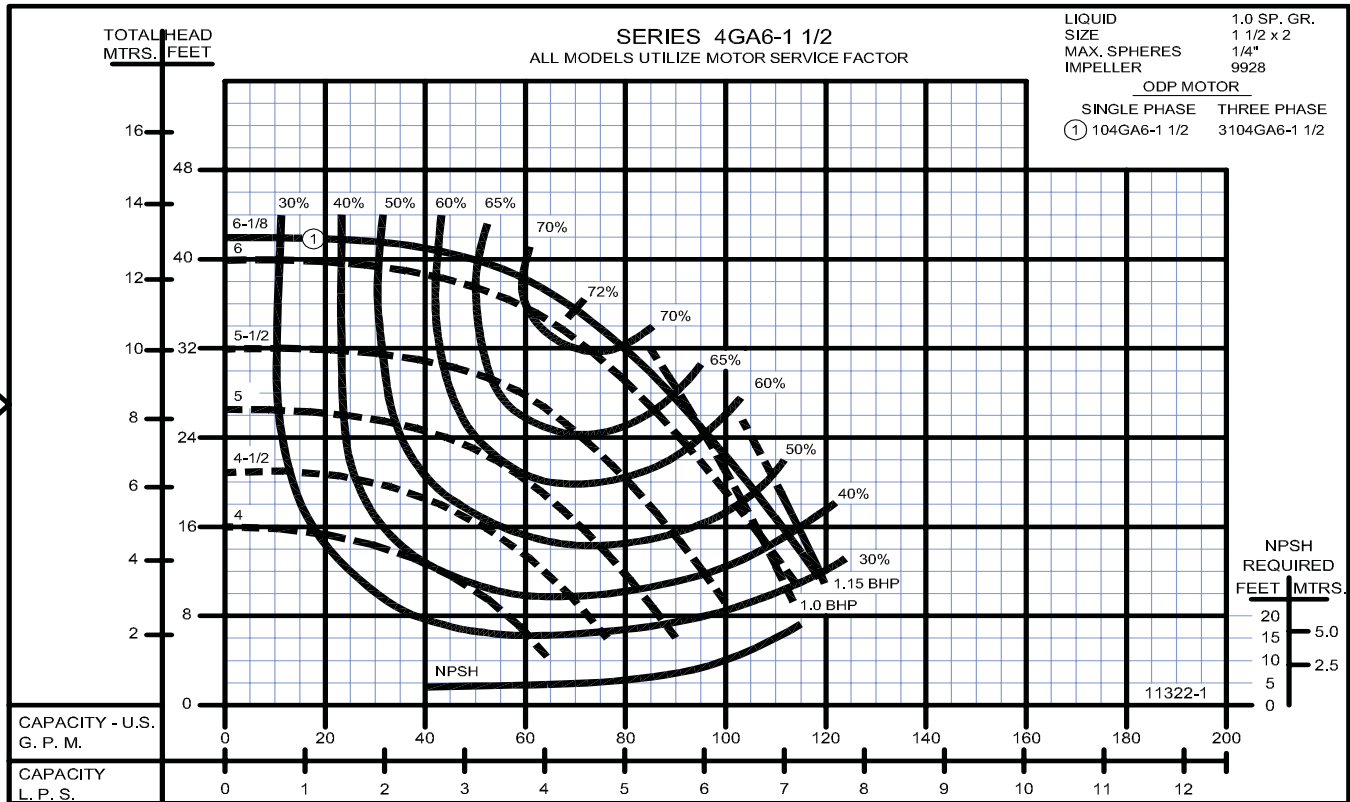

Close Coupled Centrifugal Pumps

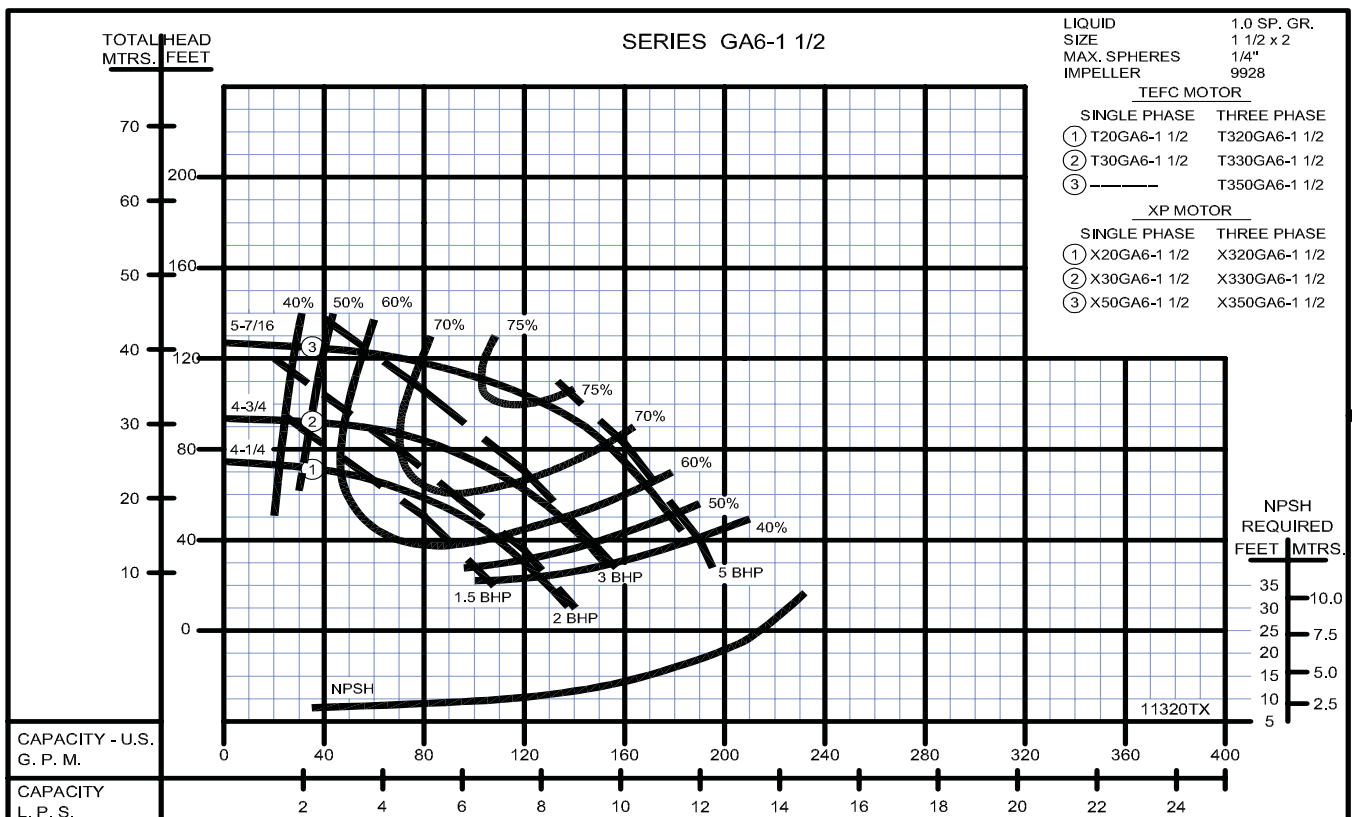

Close Coupled Centrifugal Pumps

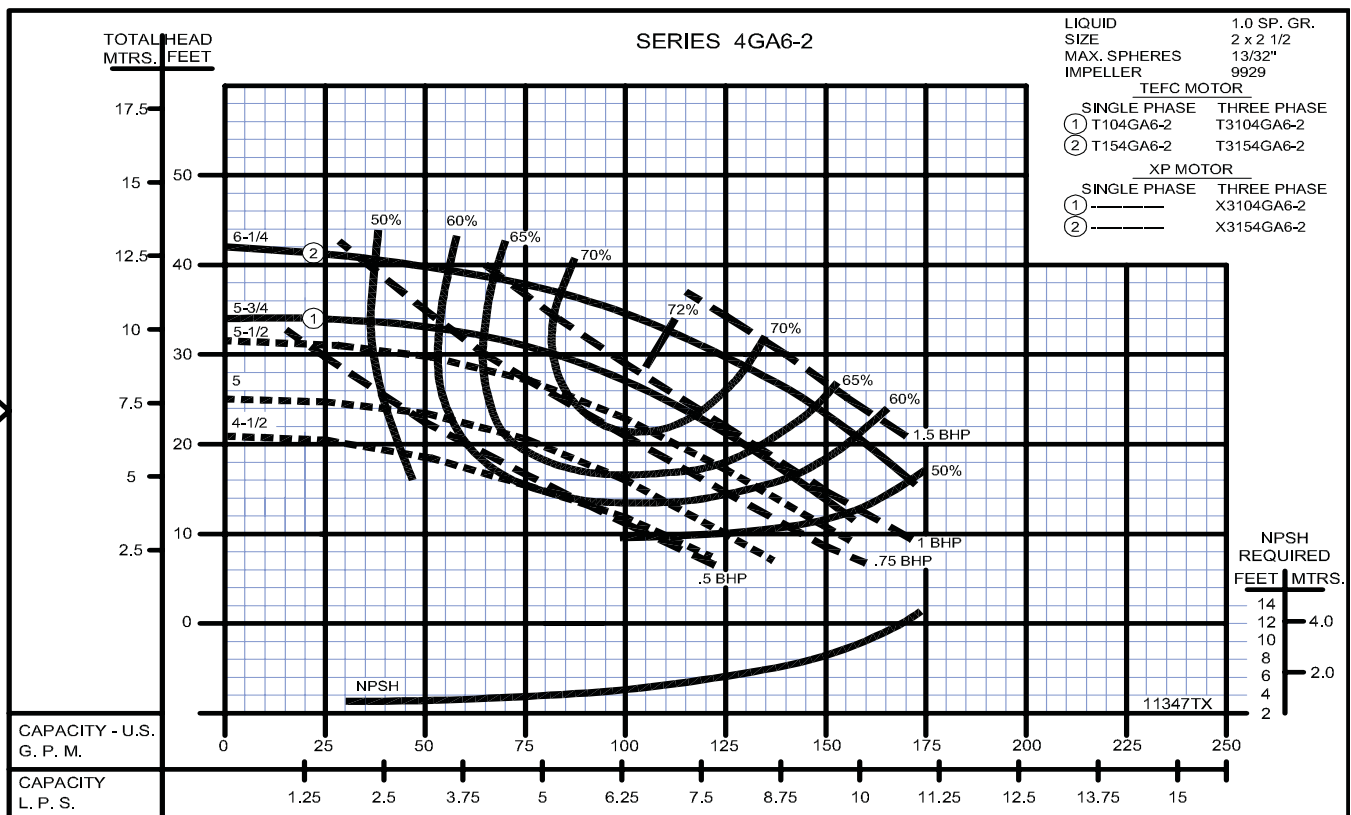
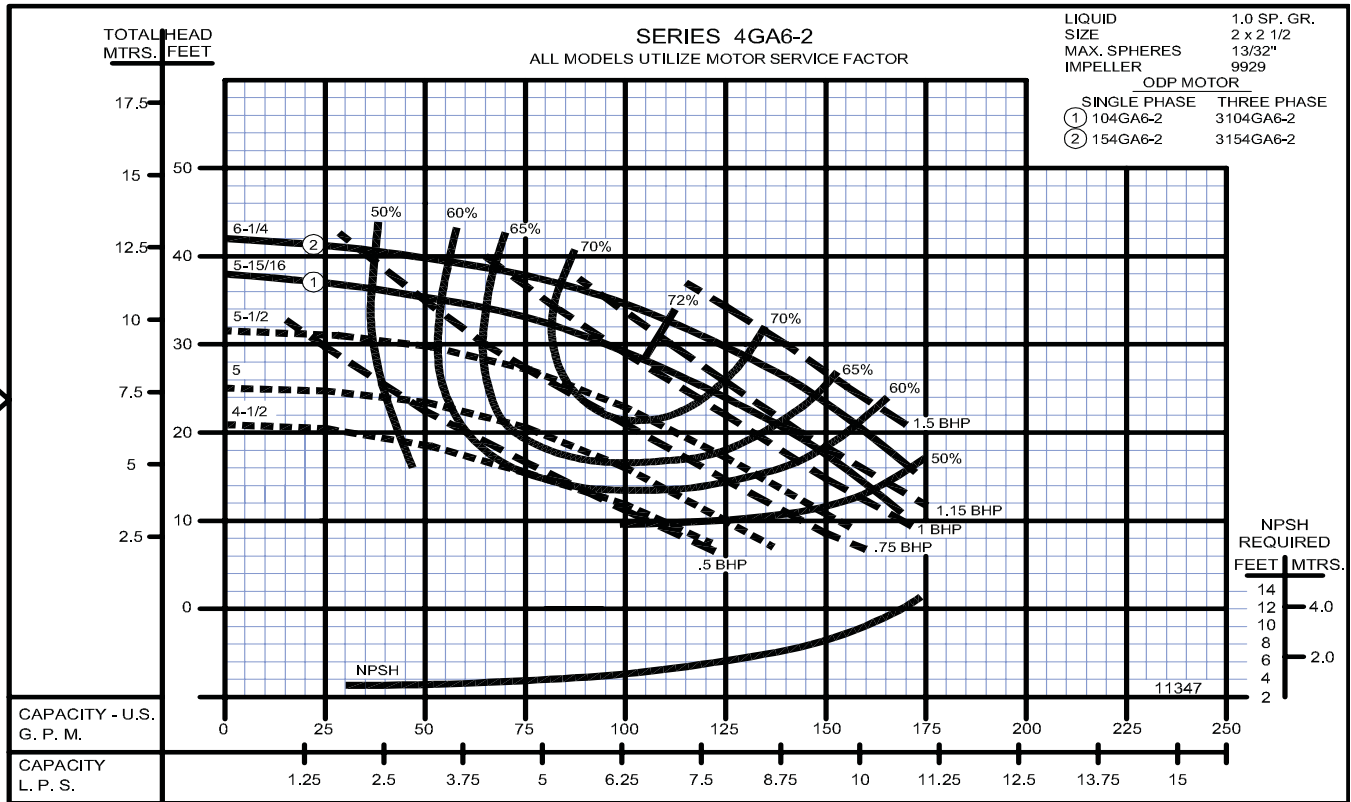

Close Coupled Centrifugal Pumps



Close Coupled Centrifugal Pumps

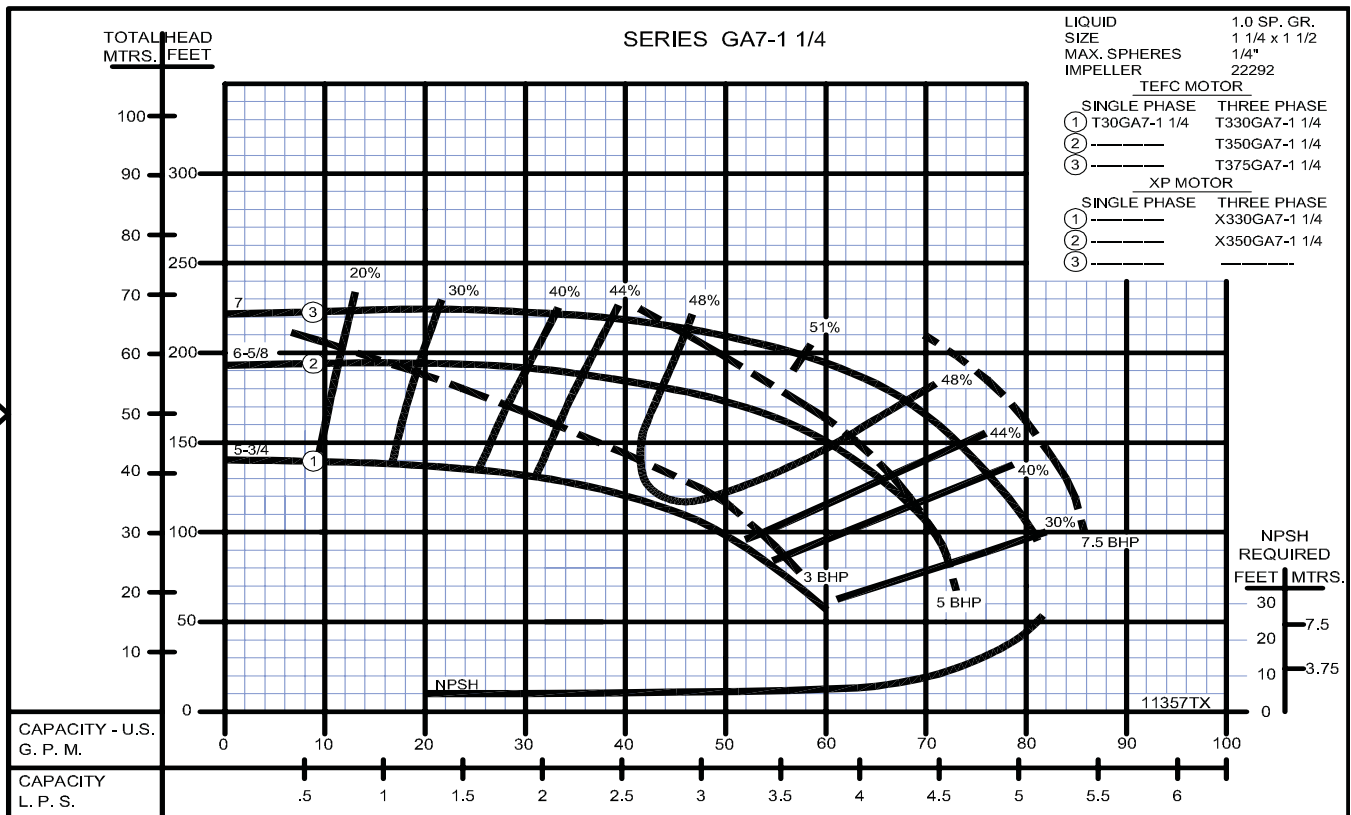
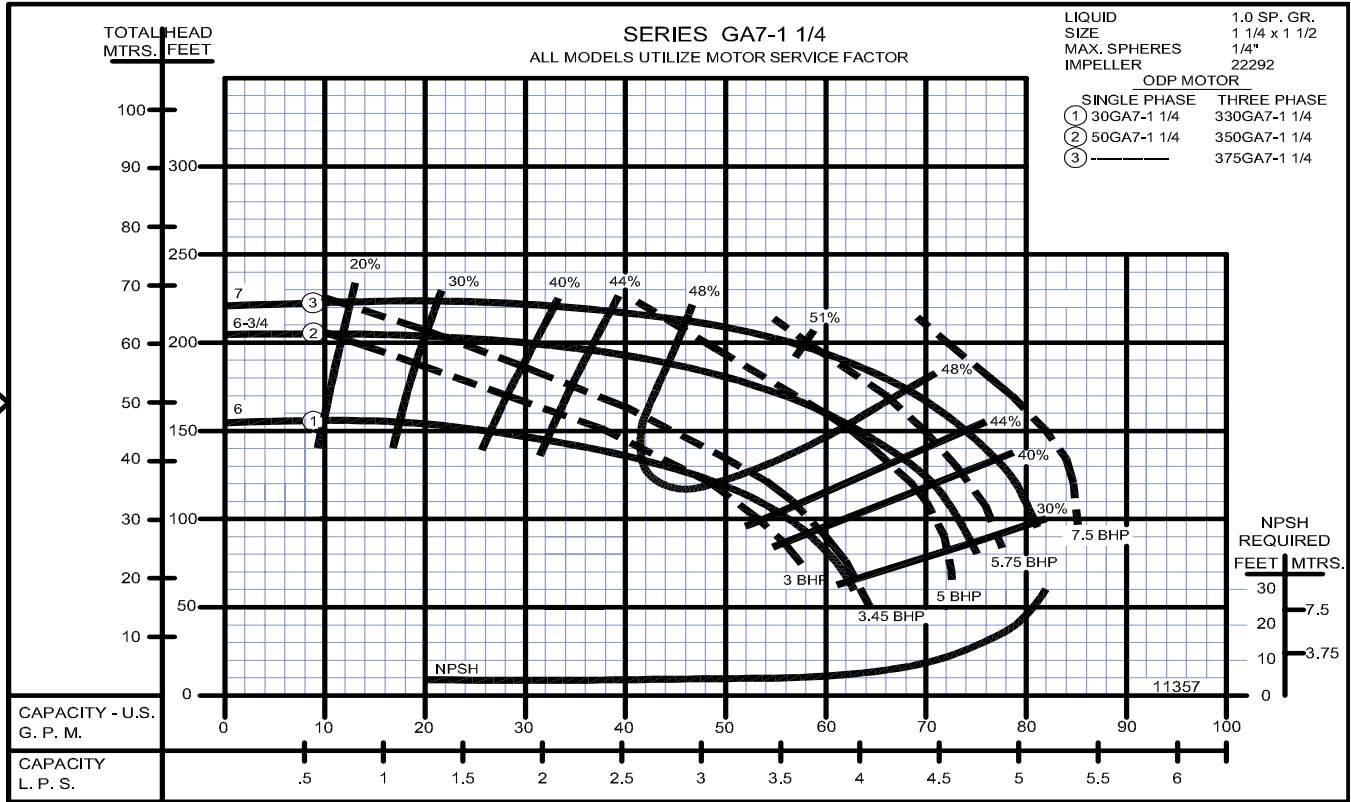

SECTION 2A
PAGE 36
DATE 1/06



PUMPS & SYSTEMS

A Crane Co. Company

USA: (937) 778-8947 • Canada: (905) 457-6223 • International: (937) 615-3598

Close Coupled Centrifugal Pumps

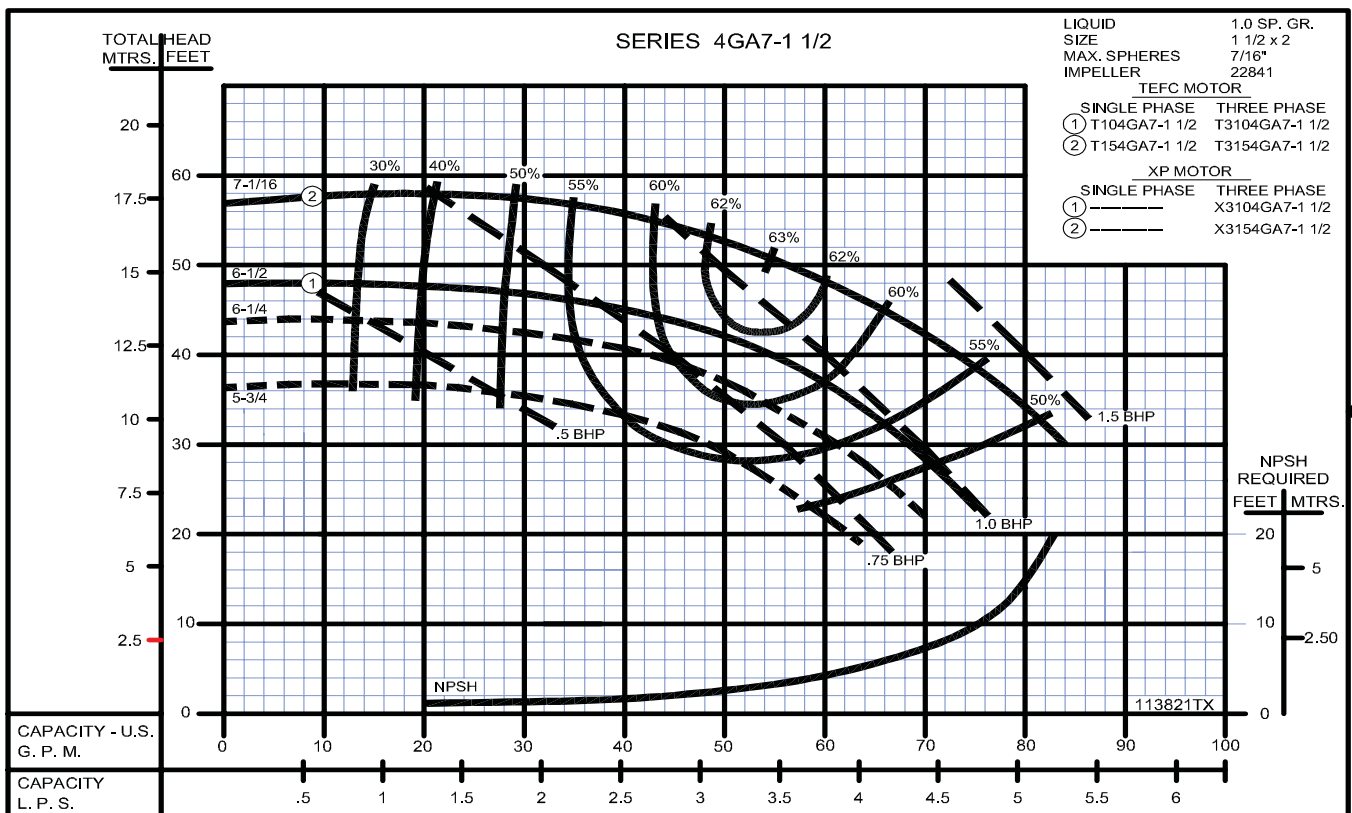
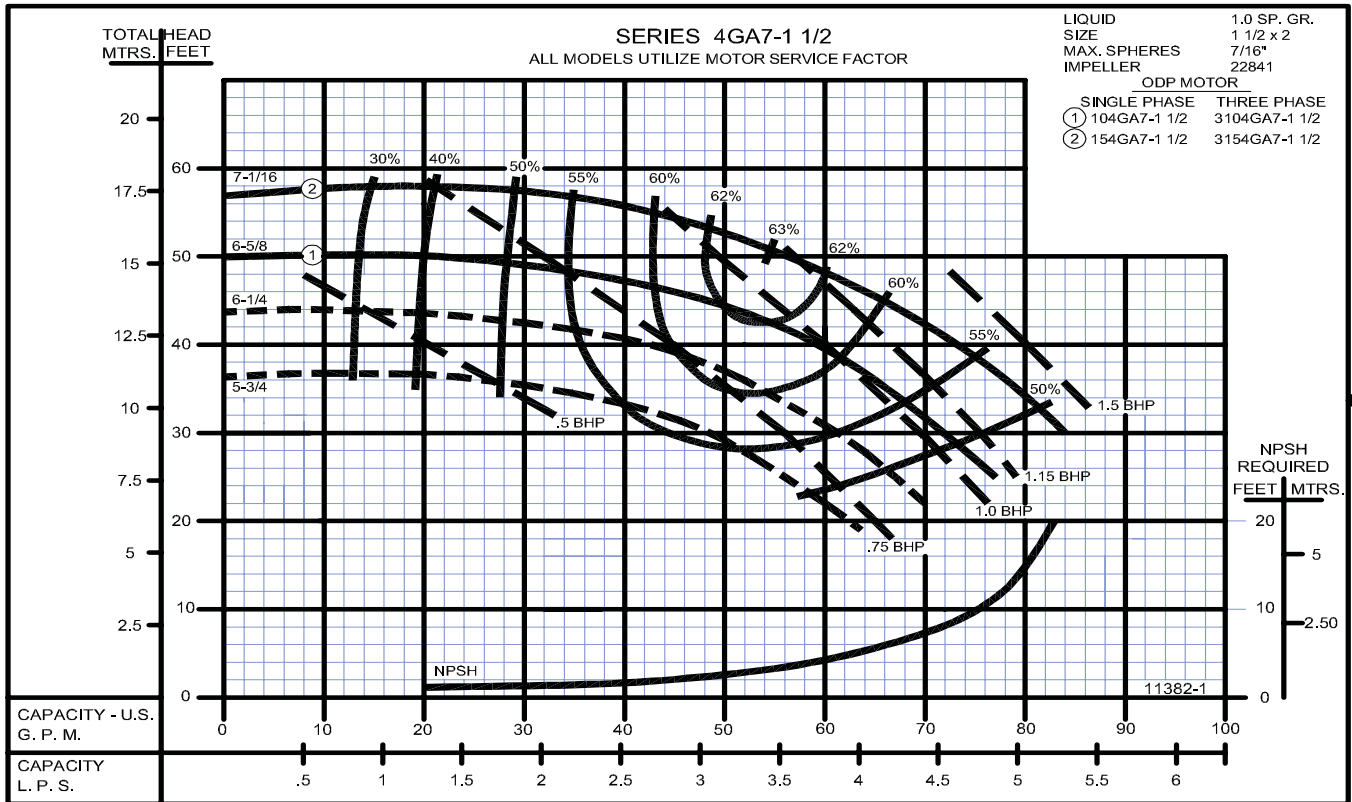

Close Coupled Centrifugal Pumps

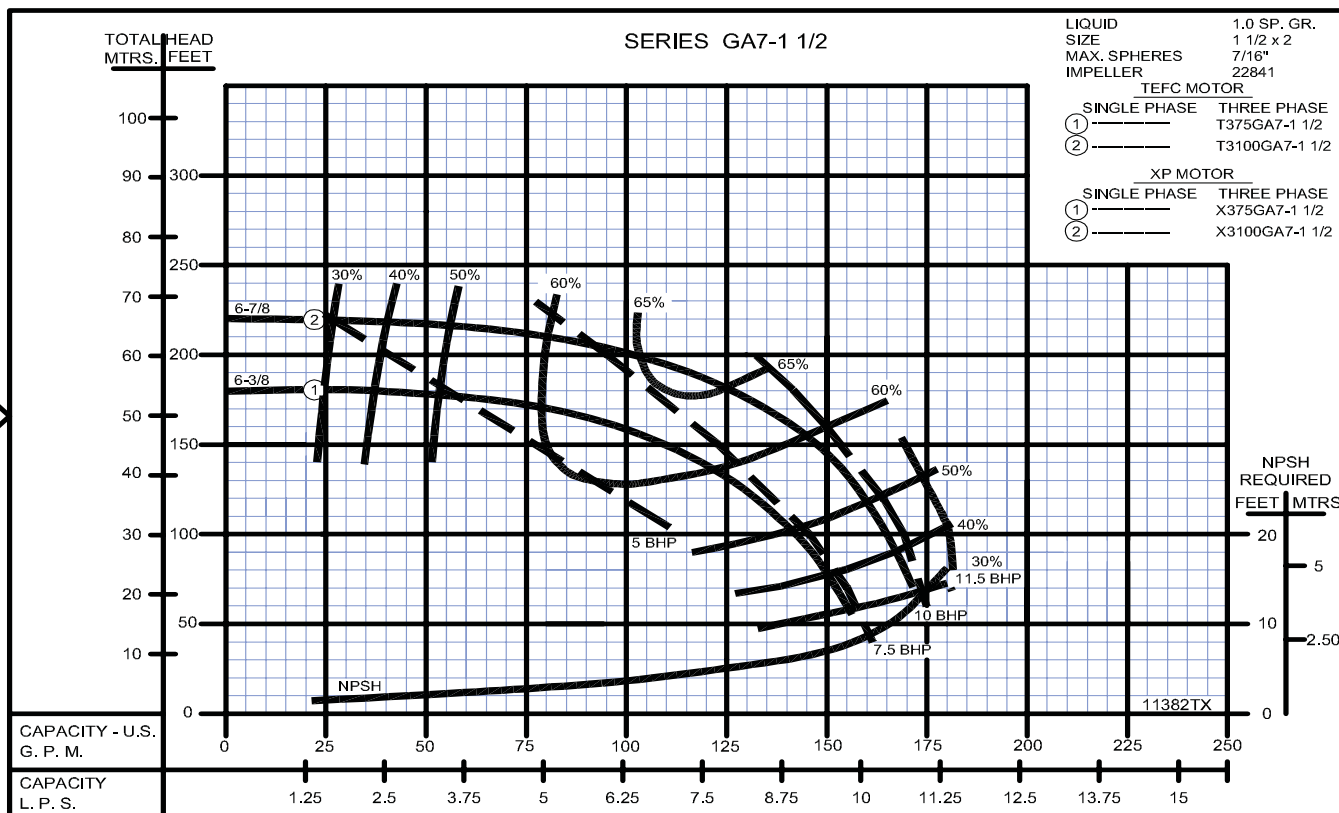

Close Coupled Centrifugal Pumps

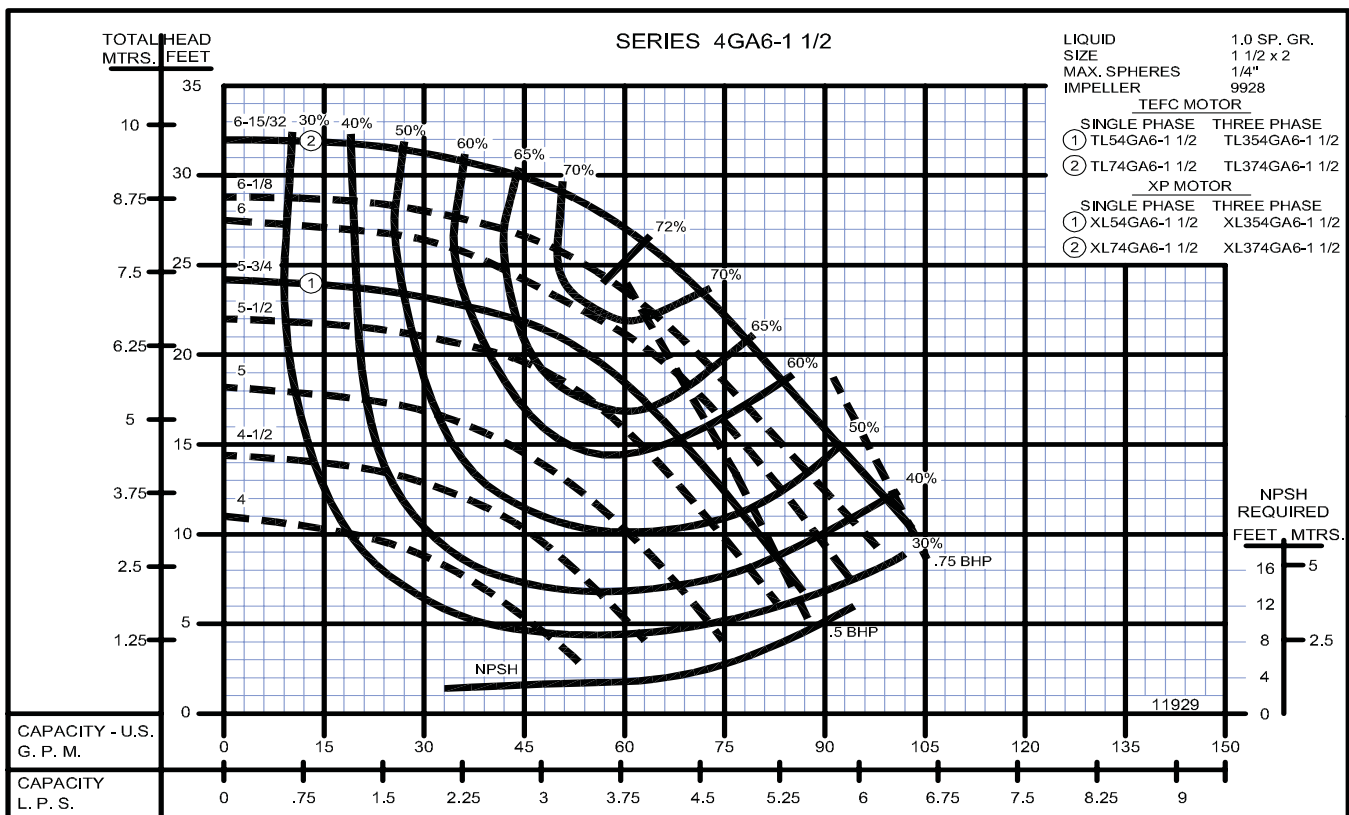
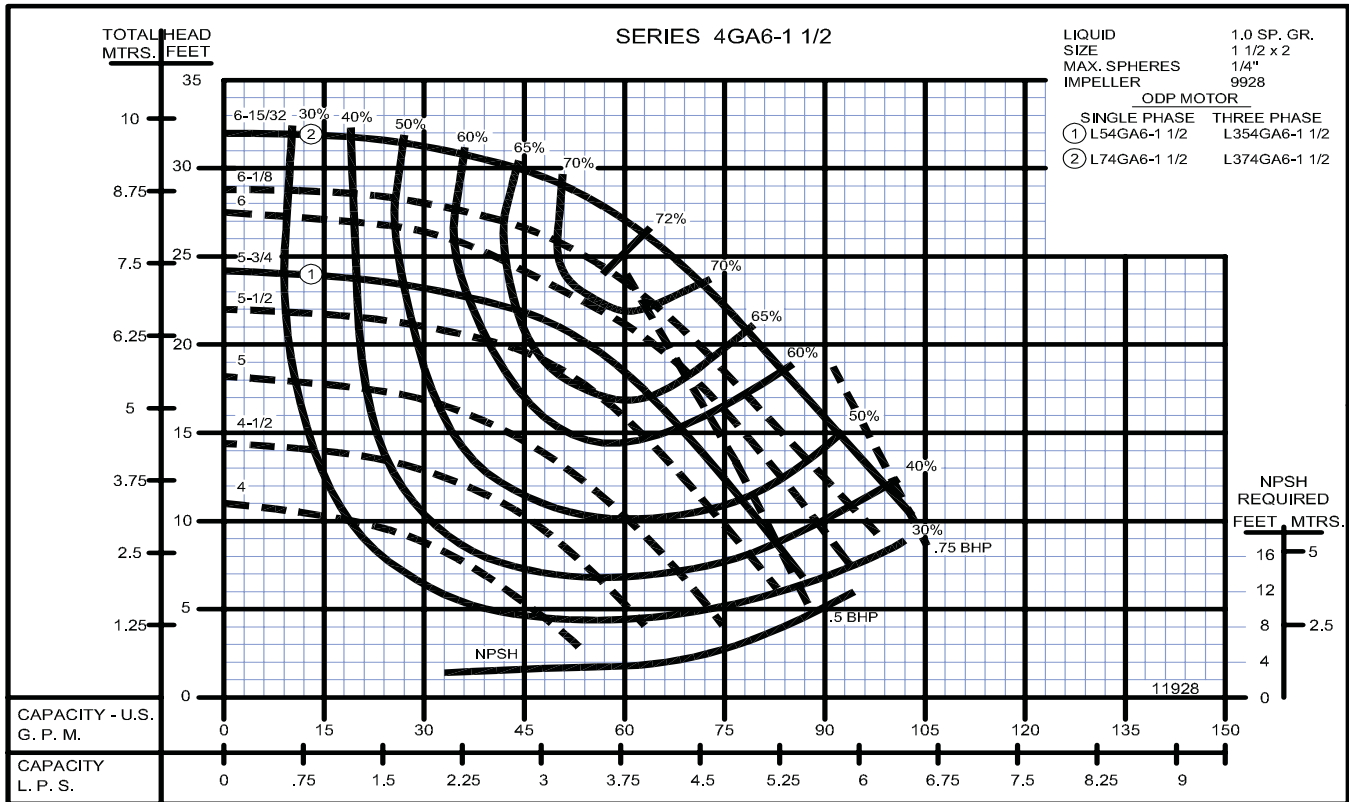

Close Coupled Centrifugal Pumps



Close Coupled Centrifugal Pumps

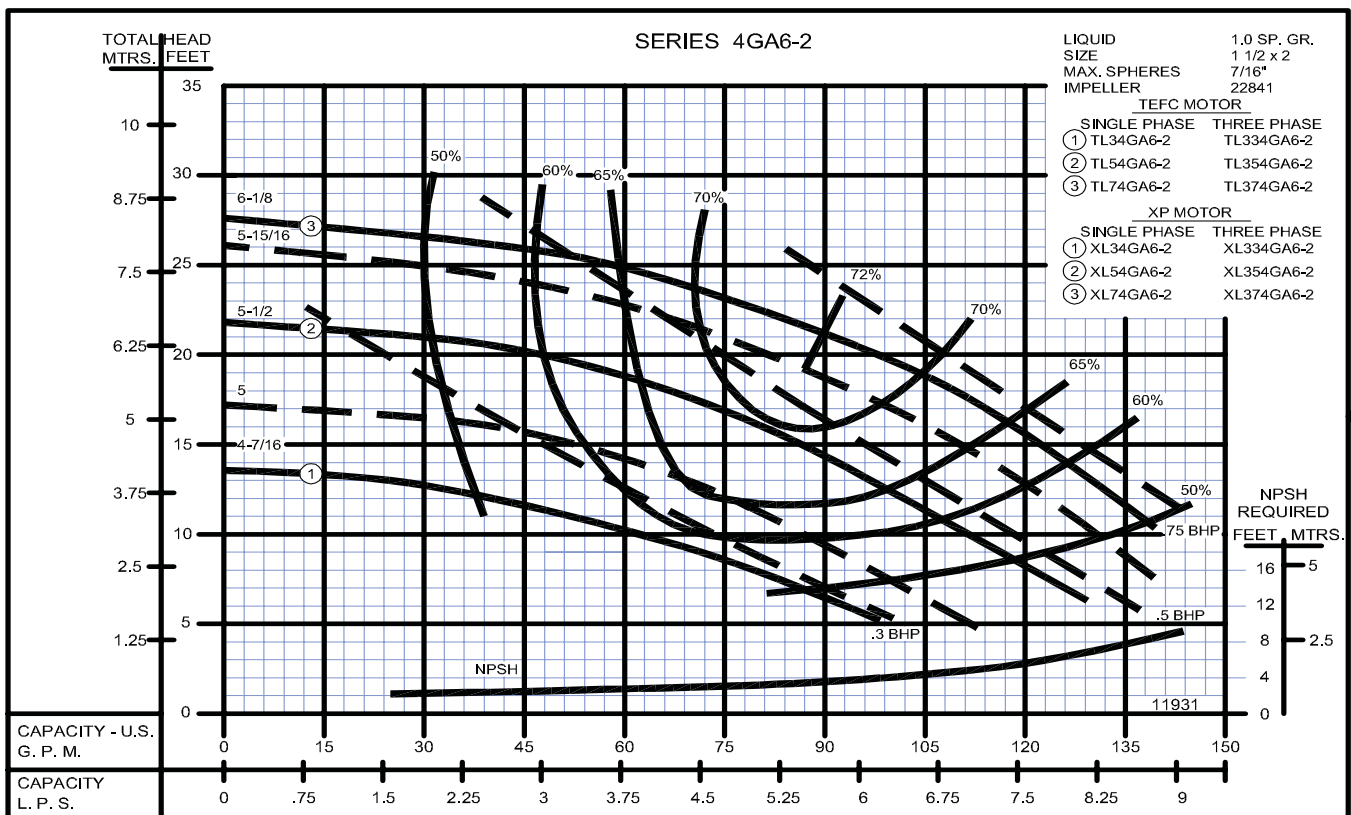
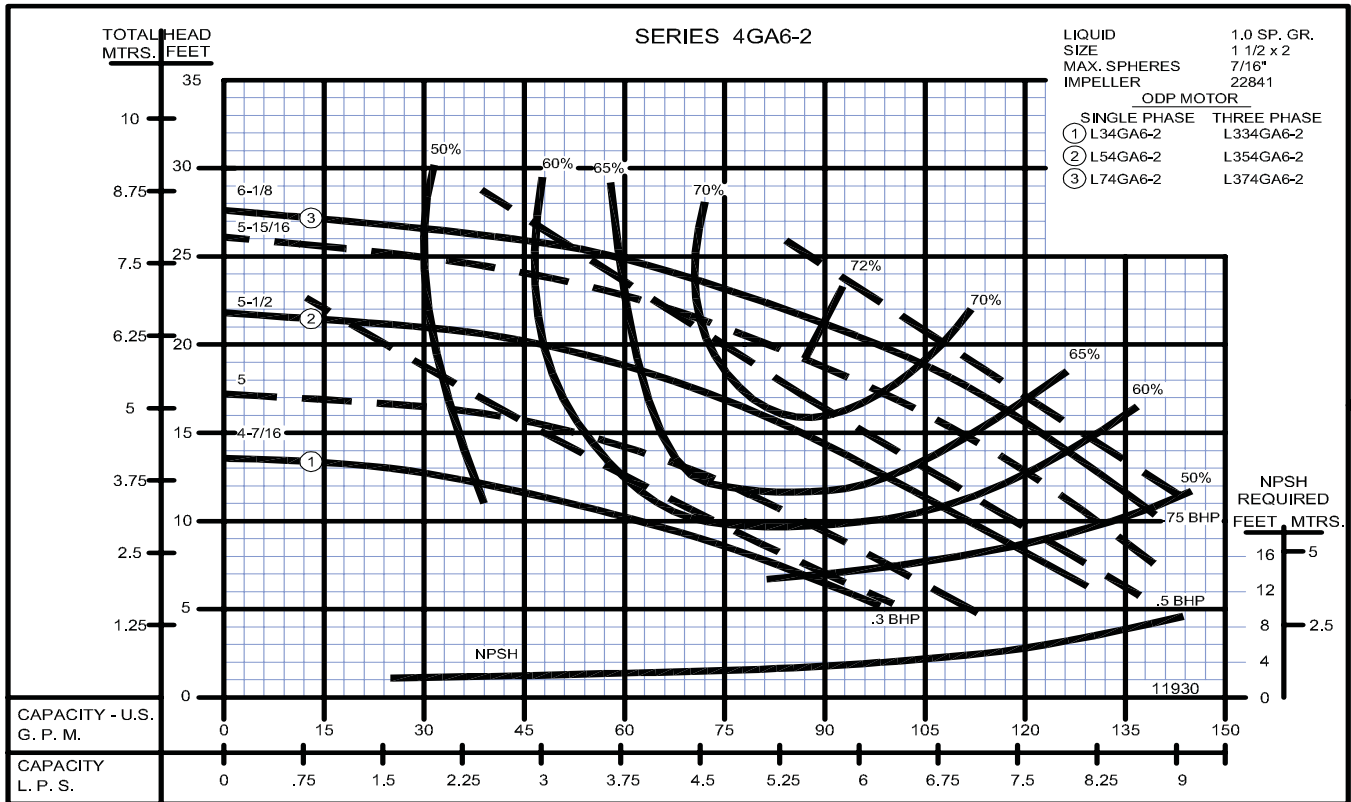

Close Coupled Centrifugal Pumps

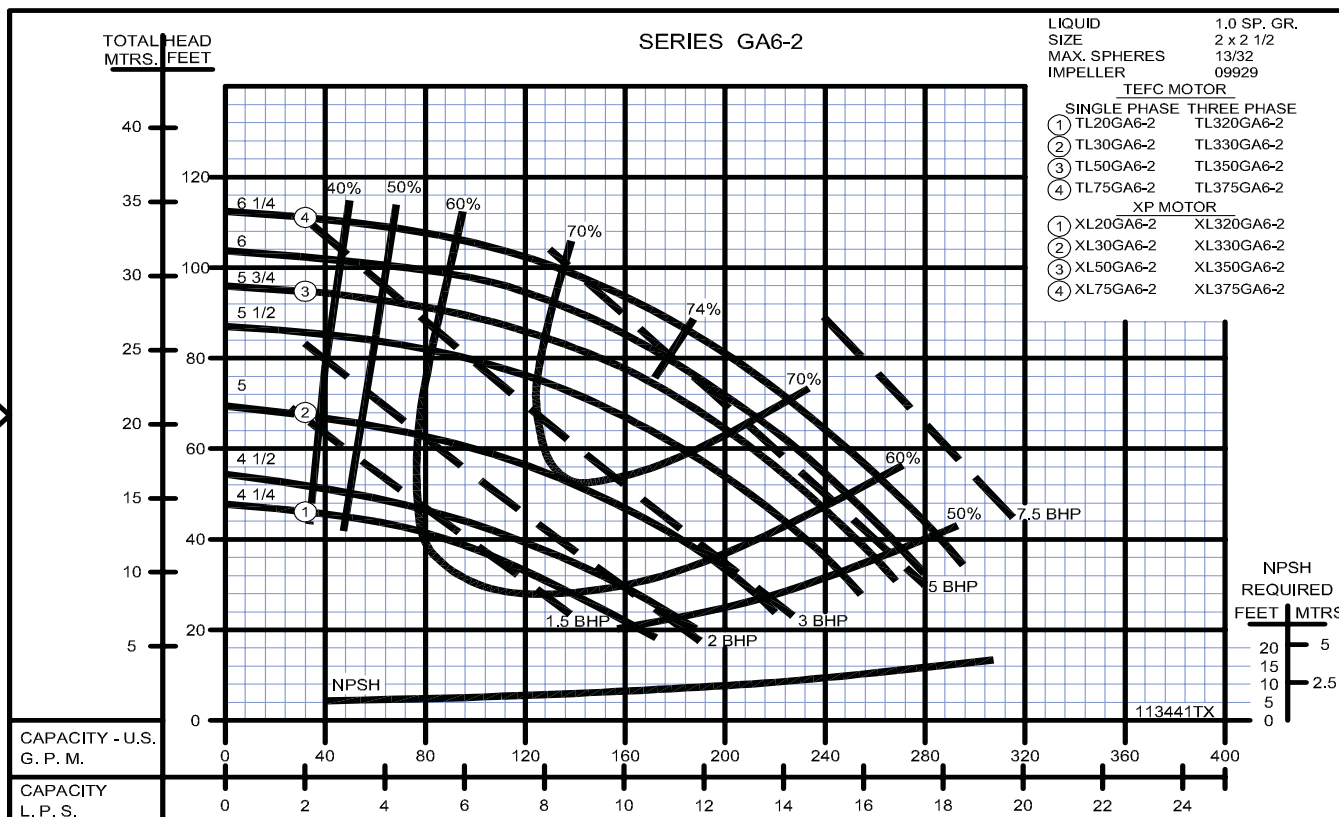
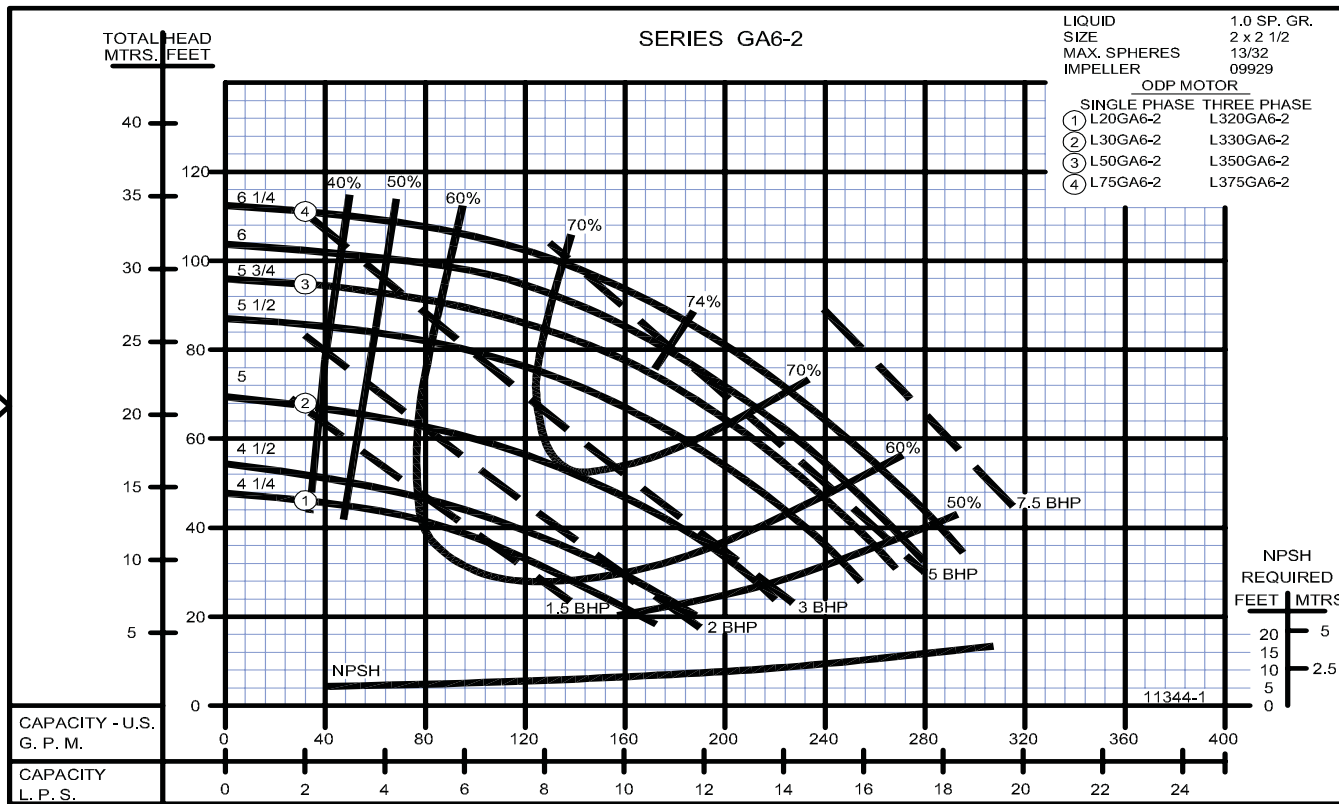

Close Coupled Centrifugal Pumps

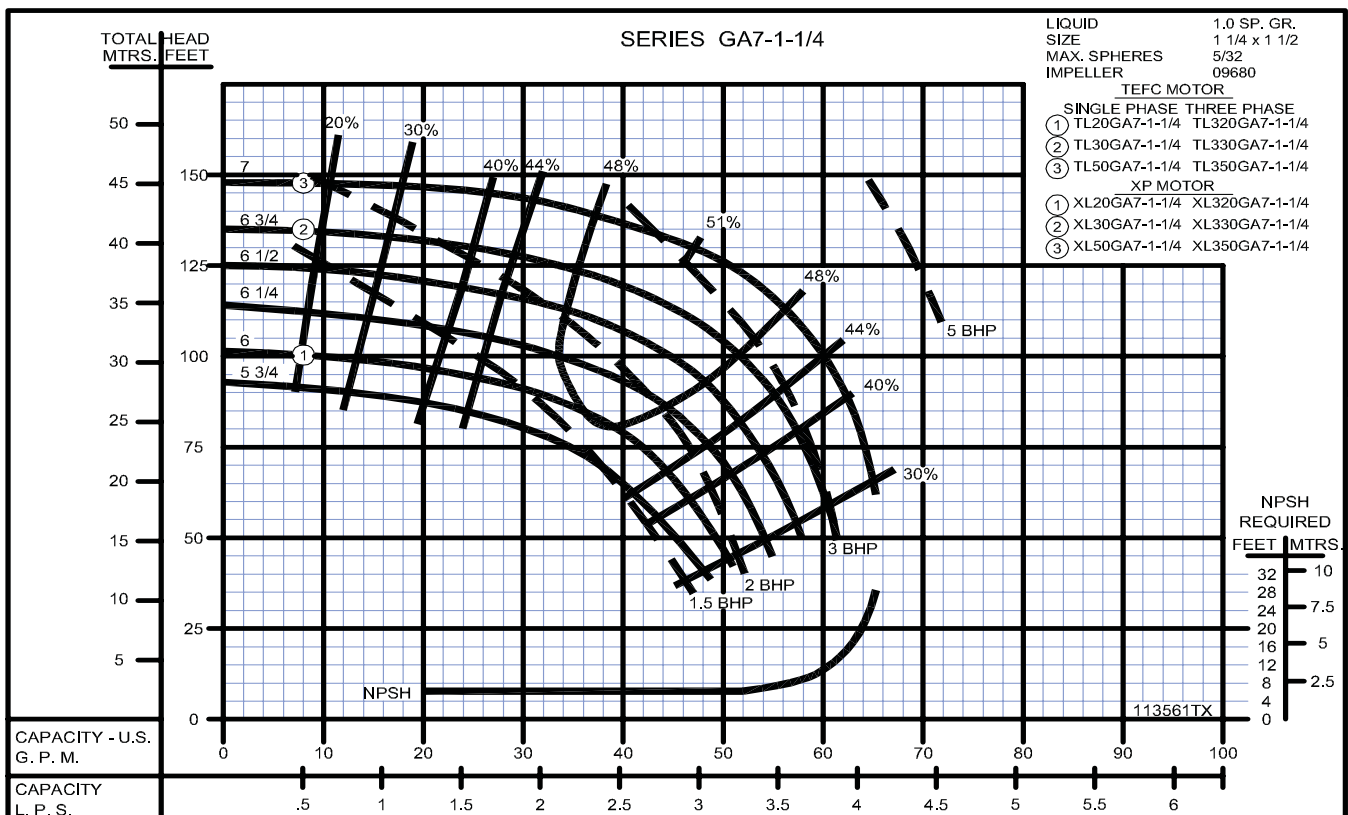
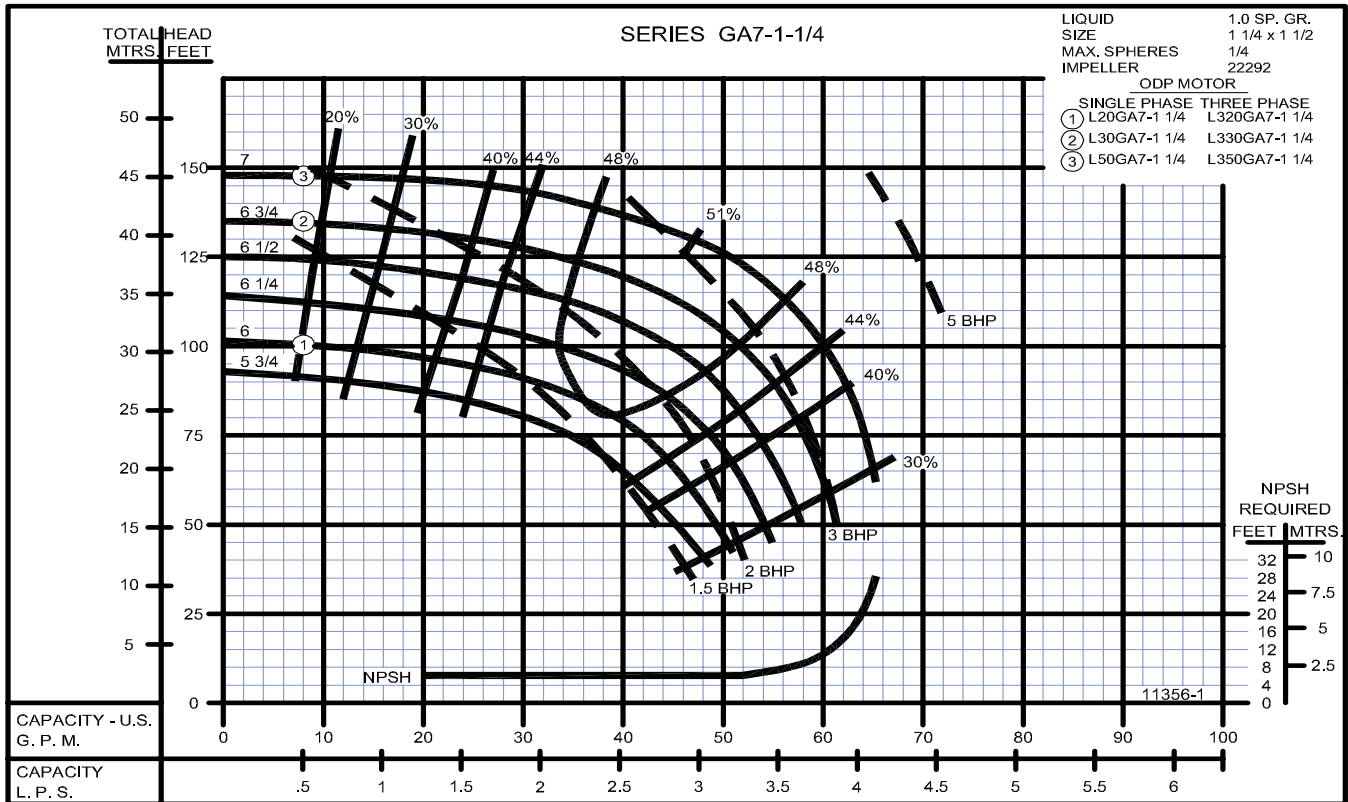

Close Coupled Centrifugal Pumps

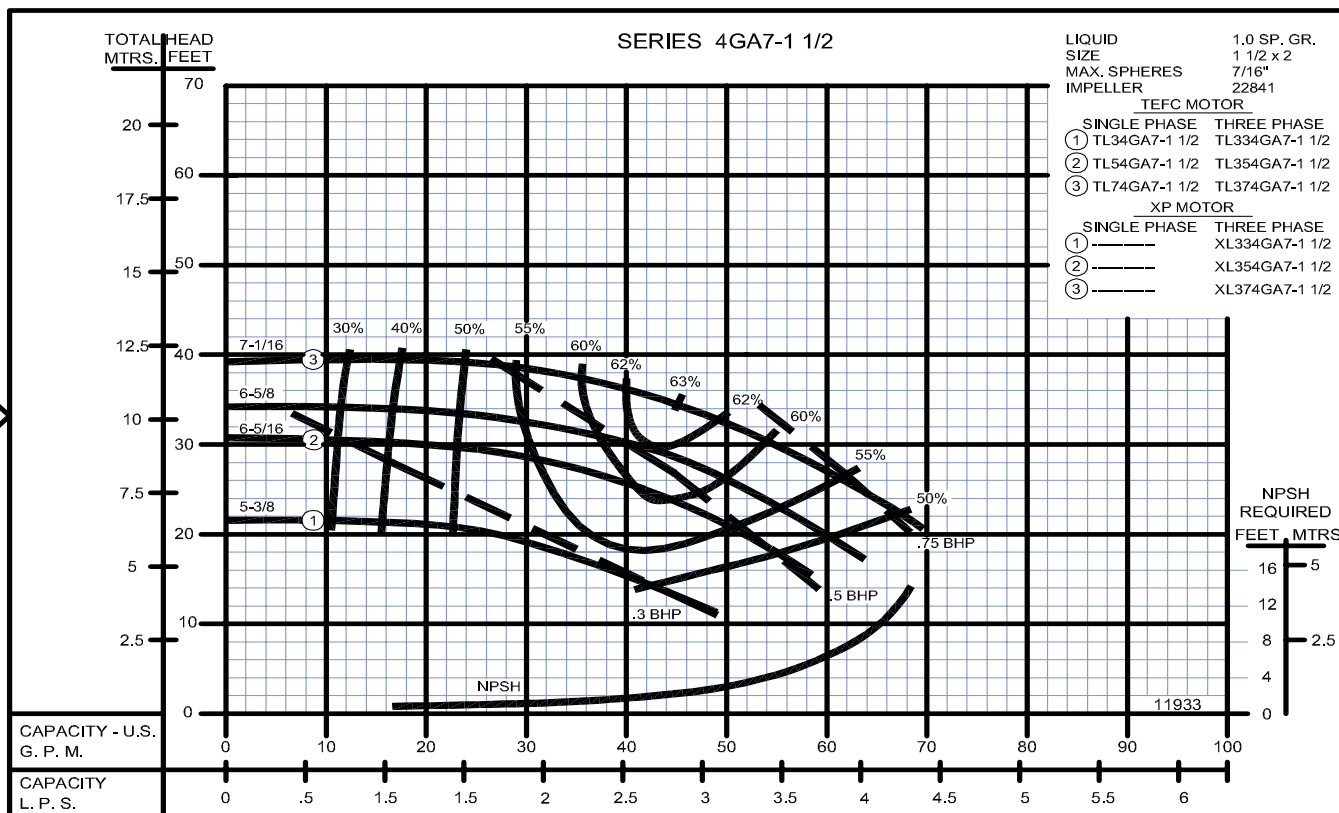
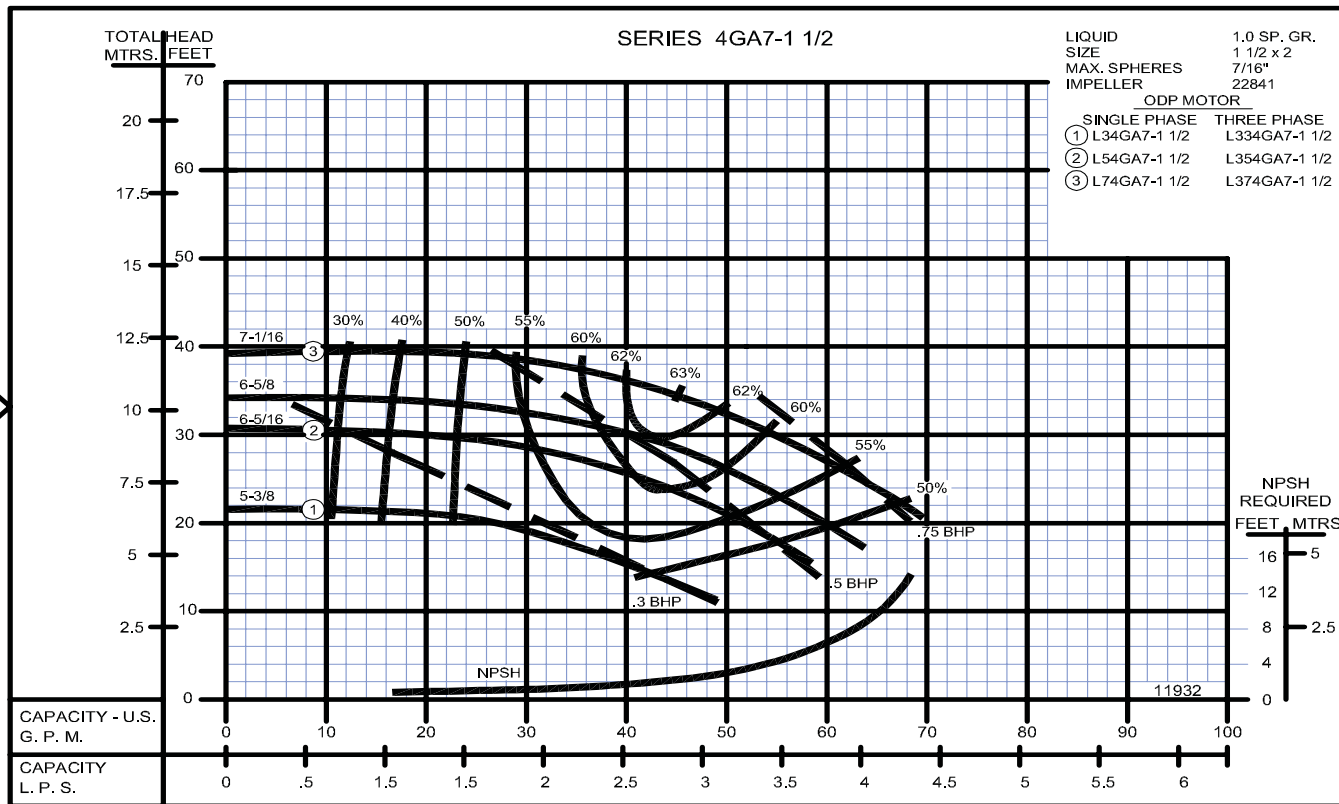

Close Coupled Centrifugal Pumps

