

Close Coupled Centrifugal Pumps

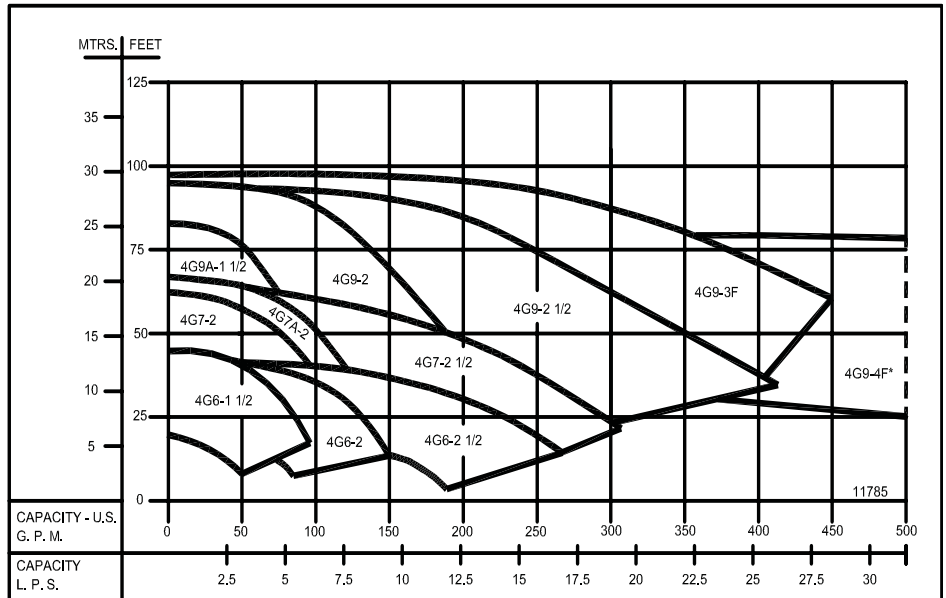

1750 RPM - 60Hz.
 CAPACITIES TO 1100 GPM (69.4 LPS)
 HEADS TO 95 FEET (29 M)

* FOR CAPACITIES ABOVE 500 GPM
 SEE 4G9-4F CURVE.



1450 RPM - 50Hz.
 CAPACITIES TO 340 GPM (21.5 LPS)
 HEADS TO 63 FEET (19 M)

Individual performance curves should be
 checked for final selection.

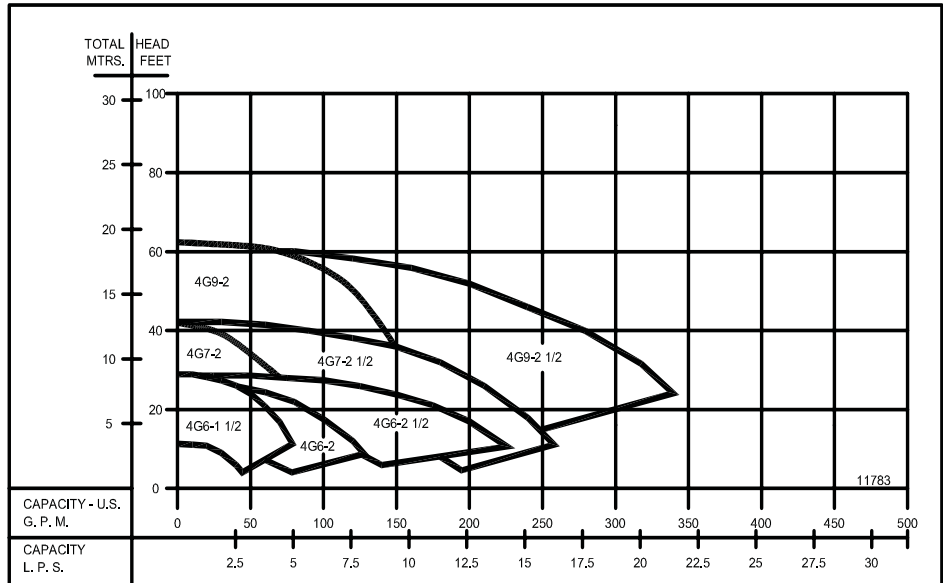

Close Coupled Centrifugal Pumps



3500 RPM - 60Hz.
CAPACITIES TO 960 GPM (60.6 LPS)
HEADS TO 380 FEET (116 M)



2900 RPM - 50Hz.
CAPACITIES TO 630 GPM (39.7 LPS)
HEADS TO 265 FEET (80.8 M)

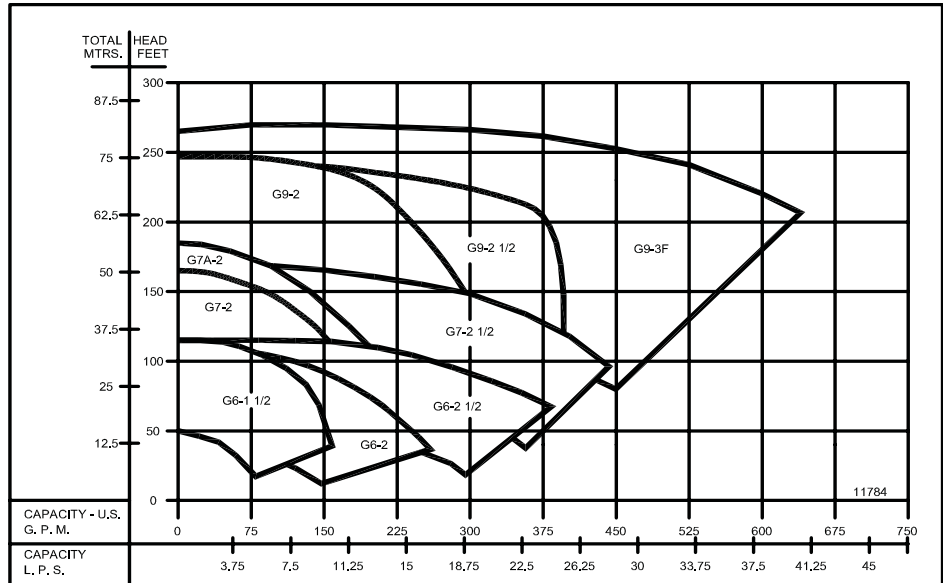

Individual performance curves should be checked for final selection.

Close Coupled Centrifugal Pumps



1. RADIAL SPLIT CASING DESIGN

Casing is close grain iron of 30,000 p.s.i. minimum tensile strength. Back pull-out design eliminates the need to disturb piping should the pump ever require service - the casing stays in the line. Centerline discharge. Stud mounted casing assures positive alignment and allows rotation of discharge to eight different positions. Openings are provided for test gauges, for venting and for draining the pump.

2. ENCLOSED BRONZE IMPELLER

Enclosed bronze impeller is of latest hydraulic design for maximum efficiency. It is balanced for vibration free operation. Precision fit to shaft and double-locked with key and cap screw.

3. REPLACEABLE CASING WEAR RING

Prevents wear on casing and is easy to replace.

4. MECHANICAL SHAFT SEAL

Mechanical Shaft Seal is self-adjusting for temperatures up to 225°F (107°C) and pressures to 150 psi (1034kpa). Has ceramic seat and carbon seal faces for long trouble-free service. Special seals are available for higher temperatures and fluids other than water. Tapped opening is provided in the seal chamber for flushing seal faces.

MAXIMUM OPERATING CONDITIONS

| | |
|-------------------------------|-------------------|
| Maximum Pumping Temperature* | 225°F (107°C) |
| Maximum inlet Pressure | 100 PSI (690kpa) |
| Maximum Case Working Pressure | 200 PSI (1379kpa) |

* FOR STANDARD BUNA-N SEAL

MATERIALS OF CONSTRUCTION

| Part | Brone Fitted | All Bronze | All Iron |
|------------------|-------------------------------|-------------------------------|-------------------------------|
| Adapter | Cast Iron | Bronze | Cast Iron |
| Casing | Cast Iron | Bronze | Cast Iron |
| Casing Wear Ring | Bronze | Bronze | Steel |
| Shaft | Steel | Steel | Steel |
| Shaft Sleeve | Bronze | Bronze | #316 Stainless |
| Impeller | Bronze | Bronze | Cast Iron |
| Shaft Seal | Carbon-Ceramic SS - Buna-N | Carbon-Ceramic SS - Buna-N | Carbon-Ceramic SS - Buna-N |

5. BRONZE SHAFT SLEEVE

Gasketed and keyed hook-type sleeve protects shaft wear and corrosion in seal area.

6. MOTORS

The standard Type JM motors supplied with these pumps offer the advantages of quiet operation, controlled shaft deflection for longer mechanical seal life and bearings sized to provide good service life. All motors are **supplied by** manufacturers providing field service facilities.

7. INTERCHANGEABILITY

The complete liquid end of any size pump is interchangeable between motors on close-coupled pumps and the BURKS power frames of comparable size providing inventory flexibility, plus an option for handling emergency service.

8. FACTORY TESTED

After careful assembly and inspection, EVERY pump is factory tested and will meet Hydraulic Institute standards.

FOR TEMPERATURES TO 500°F (260°C).

All models, with the exception of the G7-2-1/2 and all G9 series pumps are available in a Jacketed Seal Cavity design for pumping hot oil, hot water and heat transfer fluids in common use in high temperature heating or cooling applications. This feature greatly extends seal life in high temperature applications. To order, add suffix "MJ" to pump catalog number for temperatures below 400°F (204°C) and add suffix "MJK" to pump catalog number for temperatures over 400°F (204°C). Example: G6-1-1/2MJ. See Section on High Temperature Pumps for more information.

SUCTION & DISCHARGE SIZES

| * SERIES | SUCTION (in) | DISCHARGE (in) |
|-------------------|--------------|----------------|
| G6-1-1/2 | 2 | 1-1/2 |
| G-2 & 2F | 2-1/2 | 2 |
| G6-2-1/2 & 2-1/2F | 3 | 2-1/2 |
| G7-2 & 2F | 2-1/2 | 2 |
| G7A-2 & 2F | 2-1/2 | 2 |
| G7-2-1/2 & 2-1/2F | 3 | 2-1/2 |
| G9-1-1/2 | 2 | 1-1/2 |
| G9-2 & 2F | 2-1/2 | 2 |
| G9-2-1/2 & 2-1/2F | 3 | 2-1/2 |
| G9-3F & G9A-3F | 4 | 3 |
| G9-4F | 5 | 4 |

*F Suffix Denotes ANSI 125# Flat Face Flanges

Series: 4G6-1½, 4G6-2, 4G6-2½

G6-1½, G6-2, G6-2½

Dimensions with Screwed NPT Casing



Close Coupled Centrifugal Pumps

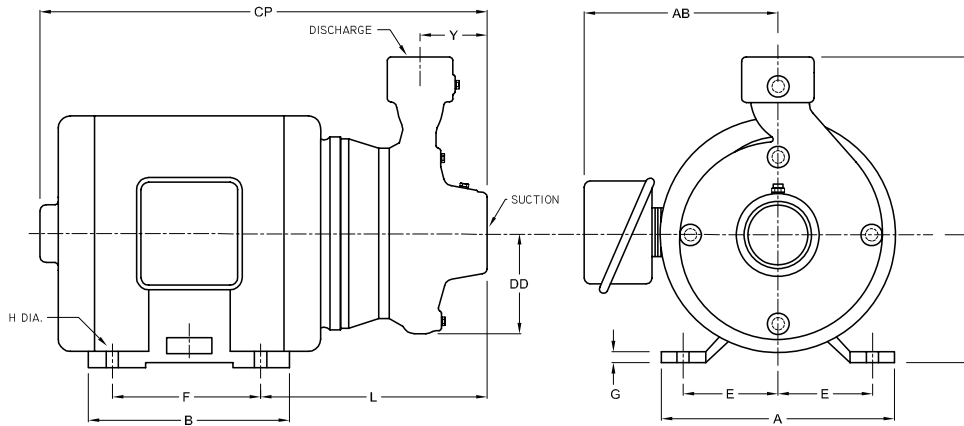

DIMENSIONS IN INCHES

| MODEL | | HP | MOTOR FRAME SIZE | DISC NPT (in) | SUCT NPT (in) | A | AB | B | CP | D | DD | E | F | G | H | L | X | Y |
|----------------------------|-----------|----|------------------|--------------------------------|---------------------------------|-----|----------------------------------|----|----------------------------------|----|-------------------------------|-------------------------------|--------------------------------|--------------------------------|--------------------------------|---------------------------------|--------------------------------|---------------------------------|
| 1 Phase | 3 Phase | | | | | | | | | | | | | | | | | |
| 1750 & 1450 RPM | | | | | | | | | | | | | | | | | | |
| 104G6-1½ | 3104G6-1½ | 1 | 143JM | 1½ | 2 | 7 | 8 ¹⁵ / ₁₆ | 5 | 15 ⁷ / ₈ | 3½ | 4 ¹ / ₈ | 2¾ | 4 | ¾ | 1 ¹ / ₃₂ | 9 ⁷ / ₁₆ | 7¼ | 2¾ |
| 104G6-2 | 3104G6-2 | 1 | 143JM | 2 | 2½ | 7 | 8 ¹⁵ / ₁₆ | 5 | 16 | 3½ | 4½ | 2¾ | 4 | ¾ | 1 ¹ / ₃₂ | 9 ⁹ / ₁₆ | 7½ | 2 ¹³ / ₁₆ |
| 154G6-2 | 3154G6-2 | 1½ | 145JM | | | 7 | 8 ¹⁵ / ₁₆ | 6 | 17 | 3½ | 4½ | 2¾ | 5 | ¾ | 1 ¹ / ₃₂ | 9 ⁹ / ₁₆ | 7½ | 2 ¹³ / ₁₆ |
| 104G6-2½ | 3104G6-2½ | 1 | 143JM | 2½ | 3 | 7 | 8 ¹⁵ / ₁₆ | 5 | 16 ¹¹ / ₁₆ | 3½ | 5 | 2¾ | 4 | ¾ | 1 ¹ / ₃₂ | 10¼ | 8¼ | 3 ⁵ / ₁₆ |
| 154G6-2½ | 3154G6-2½ | 1½ | 145JM | | | 7 | 8 ¹⁵ / ₁₆ | 6 | 17 ¹¹ / ₁₆ | 3½ | 5 | 2¾ | 5 | ¾ | 1 ¹ / ₃₂ | 10¼ | 8¼ | 3 ⁵ / ₁₆ |
| 204G6-2½ | ----- | 2 | 182JM | | | 8¾ | 9 ⁷ / ₈ | 5¾ | 8½ | 4½ | 5 | 3¾ | 4½ | ½ | 1 ³ / ₃₂ | 11 | 8¼ | 3 ⁵ / ₁₆ |
| ----- | 3204G6-2½ | 2 | 145JM | | | 7 | 8 ¹⁵ / ₁₆ | 6 | 17 ¹¹ / ₁₆ | 3½ | 5 | 2¾ | 5 | ¾ | 1 ¹ / ₃₂ | 10¼ | 8¼ | 3 ⁵ / ₁₆ |
| 3500 & 2900 RPM | | | | | | | | | | | | | | | | | | |
| 15G6-1½ | ----- | 1½ | 143JM | 1½ | 2 | 7 | 8 ¹⁵ / ₁₆ | 5 | 15 ⁷ / ₈ | 3½ | 4 ¹ / ₈ | 2¾ | 4 | ¾ | 1 ¹ / ₃₂ | 9 ⁷ / ₁₆ | 7¼ | 2¾ |
| ----- | 315G6-1½ | 1½ | 143JM | | | 7 | 8 ¹⁵ / ₁₆ | 5 | 15 ⁷ / ₈ | 3½ | 4 ¹ / ₈ | 2¾ | 4 | ¾ | 1 ¹ / ₃₂ | 9 ⁷ / ₁₆ | 7¼ | 2¾ |
| 20G6-1½ | ----- | 2 | 145JM | | | 7 | 8 ¹⁵ / ₁₆ | 6 | 16 ⁷ / ₈ | 3½ | 4 ¹ / ₈ | 2¾ | 5 | ¾ | 1 ¹ / ₃₂ | 9 ⁷ / ₁₆ | 7¼ | 2¾ |
| ----- | 320G6-1½ | 2 | 145JM | | | 7 | 8 ¹⁵ / ₁₆ | 6 | 16 ⁷ / ₈ | 3½ | 4 ¹ / ₈ | 2¾ | 5 | ¾ | 1 ¹ / ₃₂ | 9 ⁷ / ₁₆ | 7¼ | 2¾ |
| 30G6-1½ | ----- | 3 | 182JM | | | 8¾ | 9 ⁷ / ₈ | 5¾ | 17 ¹¹ / ₁₆ | 4½ | 4 ¹ / ₈ | 3¾ | 4½ | ½ | 1 ³ / ₃₂ | 10 ³ / ₁₆ | 7¼ | 2¾ |
| ----- | 330G6-1½ | 3 | 145JM | | | 7 | 8 ¹⁵ / ₁₆ | 6 | 16 ⁷ / ₈ | 3½ | 4 ¹ / ₈ | 2¾ | 5 | ¾ | 1 ¹ / ₃₂ | 9 ⁷ / ₁₆ | 7¼ | 2¾ |
| 50G6-1½ | ----- | 5 | 184JM | | | 8¾ | 9 ⁷ / ₈ | 6¾ | 18 ¹¹ / ₁₆ | 4½ | 4 ¹ / ₈ | 3¾ | 5½ | ½ | 1 ³ / ₃₂ | 10 ³ / ₁₆ | 7¼ | 2¾ |
| ----- | 350G6-1½ | 5 | 182JM | | | 8¾ | 9 ⁷ / ₈ | 5¾ | 17 ¹¹ / ₁₆ | 4½ | 4 ¹ / ₈ | 3¾ | 4½ | ½ | 1 ³ / ₃₂ | 10 ³ / ₁₆ | 7¼ | 2¾ |
| ----- | 375G6-1½ | 7½ | 184JM | | | 8¾ | 9 ⁷ / ₈ | 6¾ | 18 ¹¹ / ₁₆ | 4½ | 4 ¹ / ₈ | 3¾ | 5½ | ½ | 1 ³ / ₃₂ | 10 ³ / ₁₆ | 7¼ | 2¾ |
| 20G6-2 | ----- | 2 | 145JM | | | 2 | 2½ | 7 | 8 ¹⁵ / ₁₆ | 6 | 17 | 3½ | 4½ | 2¾ | 5 | ¾ | 1 ¹ / ₃₂ | 9 ⁹ / ₁₆ |
| ----- | 320G6-2 | 2 | 145JM | 7 | 8 ¹⁵ / ₁₆ | | | 6 | 17 | 3½ | 4½ | 2¾ | 5 | ¾ | 1 ¹ / ₃₂ | 9 ⁹ / ₁₆ | 7½ | 2 ¹³ / ₁₆ |
| 30G6-2 | ----- | 3 | 182JM | 8¾ | 9 ⁷ / ₈ | | | 5¾ | 17 ¹³ / ₁₆ | 4½ | 4½ | 3¾ | 4½ | ½ | 1 ³ / ₃₂ | 10 ⁵ / ₁₆ | 7½ | 2 ¹³ / ₁₆ |
| ----- | 330G6-2 | 3 | 145JM | 7 | 8 ¹⁵ / ₁₆ | | | 6 | 17 | 3½ | 4½ | 2¾ | 5 | ¾ | 1 ¹ / ₃₂ | 9 ⁹ / ₁₆ | 7½ | 2 ¹³ / ₁₆ |
| 50G6-2 | ----- | 5 | 184JM | 8¾ | 9 ⁷ / ₈ | | | 6¾ | 18 ¹¹ / ₁₆ | 4½ | 4½ | 3¾ | 5½ | ½ | 1 ³ / ₃₂ | 10 ⁵ / ₁₆ | 7½ | 2 ¹³ / ₁₆ |
| ----- | 350G6-2 | 5 | 182JM | 8¾ | 9 ⁷ / ₈ | | | 5¾ | 17 ¹³ / ₁₆ | 4½ | 4½ | 3¾ | 4½ | ½ | 1 ³ / ₃₂ | 10 ⁵ / ₁₆ | 7½ | 2 ¹³ / ₁₆ |
| ----- | 375G6-2 | 7½ | 184JM | 8¾ | 9 ⁷ / ₈ | | | 6¾ | 18 ¹¹ / ₁₆ | 4½ | 4½ | 3¾ | 5½ | ½ | 1 ³ / ₃₂ | 10 ⁵ / ₁₆ | 7½ | 2 ¹³ / ₁₆ |
| ----- | 3100G6-2 | 10 | 213JM | 10 ³ / ₈ | 11 ¹ / ₁₆ | | | 7¼ | 20¼ | 5¼ | 4½ | 4¼ | 5½ | ¾ | 1 ³ / ₃₂ | 11 ⁷ / ₁₆ | 7½ | 2 ¹³ / ₁₆ |
| ----- | 375G6-2½ | 7½ | 184JM | 8¾ | 9 ⁷ / ₈ | | | 6¾ | 19½ | 4½ | 5 | 3¾ | 5½ | ½ | 1 ³ / ₃₂ | 11 | 8¼ | 3 ⁵ / ₁₆ |
| ----- | 3100G6-2½ | 10 | 213JM | 10 ³ / ₈ | 11 ¹ / ₁₆ | | | 7¼ | 21 ¹ / ₁₆ | 5¼ | 5 | 4¼ | 5½ | ¾ | 1 ³ / ₃₂ | 12 ⁷ / ₈ | 8¼ | 3 ⁵ / ₁₆ |
| ----- | 3150G6-2½ | 15 | 215JM | 10 ³ / ₈ | 11 ¹ / ₁₆ | 8¾ | 22 ⁷ / ₁₆ | 5¼ | 5 | 4¼ | 7 | ¾ | 1 ³ / ₃₂ | 12 ⁷ / ₈ | 8¼ | 3 ⁵ / ₁₆ | | |
| ----- | 3200G6-2½ | 20 | 254JM | 12 | 11 ⁹ / ₁₆ | 10¼ | 25 ¹⁵ / ₁₆ | 6¼ | 5 | 5 | 8¼ | 7 ⁵ / ₈ | 1 ⁷ / ₃₂ | 13 ⁵ / ₈ | 8¼ | 3 ⁵ / ₁₆ | | |

DIMENSIONS SHOWN ABOVE ARE APPROXIMATE MAXIMUM DIMENSIONS FOR STANDARD PUMPS EQUIPPED WITH ODP MOTORS.

SECTION 2B
PAGE 12
DATE 8/08



PUMPS & SYSTEMS

A Crane Co. Company

USA: (937) 778-8947 • Canada: (905) 457-6223 • International: (937) 615-3598

Close Coupled Centrifugal Pumps



DIMENSIONS IN MILLIMETERS

| MODEL | | HP | MOTOR FRAME SIZE | DISC NPT (in) | SUCT NPT (in) | A | AB | B | CP | D | DD | E | F | G | H | L | X | Y |
|----------------------------|-----------|----|------------------|---------------|---------------|-----|-----|-----|-----|-----|-----|-----|------|-----|-----|-----|-----|-----|
| 1 Phase | 3 Phase | | | | | | | | | | | | | | | | | |
| 1750 & 1450 RPM | | | | | | | | | | | | | | | | | | |
| 104G6-1½ | 3104G6-1½ | 1 | 143JM | 1½ | 2 | 178 | 227 | 127 | 403 | 89 | 105 | 70 | 102 | 9.5 | 8.7 | 240 | 184 | 70 |
| 104G6-2 | 3104G6-2 | 1 | 143JM | 2 | 2½ | 178 | 227 | 127 | 406 | 89 | 114 | 70 | 102 | 9.5 | 8.7 | 243 | 191 | 71 |
| 154G6-2 | 3154G6-2 | 1½ | 145JM | | | 178 | 227 | 152 | 432 | 89 | 114 | 70 | 127 | 9.5 | 8.7 | 243 | 191 | 71 |
| 104G6-2½ | 3104G6-2½ | 1 | 143JM | 2½ | 3 | 178 | 227 | 127 | 424 | 89 | 127 | 70 | 102 | 9.5 | 8.7 | 260 | 210 | 84 |
| 154G6-2½ | 3154G6-2½ | 1½ | 145JM | | | 178 | 227 | 152 | 449 | 89 | 127 | 70 | 127 | 9.5 | 8.7 | 260 | 210 | 84 |
| 204G6-2½ | ----- | 2 | 182JM | | | 222 | 251 | 146 | 470 | 114 | 127 | 95 | 114 | 13 | 10 | 279 | 210 | 84 |
| ----- | 3204G6-2½ | 2 | 145JM | | | 178 | 227 | 152 | 449 | 89 | 127 | 70 | 127 | 9.5 | 8.7 | 260 | 210 | 84 |
| 3500 & 2900 RPM | | | | | | | | | | | | | | | | | | |
| 15G6-1½ | ----- | 1½ | 143JM | 1½ | 2 | 178 | 227 | 127 | 403 | 89 | 105 | 70 | 102 | 9.5 | 8.7 | 240 | 184 | 70 |
| ----- | 315G6-1½ | 1½ | 143JM | | | 178 | 227 | 127 | 403 | 89 | 105 | 70 | 102 | 9.5 | 8.7 | 240 | 184 | 70 |
| 20G6-1½ | ----- | 2 | 145JM | | | 178 | 227 | 152 | 429 | 89 | 105 | 70 | 127 | 9.5 | 8.7 | 240 | 184 | 70 |
| ----- | 320G6-1½ | 2 | 145JM | | | 178 | 227 | 152 | 429 | 89 | 105 | 70 | 127 | 9.5 | 8.7 | 240 | 184 | 70 |
| 30G6-1½ | ----- | 3 | 182JM | | | 222 | 251 | 146 | 449 | 114 | 105 | 95 | 114 | 13 | 10 | 259 | 184 | 70 |
| ----- | 330G6-1½ | 3 | 145JM | | | 178 | 227 | 152 | 429 | 89 | 105 | 70 | 127 | 9.5 | 8.7 | 240 | 184 | 70 |
| 50G6-1½ | ----- | 5 | 184JM | | | 222 | 251 | 172 | 475 | 114 | 105 | 95 | 140 | 13 | 10 | 259 | 184 | 70 |
| ----- | 350G6-1½ | 5 | 182JM | | | 222 | 251 | 146 | 449 | 114 | 105 | 95 | 114 | 13 | 10 | 259 | 184 | 70 |
| ----- | 375G6-1½ | 7½ | 184JM | | | 222 | 251 | 172 | 475 | 114 | 105 | 95 | 140 | 13 | 10 | 259 | 184 | 70 |
| 20G6-2 | ----- | 2 | 145JM | | | 2 | 2½ | 178 | 227 | 152 | 432 | 89 | 114 | 70 | 127 | 9.5 | 8.7 | 243 |
| ----- | 320G6-2 | 2 | 145JM | 178 | 227 | | | 152 | 432 | 89 | 114 | 70 | 127 | 9.5 | 8.7 | 243 | 191 | 71 |
| 30G6-2 | ----- | 3 | 182JM | 222 | 251 | | | 146 | 452 | 114 | 114 | 95 | 114 | 13 | 10 | 262 | 191 | 71 |
| ----- | 330G6-2 | 3 | 145JM | 178 | 227 | | | 152 | 432 | 89 | 114 | 70 | 127 | 9.5 | 8.7 | 243 | 191 | 71 |
| 50G6-2 | ----- | 5 | 184JM | 222 | 251 | | | 172 | 475 | 114 | 114 | 95 | 140 | 13 | 10 | 262 | 191 | 71 |
| ----- | 350G6-2 | 5 | 182JM | 222 | 251 | | | 146 | 452 | 114 | 114 | 95 | 114 | 13 | 10 | 262 | 191 | 71 |
| ----- | 375G6-2 | 7½ | 184JM | 222 | 251 | | | 172 | 475 | 114 | 114 | 95 | 140 | 13 | 10 | 262 | 191 | 71 |
| ----- | 3100G6-2 | 10 | 213JM | 264 | 281 | | | 184 | 514 | 133 | 114 | 108 | 140 | 16 | 10 | 291 | 191 | 71 |
| ----- | 375G6-2½ | 7½ | 184JM | 222 | 251 | | | 172 | 495 | 114 | 127 | 95 | 140 | 13 | 10 | 279 | 210 | 84 |
| ----- | 3100G6-2½ | 10 | 213JM | 264 | 281 | | | 184 | 535 | 133 | 127 | 108 | 140 | 16 | 10 | 308 | 210 | 84 |
| ----- | 3150G6-2½ | 15 | 215JM | 264 | 281 | 222 | 570 | 133 | 127 | 108 | 178 | 16 | 10 | 308 | 210 | 84 | | |
| ----- | 3200G6-2½ | 20 | 254JM | 305 | 294 | 260 | 659 | 159 | 127 | 127 | 210 | 22 | 13.5 | 346 | 210 | 84 | | |

DIMENSIONS SHOWN ABOVE ARE APPROXIMATE MAXIMUM DIMENSIONS FOR STANDARD PUMPS EQUIPPED WITH ODP MOTORS.

Series: 4G7-2, 4G7A-2, 4G7-2½
 G7-2, G7A-2, G7-2½
 Dimensions with Screwed NPT Casing



Close Coupled Centrifugal Pumps



| DIMENSIONS IN INCHES | | | | | | | | | | | | | | | | | | |
|----------------------------|-----------|----|------------------|--------------------------------|---------------------------------|--------------------------------|---------------------------------|-----|----------------------------------|----|----|--------------------------------|---------------------------------|---------------------------------|---------------------------------|---------------------------------|----|----|
| MODEL | | HP | MOTOR FRAME SIZE | DISC NPT (in) | SUCTION NPT (in) | A | AB | B | CP | D | DD | E | F | G | H | L | X | Y |
| 1 Phase | 3 Phase | | | | | | | | | | | | | | | | | |
| 1750 & 1450 RPM | | | | | | | | | | | | | | | | | | |
| 104G7-2 | 3104G7-2 | 1 | 143JM | 2 | 2½ | 7 | 8 ¹⁵ / ₁₆ | 5 | 16 ⁷ / ₈ | 3½ | 5 | 2¾ | 4 | ¾ | 1 ¹¹ / ₃₂ | 10 ⁷ / ₁₆ | 8¼ | 3¾ |
| 154G7-2 | 3154G7-2 | 1½ | 145JM | | | 7 | 8 ¹⁵ / ₁₆ | 6 | 17 ⁷ / ₈ | 3½ | 5 | 2¾ | 5 | ¾ | 1 ¹¹ / ₃₂ | 10 ⁷ / ₁₆ | 8¼ | 3¾ |
| 204G7-2 | ---- | 2 | 182JM | | | 8¾ | 9 ⁷ / ₈ | 5¾ | 18 ¹¹ / ₁₆ | 4½ | 5 | 3¾ | 4½ | ½ | 1 ¹³ / ₃₂ | 11 ³ / ₁₆ | 8¼ | 3¾ |
| ---- | 3204G7-2 | 2 | 145JM | | | 7 | 8 ¹⁵ / ₁₆ | 6 | 17 ⁷ / ₈ | 3½ | 5 | 2¾ | 5 | ¾ | 1 ¹¹ / ₃₂ | 10 ⁷ / ₁₆ | 8¼ | 3¾ |
| 104G7A-2 | 310G7A-2 | 1 | 143JM | 2 | 2½ | 7 | 8 ¹⁵ / ₁₆ | 5 | 16 ⁷ / ₈ | 3½ | 5 | 2¾ | 4 | ¾ | 1 ¹¹ / ₃₂ | 10 ⁷ / ₁₆ | 8¼ | 3¾ |
| 154G7A-2 | 3154G7A-2 | 1½ | 145JM | | | 7 | 8 ¹⁵ / ₁₆ | 6 | 17 ⁷ / ₈ | 3½ | 5 | 2¾ | 5 | ¾ | 1 ¹¹ / ₃₂ | 10 ⁷ / ₁₆ | 8¼ | 3¾ |
| 204G7A-2 | ---- | 2 | 182JM | | | 8¾ | 9 ⁷ / ₈ | 5¾ | 18 ¹¹ / ₁₆ | 4½ | 5 | 3¾ | 4½ | ½ | 1 ¹³ / ₃₂ | 11 ³ / ₁₆ | 8¼ | 3¾ |
| ---- | 3204G7A-2 | 2 | 145JM | | | 7 | 8 ¹⁵ / ₁₆ | 6 | 17 ⁷ / ₈ | 3½ | 5 | 2¾ | 5 | ¾ | 1 ¹¹ / ₃₂ | 10 ⁷ / ₁₆ | 8¼ | 3¾ |
| 154G7-2½ | 3154G7-2½ | 1½ | 145JM | 2½ | 3 | 7 | 8 ¹⁵ / ₁₆ | 6 | 17 ⁷ / ₈ | 3½ | 5½ | 2¾ | 5 | ¾ | 1 ¹¹ / ₃₂ | 10 ⁷ / ₁₆ | 9¼ | 3½ |
| 204G7-2½ | ---- | 2 | 182JM | | | 8¾ | 9 ⁷ / ₈ | 5¾ | 18 ¹¹ / ₁₆ | 4½ | 5½ | 3¾ | 4½ | ½ | 1 ¹³ / ₃₂ | 11 ³ / ₁₆ | 9¼ | 3½ |
| ---- | 3204G7-2½ | 2 | 145JM | | | 7 | 8 ¹⁵ / ₁₆ | 6 | 17 ⁷ / ₈ | 3½ | 5½ | 2¾ | 5 | ¾ | 1 ¹¹ / ₃₂ | 10 ⁷ / ₁₆ | 9¼ | 3½ |
| 304G7-2½ | ---- | 3 | 184JM | | | 8¾ | 9 ⁷ / ₈ | 6¾ | 19 ¹¹ / ₁₆ | 4½ | 5½ | 3¾ | 5½ | ½ | 1 ¹³ / ₃₂ | 11 ³ / ₁₆ | 9¼ | 3½ |
| ---- | 3304G7-2½ | 3 | 182JM | | | 8¾ | 9 ⁷ / ₈ | 5¾ | 18 ¹¹ / ₁₆ | 4½ | 5½ | 3¾ | 4½ | ½ | 1 ¹³ / ₃₂ | 11 ³ / ₁₆ | 9¼ | 3½ |
| 3500 & 2900 RPM | | | | | | | | | | | | | | | | | | |
| 50G7-2 | ---- | 5 | 184JM | 2 | 2½ | 8¾ | 9 ⁷ / ₈ | 6¾ | 19 ¹¹ / ₁₆ | 4½ | 5 | 3¾ | 5½ | ½ | 1 ¹³ / ₃₂ | 11 ³ / ₁₆ | 8¼ | 3¾ |
| ---- | 350G7-2 | 5 | 182JM | | | 8¾ | 9 ⁷ / ₈ | 5¾ | 18 ¹¹ / ₁₆ | 4½ | 5 | 3¾ | 4½ | ½ | 1 ¹³ / ₃₂ | 11 ³ / ₁₆ | 8¼ | 3¾ |
| ---- | 375G7-2 | 7½ | 184JM | | | 8¾ | 9 ⁷ / ₈ | 6¾ | 19 ¹¹ / ₁₆ | 4½ | 5 | 3¾ | 5½ | ½ | 1 ¹³ / ₃₂ | 11 ³ / ₁₆ | 8¼ | 3¾ |
| ---- | 3100G7-2 | 10 | 213JM | | | 10 ³ / ₈ | 11 ¹ / ₁₆ | 7¼ | 21¼ | 5¼ | 5 | 4¼ | 5½ | 5 ⁸ / ₁₆ | 1 ¹³ / ₃₂ | 12 ⁵ / ₁₆ | 8¼ | 3¾ |
| 50G7A-2 | ---- | 5 | 184JM | 2 | 2½ | 8¾ | 9 ⁷ / ₈ | 6¾ | 19 ¹¹ / ₁₆ | 4½ | 5 | 3¾ | 5½ | ½ | 1 ¹³ / ₃₂ | 11 ³ / ₁₆ | 8¼ | 3¾ |
| ---- | 350G7A-2 | 5 | 182JM | | | 8¾ | 9 ⁷ / ₈ | 5¾ | 18 ¹¹ / ₁₆ | 4½ | 5 | 3¾ | 4½ | ½ | 1 ¹³ / ₃₂ | 11 ³ / ₁₆ | 8¼ | 3¾ |
| ---- | 375G7A-2 | 7½ | 184JM | | | 8¾ | 9 ⁷ / ₈ | 6¾ | 19 ¹¹ / ₁₆ | 4½ | 5 | 3¾ | 5½ | ½ | 1 ¹³ / ₃₂ | 11 ³ / ₁₆ | 8¼ | 3¾ |
| ---- | 3100G7A-2 | 10 | 213JM | | | 10 ³ / ₈ | 11 ¹ / ₁₆ | 7¼ | 21¼ | 5¼ | 5 | 4¼ | 5½ | 5 ⁸ / ₁₆ | 1 ¹³ / ₃₂ | 12 ⁵ / ₁₆ | 8¼ | 3¾ |
| ---- | 3150G7A-2 | 15 | 215JM | 10 ³ / ₈ | 11 ¹ / ₁₆ | 8¾ | 22 ⁵ / ₈ | 5¼ | 5 | 4¼ | 7 | 5 ⁸ / ₁₆ | 1 ¹³ / ₃₂ | 12 ⁵ / ₁₆ | 8¼ | 3¾ | | |
| ---- | 3150G7-2½ | 15 | 215JM | 2½ | 3 | 10 ³ / ₈ | 11 ¹ / ₁₆ | 8¾ | 22 ⁵ / ₈ | 5¼ | 5½ | 4¼ | 7 | 5 ⁸ / ₁₆ | 1 ¹³ / ₃₂ | 12 ⁵ / ₁₆ | 9¼ | 3½ |
| ---- | 3200G7-2½ | 20 | 254JM | | | 12 | 11 ¹ / ₁₆ | 10¼ | 26 ³ / ₁₆ | 6¼ | 5½ | 5 | 8¼ | 7 ⁸ / ₁₆ | 1 ¹⁷ / ₃₂ | 13 ⁷ / ₈ | 9¼ | 3½ |
| ---- | 3250G7-2½ | 25 | 256JM | | | 12 | 11 ¹ / ₁₆ | 12 | 27 ¹⁵ / ₁₆ | 6¼ | 5½ | 5 | 10 | 7 ⁸ / ₁₆ | 1 ¹⁷ / ₃₂ | 13 ⁷ / ₈ | 9¼ | 3½ |
| ---- | 3300G7-2½ | 30 | 284JM | | | 13¾ | 13 | 11½ | 27 ¹⁵ / ₁₆ | 7 | 5½ | 5½ | 9½ | 7 ⁸ / ₁₆ | 1 ¹⁷ / ₃₂ | 13 ⁷ / ₈ | 9¼ | 3½ |

DIMENSIONS SHOWN ABOVE ARE APPROXIMATE MAXIMUM DIMENSIONS FOR STANDARD PUMPS EQUIPPED WITH ODP MOTORS.

SECTION 2B
 PAGE 14
 DATE 1/06



PUMPS & SYSTEMS

A Crane Co. Company

USA: (937) 778-8947 • Canada: (905) 457-6223 • International: (937) 615-3598

Close Coupled Centrifugal Pumps

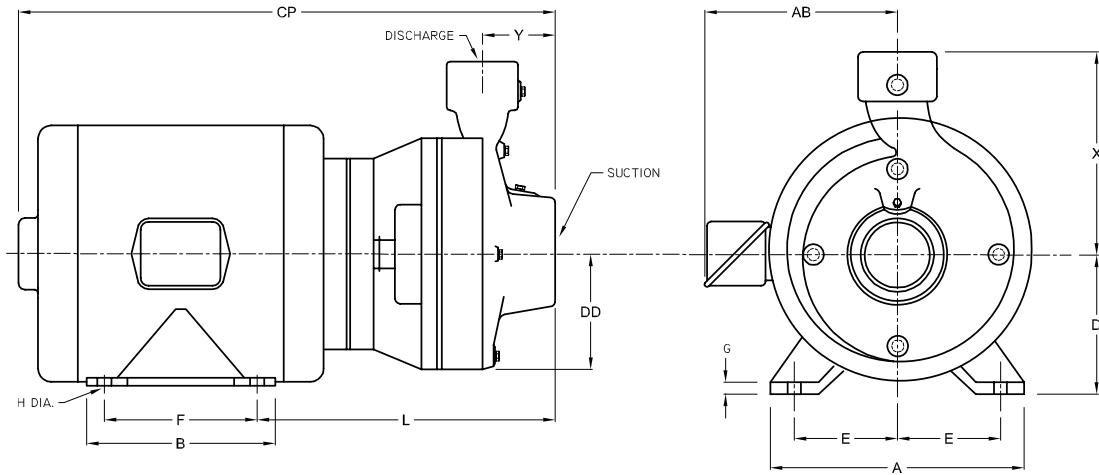

| DIMENSIONS IN MILLIMETERS | | | | | | | | | | | | | | | | | | | | |
|----------------------------|-----------|----|------------------|---------------|---------------|-----|-----|-----|-----|-----|-----|-----|------|-----|------|-----|------|-----|-----|----|
| MODEL | | HP | MOTOR FRAME SIZE | DISC NPT (in) | SUCT NPT (in) | A | AB | B | CP | D | DD | E | F | G | H | L | X | Y | | |
| 1 Phase | 3 Phase | | | | | | | | | | | | | | | | | | | |
| 1750 & 1450 RPM | | | | | | | | | | | | | | | | | | | | |
| 104G7-2 | 3104G7-2 | 1 | 143JM | 2 | 2½ | 178 | 227 | 127 | 429 | 89 | 127 | 70 | 102 | 9.5 | 8.7 | 265 | 210 | 95 | | |
| 154G7-2 | 3154G7-2 | 1½ | 145JM | | | 178 | 227 | 152 | 454 | 89 | 127 | 70 | 127 | 95 | 114 | 13 | 10.3 | 284 | 210 | 95 |
| 204G7-2 | ---- | 2 | 182JM | | | 222 | 251 | 146 | 475 | 114 | 127 | 95 | 114 | 13 | 10.3 | 284 | 210 | 95 | | |
| ---- | 3204G7-2 | 2 | 145JM | | | 178 | 227 | 152 | 454 | 89 | 127 | 70 | 127 | 9.5 | 8.7 | 265 | 210 | 95 | | |
| 104G7A-2 | 310G7A-2 | 1 | 143JM | 2 | 2½ | 178 | 227 | 127 | 429 | 89 | 127 | 70 | 102 | 9.5 | 8.7 | 265 | 210 | 95 | | |
| 154G7A-2 | 3154G7A-2 | 1½ | 145JM | | | 178 | 227 | 152 | 454 | 89 | 127 | 70 | 127 | 9.5 | 8.7 | 265 | 210 | 95 | | |
| 204G7A-2 | ---- | 2 | 182JM | | | 222 | 251 | 146 | 475 | 114 | 127 | 95 | 114 | 13 | 10.3 | 284 | 210 | 95 | | |
| ---- | 3204G7A-2 | 2 | 145JM | | | 178 | 227 | 152 | 454 | 89 | 127 | 70 | 127 | 9.5 | 8.7 | 265 | 210 | 95 | | |
| 154G7-2½ | 3154G7-2½ | 1½ | 145JM | 2½ | 3 | 178 | 227 | 152 | 454 | 89 | 140 | 70 | 127 | 9.5 | 8.7 | 265 | 235 | 89 | | |
| 204G7-2½ | ---- | 2 | 182JM | | | 222 | 251 | 146 | 475 | 114 | 140 | 95 | 114 | 13 | 10.3 | 284 | 235 | 89 | | |
| ---- | 3204G7-2½ | 2 | 145JM | | | 178 | 227 | 152 | 454 | 89 | 140 | 70 | 127 | 9.5 | 8.7 | 265 | 235 | 89 | | |
| 304G7-2½ | ---- | 3 | 184JM | | | 222 | 251 | 172 | 500 | 114 | 140 | 95 | 140 | 13 | 10.3 | 284 | 235 | 89 | | |
| ---- | 3304G7-2½ | 3 | 182JM | | | 222 | 251 | 146 | 475 | 114 | 140 | 95 | 114 | 13 | 10.3 | 284 | 235 | 89 | | |
| 3500 & 2900 RPM | | | | | | | | | | | | | | | | | | | | |
| 50G7-2 | ---- | 5 | 184JM | 2 | 2½ | 222 | 251 | 172 | 500 | 114 | 127 | 95 | 140 | 13 | 10.3 | 284 | 210 | 95 | | |
| ---- | 350G7-2 | 5 | 182JM | | | 222 | 251 | 146 | 475 | 114 | 127 | 95 | 114 | 13 | 10.3 | 284 | 210 | 95 | | |
| ---- | 375G7-2 | 7½ | 184JM | | | 222 | 251 | 172 | 500 | 114 | 127 | 95 | 140 | 13 | 10.3 | 284 | 210 | 95 | | |
| ---- | 3100G7-2 | 10 | 213JM | | | 264 | 281 | 184 | 540 | 133 | 127 | 108 | 140 | 16 | 10.3 | 313 | 210 | 95 | | |
| 50G7A-2 | ---- | 5 | 184JM | 2 | 2½ | 222 | 251 | 172 | 500 | 114 | 127 | 95 | 140 | 13 | 10.3 | 284 | 210 | 95 | | |
| ---- | 350G7A-2 | 5 | 182JM | | | 222 | 251 | 146 | 475 | 114 | 127 | 95 | 114 | 13 | 10.3 | 284 | 210 | 95 | | |
| ---- | 375G7A-2 | 7½ | 184JM | | | 222 | 251 | 172 | 500 | 114 | 127 | 95 | 140 | 13 | 10.3 | 284 | 210 | 95 | | |
| ---- | 3100G7A-2 | 10 | 213JM | | | 264 | 281 | 184 | 540 | 133 | 127 | 108 | 140 | 16 | 10.3 | 313 | 210 | 95 | | |
| ---- | 3150G7A-2 | 15 | 215JM | 264 | 281 | 222 | 575 | 133 | 127 | 108 | 178 | 16 | 10.3 | 313 | 210 | 95 | | | | |
| ---- | 3150G7-2½ | 15 | 215JM | 2½ | 3 | 264 | 281 | 222 | 575 | 133 | 140 | 108 | 178 | 16 | 10.3 | 313 | 235 | 89 | | |
| ---- | 3200G7-2½ | 20 | 254JM | | | 305 | 294 | 260 | 665 | 159 | 140 | 127 | 210 | 22 | 13.5 | 352 | 235 | 89 | | |
| ---- | 3250G7-2½ | 25 | 256JM | | | 305 | 294 | 305 | 710 | 159 | 140 | 127 | 254 | 22 | 13.5 | 352 | 235 | 89 | | |
| ---- | 3300G7-2½ | 30 | 284JM | | | 349 | 330 | 292 | 710 | 178 | 140 | 140 | 241 | 22 | 13.5 | 352 | 235 | 89 | | |

DIMENSIONS SHOWN ABOVE ARE APPROXIMATE MAXIMUM DIMENSIONS FOR STANDARD PUMPS EQUIPPED WITH ODP MOTORS.

Series: 4G9A-1½, 4G9-2, 4G9-2½

G9A-1½, G9-2, G9-2½

Dimensions with Screwed NPT Casing



Close Coupled Centrifugal Pumps

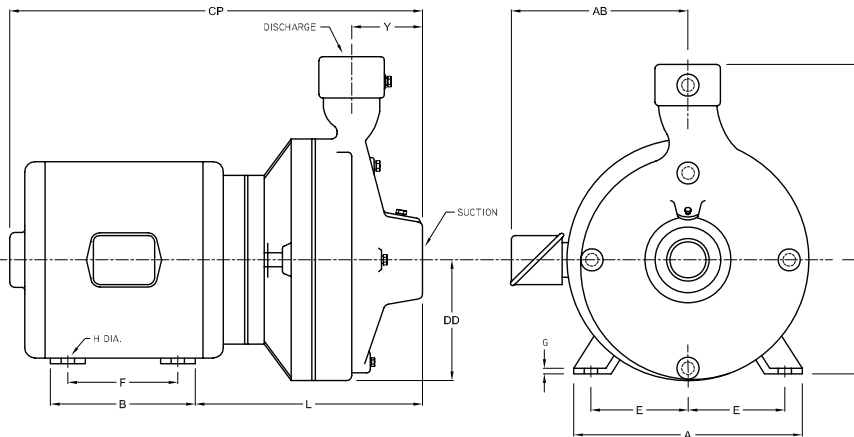

| MODEL | | HP | MOTOR FRAME SIZE | DISC NPT (in) | SUCT NPT (in) | DIMENSIONS IN INCHES | | | | | | | | | | | | | |
|----------------------------|-----------|----|------------------|---------------|-------------------------------|---------------------------------|---------------------------------|-----|----------------------------------|----|---------------------------------|----|--------------------------------|--------------------------------|--------------------------------|--------------------------------|-------------------------------|--------------------------------|--|
| 1 Phase | 3 Phase | | | | | A | AB | B | CP | D | DD | E | F | G | H | L | X | Y | |
| 1750 & 1450 RPM | | | | | | | | | | | | | | | | | | | |
| 154G9-1½ | 3154G9-1½ | 1½ | 145JM | 1½ | 2 | 7 | 8 ¹⁵ / ₁₆ | 6 | 17 ⁹ / ₁₆ | 3½ | 5 ¹³ / ₁₆ | 2¾ | 5 | ¾ | 1 ¹ / ₃₂ | 9¾ | 9 | 3 ¹ / ₁₆ | |
| 204G9-1½ | ---- | 2 | 182JM | | | 8¾ | 9 ⁷ / ₈ | 5¾ | 18 | 4½ | 5 ¹³ / ₁₆ | 3¾ | 4½ | ½ | 1 ³ / ₃₂ | 10½ | 9 | 3 ¹ / ₁₆ | |
| ---- | 3204G9-1½ | 2 | 145JM | | | 7 | 8 ¹⁵ / ₁₆ | 6 | 17 ⁹ / ₁₆ | 3½ | 5 ¹³ / ₁₆ | 2¾ | 5 | ¾ | 1 ¹ / ₃₂ | 9¾ | 9 | 3 ¹ / ₁₆ | |
| 304G9-1½ | ---- | 3 | 184JM | | | 8¾ | 9 ⁷ / ₈ | 6¾ | 19 | 4½ | 5 ¹³ / ₁₆ | 3¾ | 5½ | ½ | 1 ³ / ₃₂ | 10½ | 9 | 3 ¹ / ₁₆ | |
| ---- | 3304G9-1½ | 3 | 182JM | | | 8¾ | 9 ⁷ / ₈ | 5¾ | 18 | 4½ | 5 ¹³ / ₁₆ | 3¾ | 4½ | ½ | 1 ³ / ₃₂ | 10½ | 9 | 3 ¹ / ₁₆ | |
| 154G9-2 | 3154G9-2 | 1½ | 145JM | 2 | 2½ | 7 | 8 ¹⁵ / ₁₆ | 6 | 18 ⁹ / ₁₆ | 3½ | 5 ¹³ / ₁₆ | 2¾ | 5 | ¾ | 1 ¹ / ₃₂ | 10 ⁷ / ₈ | 9 ⁵ / ₈ | 4 | |
| 204G9-2 | ---- | 2 | 182JM | | | 8¾ | 9 ⁷ / ₈ | 5¾ | 19¼ | 4½ | 5 ¹³ / ₁₆ | 3¾ | 4½ | ½ | 1 ³ / ₃₂ | 11 ⁵ / ₈ | 9 ⁵ / ₈ | 4 | |
| ---- | 3204G9-2 | 2 | 145JM | | | 7 | 8 ¹⁵ / ₁₆ | 6 | 18 ⁹ / ₁₆ | 3½ | 5 ¹³ / ₁₆ | 2¾ | 5 | ¾ | 1 ¹ / ₃₂ | 10 ⁷ / ₈ | 9 ⁵ / ₈ | 4 | |
| 304G9-2 | ---- | 3 | 184JM | | | 8¾ | 9 ⁷ / ₈ | 6¾ | 20¼ | 4½ | 5 ¹³ / ₁₆ | 3¾ | 5½ | ½ | 1 ³ / ₃₂ | 11 ⁵ / ₈ | 9 ⁵ / ₈ | 4 | |
| ---- | 3304G9-2 | 3 | 182JM | | | 8¾ | 9 ⁷ / ₈ | 5¾ | 19¼ | 4½ | 5 ¹³ / ₁₆ | 3¾ | 4½ | ½ | 1 ³ / ₃₂ | 11 ⁵ / ₈ | 9 ⁵ / ₈ | 4 | |
| 504G9-2 | 3504G9-2 | 5 | 184JM | 8¾ | 9 ⁷ / ₈ | 6¾ | 20¼ | 4½ | 5 ¹³ / ₁₆ | 3¾ | 5½ | ½ | 1 ³ / ₃₂ | 11 ⁵ / ₈ | 9 ⁵ / ₈ | 4 | | | |
| 304G9-2½ | ---- | 3 | 184JM | 2½ | 3 | 8¾ | 9 ⁷ / ₈ | 6¾ | 19¾ | 4½ | 6 ¹ / ₁₆ | 3¾ | 5½ | ½ | 1 ³ / ₃₂ | 11¼ | 10½ | 3½ | |
| ---- | 3304G9-2½ | 3 | 182JM | | | 8¾ | 9 ⁷ / ₈ | 5¾ | 18¾ | 4½ | 6 ¹ / ₁₆ | 3¾ | 4½ | ½ | 1 ³ / ₃₂ | 11¼ | 10½ | 3½ | |
| 504G9-2½ | 3504G9-2½ | 5 | 184JM | | | 8¾ | 9 ⁷ / ₈ | 6¾ | 19¾ | 4½ | 6 ¹ / ₁₆ | 3¾ | 5½ | ½ | 1 ³ / ₃₂ | 11¼ | 10½ | 3½ | |
| 754G9-2½ | ---- | 7½ | 215JM | | | 10 ⁹ / ₁₆ | 11 ¹ / ₁₆ | 8¾ | 22 ¹¹ / ₁₆ | 5¼ | 6 ¹ / ₁₆ | 4¼ | 7 | ¾ | 1 ³ / ₃₂ | 12 ⁵ / ₈ | 10½ | 3½ | |
| ---- | 3754G9-2½ | 7½ | 213JM | | | 10 ⁹ / ₁₆ | 11 ¹ / ₁₆ | 7¼ | 21 ³ / ₁₆ | 5¼ | 6 ¹ / ₁₆ | 4¼ | 5½ | ¾ | 1 ³ / ₃₂ | 12 ⁵ / ₈ | 10½ | 3½ | |
| 3500 & 2900 RPM | | | | | | | | | | | | | | | | | | | |
| ---- | 350G9-1½ | 5 | 182JM | 1½ | 2 | 8¾ | 9 ⁷ / ₈ | 5¾ | 18 | 4½ | 5 ¹³ / ₁₆ | 3¾ | 4½ | ½ | 1 ³ / ₃₂ | 10½ | 9 | 3 ¹ / ₁₆ | |
| ---- | 375G9-1½ | 7½ | 184JM | | | 8¾ | 9 ⁷ / ₈ | 6¾ | 19 | 4½ | 5 ¹³ / ₁₆ | 3¾ | 5½ | ½ | 1 ³ / ₃₂ | 10½ | 9 | 3 ¹ / ₁₆ | |
| ---- | 3100G9-1½ | 10 | 213JM | | | 10 ⁹ / ₁₆ | 11 ¹ / ₁₆ | 7¼ | 20 ⁷ / ₁₆ | 5¼ | 5 ¹³ / ₁₆ | 4¼ | 5½ | ¾ | 1 ³ / ₃₂ | 11 ⁵ / ₈ | 9 | 3 ¹ / ₁₆ | |
| ---- | 3150G9-1½ | 15 | 215JM | | | 10 ⁹ / ₁₆ | 11 ¹ / ₁₆ | 8¾ | 21 ⁵ / ₁₆ | 5¼ | 5 ¹³ / ₁₆ | 4¼ | 7 | ¾ | 1 ³ / ₃₂ | 11 ⁵ / ₈ | 9 | 3 ¹ / ₁₆ | |
| ---- | 3200G9-1½ | 20 | 254JM | | | 12 | 11 ⁹ / ₁₆ | 10¼ | 25 ³ / ₁₆ | 6¼ | 5 ¹³ / ₁₆ | 5 | 8¼ | 7 ⁸ / ₁₆ | 1 ⁷ / ₃₂ | 13½ | 9 | 3 ¹ / ₁₆ | |
| ---- | 3150G9-2 | 15 | 215JM | 2 | 2½ | 10 ⁹ / ₁₆ | 11 ¹ / ₁₆ | 8¾ | 23 ¹ / ₁₆ | 5¼ | 5 ¹³ / ₁₆ | 4¼ | 7 | ¾ | 1 ³ / ₃₂ | 12¾ | 9 ⁵ / ₈ | 4 | |
| ---- | 3200G9-2 | 20 | 254JM | | | 12 | 11 ⁹ / ₁₆ | 10¼ | 26 ¹⁵ / ₁₆ | 6¼ | 5 ¹³ / ₁₆ | 5 | 8¼ | 7 ⁸ / ₁₆ | 1 ⁷ / ₃₂ | 14 ⁵ / ₈ | 9 ⁵ / ₈ | 4 | |
| ---- | 3250G9-2 | 25 | 256JM | | | 12 | 11 ⁹ / ₁₆ | 12 | 28 ¹¹ / ₁₆ | 6¼ | 5 ¹³ / ₁₆ | 5 | 10 | 7 ⁸ / ₁₆ | 1 ⁷ / ₃₂ | 14 ⁵ / ₈ | 9 ⁵ / ₈ | 4 | |
| ---- | 3300G9-2 | 30 | 284JM | | | 13¾ | 13 | 11½ | 28 ¹¹ / ₁₆ | 7 | 5 ¹³ / ₁₆ | 5½ | 9½ | 7 ⁸ / ₁₆ | 1 ⁷ / ₃₂ | 14 ⁵ / ₈ | 9 ⁵ / ₈ | 4 | |
| ---- | 3400G9-2 | 40 | 286JM | | | 13¾ | 13 | 13 | 30 ³ / ₁₆ | 7 | 5 ¹³ / ₁₆ | 5½ | 11 | 7 ⁸ / ₁₆ | 1 ⁷ / ₃₂ | 14 ⁵ / ₈ | 9 ⁵ / ₈ | 4 | |
| ---- | 3250G9-2½ | 25 | 256JM | 2½ | 3 | 12 | 11 ⁹ / ₁₆ | 12 | 28 ⁵ / ₁₆ | 6¼ | 6 ¹ / ₁₆ | 5 | 10 | 7 ⁸ / ₁₆ | 1 ⁷ / ₃₂ | 14¼ | 10½ | 3½ | |
| ---- | 3300G9-2½ | 30 | 284JM | | | 13¾ | 13 | 11½ | 28 ⁵ / ₁₆ | 7 | 6 ¹ / ₁₆ | 5½ | 9½ | 7 ⁸ / ₁₆ | 1 ⁷ / ₃₂ | 14¼ | 10½ | 3½ | |
| ---- | 3400G9-2½ | 40 | 286JM | | | 13¾ | 13 | 13 | 29 ¹³ / ₁₆ | 7 | 6 ¹ / ₁₆ | 5½ | 11 | 7 ⁸ / ₁₆ | 1 ⁷ / ₃₂ | 14¼ | 10½ | 3½ | |
| ---- | 3500G9-2½ | 50 | 324JM | | | 14½ | 16¼ | 12¼ | 30¾ | 8 | 6 ¹ / ₁₆ | 6¼ | 10½ | 7 ⁸ / ₁₆ | 2 ¹ / ₃₂ | 14¾ | 10½ | 3½ | |
| ---- | 3600G9-2½ | 60 | 326JM | | | 14½ | 16¼ | 13¾ | 31¾ | 8 | 6 ¹ / ₁₆ | 6¼ | 12 | 7 ⁸ / ₁₆ | 2 ¹ / ₃₂ | 14¾ | 10½ | 3½ | |

DIMENSIONS SHOWN ABOVE ARE APPROXIMATE MAXIMUM DIMENSIONS FOR STANDARD PUMPS EQUIPPED WITH ODP MOTORS.

SECTION 2B
PAGE 16
DATE 1/06



PUMPS & SYSTEMS

A Crane Co. Company

USA: (937) 778-8947 • Canada: (905) 457-6223 • International: (937) 615-3598

Close Coupled Centrifugal Pumps

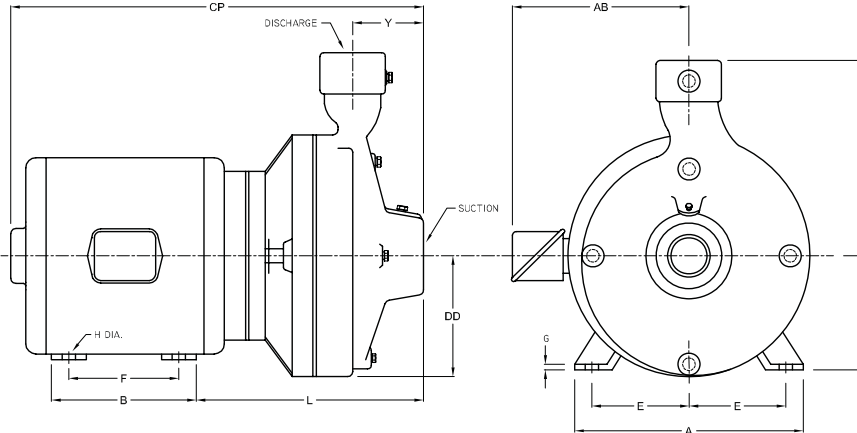

| DIMENSIONS IN MILLIMETERS | | | | | | | | | | | | | | | | | | |
|----------------------------|-----------|----|------------------|---------------|---------------|-----|-----|-----|-----|-----|-----|-----|-----|-----|------|-----|-----|-----|
| MODEL | | HP | MOTOR FRAME SIZE | DISC NPT (in) | SUCT NPT (in) | A | AB | B | CP | D | DD | E | F | G | H | L | X | Y |
| 1 Phase | 3 Phase | | | | | | | | | | | | | | | | | |
| 1750 & 1450 RPM | | | | | | | | | | | | | | | | | | |
| 154G9-1½ | 3154G9-1½ | 1½ | 145JM | 1½ | 2 | 178 | 227 | 152 | 437 | 89 | 148 | 70 | 127 | 9.5 | 8.7 | 248 | 229 | 78 |
| 204G9-1½ | ----- | 2 | 182JM | | | 222 | 251 | 146 | 457 | 114 | 148 | 95 | 114 | 13 | 10.3 | 267 | 229 | 78 |
| ----- | 3204G9-1½ | 2 | 145JM | | | 178 | 227 | 152 | 437 | 89 | 148 | 70 | 127 | 9.5 | 8.7 | 248 | 229 | 78 |
| 304G9-1½ | ----- | 3 | 184JM | | | 222 | 251 | 172 | 483 | 114 | 148 | 95 | 140 | 13 | 10.3 | 267 | 229 | 78 |
| ----- | 3304G9-1½ | 3 | 182JM | | | 222 | 251 | 146 | 457 | 114 | 148 | 95 | 114 | 13 | 10.3 | 267 | 229 | 78 |
| 154G9-2 | 3154G9-2 | 1½ | 145JM | 2 | 2½ | 178 | 227 | 152 | 465 | 89 | 151 | 70 | 127 | 9.5 | 8.7 | 276 | 244 | 102 |
| 204G9-2 | ----- | 2 | 182JM | | | 222 | 251 | 146 | 489 | 114 | 151 | 95 | 114 | 13 | 10.3 | 295 | 244 | 102 |
| ----- | 3204G9-2 | 2 | 145JM | | | 178 | 227 | 152 | 465 | 89 | 151 | 70 | 127 | 9.5 | 8.7 | 276 | 244 | 102 |
| 304G9-2 | ----- | 3 | 184JM | | | 222 | 251 | 172 | 514 | 114 | 151 | 95 | 140 | 13 | 10.3 | 295 | 244 | 102 |
| ----- | 3304G9-2 | 3 | 182JM | | | 222 | 251 | 146 | 489 | 114 | 151 | 95 | 114 | 13 | 10.3 | 295 | 244 | 102 |
| 504G9-2 | 3504G9-2 | 5 | 184JM | | | 222 | 251 | 172 | 514 | 114 | 151 | 95 | 140 | 13 | 10.3 | 295 | 244 | 102 |
| 304G9-2½ | ----- | 3 | 184JM | 2½ | 3 | 222 | 251 | 172 | 502 | 114 | 154 | 95 | 140 | 13 | 10.3 | 286 | 267 | 89 |
| ----- | 3304G9-2½ | 3 | 182JM | | | 222 | 251 | 146 | 476 | 114 | 154 | 95 | 114 | 13 | 10.3 | 286 | 267 | 89 |
| 504G9-2½ | 3504G9-2½ | 5 | 184JM | | | 222 | 251 | 172 | 502 | 114 | 154 | 95 | 140 | 13 | 10.3 | 286 | 267 | 89 |
| 754G9-2½ | ----- | 7½ | 215JM | | | 264 | 281 | 222 | 576 | 133 | 154 | 108 | 178 | 16 | 10.3 | 314 | 267 | 89 |
| ----- | 3754G9-2½ | 7½ | 213JM | | | 264 | 281 | 184 | 538 | 133 | 154 | 108 | 140 | 16 | 10.3 | 314 | 267 | 89 |
| 3500 & 2900 RPM | | | | | | | | | | | | | | | | | | |
| ----- | 350G9-1½ | 5 | 182JM | 1½ | 2 | 222 | 251 | 146 | 457 | 114 | 148 | 95 | 114 | 13 | 10.3 | 267 | 229 | 78 |
| ----- | 375G9-1½ | 7½ | 184JM | | | 222 | 251 | 172 | 483 | 114 | 148 | 95 | 140 | 13 | 10.3 | 267 | 229 | 78 |
| ----- | 3100G9-1½ | 10 | 213JM | | | 264 | 281 | 184 | 519 | 133 | 148 | 108 | 140 | 16 | 10.3 | 295 | 229 | 78 |
| ----- | 3150G9-1½ | 15 | 215JM | | | 264 | 281 | 222 | 557 | 133 | 148 | 108 | 178 | 16 | 10.3 | 295 | 229 | 78 |
| ----- | 3200G9-1½ | 20 | 254JM | | | 305 | 294 | 260 | 656 | 159 | 148 | 127 | 210 | 22 | 13.5 | 343 | 229 | 78 |
| ----- | 3150G9-2 | 15 | 215JM | 2 | 2½ | 264 | 281 | 222 | 586 | 133 | 151 | 108 | 178 | 16 | 10.3 | 324 | 244 | 102 |
| ----- | 3200G9-2 | 20 | 254JM | | | 305 | 294 | 260 | 684 | 159 | 151 | 127 | 210 | 22 | 13.5 | 372 | 244 | 102 |
| ----- | 3250G9-2 | 25 | 256JM | | | 305 | 294 | 305 | 729 | 159 | 151 | 127 | 254 | 22 | 13.5 | 372 | 244 | 102 |
| ----- | 3300G9-2 | 30 | 284JM | | | 349 | 330 | 292 | 729 | 178 | 151 | 140 | 241 | 22 | 13.5 | 372 | 244 | 102 |
| ----- | 3400G9-2 | 40 | 286JM | | | 349 | 330 | 330 | 767 | 178 | 151 | 140 | 279 | 22 | 13.5 | 372 | 244 | 102 |
| ----- | 3250G9-2½ | 25 | 256JM | 2½ | 3 | 305 | 294 | 305 | 719 | 159 | 154 | 127 | 254 | 22 | 13.5 | 362 | 267 | 89 |
| ----- | 3300G9-2½ | 30 | 284JM | | | 349 | 330 | 292 | 719 | 178 | 154 | 140 | 241 | 22 | 13.5 | 362 | 267 | 89 |
| ----- | 3400G9-2½ | 40 | 286JM | | | 349 | 330 | 330 | 757 | 178 | 154 | 140 | 279 | 22 | 13.5 | 362 | 267 | 89 |
| ----- | 3500G9-2½ | 50 | 324JM | | | 368 | 413 | 311 | 768 | 203 | 154 | 159 | 267 | 22 | 16.7 | 375 | 267 | 89 |
| ----- | 3600G9-2½ | 60 | 326JM | | | 368 | 413 | 349 | 806 | 203 | 154 | 159 | 305 | 22 | 16.7 | 375 | 267 | 89 |

DIMENSIONS SHOWN ABOVE ARE APPROXIMATE MAXIMUM DIMENSIONS FOR STANDARD PUMPS EQUIPPED WITH ODP MOTORS.

Series: G6-2F, G6-2½F,
G7-2F, G7A-2F, G7-2½F
Dimensions with Flanged Casing



Close Coupled Centrifugal Pumps



DIMENSIONS IN INCHES

| MODEL | MOTOR FRAME SIZE | DISC NPT (in) | SUCT NPT (in) | A | AB | B | CP | D | DD | E | F | G | H | L | O | X | Y |
|-----------------|----------------------------------|----------------------------------|---------------|----------------------------------|----------------------------------|-----|----------------------------------|--------------------------------|-------------------------------|---------------------------------|----------------------------------|----------------------------------|---------------------------------|----------------------------------|----------------------------------|----|--------------------------------|
| G6-2F | 56 | 2 | 2½ | 5 | --- | 8 | 15 ¹³ / ₁₆ | 5 ⁵ / ₁₆ | 4½ | 1 ¹⁵ / ₁₆ | --- | ¼ | 9 ⁹ / ₁₆ | 7 ⁷ / ₈ | 6 ¹¹ / ₁₆ | 6 | 2½ |
| | 143JM | | | 7 | 8 ¹⁵ / ₁₆ | 5 | 15 ¹⁵ / ₁₆ | 3½ | 4½ | 2¾ | 2 | ¾ | 1 ¹¹ / ₃₂ | 8 ⁸ / ₁₆ | 7 ⁷ / ₁₆ | 6 | 2½ |
| | 145JM | | | 7 | 8 ¹⁵ / ₁₆ | 6 | 16 ¹⁶ / ₁₆ | 3½ | 4½ | 2¾ | 2½ | ¾ | 1 ¹¹ / ₃₂ | 8 ⁸ / ₁₆ | 7 ⁷ / ₁₆ | 6 | 2½ |
| | 182JM | | | 8¾ | 9 ⁹ / ₁₆ | 5¾ | 17 ¹⁷ / ₁₆ | 4½ | 4½ | 3¾ | 2¼ | ½ | 1 ¹³ / ₃₂ | 9 ⁹ / ₁₆ | 9 ⁹ / ₁₆ | 6 | 2½ |
| | 184JM | | | 8¾ | 9 ⁹ / ₁₆ | 6¾ | 18 ¹⁸ / ₁₆ | 4½ | 4½ | 3¾ | 2¾ | ½ | 1 ¹³ / ₃₂ | 9 ⁹ / ₁₆ | 9 ⁹ / ₁₆ | 6 | 2½ |
| | 213JM | | | 10 ¹⁰ / ₁₆ | 11 ¹¹ / ₁₆ | 7¼ | 19 ¹⁹ / ₁₆ | 5¼ | 4½ | 4¼ | 2¾ | 5 ⁵ / ₁₆ | 1 ¹³ / ₃₂ | 10 ¹⁰ / ₁₆ | 11 | 6 | 2½ |
| | 215JM | | | 10 ¹⁰ / ₁₆ | 11 ¹¹ / ₁₆ | 8¾ | 21 ²¹ / ₁₆ | 5¼ | 4½ | 4¼ | 3½ | 5 ⁵ / ₁₆ | 1 ¹³ / ₃₂ | 10 ¹⁰ / ₁₆ | 11 | 6 | 2½ |
| G6-2½F | 143JM | 2½ | 3 | 7 | 8 ¹⁵ / ₁₆ | 5 | 15¾ | 3½ | 5 | 2¾ | 2 | ¾ | 1 ¹¹ / ₃₂ | 9 ⁹ / ₁₆ | 7 ⁷ / ₁₆ | 6½ | 2½ |
| | 145JM | | | 7 | 8 ¹⁵ / ₁₆ | 6 | 16¾ | 3½ | 5 | 2¾ | 2½ | ¾ | 1 ¹¹ / ₃₂ | 9 ⁹ / ₁₆ | 7 ⁷ / ₁₆ | 6½ | 2½ |
| | 182JM | | | 8¾ | 9 ⁹ / ₁₆ | 5¾ | 17 ¹⁷ / ₁₆ | 4½ | 5 | 3¾ | 2¼ | ½ | 1 ¹³ / ₃₂ | 10 ¹⁰ / ₁₆ | 9 ⁹ / ₁₆ | 6½ | 2½ |
| | 184JM | | | 8¾ | 9 ⁹ / ₁₆ | 6¾ | 18 ¹⁸ / ₁₆ | 4½ | 5 | 3¾ | 2¾ | ½ | 1 ¹³ / ₃₂ | 10 ¹⁰ / ₁₆ | 9 ⁹ / ₁₆ | 6½ | 2½ |
| | 213JM | | | 10 ¹⁰ / ₁₆ | 11 ¹¹ / ₁₆ | 7¼ | 20 ²⁰ / ₁₆ | 5¼ | 5 | 4¼ | 2¾ | 5 ⁵ / ₁₆ | 1 ¹³ / ₃₂ | 11 ¹¹ / ₁₆ | 11 | 6½ | 2½ |
| | 215JM | | | 10 ¹⁰ / ₁₆ | 11 ¹¹ / ₁₆ | 8¾ | 21½ | 5¼ | 5 | 4¼ | 3½ | 5 ⁵ / ₁₆ | 1 ¹³ / ₃₂ | 11 ¹¹ / ₁₆ | 11 | 6½ | 2½ |
| | 254JM | | | 12 ¹² / ₁₆ | 11 ¹¹ / ₁₆ | 10¼ | 25 | 6¼ | 5 | 5 | 4½ | 7 ⁷ / ₈ | 1 ¹⁷ / ₃₂ | 12 ¹² / ₁₆ | 13 ¹³ / ₁₆ | 6½ | 2½ |
| 256JM | 12 ¹² / ₁₆ | 11 ¹¹ / ₁₆ | 12¼ | 26¾ | 6¼ | 5 | 5 | 5 | 7 ⁷ / ₈ | 1 ¹⁷ / ₃₂ | 12 ¹² / ₁₆ | 13 ¹³ / ₁₆ | 6½ | 2½ | | | |
| G7-2F G7A-2F | 143JM | 2 | 2½ | 7 | 8 ¹⁵ / ₁₆ | 5 | 15 ¹⁵ / ₁₆ | 3½ | 5 | 2¾ | 2 | ¾ | 1 ¹¹ / ₃₂ | 9 ⁹ / ₁₆ | 7 ⁷ / ₁₆ | 6¾ | 2 ¹ / ₁₆ |
| | 145JM | | | 7 | 8 ¹⁵ / ₁₆ | 6 | 16 ¹⁶ / ₁₆ | 3½ | 5 | 2¾ | 2½ | ¾ | 1 ¹¹ / ₃₂ | 9 ⁹ / ₁₆ | 7 ⁷ / ₁₆ | 6¾ | 2 ¹ / ₁₆ |
| | 182JM | | | 8¾ | 9 ⁹ / ₁₆ | 5¾ | 17 ¹⁷ / ₁₆ | 4½ | 5 | 3¾ | 2¼ | ½ | 1 ¹³ / ₃₂ | 9 ⁹ / ₁₆ | 9 ⁹ / ₁₆ | 6¾ | 2 ¹ / ₁₆ |
| | 184JM | | | 8¾ | 9 ⁹ / ₁₆ | 6¾ | 18 ¹⁸ / ₁₆ | 4½ | 5 | 3¾ | 2¾ | ½ | 1 ¹³ / ₃₂ | 9 ⁹ / ₁₆ | 9 ⁹ / ₁₆ | 6¾ | 2 ¹ / ₁₆ |
| | 213JM | | | 10 ¹⁰ / ₁₆ | 11 ¹¹ / ₁₆ | 7¼ | 19 ¹⁹ / ₁₆ | 5¼ | 5 | 4¼ | 2¾ | 5 ⁵ / ₁₆ | 1 ¹³ / ₃₂ | 11 | 11 | 6¾ | 2 ¹ / ₁₆ |
| | 215JM | | | 10 ¹⁰ / ₁₆ | 11 ¹¹ / ₁₆ | 8¾ | 21 ²¹ / ₁₆ | 5¼ | 5 | 4¼ | 3½ | 5 ⁵ / ₁₆ | 1 ¹³ / ₃₂ | 11 | 11 | 6¾ | 2 ¹ / ₁₆ |
| | 354JM | | | 12 ¹² / ₁₆ | 11 ¹¹ / ₁₆ | 10¼ | 24 ²⁴ / ₁₆ | 6¼ | 5 | 5 | 4½ | 7 ⁷ / ₈ | 1 ¹⁷ / ₃₂ | 12 ¹² / ₁₆ | 13 ¹³ / ₁₆ | 6¾ | 2 ¹ / ₁₆ |
| 256JM | 12 ¹² / ₁₆ | 11 ¹¹ / ₁₆ | 12¼ | 26 ²⁶ / ₁₆ | 6¼ | 5 | 5 | 5 | 7 ⁷ / ₈ | 1 ¹⁷ / ₃₂ | 12 ¹² / ₁₆ | 13 ¹³ / ₁₆ | 6¾ | 2 ¹ / ₁₆ | | | |
| G7-2½F | 143JM | 2½ | 3 | 7 | 8 ¹⁵ / ₁₆ | 5 | 15¾ | 3½ | 5½ | 2¾ | 2 | ¾ | 1 ¹¹ / ₃₂ | 9 ⁹ / ₁₆ | 7 ⁷ / ₁₆ | 7½ | 2½ |
| | 145JM | | | 7 | 8 ¹⁵ / ₁₆ | 6 | 16¾ | 3½ | 5½ | 2¾ | 2½ | ¾ | 1 ¹¹ / ₃₂ | 9 ⁹ / ₁₆ | 7 ⁷ / ₁₆ | 7½ | 2½ |
| | 182JM | | | 8¾ | 9 ⁹ / ₁₆ | 5¾ | 17 ¹⁷ / ₁₆ | 4½ | 5½ | 3¾ | 2¼ | ½ | 1 ¹³ / ₃₂ | 10 ¹⁰ / ₁₆ | 9 ⁹ / ₁₆ | 7½ | 2½ |
| | 184JM | | | 8¾ | 9 ⁹ / ₁₆ | 6¾ | 18 ¹⁸ / ₁₆ | 4½ | 5½ | 3¾ | 2¾ | ½ | 1 ¹³ / ₃₂ | 10 ¹⁰ / ₁₆ | 9 ⁹ / ₁₆ | 7½ | 2½ |
| | 213JM | | | 10 ¹⁰ / ₁₆ | 11 ¹¹ / ₁₆ | 7¼ | 19 ¹⁹ / ₁₆ | 5¼ | 5½ | 4¼ | 2¾ | 5 ⁵ / ₁₆ | 1 ¹³ / ₃₂ | 11 ¹¹ / ₁₆ | 11 | 7½ | 2½ |
| | 215JM | | | 10 ¹⁰ / ₁₆ | 11 ¹¹ / ₁₆ | 8¾ | 21½ | 5¼ | 5½ | 4¼ | 3½ | 5 ⁵ / ₁₆ | 1 ¹³ / ₃₂ | 11 ¹¹ / ₁₆ | 11 | 7½ | 2½ |
| | 254JM | | | 12 ¹² / ₁₆ | 11 ¹¹ / ₁₆ | 10¼ | 25 ²⁵ / ₁₆ | 6¼ | 5½ | 5 | 4½ | 7 ⁷ / ₈ | 1 ¹⁷ / ₃₂ | 12 ¹² / ₁₆ | 13 ¹³ / ₁₆ | 7½ | 2½ |
| | 256JM | | | 12 ¹² / ₁₆ | 11 ¹¹ / ₁₆ | 12¼ | 26 ²⁶ / ₁₆ | 6¼ | 5½ | 5 | 5 | 7 ⁷ / ₈ | 1 ¹⁷ / ₃₂ | 12 ¹² / ₁₆ | 13 ¹³ / ₁₆ | 7½ | 2½ |
| | 284JM | | | 13¾ | 13 | 11½ | 26 ²⁶ / ₁₆ | 7 | 5½ | 5½ | 4¾ | 7 ⁷ / ₈ | 1 ¹⁷ / ₃₂ | 12 ¹² / ₁₆ | 14 ¹⁴ / ₁₆ | 7½ | 2½ |
| | 286JM | | | 13¾ | 13 | 13 | 28 ²⁸ / ₁₆ | 7 | 5½ | 5½ | 5½ | 7 ⁷ / ₈ | 1 ¹⁷ / ₃₂ | 12 ¹² / ₁₆ | 14 ¹⁴ / ₁₆ | 7½ | 2½ |
| | 324JM | | | 14½ | 16¼ | 12¼ | 28¾ | 8 | 5½ | 6¼ | 5¼ | 7 ⁷ / ₈ | 2 ¹ / ₃₂ | 13¼ | 17 ¹⁷ / ₁₆ | 7½ | 2½ |
| 326JM | 14½ | 16¼ | 13¾ | 30¾ | 8 | 5½ | 6¼ | 6 | 7 ⁷ / ₈ | 2 ¹ / ₃₂ | 13¼ | 17 ¹⁷ / ₁₆ | 7½ | 2½ | | | |

DIMENSIONS SHOWN ABOVE ARE APPROXIMATE MAXIMUM DIMENSIONS FOR STANDARD PUMPS EQUIPPED WITH ODP MOTORS.

SECTION 2B
PAGE 18
DATE 1/06



PUMPS & SYSTEMS

A Crane Co. Company

USA: (937) 778-8947 • Canada: (905) 457-6223 • International: (937) 615-3598

Close Coupled Centrifugal Pumps



DIMENSIONS IN MILLIMETERS

| MODEL | MOTOR FRAME SIZE | DISC NPT (in) | SUCT NPT (in) | A | AB | B | CP | D | DD | E | F | G | H | L | O | X | Y |
|-----------------|------------------|---------------|---------------|-----|-----|-----|-----|-----|-----|-----|-----|-----|------|-----|-----|-----|----|
| G6-2F | 56 | 2 | 2½ | 127 | --- | 203 | 402 | 135 | 114 | 49 | --- | 6.4 | 14.3 | 200 | 170 | 152 | 54 |
| | 143JM | | | 178 | 227 | 127 | 389 | 89 | 114 | 70 | 51 | 9.5 | 8.7 | 225 | 183 | 152 | 54 |
| | 145JM | | | 178 | 227 | 152 | 414 | 89 | 114 | 70 | 64 | 9.5 | 8.7 | 225 | 183 | 152 | 54 |
| | 182JM | | | 222 | 251 | 146 | 435 | 114 | 114 | 95 | 57 | 13 | 10.3 | 244 | 246 | 152 | 54 |
| | 184JM | | | 222 | 251 | 172 | 460 | 114 | 114 | 95 | 70 | 13 | 10.3 | 244 | 246 | 152 | 54 |
| | 213JM | | | 264 | 281 | 184 | 500 | 133 | 114 | 108 | 70 | 16 | 10.3 | 273 | 279 | 152 | 54 |
| | 215JM | | | 264 | 281 | 222 | 535 | 133 | 114 | 108 | 89 | 16 | 10.3 | 273 | 279 | 152 | 54 |
| G6-2½F | 143JM | 2½ | 3 | 178 | 227 | 127 | 400 | 89 | 127 | 70 | 51 | 9.5 | 8.7 | 237 | 183 | 165 | 60 |
| | 145JM | | | 178 | 227 | 152 | 425 | 89 | 127 | 70 | 64 | 9.5 | 8.7 | 237 | 183 | 165 | 60 |
| | 182JM | | | 222 | 251 | 146 | 446 | 114 | 127 | 95 | 57 | 13 | 10.3 | 256 | 246 | 165 | 60 |
| | 184JM | | | 222 | 251 | 172 | 472 | 114 | 127 | 95 | 70 | 13 | 10.3 | 256 | 246 | 165 | 60 |
| | 213JM | | | 264 | 281 | 184 | 511 | 133 | 127 | 108 | 70 | 16 | 10.3 | 284 | 279 | 165 | 60 |
| | 215JM | | | 264 | 281 | 222 | 546 | 133 | 127 | 108 | 89 | 16 | 10.3 | 284 | 279 | 165 | 60 |
| | 254JM | | | 314 | 294 | 260 | 635 | 159 | 127 | 127 | 105 | 22 | 13.5 | 322 | 335 | 165 | 60 |
| | 256JM | | | 314 | 294 | 311 | 679 | 159 | 127 | 127 | 127 | 22 | 13.5 | 322 | 335 | 165 | 60 |
| G7-2F G7A-2F | 143JM | 2 | 2½ | 178 | 227 | 127 | 395 | 89 | 127 | 70 | 51 | 9.5 | 8.7 | 232 | 183 | 172 | 62 |
| | 145JM | | | 178 | 227 | 152 | 421 | 89 | 127 | 70 | 64 | 9.5 | 8.7 | 232 | 183 | 172 | 62 |
| | 182JM | | | 222 | 251 | 146 | 441 | 114 | 127 | 95 | 57 | 13 | 10.3 | 251 | 246 | 172 | 62 |
| | 184JM | | | 222 | 251 | 172 | 467 | 114 | 127 | 95 | 70 | 13 | 10.3 | 251 | 246 | 172 | 62 |
| | 213JM | | | 264 | 281 | 184 | 506 | 133 | 127 | 108 | 70 | 16 | 10.3 | 279 | 279 | 172 | 62 |
| | 215JM | | | 264 | 281 | 222 | 541 | 133 | 127 | 108 | 89 | 16 | 10.3 | 279 | 279 | 172 | 62 |
| | 354JM | | | 314 | 294 | 260 | 632 | 159 | 127 | 127 | 105 | 22 | 13.5 | 319 | 335 | 172 | 62 |
| | 256JM | | | 314 | 294 | 311 | 676 | 159 | 127 | 127 | 127 | 22 | 13.5 | 319 | 335 | 172 | 62 |
| G7-2½F | 143JM | 2½ | 3 | 178 | 227 | 127 | 400 | 89 | 140 | 70 | 51 | 9.5 | 8.7 | 237 | 183 | 191 | 60 |
| | 145JM | | | 178 | 227 | 152 | 426 | 89 | 140 | 70 | 64 | 9.5 | 8.7 | 237 | 183 | 191 | 60 |
| | 182JM | | | 222 | 251 | 146 | 446 | 114 | 140 | 95 | 57 | 13 | 10.3 | 256 | 246 | 191 | 60 |
| | 184JM | | | 222 | 251 | 172 | 472 | 114 | 140 | 95 | 70 | 13 | 10.3 | 256 | 246 | 191 | 60 |
| | 213JM | | | 264 | 281 | 184 | 506 | 133 | 140 | 108 | 70 | 16 | 10.3 | 284 | 279 | 191 | 60 |
| | 215JM | | | 264 | 281 | 222 | 546 | 133 | 140 | 108 | 89 | 16 | 10.3 | 284 | 279 | 191 | 60 |
| | 254JM | | | 314 | 294 | 260 | 637 | 159 | 140 | 127 | 105 | 22 | 13.5 | 324 | 335 | 191 | 60 |
| | 256JM | | | 314 | 294 | 311 | 681 | 159 | 140 | 127 | 127 | 22 | 13.5 | 324 | 335 | 191 | 60 |
| | 284JM | | | 349 | 330 | 292 | 681 | 178 | 140 | 140 | 121 | 22 | 13.5 | 324 | 375 | 191 | 60 |
| | 286JM | | | 349 | 330 | 330 | 719 | 178 | 140 | 140 | 140 | 22 | 13.5 | 324 | 375 | 191 | 60 |
| | 324JM | | | 368 | 413 | 311 | 730 | 203 | 140 | 159 | 133 | 22 | 17 | 337 | 435 | 191 | 60 |
| | 326JM | | | 368 | 413 | 349 | 768 | 203 | 140 | 159 | 152 | 22 | 17 | 337 | 435 | 191 | 60 |

DIMENSIONS SHOWN ABOVE ARE APPROXIMATE MAXIMUM DIMENSIONS FOR STANDARD PUMPS EQUIPPED WITH ODP MOTORS.

Close Coupled Centrifugal Pumps



DIMENSIONS IN INCHES

| MODEL | MOTOR FRAME SIZE | DISC NPT (in) | SUCT NPT (in) | A | AB | B | CP | D | DD | E | F | G | H | L | O | X | Y |
|-----------------|------------------|---------------|---------------|---------------------------------|---------------------------------|-----|----------------------------------|----|---------------------------------|----|----|-------------------------------|---------------------------------|----------------------------------|---------------------------------|--------------------------------|---------------------------------|
| G9-2F | 143JM | 2 | 2½ | 7 | 8 ¹⁵ / ₁₆ | 5 | 15 ⁷ / ₈ | 3½ | 5 ¹⁵ / ₁₆ | 2¾ | 2 | ¾ | 1 ¹¹ / ₃₂ | 9 ¹ / ₁₆ | 7 ³ / ₁₆ | 8½ | 2 ⁵ / ₁₆ |
| | 145JM | | | 7 | 8 ¹⁵ / ₁₆ | 6 | 16 ⁷ / ₈ | 3½ | 5 ¹⁵ / ₁₆ | 2¾ | 2½ | ¾ | 1 ¹¹ / ₃₂ | 9 ¹ / ₁₆ | 7 ³ / ₁₆ | 8½ | 2 ⁵ / ₁₆ |
| | 182JM | | | 8¾ | 9 ⁷ / ₈ | 5¾ | 17 ¹³ / ₁₆ | 4½ | 5 ¹⁵ / ₁₆ | 3¾ | 2¼ | ½ | 1 ¹³ / ₃₂ | 10 ³ / ₁₆ | 9 ¹ / ₁₆ | 8½ | 2 ⁵ / ₁₆ |
| | 184JM | | | 8¾ | 9 ⁷ / ₈ | 6¾ | 18 ¹³ / ₁₆ | 4½ | 5 ¹⁵ / ₁₆ | 3¾ | 2¾ | ½ | 1 ¹³ / ₃₂ | 10 ³ / ₁₆ | 9 ¹ / ₁₆ | 8½ | 2 ⁵ / ₁₆ |
| | 213JM | | | 10 ⁹ / ₁₆ | 11 ¹ / ₁₆ | 7¼ | 20 ⁹ / ₁₆ | 5¼ | 5 ¹⁵ / ₁₆ | 4¼ | 2¾ | 5 ⁵ / ₈ | 1 ¹³ / ₃₂ | 11 ⁵ / ₁₆ | 11 | 8½ | 2 ⁵ / ₁₆ |
| | 215JM | | | 10 ⁹ / ₁₆ | 11 ¹ / ₁₆ | 8¾ | 21 ⁵ / ₈ | 5¼ | 5 ¹⁵ / ₁₆ | 4¼ | 3½ | 5 ⁵ / ₈ | 1 ¹³ / ₃₂ | 11 ⁵ / ₁₆ | 11 | 8½ | 2 ⁵ / ₁₆ |
| | 254JM | | | 12 ³ / ₈ | 11 ⁹ / ₁₆ | 10¼ | 25½ | 6¼ | 5 ¹⁵ / ₁₆ | 5 | 4½ | 7 ⁵ / ₈ | 1 ¹⁷ / ₃₂ | 13 ³ / ₁₆ | 13 ³ / ₁₆ | 8½ | 2 ⁵ / ₁₆ |
| | 256JM | | | 12 ³ / ₈ | 11 ⁹ / ₁₆ | 12¼ | 27¼ | 6¼ | 5 ¹⁵ / ₁₆ | 5 | 5 | 7 ⁵ / ₈ | 1 ¹⁷ / ₃₂ | 13 ³ / ₁₆ | 13 ³ / ₁₆ | 8½ | 2 ⁵ / ₁₆ |
| | 284JM | | | 13¾ | 13 | 11½ | 27¼ | 7 | 5 ¹⁵ / ₁₆ | 5½ | 4¾ | 7 ⁵ / ₈ | 1 ¹⁷ / ₃₂ | 13 ³ / ₁₆ | 14¾ | 8½ | 2 ⁵ / ₁₆ |
| | 286JM | | | 13¾ | 13 | 13 | 28¾ | 7 | 5 ¹⁵ / ₁₆ | 5½ | 5½ | 7 ⁵ / ₈ | 1 ¹⁷ / ₃₂ | 13 ³ / ₁₆ | 14¾ | 8½ | 2 ⁵ / ₁₆ |
| | 324JM | | | 14½ | 16¼ | 12¼ | 29 ⁹ / ₁₆ | 8 | 5 ¹⁵ / ₁₆ | 6¼ | 5¼ | 7 ⁵ / ₈ | 2 ¹ / ₃₂ | 13 ¹¹ / ₁₆ | 17 ¹ / ₈ | 8½ | 2 ⁵ / ₁₆ |
| | 326JM | | | 14½ | 16¼ | 13¾ | 30 ¹¹ / ₁₆ | 8 | 5 ¹⁵ / ₁₆ | 6¼ | 6 | 7 ⁵ / ₈ | 2 ¹ / ₃₂ | 13 ¹¹ / ₁₆ | 17 ¹ / ₈ | 8½ | 2 ⁵ / ₁₆ |
| G9-2½F | 143JM | 2½ | 3 | 7 | 8 ¹⁵ / ₁₆ | 5 | 16 ¹ / ₁₆ | 3½ | 6 ¹ / ₁₆ | 2¾ | 2 | ¾ | 1 ¹¹ / ₃₂ | 9 ⁵ / ₁₆ | 7 ³ / ₁₆ | 9¼ | 2 ⁵ / ₁₆ |
| | 145JM | | | 7 | 8 ¹⁵ / ₁₆ | 6 | 17 ¹ / ₁₆ | 3½ | 6 ¹ / ₁₆ | 2¾ | 2½ | ¾ | 1 ¹¹ / ₃₂ | 9 ⁵ / ₁₆ | 7 ³ / ₁₆ | 9¼ | 2 ⁵ / ₁₆ |
| | 182JM | | | 8¾ | 9 ⁷ / ₈ | 5¾ | 17 ⁷ / ₈ | 4½ | 6 ¹ / ₁₆ | 3¾ | 2¼ | ½ | 1 ¹³ / ₃₂ | 10 ³ / ₁₆ | 9 ¹ / ₁₆ | 9¼ | 2 ⁵ / ₁₆ |
| | 184JM | | | 8¾ | 9 ⁷ / ₈ | 6¾ | 18 ⁷ / ₈ | 4½ | 6 ¹ / ₁₆ | 3¾ | 2¾ | ½ | 1 ¹³ / ₃₂ | 10 ³ / ₁₆ | 9 ¹ / ₁₆ | 9¼ | 2 ⁵ / ₁₆ |
| | 213JM | | | 10 ⁹ / ₁₆ | 11 ¹ / ₁₆ | 7¼ | 20 ⁹ / ₁₆ | 5¼ | 6 ¹ / ₁₆ | 4¼ | 2¾ | 5 ⁵ / ₈ | 1 ¹³ / ₃₂ | 11½ | 11 | 9¼ | 2 ⁵ / ₁₆ |
| | 215JM | | | 10 ⁹ / ₁₆ | 11 ¹ / ₁₆ | 8¾ | 21 ³ / ₁₆ | 5¼ | 6 ¹ / ₁₆ | 4¼ | 3½ | 5 ⁵ / ₈ | 1 ¹³ / ₃₂ | 11½ | 11 | 9¼ | 2 ⁵ / ₁₆ |
| | 254JM | | | 12 ³ / ₈ | 11 ⁹ / ₁₆ | 10¼ | 25 ¹¹ / ₁₆ | 6¼ | 6 ¹ / ₁₆ | 5 | 4½ | 7 ⁵ / ₈ | 1 ¹⁷ / ₃₂ | 13 ³ / ₁₆ | 13 ³ / ₁₆ | 9¼ | 2 ⁵ / ₁₆ |
| | 256JM | | | 12 ³ / ₈ | 11 ⁹ / ₁₆ | 12¼ | 27 ⁷ / ₁₆ | 6¼ | 6 ¹ / ₁₆ | 5 | 5 | 7 ⁵ / ₈ | 1 ¹⁷ / ₃₂ | 13 ³ / ₁₆ | 13 ³ / ₁₆ | 9¼ | 2 ⁵ / ₁₆ |
| | 284JM | | | 13¾ | 13 | 11½ | 27 ¹ / ₁₆ | 7 | 6 ¹ / ₁₆ | 5½ | 4¾ | 7 ⁵ / ₈ | 1 ¹⁷ / ₃₂ | 13 ³ / ₁₆ | 14¾ | 9¼ | 2 ⁵ / ₁₆ |
| | 286JM | | | 13¾ | 13 | 13 | 28 ⁵ / ₁₆ | 7 | 6 ¹ / ₁₆ | 5½ | 5½ | 7 ⁵ / ₈ | 1 ¹⁷ / ₃₂ | 13 ³ / ₁₆ | 14¾ | 9¼ | 2 ⁵ / ₁₆ |
| | 324JM | | | 14½ | 16¼ | 12¼ | 29 ⁹ / ₁₆ | 8 | 6 ¹ / ₁₆ | 6¼ | 5¼ | 7 ⁵ / ₈ | 2 ¹ / ₃₂ | 13 ⁷ / ₁₆ | 17 ¹ / ₈ | 9¼ | 2 ⁵ / ₁₆ |
| | 326JM | | | 14½ | 16¼ | 13¾ | 30 ⁷ / ₁₆ | 8 | 6 ¹ / ₁₆ | 6¼ | 6 | 7 ⁵ / ₈ | 2 ¹ / ₃₂ | 13 ⁷ / ₁₆ | 17 ¹ / ₈ | 9¼ | 2 ⁵ / ₁₆ |
| G9-3F G9A-3F | 182JM | 3 | 4 | 8¾ | 9 ⁷ / ₈ | 5¾ | 18 ⁷ / ₁₆ | 4½ | 6¼ | 3¾ | 2¼ | ½ | 1 ¹³ / ₃₂ | 11 | 9 ¹ / ₁₆ | 9 | 2 ¹¹ / ₁₆ |
| | 184JM | | | 8¾ | 9 ⁷ / ₈ | 6¾ | 19 ⁷ / ₁₆ | 4½ | 6¼ | 3¾ | 2¾ | ½ | 1 ¹³ / ₃₂ | 11 | 9 ¹ / ₁₆ | 9 | 2 ¹¹ / ₁₆ |
| | 213JM | | | 10 ⁹ / ₁₆ | 11 ¹ / ₁₆ | 7¼ | 20 ³ / ₄ | 5¼ | 6¼ | 4¼ | 2¾ | 5 ⁵ / ₈ | 1 ¹³ / ₃₂ | 11 ⁷ / ₈ | 11 | 9 | 2 ¹¹ / ₁₆ |
| | 215JM | | | 10 ⁹ / ₁₆ | 11 ¹ / ₁₆ | 8¾ | 22¼ | 5¼ | 6¼ | 4¼ | 3½ | 5 ⁵ / ₈ | 1 ¹³ / ₃₂ | 11 ⁷ / ₈ | 11 | 9 | 2 ¹¹ / ₁₆ |
| | 284JM | | | 13¾ | 13 | 11½ | 27 ⁷ / ₈ | 7 | 6¼ | 5½ | 4¾ | 7 ⁵ / ₈ | 1 ¹⁷ / ₃₂ | 13 ³ / ₁₆ | 14¾ | 9 | 2 ¹¹ / ₁₆ |
| | 286JM | | | 13¾ | 13 | 13 | 29 ⁹ / ₈ | 7 | 6¼ | 5½ | 5½ | 7 ⁵ / ₈ | 1 ¹⁷ / ₃₂ | 13 ³ / ₁₆ | 14¾ | 9 | 2 ¹¹ / ₁₆ |
| | 324JM | | | 14½ | 16¼ | 12¼ | 29 ¹³ / ₁₆ | 8 | 6¼ | 6¼ | 5¼ | 7 ⁵ / ₈ | 2 ¹ / ₃₂ | 14 ⁷ / ₁₆ | 17 ¹ / ₈ | 9 | 2 ¹¹ / ₁₆ |
| | 326JM | | | 14½ | 16¼ | 13¾ | 31 ⁵ / ₁₆ | 8 | 6¼ | 6¼ | 6 | 7 ⁵ / ₈ | 2 ¹ / ₃₂ | 14 ⁷ / ₁₆ | 17 ¹ / ₈ | 9 | 2 ¹¹ / ₁₆ |
| 4G9-4F | 182JM | 4 | 5 | 8¾ | 9 ¹¹ / ₁₆ | 5¾ | 19½ | 4½ | 7 ⁷ / ₁₆ | 3¾ | 2¼ | ½ | 1 ¹³ / ₃₂ | 11¾ | 9 ¹ / ₁₆ | 10 ⁵ / ₈ | 3¼ |
| | 184JM | | | 8¾ | 9 ¹¹ / ₁₆ | 6¾ | 21½ | 4½ | 7 ⁷ / ₁₆ | 3¾ | 2¾ | ½ | 1 ¹³ / ₃₂ | 11¾ | 9 ¹ / ₁₆ | 10 ⁵ / ₈ | 3¼ |
| | 213JM | | | 10 ⁹ / ₁₆ | 10 ⁷ / ₈ | 7¾ | 21 ⁵ / ₁₆ | 5¼ | 7 ⁷ / ₁₆ | 4¼ | 2¾ | 5 ⁵ / ₈ | 1 ¹³ / ₃₂ | 12 ³ / ₈ | 11 | 10 ⁵ / ₈ | 3¼ |
| | 215JM | | | 10 ⁹ / ₁₆ | 10 ⁷ / ₈ | 8¾ | 23 ⁷ / ₁₆ | 5¼ | 7 ⁷ / ₁₆ | 4¼ | 3½ | 5 ⁵ / ₈ | 1 ¹³ / ₃₂ | 12 ³ / ₈ | 11 | 10 ⁵ / ₈ | 3¼ |

DIMENSIONS SHOWN ABOVE ARE APPROXIMATE MAXIMUM DIMENSIONS FOR STANDARD PUMPS EQUIPPED WITH ODP MOTORS.

Close Coupled Centrifugal Pumps



DIMENSIONS IN MILLIMETERS

| MODEL | MOTOR FRAME SIZE | DISC NPT (in) | SUCT NPT (in) | A | AB | B | CP | D | DD | E | F | G | H | L | O | X | Y |
|-----------------|------------------|---------------|---------------|-----|-----|-----|-----|-----|-----|-----|-----|-----|------|-----|-----|-----|----|
| G9-2F | 143JM | 2 | 2½ | 178 | 227 | 127 | 403 | 89 | 151 | 70 | 51 | 9.5 | 8.7 | 240 | 183 | 216 | 65 |
| | 145JM | | | 178 | 227 | 152 | 429 | 89 | 151 | 70 | 64 | 9.5 | 8.7 | 240 | 183 | 216 | 65 |
| | 182JM | | | 222 | 251 | 146 | 452 | 114 | 151 | 95 | 57 | 13 | 10.3 | 259 | 246 | 216 | 65 |
| | 184JM | | | 222 | 251 | 172 | 478 | 114 | 151 | 95 | 70 | 13 | 10.3 | 259 | 246 | 216 | 65 |
| | 213JM | | | 264 | 281 | 184 | 511 | 133 | 151 | 108 | 70 | 16 | 10.3 | 287 | 279 | 216 | 65 |
| | 215JM | | | 264 | 281 | 222 | 549 | 133 | 151 | 108 | 89 | 16 | 10.3 | 287 | 279 | 216 | 65 |
| | 254JM | | | 314 | 294 | 260 | 648 | 159 | 151 | 127 | 105 | 22 | 13.5 | 335 | 335 | 216 | 65 |
| | 256JM | | | 314 | 294 | 311 | 692 | 159 | 151 | 127 | 127 | 22 | 13.5 | 335 | 335 | 216 | 65 |
| | 284JM | | | 349 | 330 | 292 | 692 | 178 | 151 | 140 | 121 | 22 | 13.5 | 335 | 375 | 216 | 65 |
| | 286JM | | | 349 | 330 | 330 | 730 | 178 | 151 | 140 | 140 | 22 | 13.5 | 335 | 375 | 216 | 65 |
| | 324JM | | | 368 | 413 | 311 | 741 | 203 | 151 | 159 | 133 | 22 | 17 | 348 | 435 | 216 | 65 |
| | 326JM | | | 368 | 413 | 349 | 779 | 203 | 151 | 159 | 152 | 22 | 17 | 348 | 435 | 216 | 65 |
| G9-2½F | 143JM | 2½ | 3 | 178 | 227 | 127 | 408 | 89 | 154 | 70 | 51 | 9.5 | 8.7 | 245 | 183 | 235 | 65 |
| | 145JM | | | 178 | 227 | 152 | 433 | 89 | 154 | 70 | 64 | 9.5 | 8.7 | 245 | 183 | 235 | 65 |
| | 182JM | | | 222 | 251 | 146 | 454 | 114 | 154 | 95 | 57 | 13 | 10.3 | 264 | 246 | 235 | 65 |
| | 184JM | | | 222 | 251 | 172 | 479 | 114 | 154 | 95 | 70 | 13 | 10.3 | 264 | 246 | 235 | 65 |
| | 213JM | | | 264 | 281 | 184 | 516 | 133 | 154 | 108 | 70 | 16 | 10.3 | 292 | 279 | 235 | 65 |
| | 215JM | | | 264 | 281 | 222 | 554 | 133 | 154 | 108 | 89 | 16 | 10.3 | 292 | 279 | 235 | 65 |
| | 254JM | | | 314 | 294 | 260 | 653 | 159 | 154 | 127 | 105 | 22 | 13.5 | 340 | 335 | 235 | 65 |
| | 256JM | | | 314 | 294 | 311 | 697 | 159 | 154 | 127 | 127 | 22 | 13.5 | 340 | 335 | 235 | 65 |
| | 284JM | | | 349 | 330 | 292 | 697 | 178 | 154 | 140 | 121 | 22 | 13.5 | 340 | 375 | 235 | 65 |
| | 286JM | | | 349 | 330 | 330 | 735 | 178 | 154 | 140 | 140 | 22 | 13.5 | 340 | 375 | 235 | 65 |
| | 324JM | | | 368 | 413 | 311 | 746 | 203 | 154 | 159 | 133 | 22 | 17 | 352 | 435 | 235 | 65 |
| | 326JM | | | 368 | 413 | 349 | 784 | 203 | 154 | 159 | 152 | 22 | 17 | 352 | 435 | 235 | 65 |
| G9-3F G9A-3F | 182JM | 3 | 4 | 222 | 251 | 146 | 468 | 114 | 159 | 95 | 57 | 13 | 10.3 | 279 | 246 | 229 | 68 |
| | 184JM | | | 222 | 251 | 172 | 494 | 114 | 159 | 95 | 70 | 13 | 10.3 | 279 | 246 | 229 | 68 |
| | 213JM | | | 264 | 281 | 184 | 527 | 133 | 159 | 108 | 70 | 16 | 10.3 | 302 | 279 | 229 | 68 |
| | 215JM | | | 264 | 281 | 222 | 565 | 133 | 159 | 108 | 89 | 16 | 10.3 | 302 | 279 | 229 | 68 |
| | 284JM | | | 349 | 330 | 292 | 708 | 178 | 159 | 140 | 121 | 22 | 13.5 | 351 | 375 | 229 | 68 |
| | 286JM | | | 349 | 330 | 330 | 746 | 178 | 159 | 140 | 140 | 22 | 13.5 | 351 | 375 | 229 | 68 |
| | 324JM | | | 368 | 413 | 311 | 757 | 203 | 159 | 159 | 133 | 22 | 17 | 364 | 435 | 229 | 68 |
| | 326JM | | | 368 | 413 | 349 | 795 | 203 | 159 | 159 | 152 | 22 | 17 | 364 | 435 | 229 | 68 |
| 4G9-4F | 182JM | 4 | 5 | 222 | 246 | 146 | 495 | 114 | 192 | 95 | 57 | 13 | 10.3 | 299 | 246 | 270 | 83 |
| | 184JM | | | 222 | 246 | 172 | 546 | 114 | 192 | 95 | 70 | 13 | 10.3 | 299 | 246 | 270 | 83 |
| | 213JM | | | 264 | 276 | 197 | 557 | 133 | 192 | 108 | 70 | 16 | 10.3 | 321 | 279 | 270 | 83 |
| | 215JM | | | 264 | 276 | 222 | 595 | 133 | 192 | 108 | 89 | 16 | 10.3 | 321 | 279 | 270 | 83 |

DIMENSIONS SHOWN ABOVE ARE APPROXIMATE MAXIMUM DIMENSIONS FOR STANDARD PUMPS EQUIPPED WITH ODP MOTORS.

Close Coupled Centrifugal Pumps

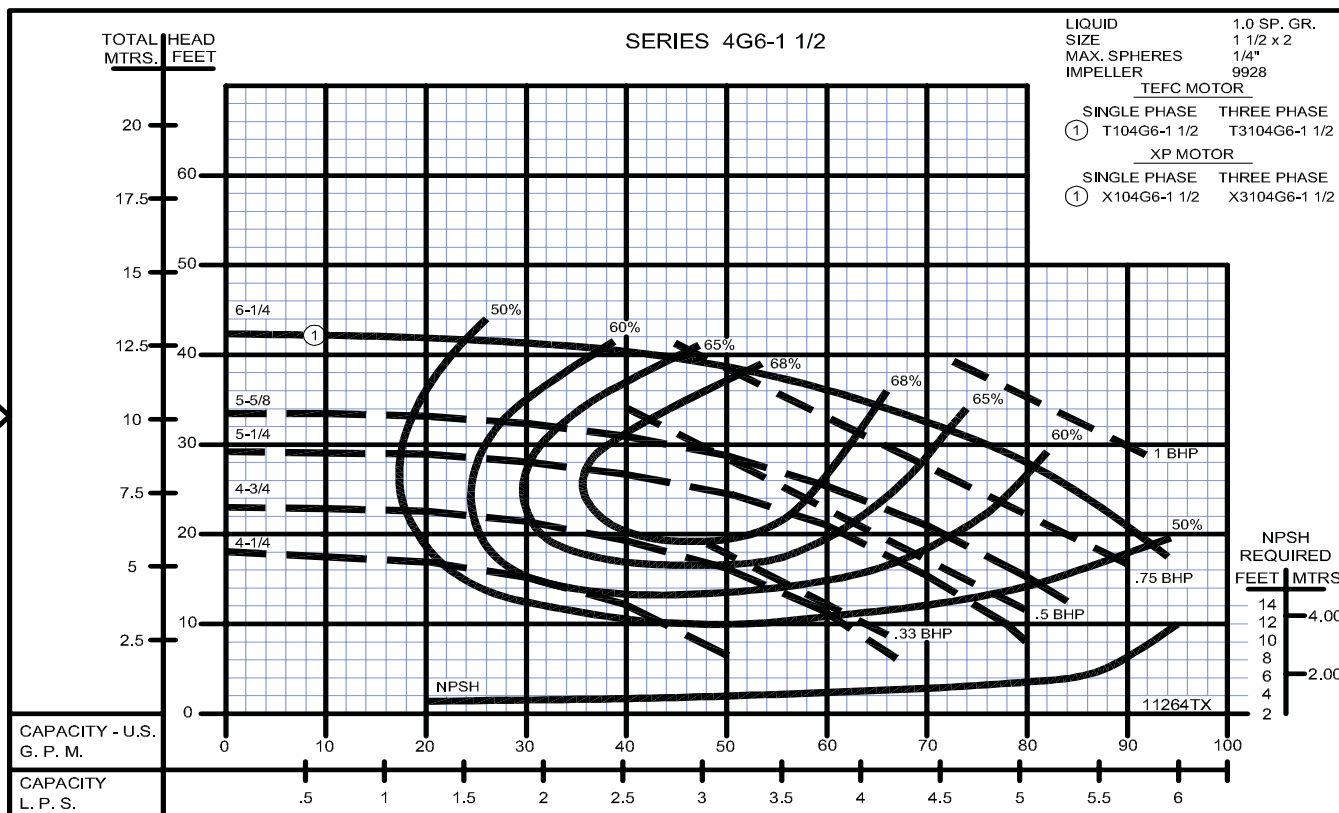
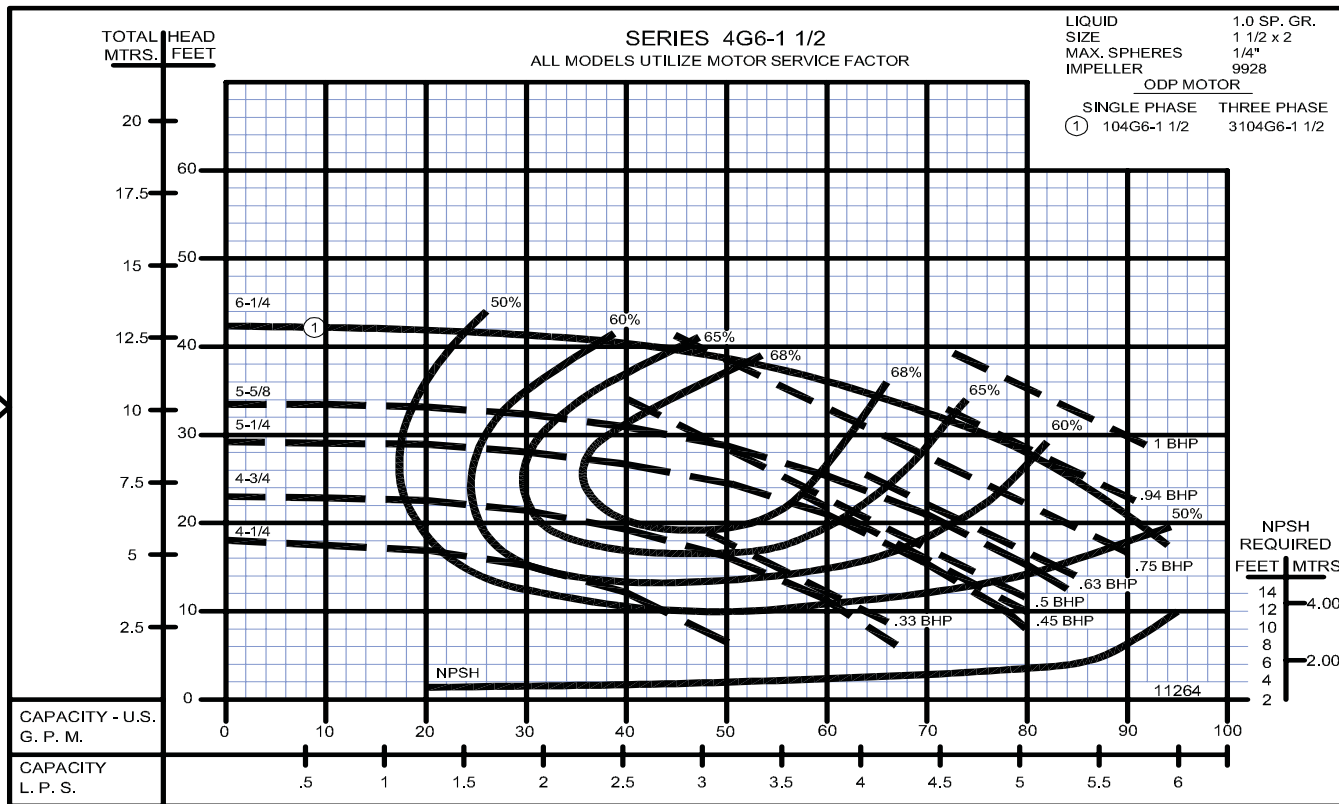

SECTION 2B
PAGE 22
DATE 1/06



PUMPS & SYSTEMS

A Crane Co. Company

USA: (937) 778-8947 • Canada: (905) 457-6223 • International: (937) 615-3598

Close Coupled Centrifugal Pumps

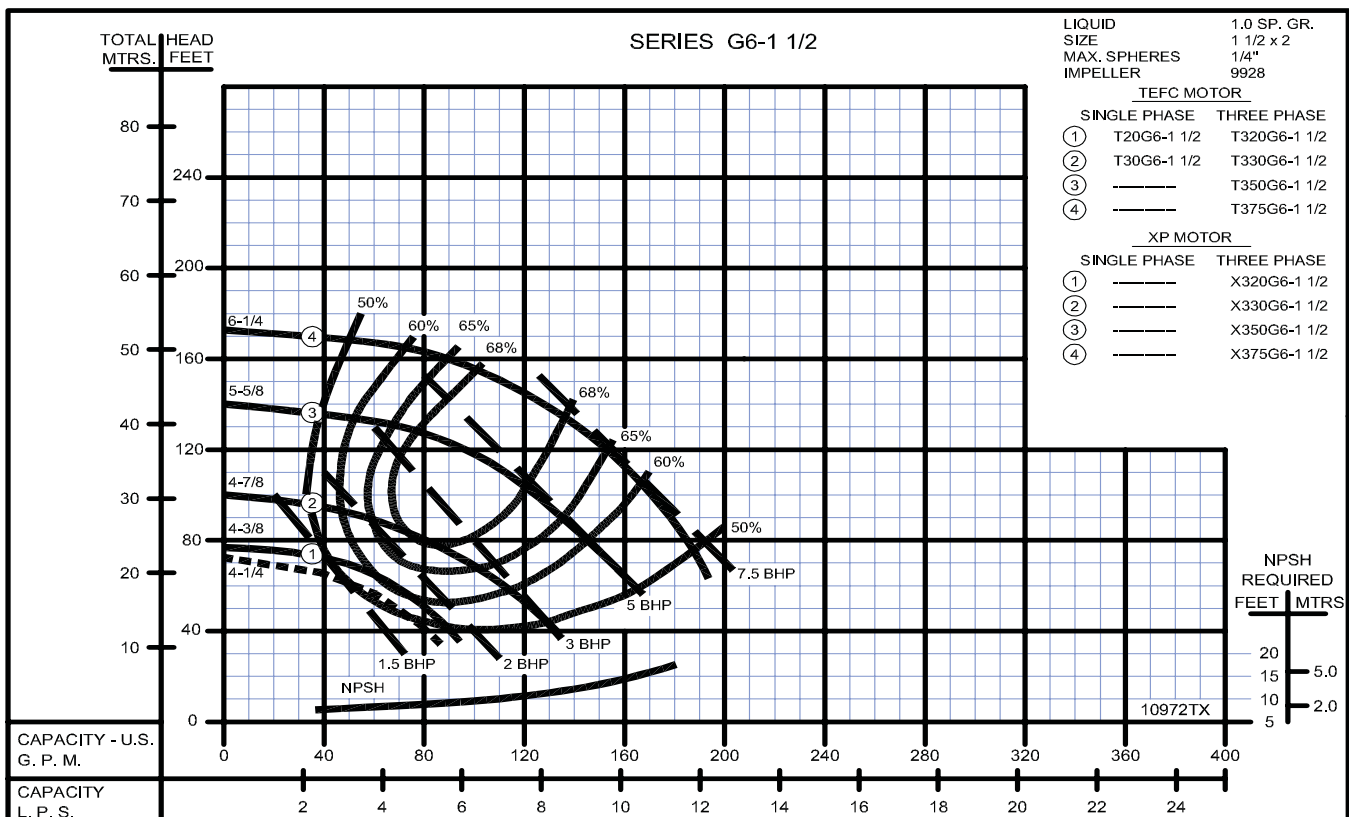

Close Coupled Centrifugal Pumps



Close Coupled Centrifugal Pumps

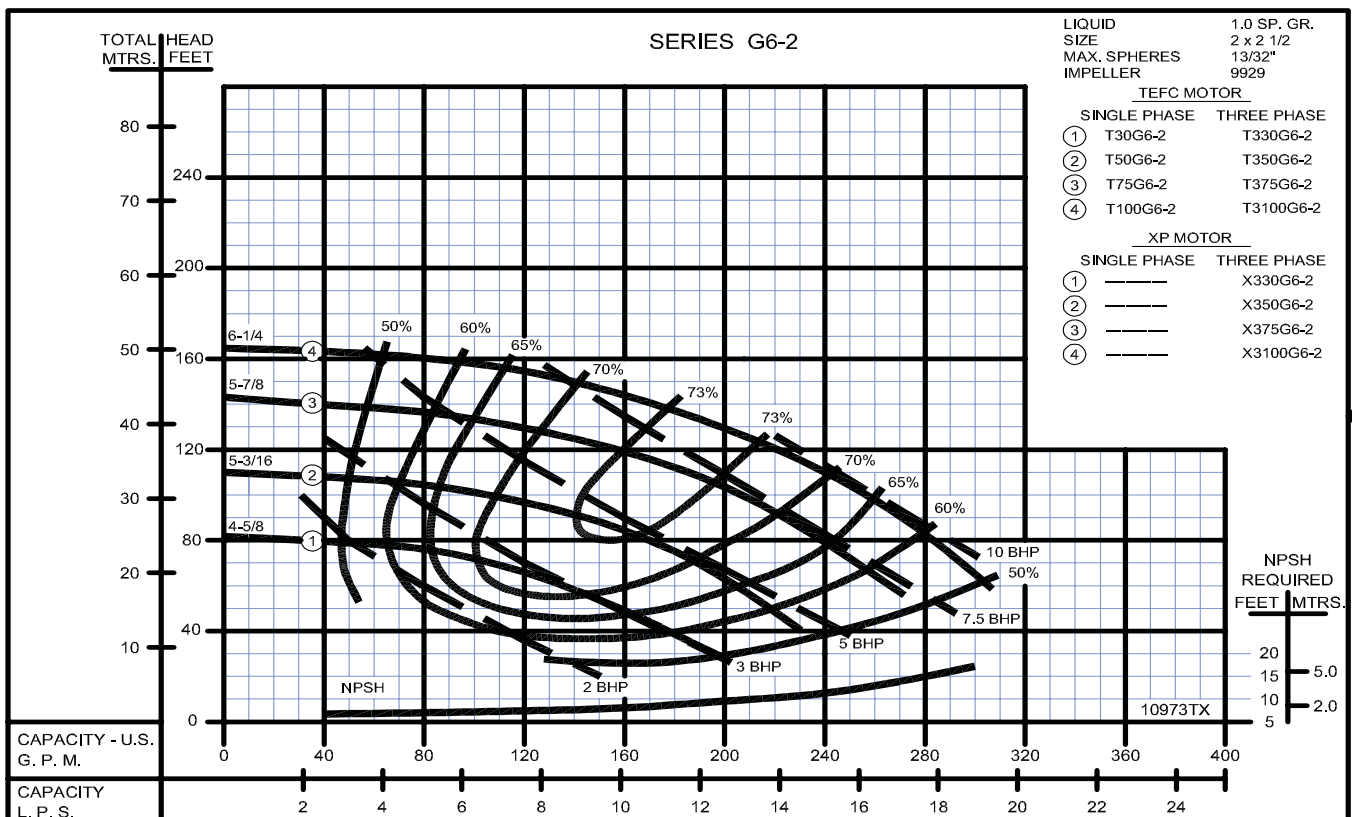

Close Coupled Centrifugal Pumps



Close Coupled Centrifugal Pumps

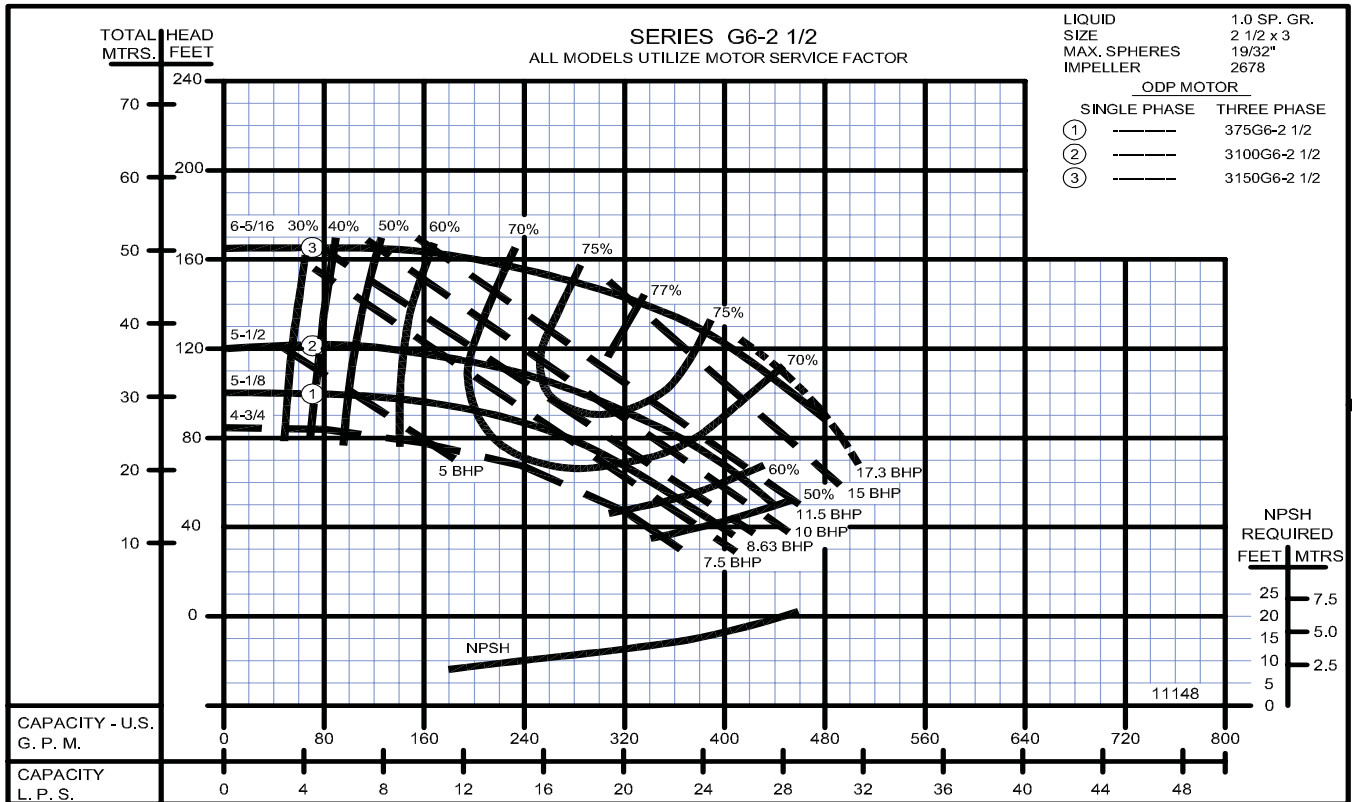

3500 RPM

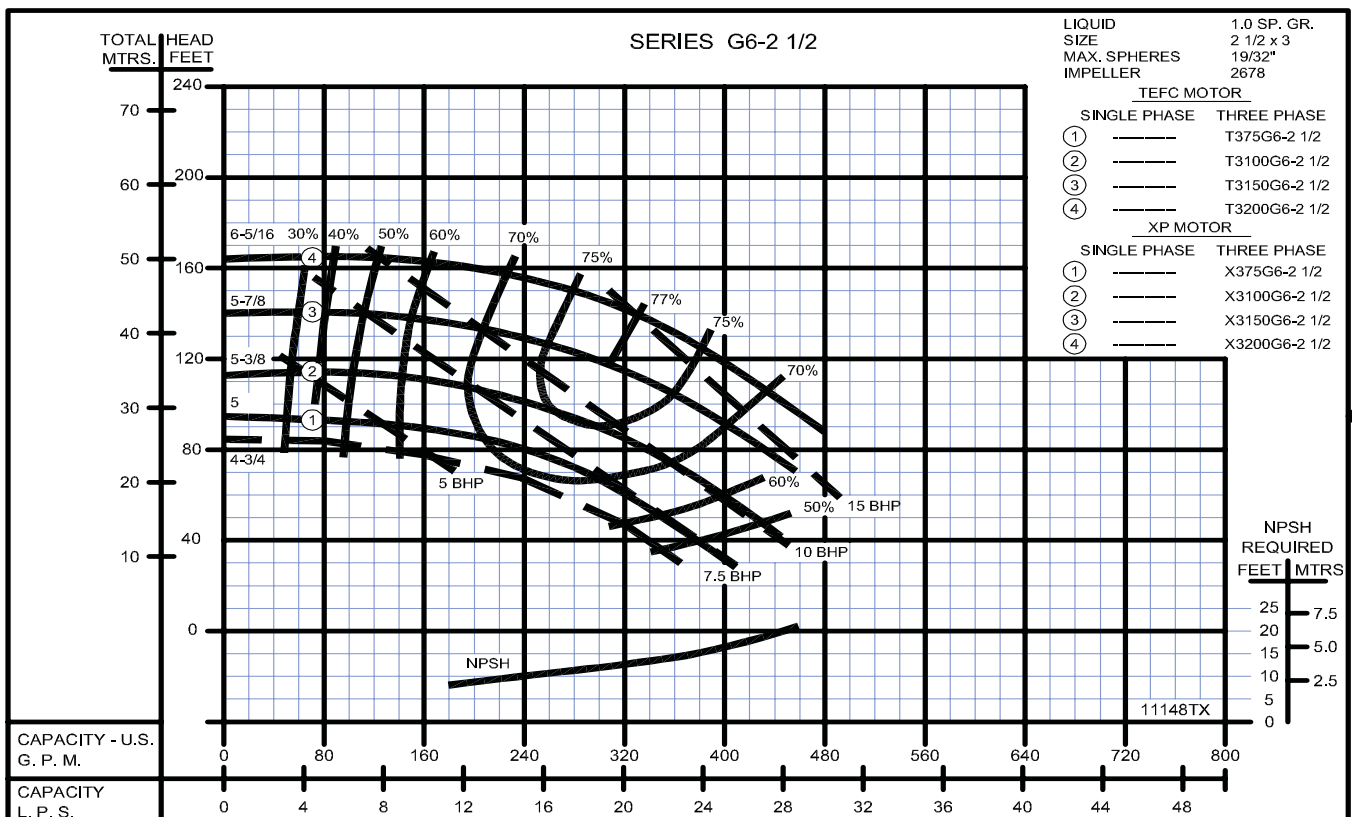

3500 RPM

Close Coupled Centrifugal Pumps



Close Coupled Centrifugal Pumps



Close Coupled Centrifugal Pumps

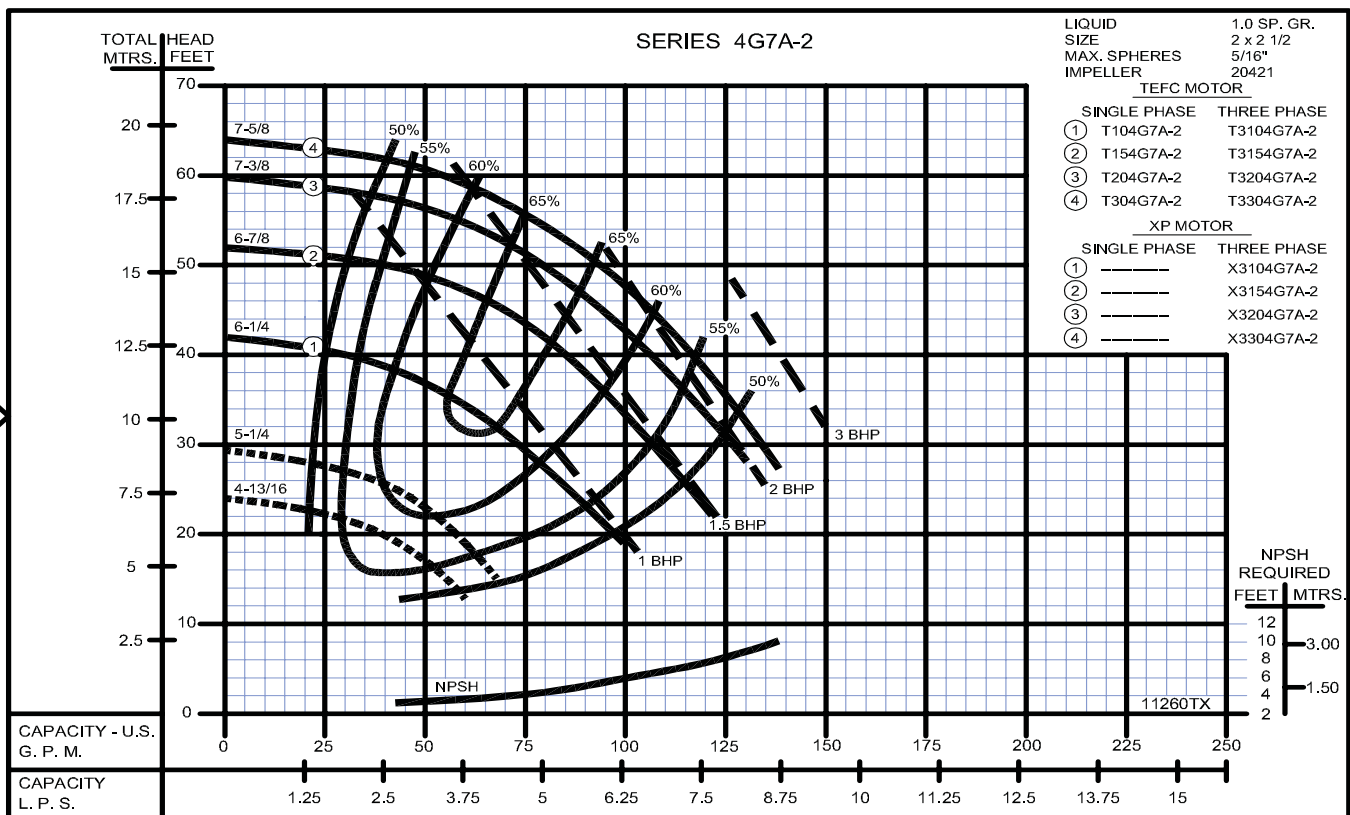
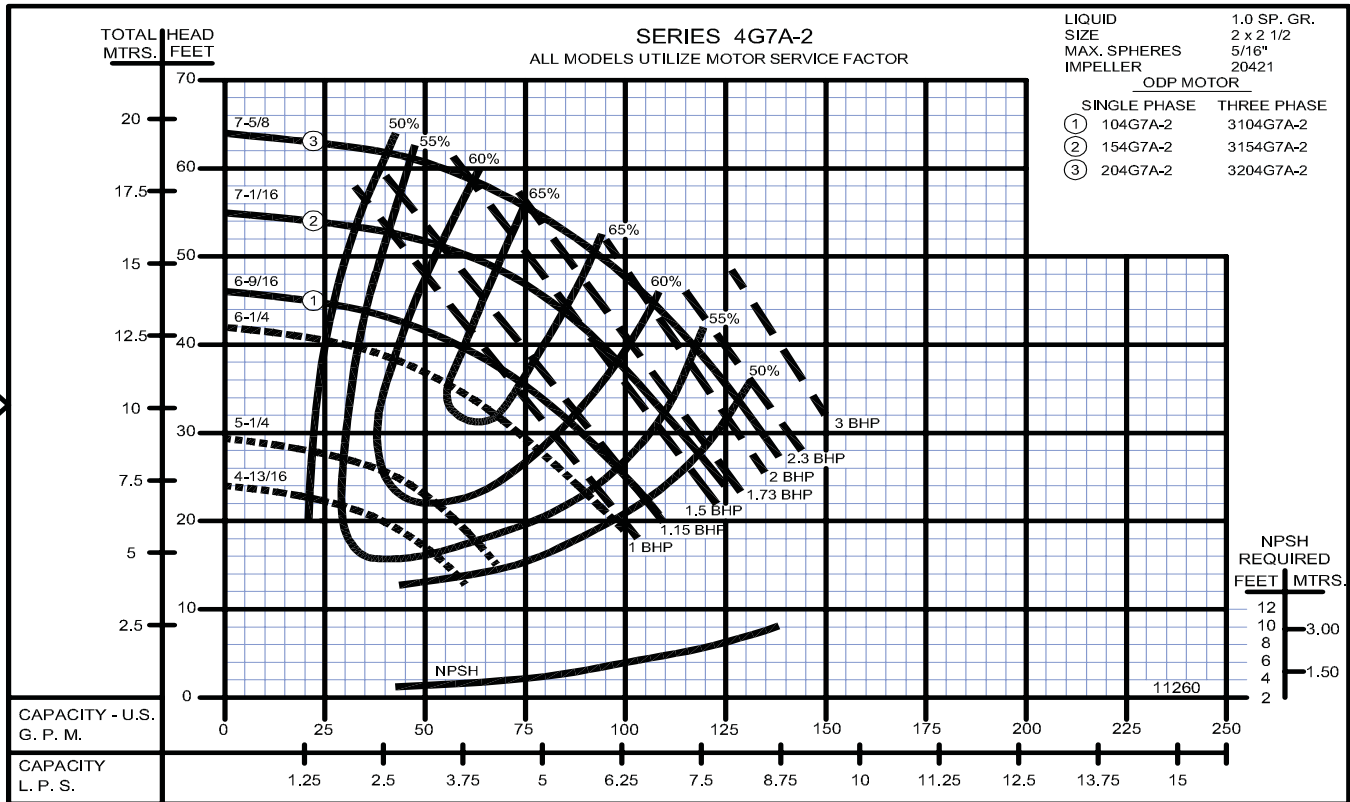

Close Coupled Centrifugal Pumps

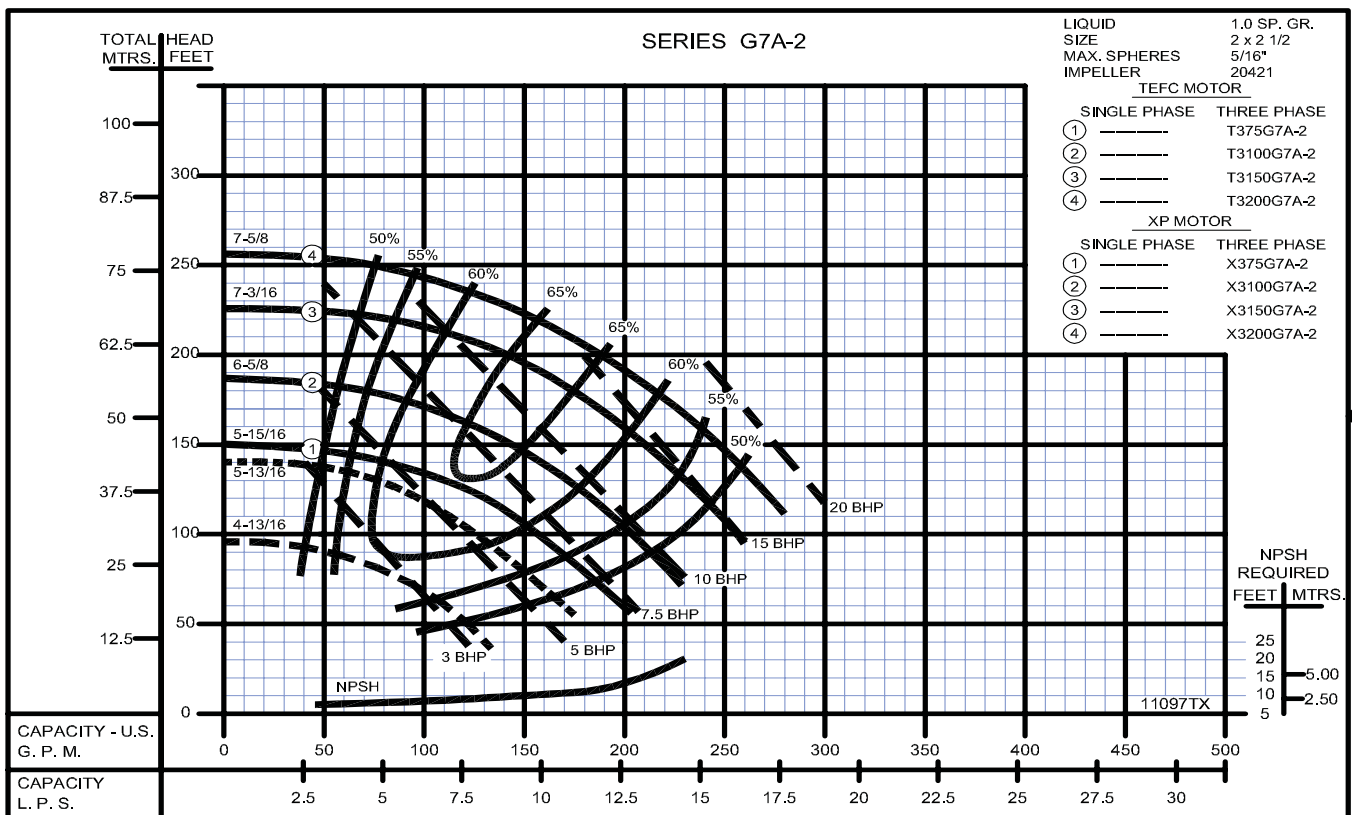
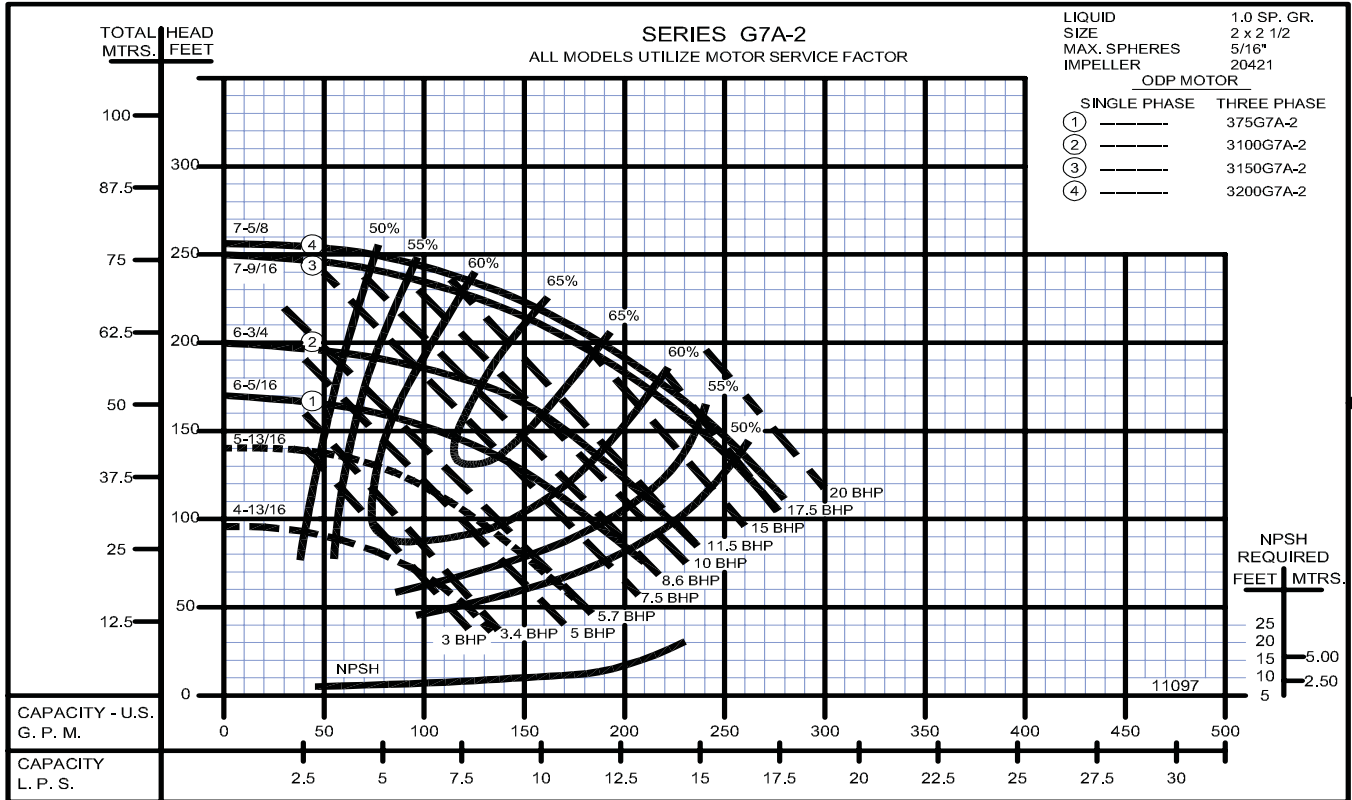

Close Coupled Centrifugal Pumps



Close Coupled Centrifugal Pumps



Close Coupled Centrifugal Pumps

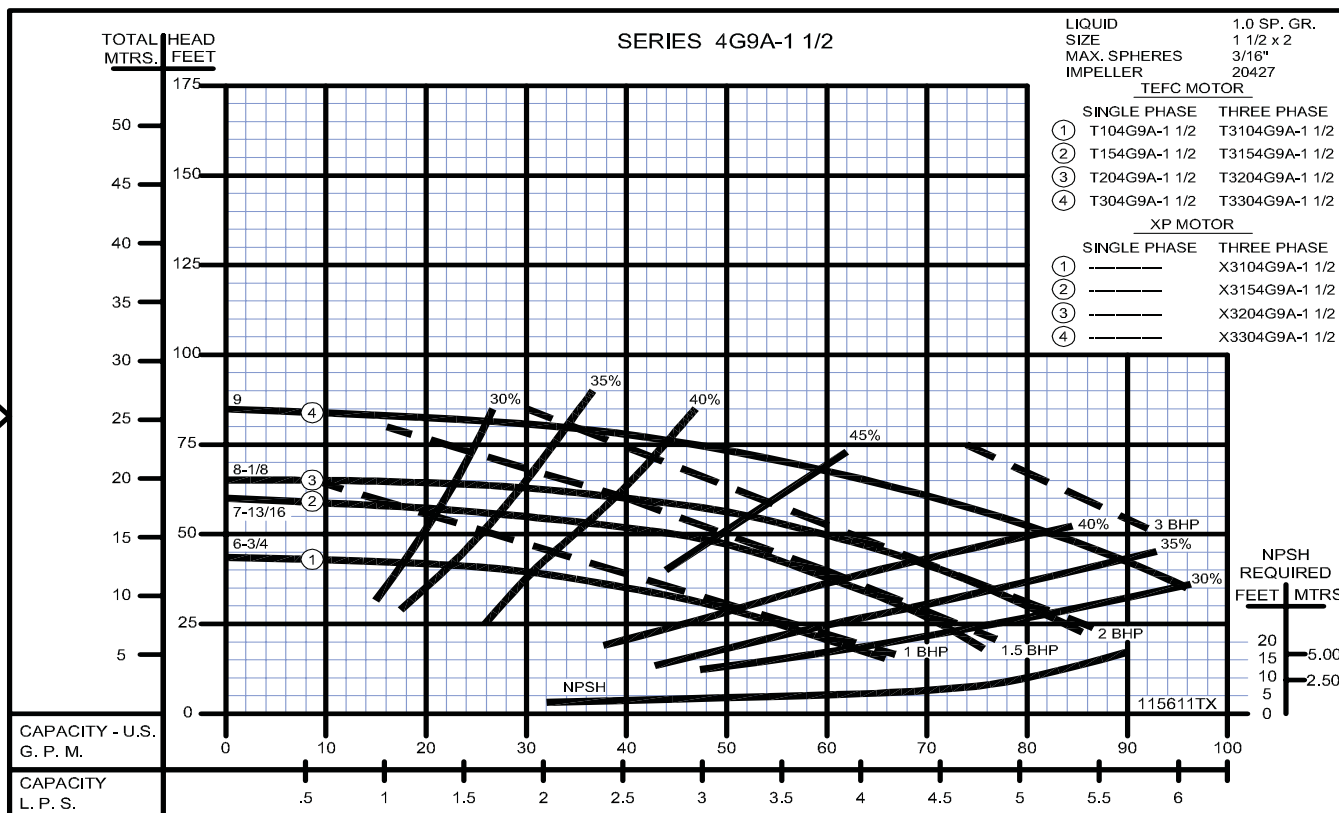
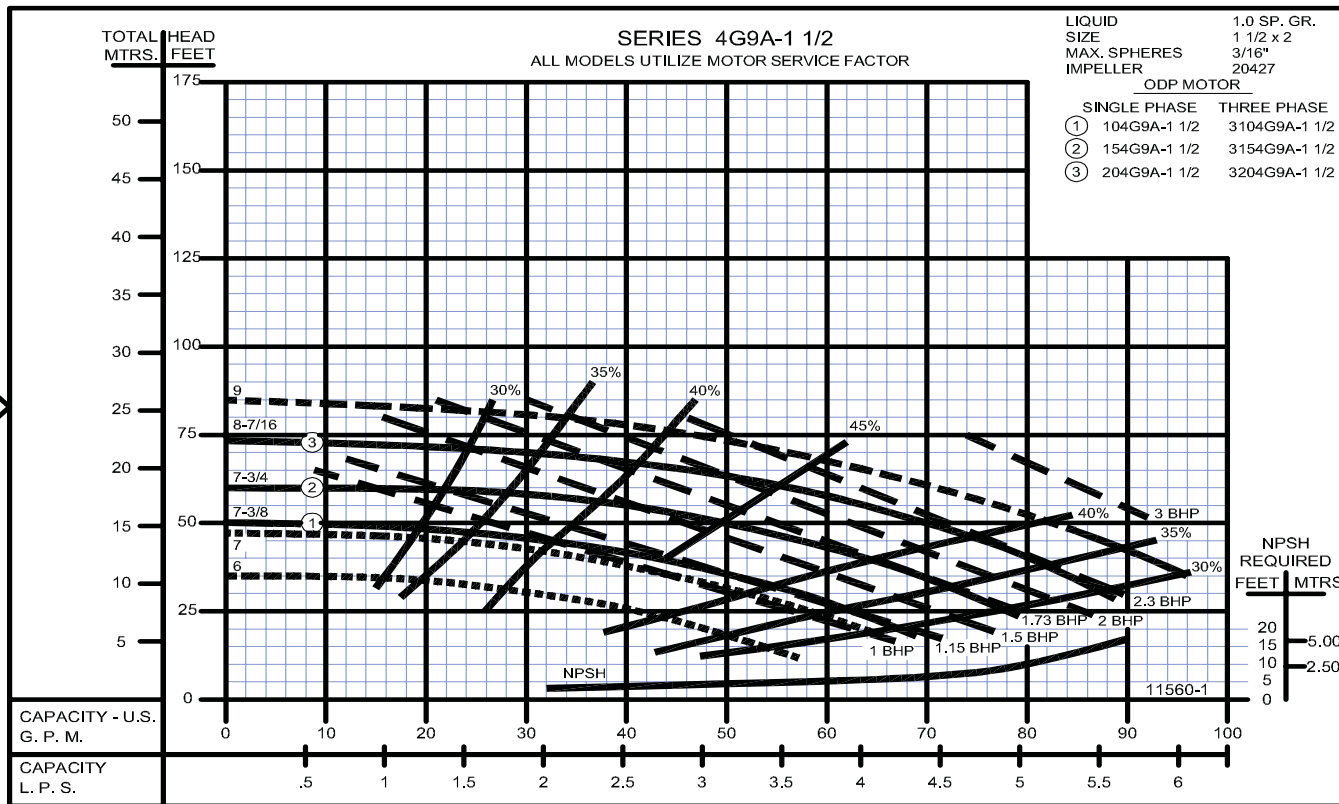

Close Coupled Centrifugal Pumps



Close Coupled Centrifugal Pumps



Close Coupled Centrifugal Pumps



Close Coupled Centrifugal Pumps



Close Coupled Centrifugal Pumps



Close Coupled Centrifugal Pumps

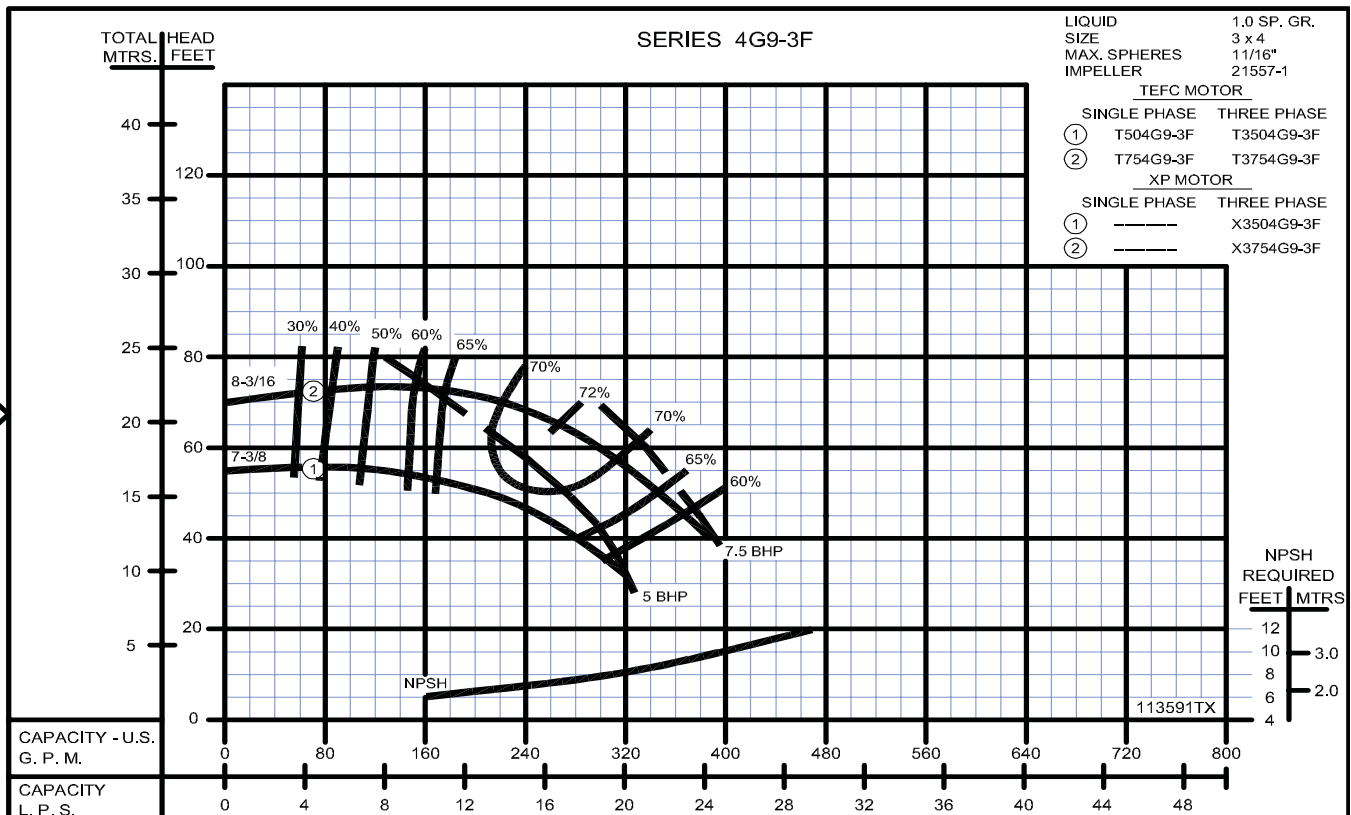
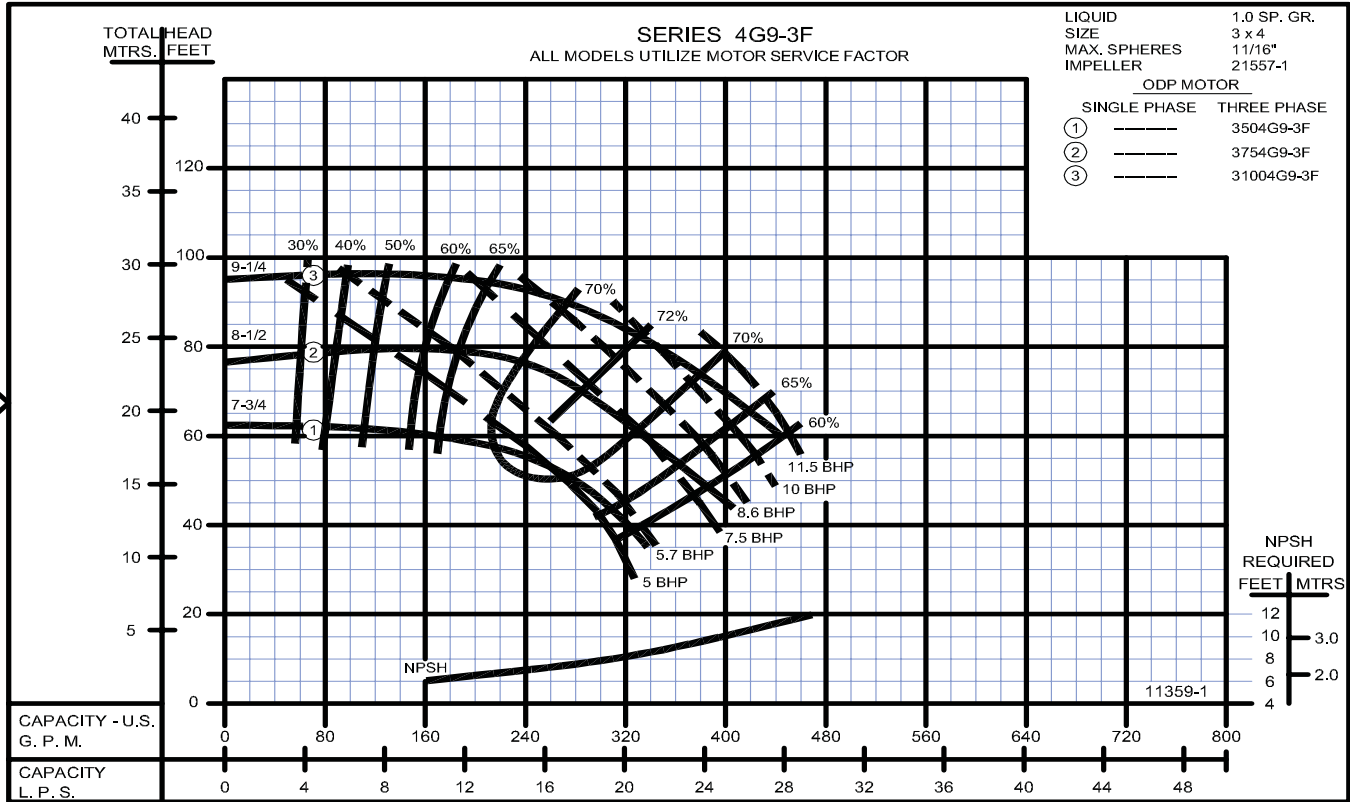

Close Coupled Centrifugal Pumps

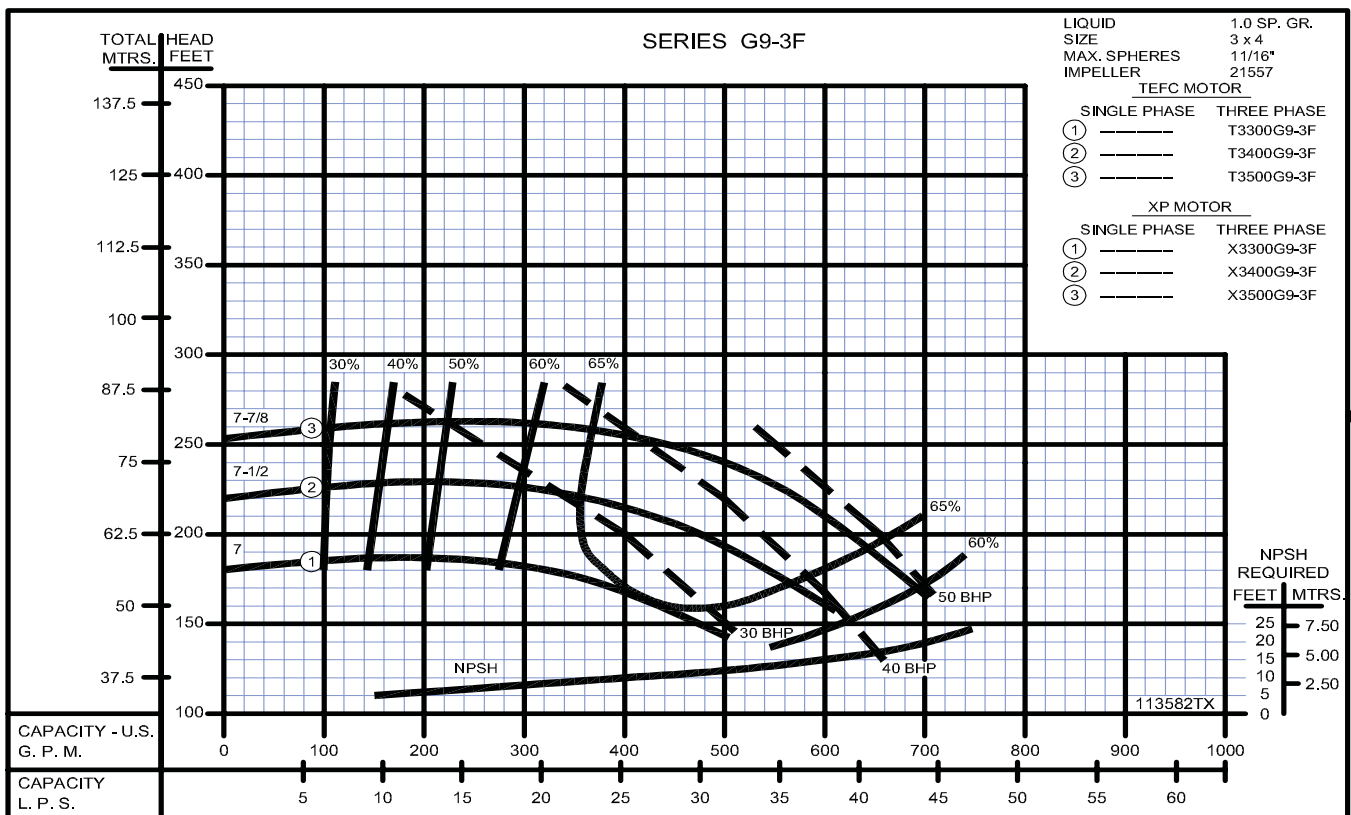
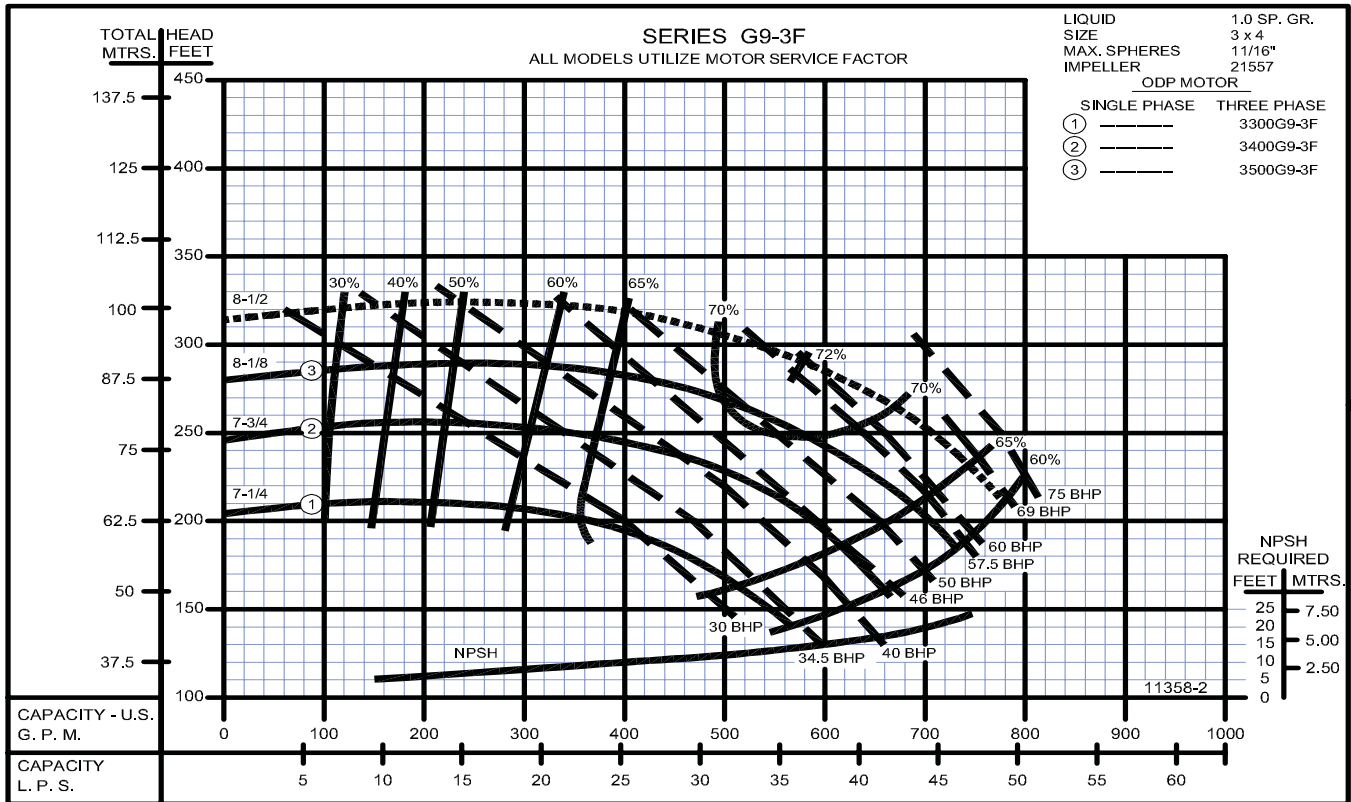

Close Coupled Centrifugal Pumps



Close Coupled Centrifugal Pumps



Close Coupled Centrifugal Pumps



Close Coupled Centrifugal Pumps



Close Coupled Centrifugal Pumps

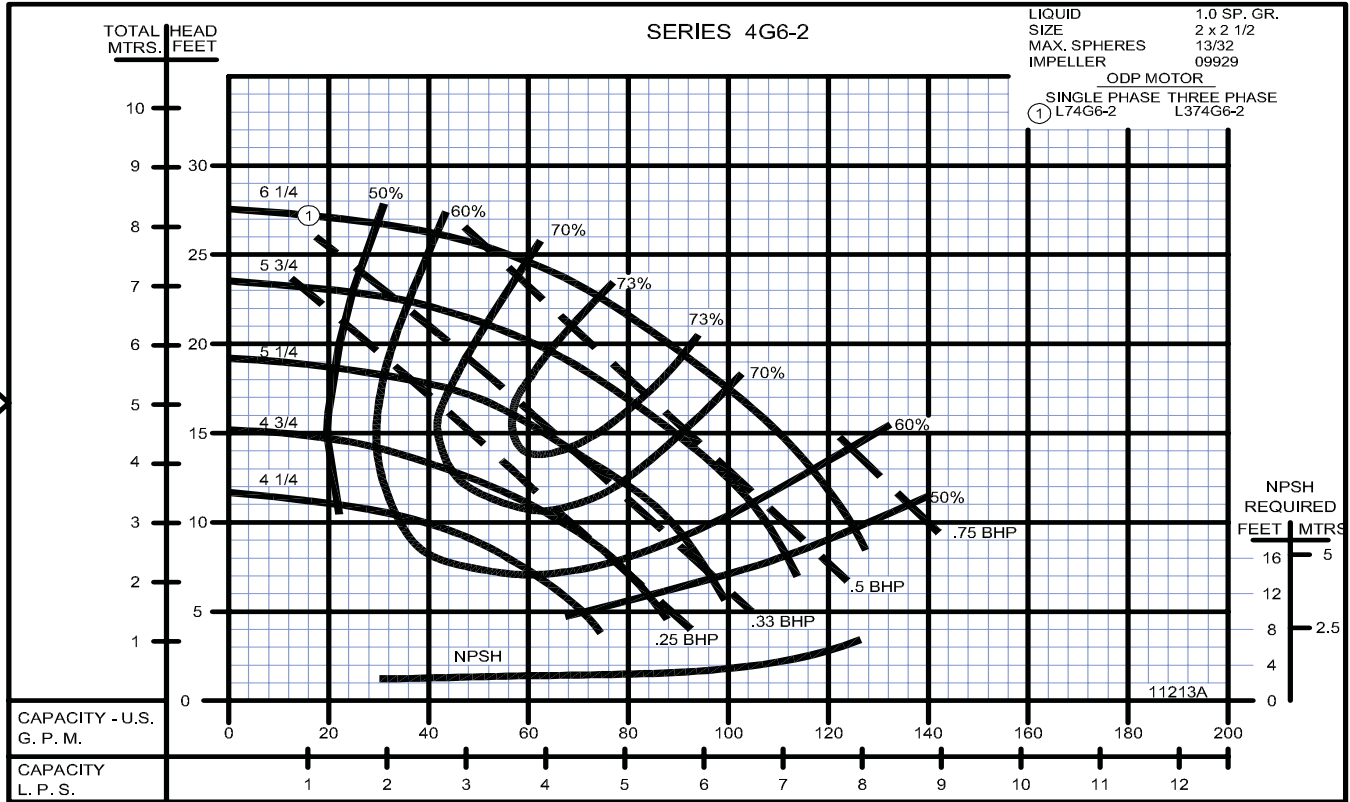

Close Coupled Centrifugal Pumps

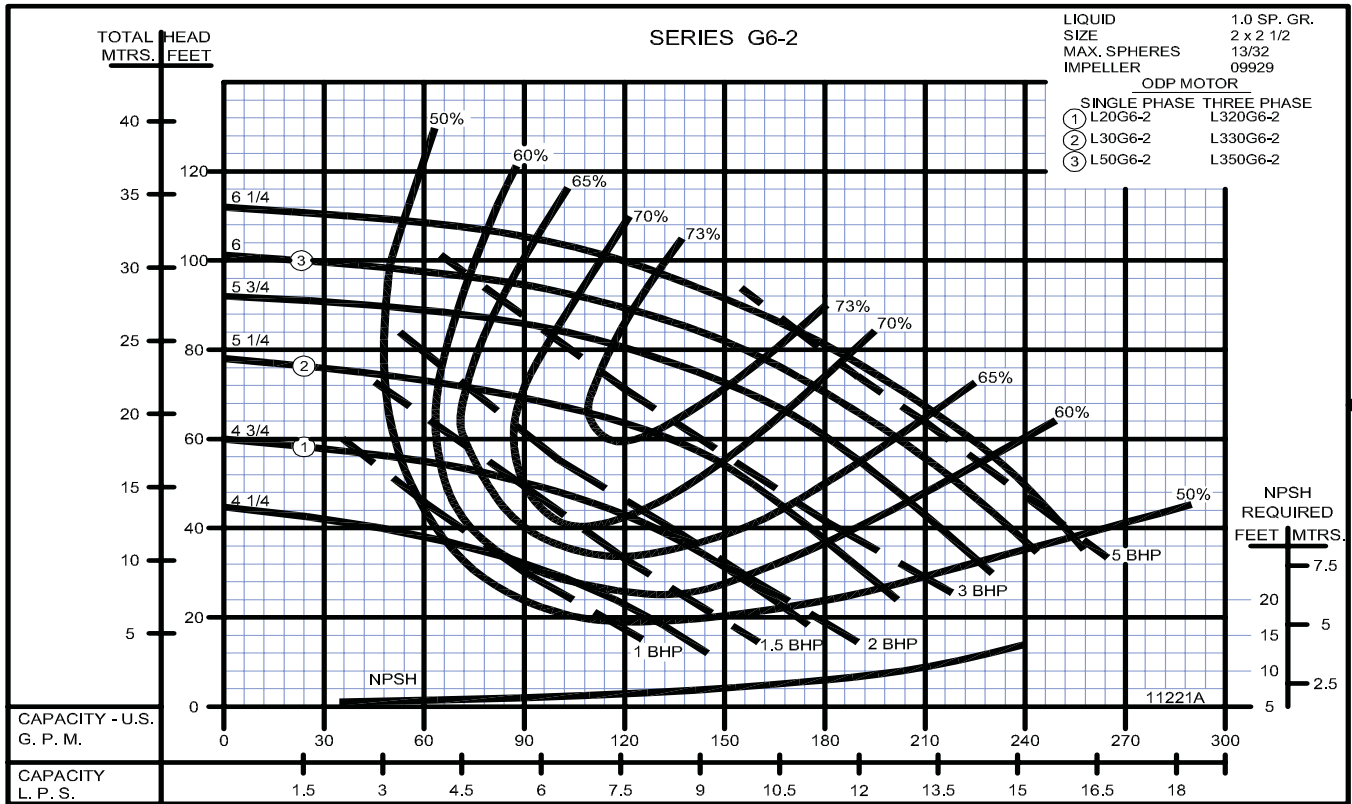

Close Coupled Centrifugal Pumps



SECTION 2B
PAGE 48
DATE 1/06



PUMPS & SYSTEMS

A Crane Co. Company

USA: (937) 778-8947 • Canada: (905) 457-6223 • International: (937) 615-3598

Close Coupled Centrifugal Pumps

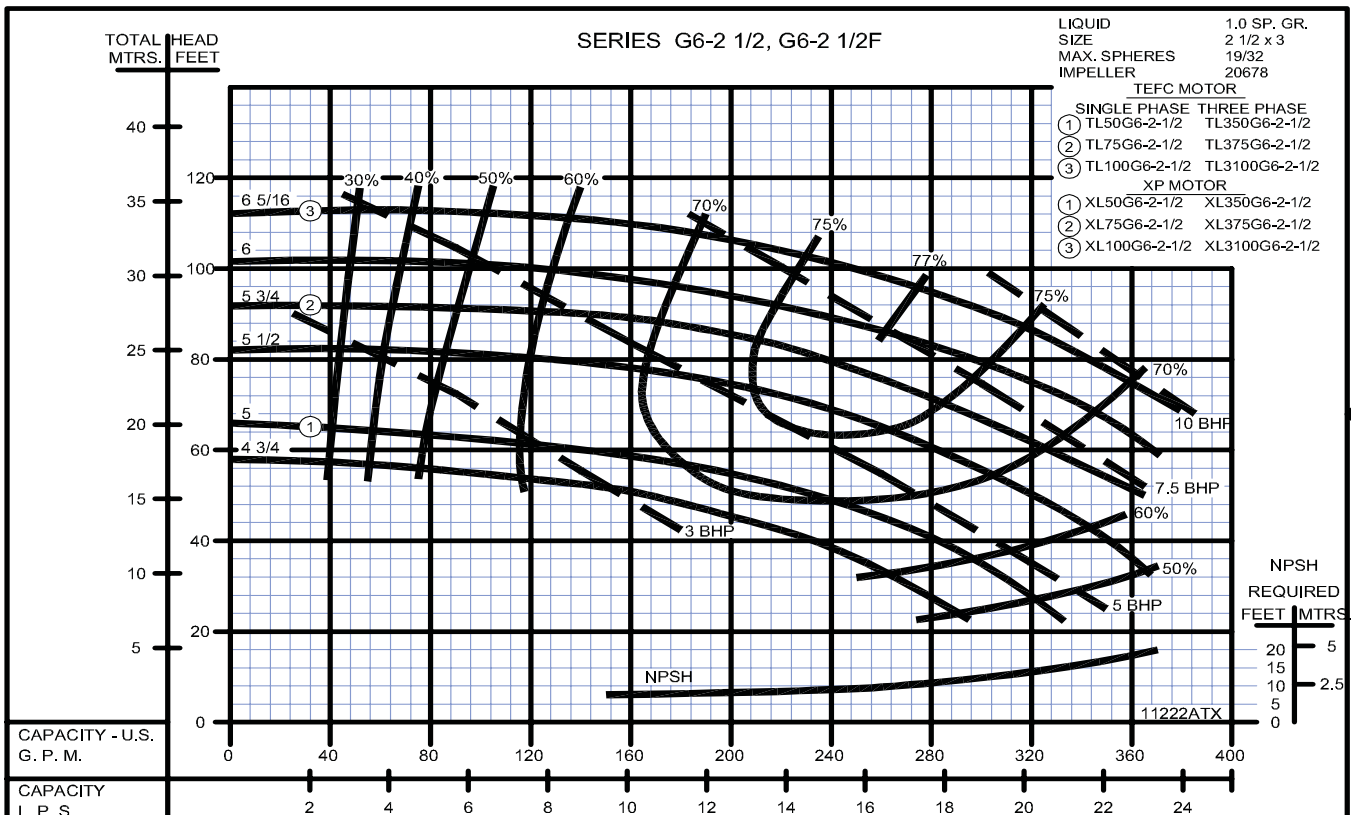
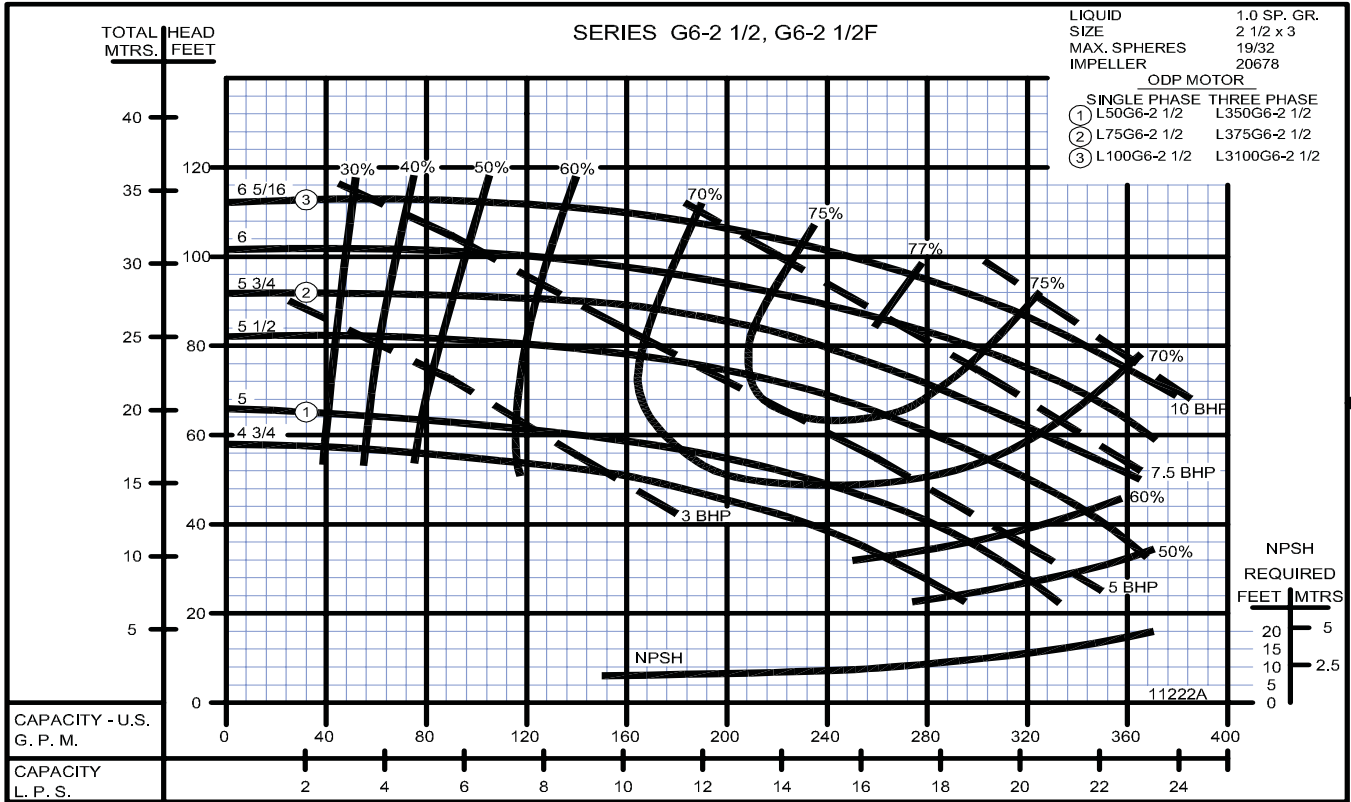

Close Coupled Centrifugal Pumps



Close Coupled Centrifugal Pumps

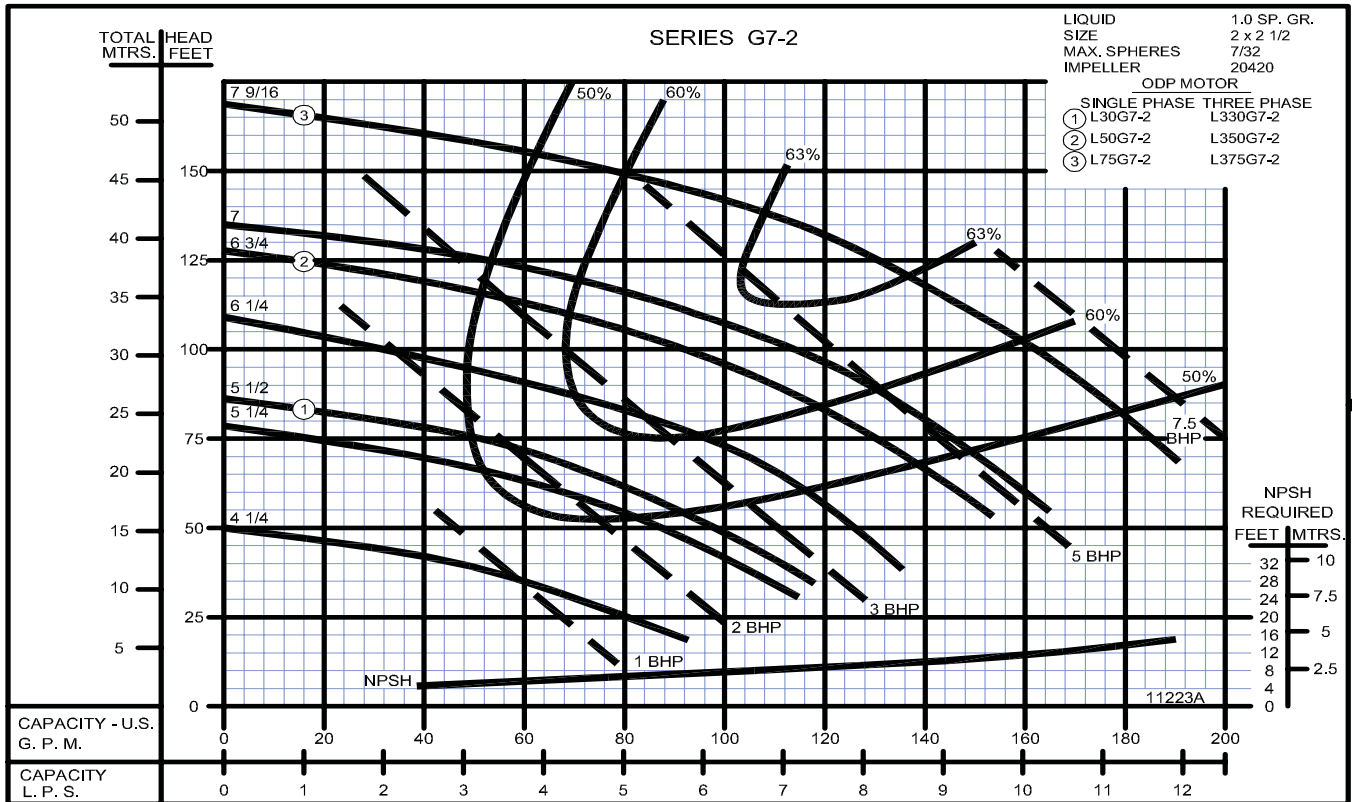

Close Coupled Centrifugal Pumps

1450 RPM

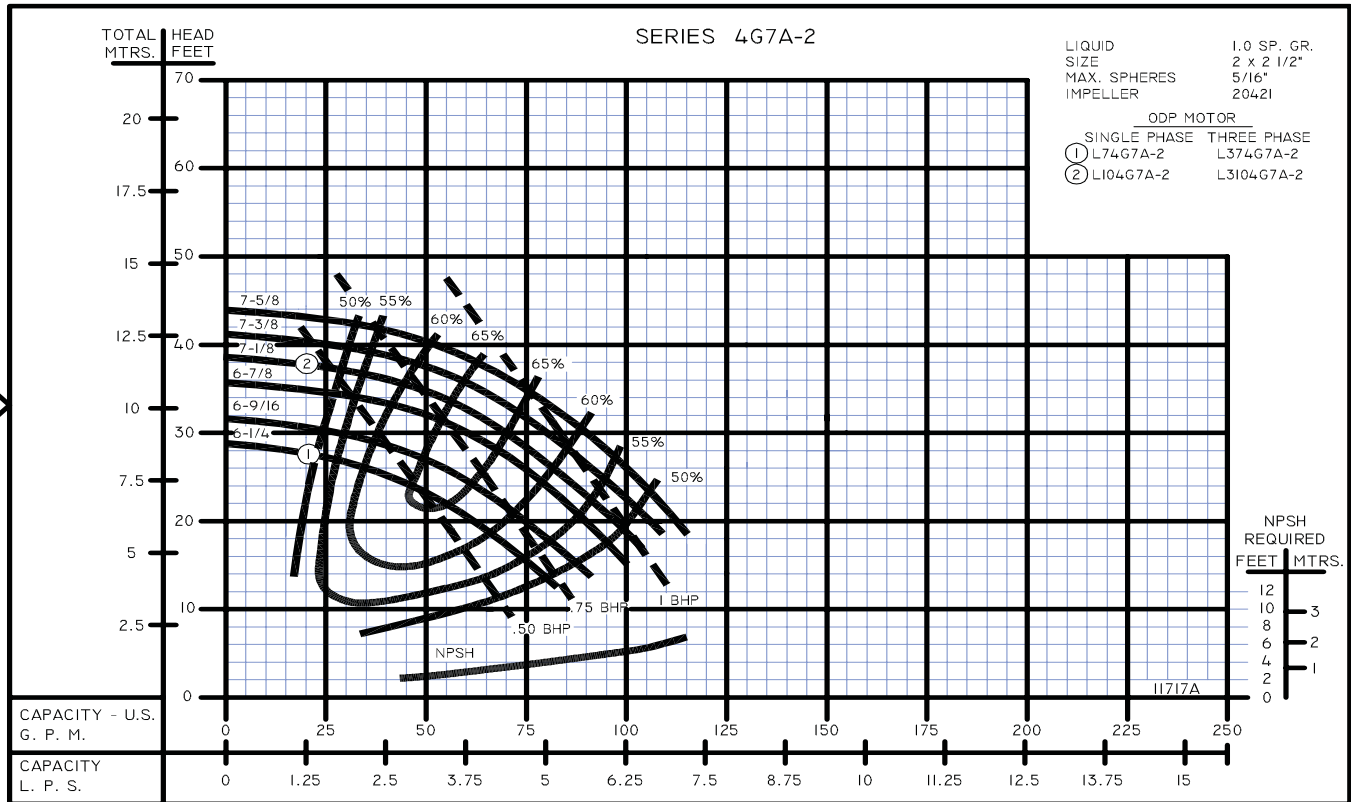

1450 RPM

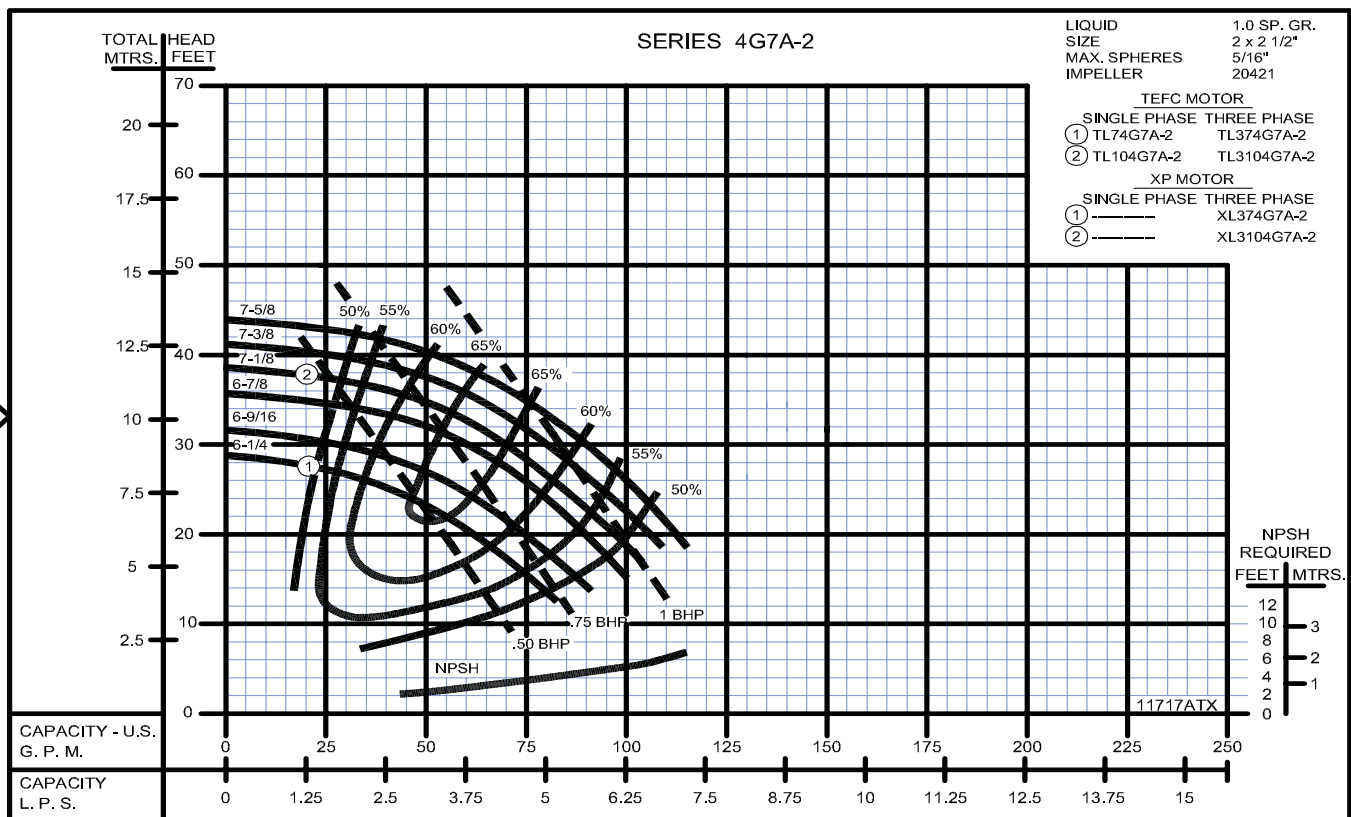

SECTION 2B
PAGE 52
DATE 1/06



PUMPS & SYSTEMS

A Crane Co. Company

USA: (937) 778-8947 • Canada: (905) 457-6223 • International: (937) 615-3598

Close Coupled Centrifugal Pumps

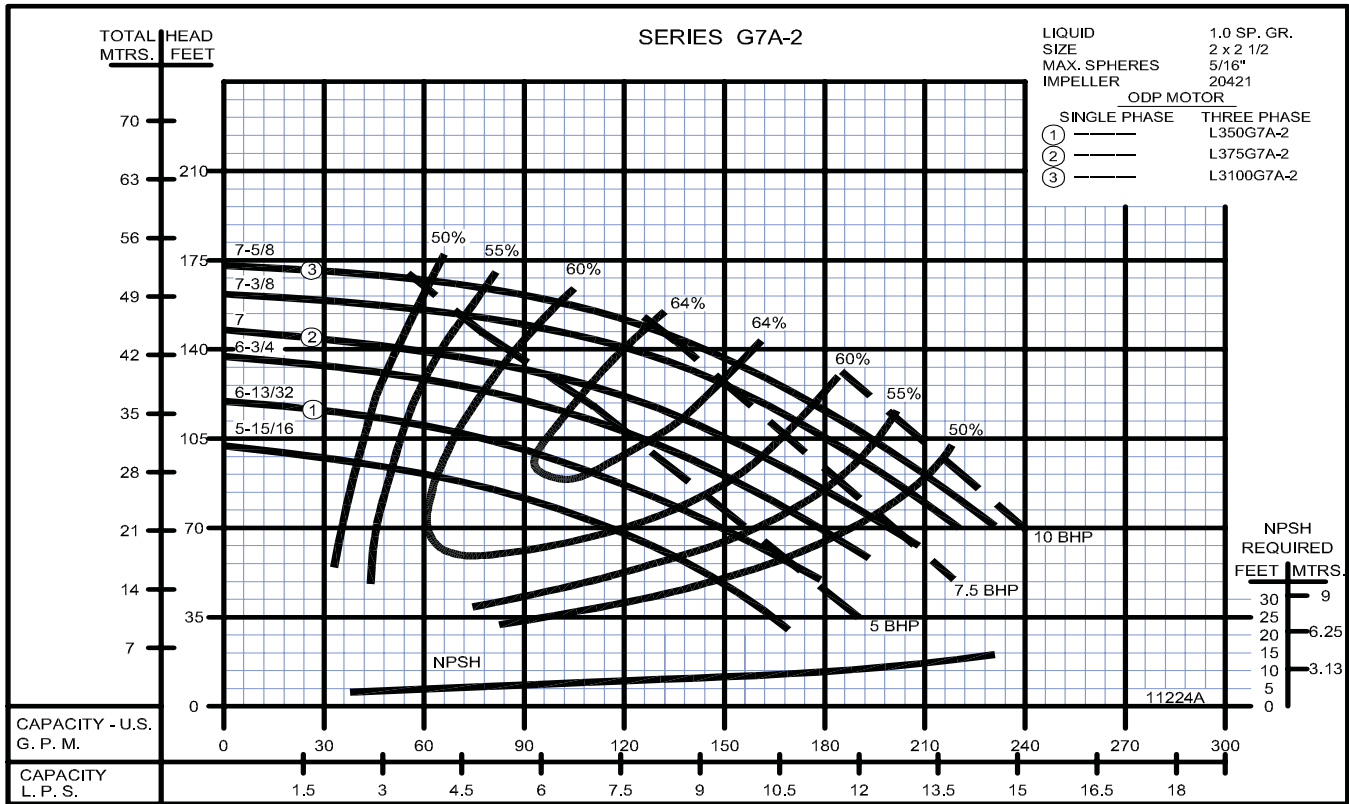

Close Coupled Centrifugal Pumps

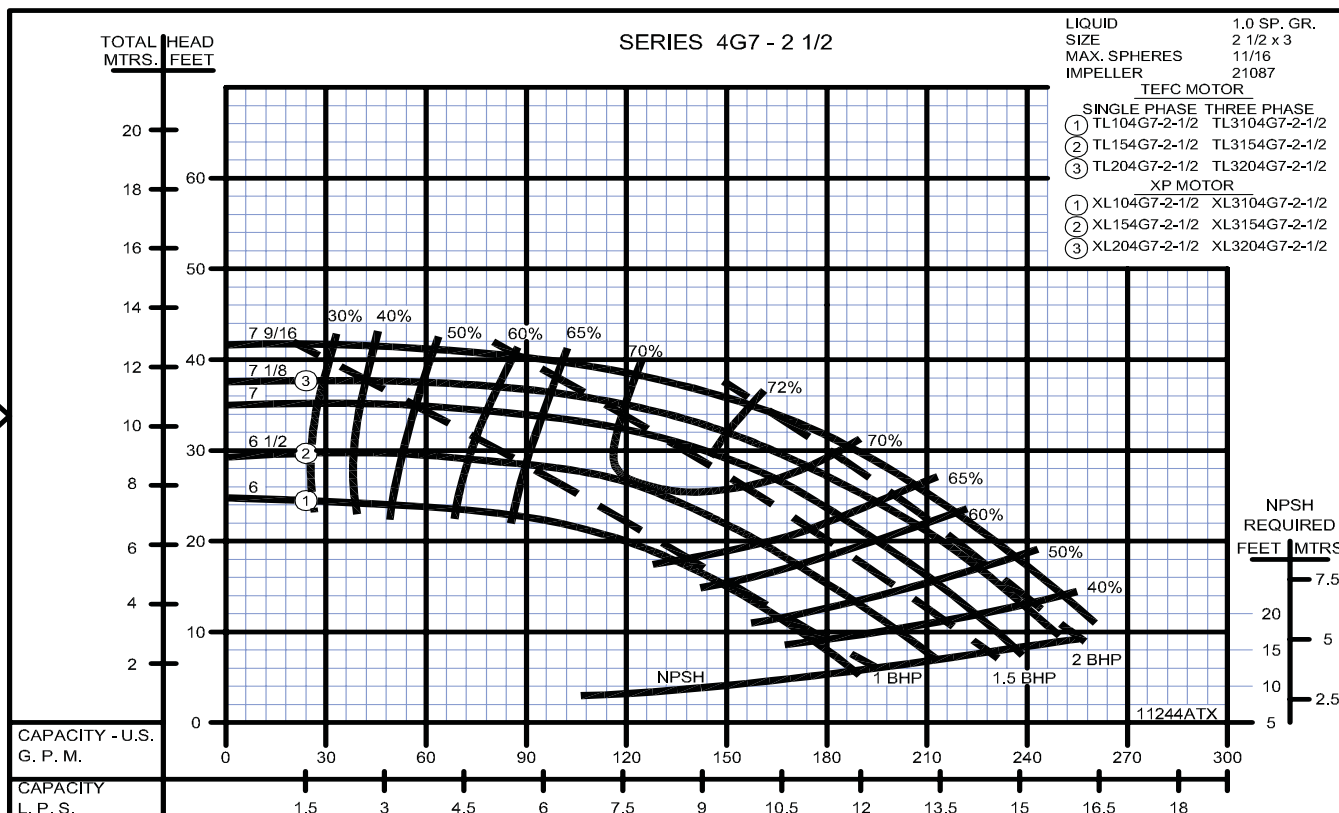
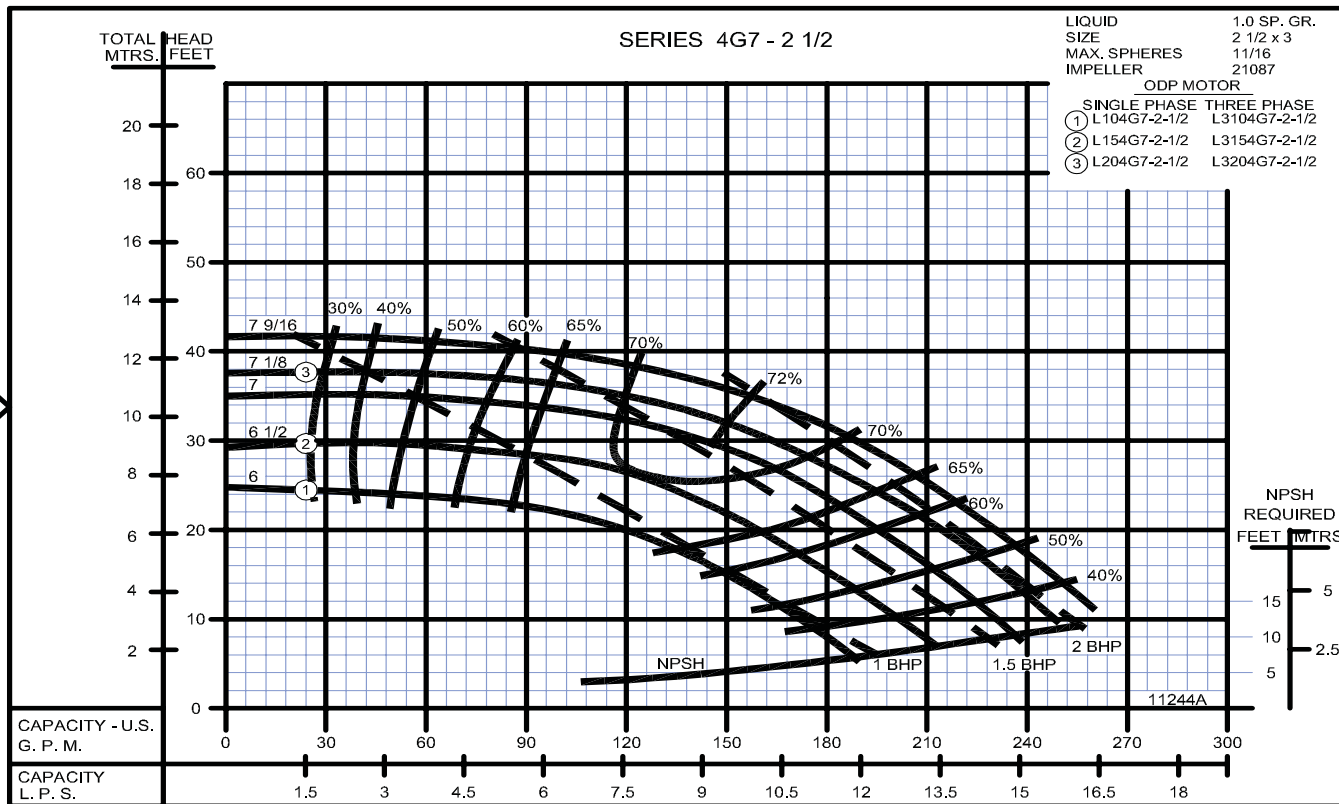

Close Coupled Centrifugal Pumps

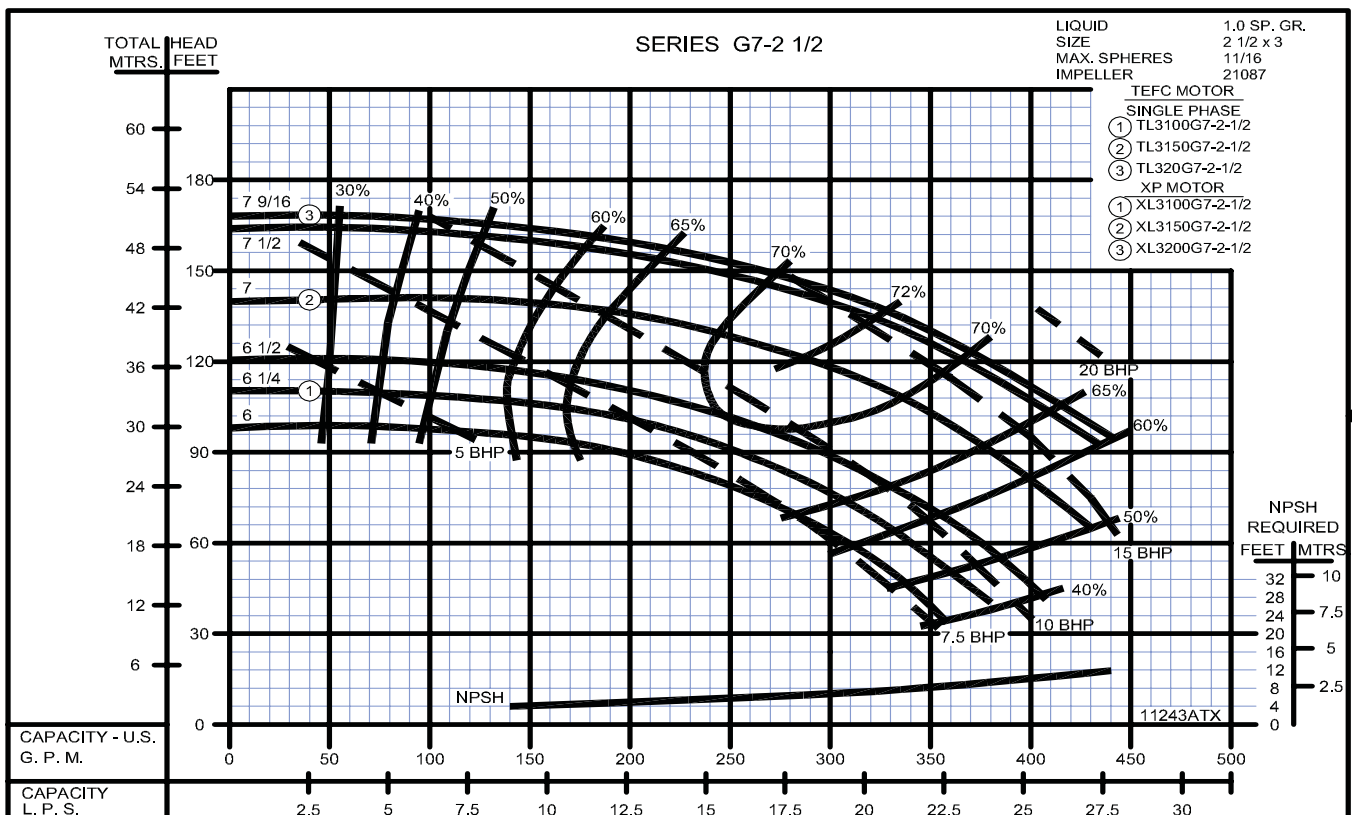
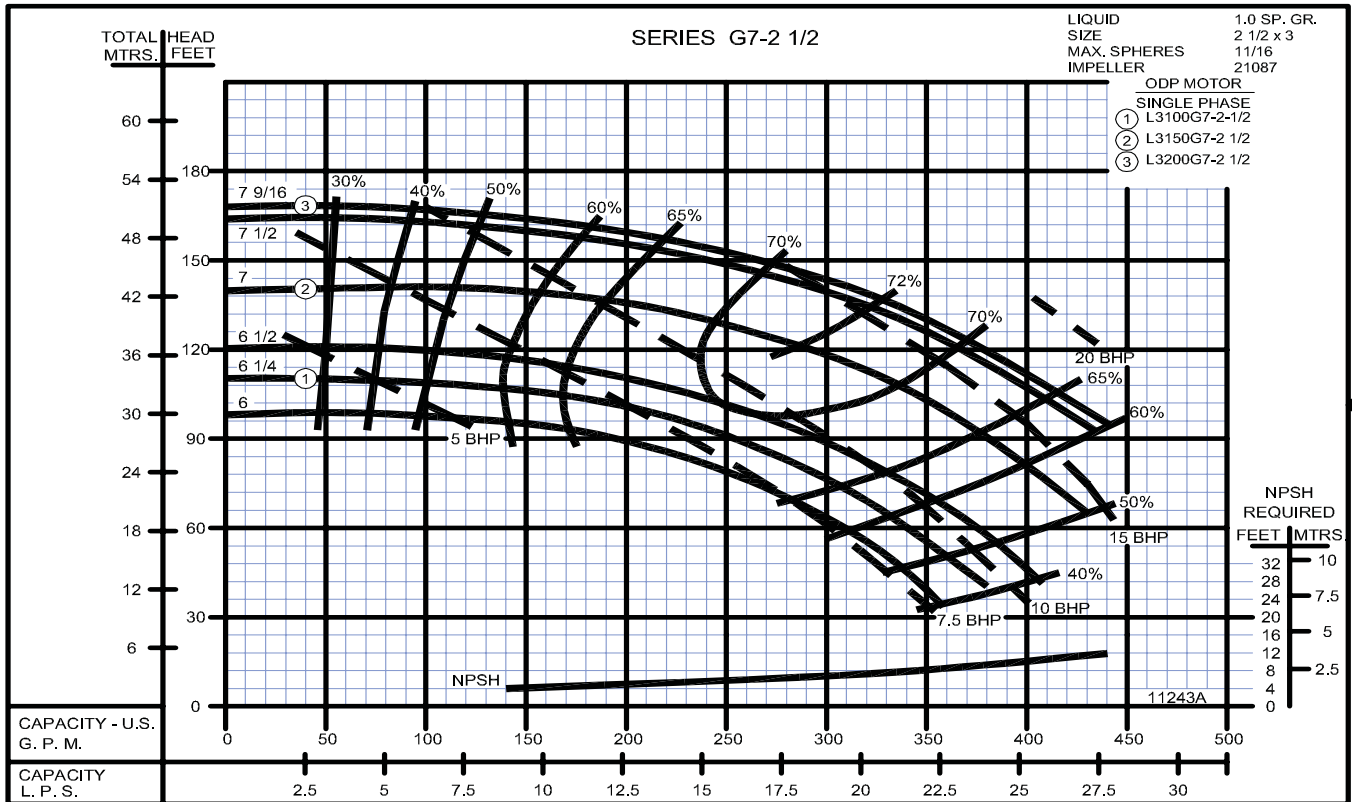

Close Coupled Centrifugal Pumps

1450 RPM

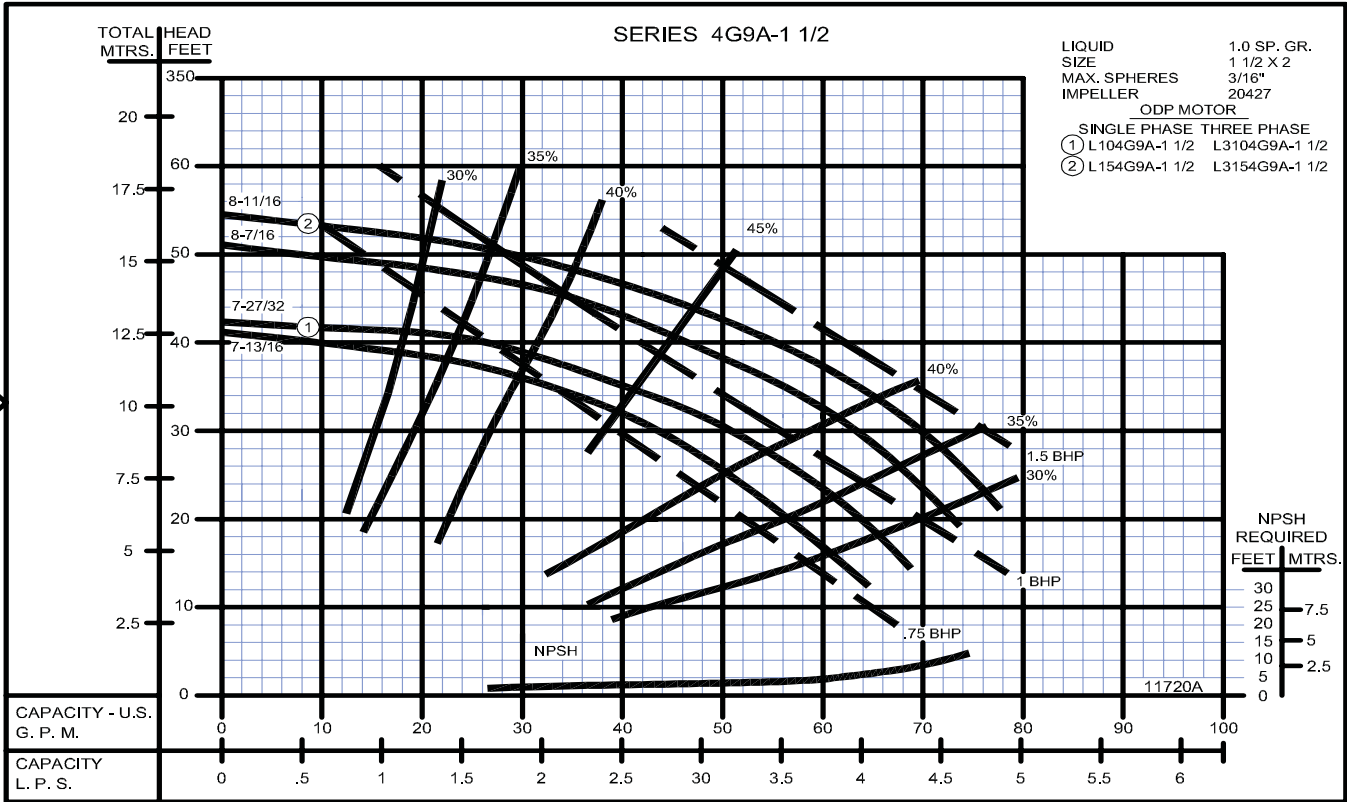

1450 RPM



Close Coupled Centrifugal Pumps



Close Coupled Centrifugal Pumps



Close Coupled Centrifugal Pumps

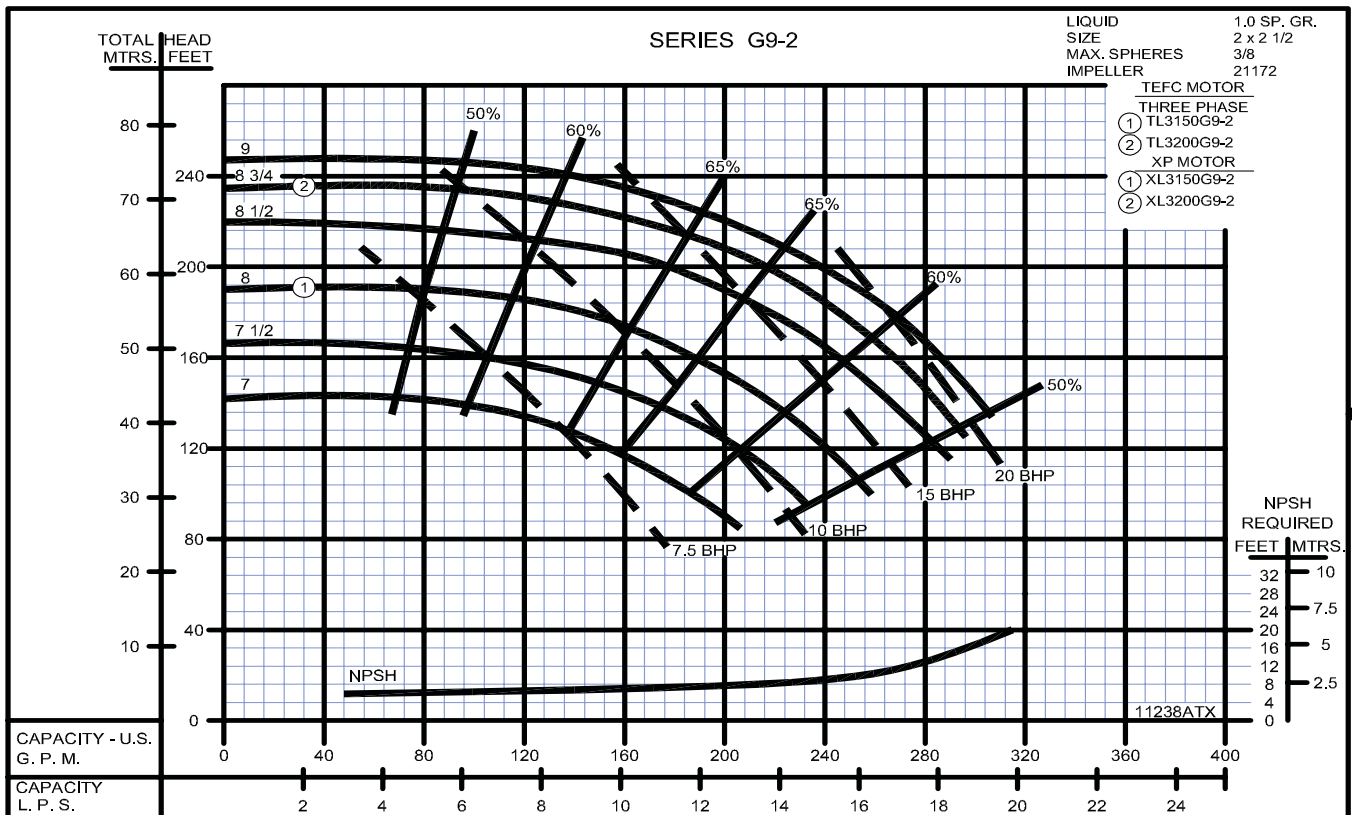
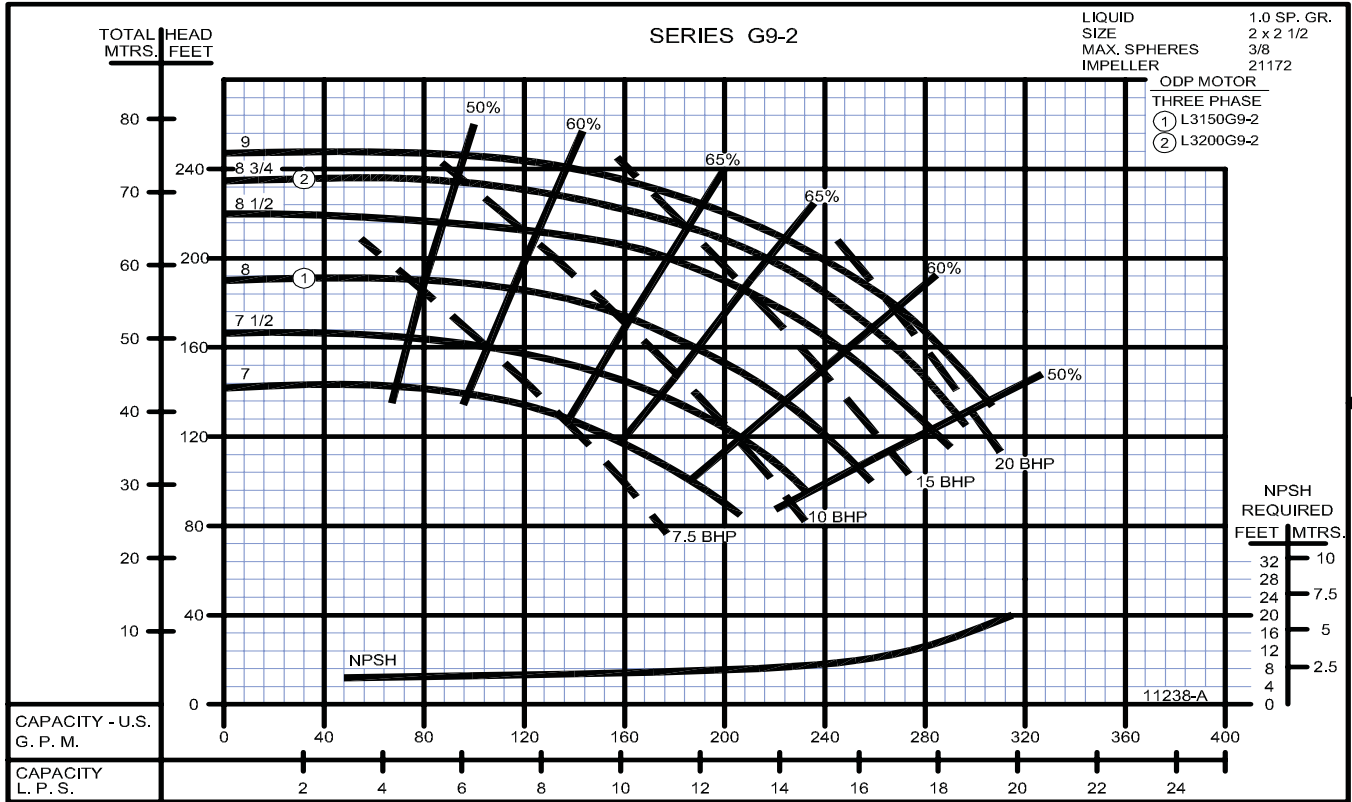

Close Coupled Centrifugal Pumps



Close Coupled Centrifugal Pumps

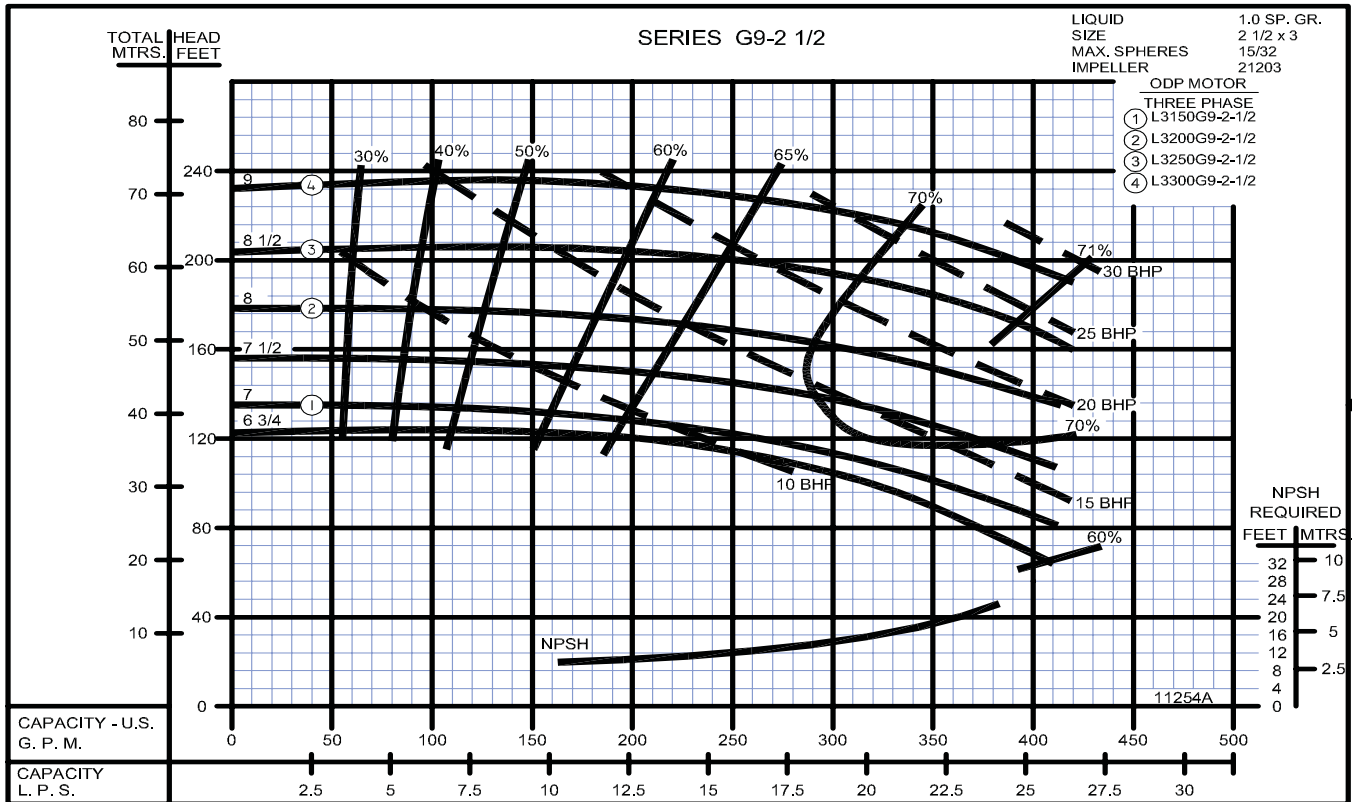

Close Coupled Centrifugal Pumps

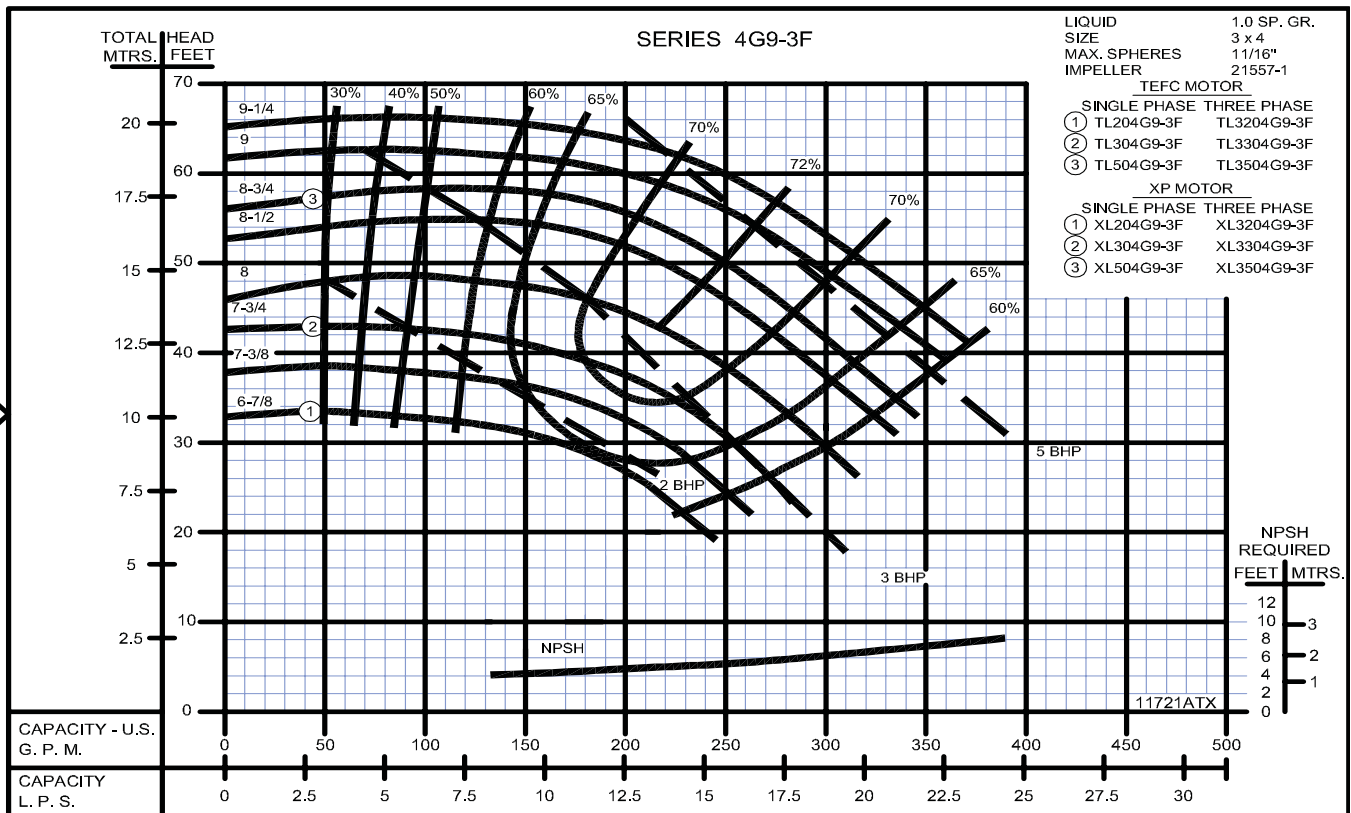
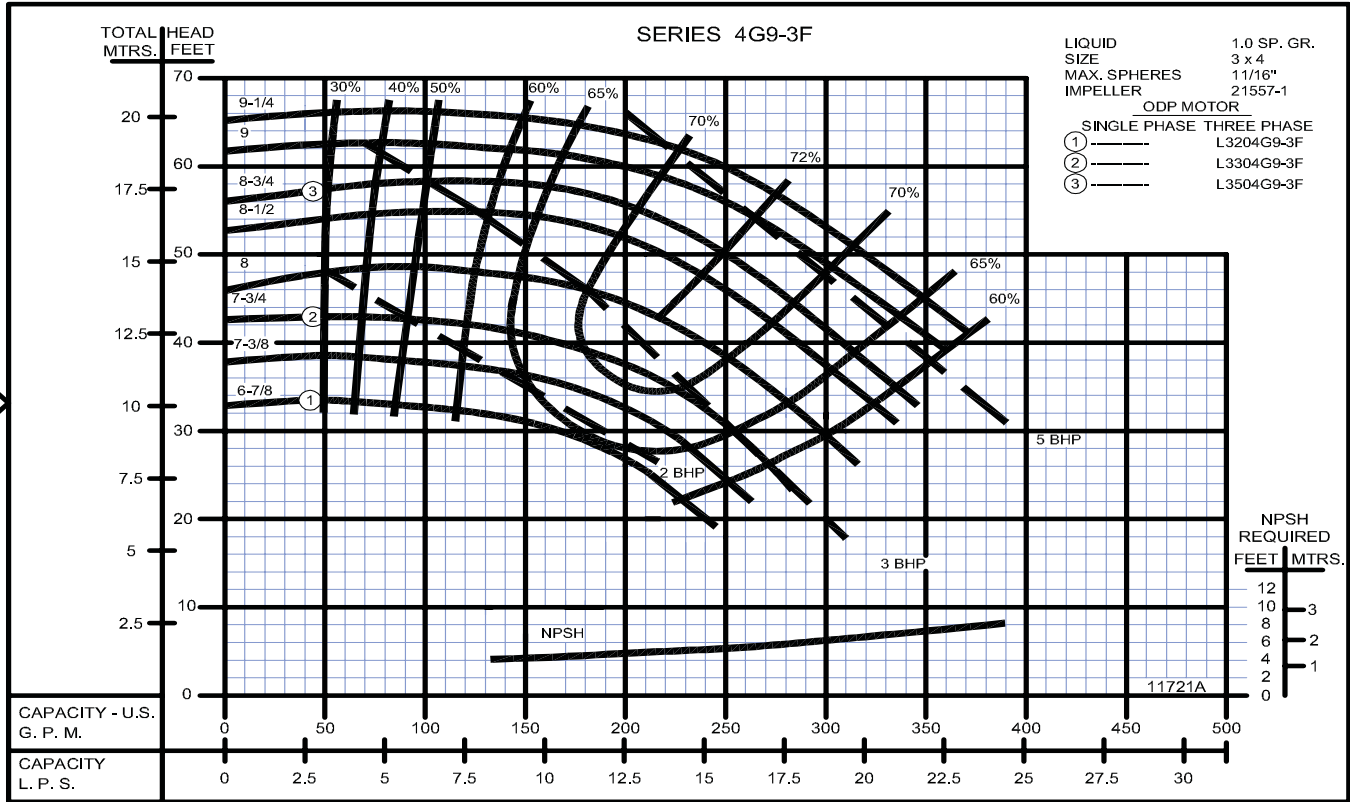

Close Coupled Centrifugal Pumps



Close Coupled Centrifugal Pumps

2900 RPM



2900 RPM



SECTION 2B
PAGE 64
DATE 1/06



PUMPS & SYSTEMS

A Crane Co. Company

USA: (937) 778-8947 • Canada: (905) 457-6223 • International: (937) 615-3598

Close Coupled Centrifugal Pumps

