

# END-SUCTION CENTRIFUGAL STAINLESS STEEL

Series: PS  
1 - 15 HP



## SUCTION

2" & 2½", 150 lb ANSI, flange horizontal.

## DISCHARGE

1¼", 1½" & 2", 150 lb ANSI, flange vertical.

## LIQUID TEMPERATURE

212 °F (100 °C); with seal for high temperature rises up to 250 °F (121 °C).

## MAX. WORK PRESSURE

230 psi (16.1 kg/cm<sup>2</sup>).

## BODY

304 series stainless steel.

## SEAL PLATE

304 series stainless steel.

## IMPELLER

**Design:** close type.

**Material:** 304 series stainless steel.

## SEAL

**Design:** mechanical type 21, lubricated by water.

**Material:** ceramic stationary part, carbon ring seal and exclusion in the rotating part. Buna-N elastomer and stainless steel spring.

## BRACKET

Cast iron ASTM, class 30.

## HARDWARE

304 series stainless steel.

## O-RING

Buna-N.

## SHAFT SLEEVE

316 series stainless steel

## MOTOR

NEMA JM, TEFC; 60 Hz, 3500 RPM (2 poles) and 1750 RPM (4 poles), 230/460 volts three phase.

Requires overload protection to be included in control panel.

## ACCESSORIES

Gaskets are included for suction and discharge flanges, plus the motor support.

## OPTIONAL EQUIPMENT

Viton<sup>®</sup> seal for high temperature.

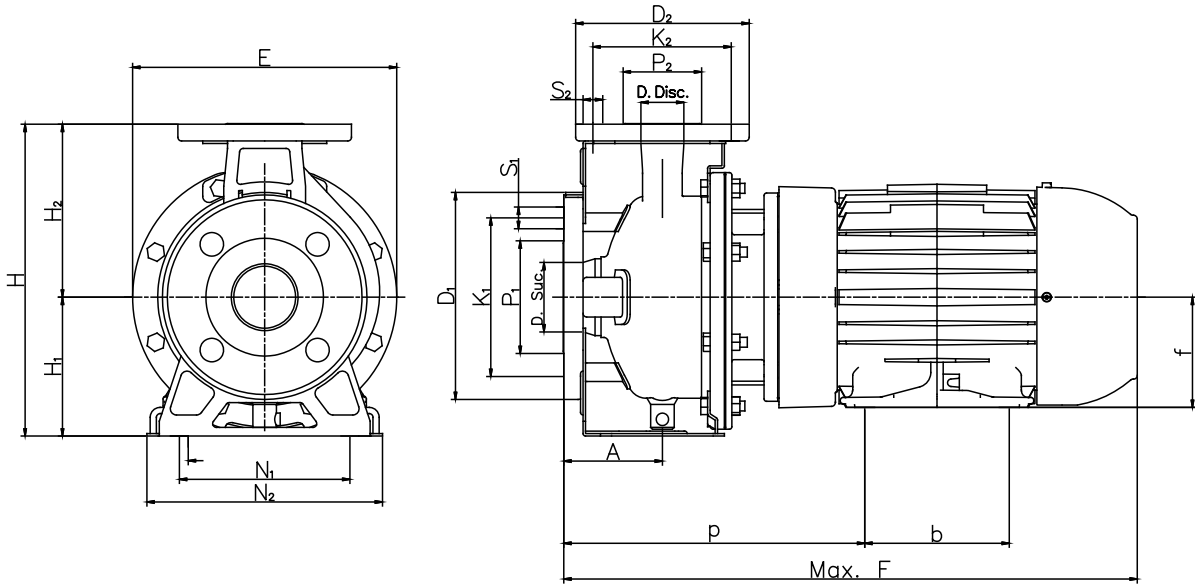

MODEL	HP	SIZE	FLANGE										
			SUCTION					DISCHARGE					
			D	P1	K1	D1	S1	D	P2	K2	D2	S2	
PS1¼-1-4	1	2 x 1¼ x 7 <sup>5</sup> / <sub>16</sub>	2	3 <sup>3</sup> / <sub>4</sub>	4 <sup>15</sup> / <sub>16</sub>	6½	1 <sup>1</sup> / <sub>16</sub>	1¼	2½	3½	5½	5 <sup>5</sup> / <sub>8</sub>	
PS1¼-1.5-4	1.5	2 x 1¼ x 7 <sup>7</sup> / <sub>8</sub>	2	3 <sup>3</sup> / <sub>4</sub>	4 <sup>15</sup> / <sub>16</sub>	6½	1 <sup>1</sup> / <sub>16</sub>	1¼	2½	3½	5½	5 <sup>5</sup> / <sub>8</sub>	
PS1¼-3-2	3	2 x 1¼ x 5 <sup>3</sup> / <sub>16</sub>	2	3 <sup>3</sup> / <sub>4</sub>	4 <sup>15</sup> / <sub>16</sub>	6½	1 <sup>1</sup> / <sub>16</sub>	1¼	2½	3½	5½	5 <sup>5</sup> / <sub>8</sub>	
PS1¼-5-2	5	2 x 1¼ x 6 <sup>9</sup> / <sub>16</sub>	2	3 <sup>3</sup> / <sub>4</sub>	4 <sup>15</sup> / <sub>16</sub>	6½	1 <sup>1</sup> / <sub>16</sub>	1¼	2½	3½	5½	5 <sup>5</sup> / <sub>8</sub>	
PS1¼-7.5-2	7.5	2 x 1¼ x 7 <sup>15</sup> / <sub>16</sub>	2	3 <sup>3</sup> / <sub>4</sub>	4 <sup>15</sup> / <sub>16</sub>	6½	1 <sup>1</sup> / <sub>16</sub>	1¼	2½	3½	5½	5 <sup>5</sup> / <sub>8</sub>	
PS1¼-10-2	10	2 x 1¼ x 7 <sup>7</sup> / <sub>8</sub>	2	3 <sup>3</sup> / <sub>4</sub>	4 <sup>15</sup> / <sub>16</sub>	6½	1 <sup>1</sup> / <sub>16</sub>	1¼	2½	3½	5½	5 <sup>5</sup> / <sub>8</sub>	
PS1½-5-2	5	2½ x 1½ x 5½	2½	4 <sup>9</sup> / <sub>16</sub>	5 <sup>11</sup> / <sub>16</sub>	7 <sup>5</sup> / <sub>16</sub>	1 <sup>1</sup> / <sub>16</sub>	1½	2 <sup>7</sup> / <sub>8</sub>	3 <sup>7</sup> / <sub>8</sub>	5 <sup>7</sup> / <sub>8</sub>	5 <sup>5</sup> / <sub>8</sub>	
PS1½-7.5-2	7.5	2½ x 1½ x 5 <sup>15</sup> / <sub>16</sub>	2½	4 <sup>9</sup> / <sub>16</sub>	5 <sup>11</sup> / <sub>16</sub>	7 <sup>5</sup> / <sub>16</sub>	1 <sup>1</sup> / <sub>16</sub>	1½	2 <sup>7</sup> / <sub>8</sub>	3 <sup>7</sup> / <sub>8</sub>	5 <sup>7</sup> / <sub>8</sub>	5 <sup>5</sup> / <sub>8</sub>	
PS1½-10-2	10	2½ x 1½ x 6 <sup>9</sup> / <sub>16</sub>	2½	4 <sup>9</sup> / <sub>16</sub>	5 <sup>11</sup> / <sub>16</sub>	7 <sup>5</sup> / <sub>16</sub>	1 <sup>1</sup> / <sub>16</sub>	1½	2 <sup>7</sup> / <sub>8</sub>	3 <sup>7</sup> / <sub>8</sub>	5 <sup>7</sup> / <sub>8</sub>	5 <sup>5</sup> / <sub>8</sub>	
PS1½-15-2	15	2½ x 1½ x 7 <sup>7</sup> / <sub>8</sub>	2½	4 <sup>9</sup> / <sub>16</sub>	5 <sup>11</sup> / <sub>16</sub>	7 <sup>5</sup> / <sub>16</sub>	1 <sup>1</sup> / <sub>16</sub>	1½	2 <sup>7</sup> / <sub>8</sub>	3 <sup>7</sup> / <sub>8</sub>	5 <sup>7</sup> / <sub>8</sub>	5 <sup>5</sup> / <sub>8</sub>	
PS2-2-4	2	2½ x 2 x 6 <sup>9</sup> / <sub>16</sub>	2½	4 <sup>9</sup> / <sub>16</sub>	5 <sup>11</sup> / <sub>16</sub>	7 <sup>5</sup> / <sub>16</sub>	1 <sup>1</sup> / <sub>16</sub>	2	3 <sup>3</sup> / <sub>4</sub>	4 <sup>15</sup> / <sub>16</sub>	6½	1 <sup>1</sup> / <sub>16</sub>	
PS2-7.5-2	7.5	2½ x 2 x 5 <sup>3</sup> / <sub>16</sub>	2½	4 <sup>9</sup> / <sub>16</sub>	5 <sup>11</sup> / <sub>16</sub>	7 <sup>5</sup> / <sub>16</sub>	1 <sup>1</sup> / <sub>16</sub>	2	3 <sup>3</sup> / <sub>4</sub>	4 <sup>15</sup> / <sub>16</sub>	6½	1 <sup>1</sup> / <sub>16</sub>	
PS2-10-2	10	2½ x 2 x 6 <sup>3</sup> / <sub>16</sub>	2½	4 <sup>9</sup> / <sub>16</sub>	5 <sup>11</sup> / <sub>16</sub>	7 <sup>5</sup> / <sub>16</sub>	1 <sup>1</sup> / <sub>16</sub>	2	3 <sup>3</sup> / <sub>4</sub>	4 <sup>15</sup> / <sub>16</sub>	6½	1 <sup>1</sup> / <sub>16</sub>	
PS2-15-2	15	2½ x 2 x 6 <sup>9</sup> / <sub>16</sub>	2½	4 <sup>9</sup> / <sub>16</sub>	5 <sup>11</sup> / <sub>16</sub>	7 <sup>5</sup> / <sub>16</sub>	1 <sup>1</sup> / <sub>16</sub>	2	3 <sup>3</sup> / <sub>4</sub>	4 <sup>15</sup> / <sub>16</sub>	6½	1 <sup>1</sup> / <sub>16</sub>	

MODEL	PUMP											
	A	E	H	H1	H2	N1	N2	P	b	f	Max. F	
PS1¼-1-4	-	-	-	-	-	-	-	7 <sup>9</sup> / <sub>16</sub>	5	3½	19 <sup>13</sup> / <sub>16</sub>	
PS1¼-1.5-4	-	-	-	-	-	-	-	7 <sup>9</sup> / <sub>16</sub>	5	3½	19 <sup>5</sup> / <sub>8</sub>	
PS1¼-3-2	3 <sup>1</sup> / <sub>8</sub>	8 <sup>3</sup> / <sub>8</sub>	9 <sup>15</sup> / <sub>16</sub>	4 <sup>7</sup> / <sub>16</sub>	5½	5½	7½	7 <sup>3</sup> / <sub>16</sub>	4½	4½	19 <sup>3</sup> / <sub>16</sub>	
PS1¼-5-2	3 <sup>1</sup> / <sub>8</sub>	10	11½	5 <sup>3</sup> / <sub>16</sub>	6 <sup>5</sup> / <sub>16</sub>	7½	9 <sup>7</sup> / <sub>16</sub>	7 <sup>3</sup> / <sub>16</sub>	5½	4½	20 <sup>5</sup> / <sub>8</sub>	
PS1¼-7.5-2	3 <sup>1</sup> / <sub>8</sub>	11 <sup>9</sup> / <sub>16</sub>	13 <sup>3</sup> / <sub>8</sub>	6 <sup>5</sup> / <sub>16</sub>	7 <sup>1</sup> / <sub>16</sub>	7½	9 <sup>7</sup> / <sub>16</sub>	8 <sup>3</sup> / <sub>16</sub>	5½	5¼	20 <sup>3</sup> / <sub>4</sub>	
PS1¼-10-2	3 <sup>1</sup> / <sub>8</sub>	11 <sup>9</sup> / <sub>16</sub>	13 <sup>3</sup> / <sub>8</sub>	6 <sup>5</sup> / <sub>16</sub>	7 <sup>1</sup> / <sub>16</sub>	7½	9 <sup>7</sup> / <sub>16</sub>	8 <sup>3</sup> / <sub>16</sub>	5½	5¼	21 <sup>7</sup> / <sub>8</sub>	
PS1½-5-2	3 <sup>1</sup> / <sub>8</sub>	8 <sup>3</sup> / <sub>8</sub>	9 <sup>15</sup> / <sub>16</sub>	4 <sup>7</sup> / <sub>16</sub>	5½	6 <sup>3</sup> / <sub>16</sub>	8¼	7 <sup>3</sup> / <sub>16</sub>	5½	4½	20 <sup>3</sup> / <sub>4</sub>	
PS1½-7.5-2	3 <sup>1</sup> / <sub>8</sub>	10	11½	5 <sup>3</sup> / <sub>16</sub>	6 <sup>5</sup> / <sub>16</sub>	7½	9 <sup>7</sup> / <sub>16</sub>	8 <sup>3</sup> / <sub>16</sub>	5½	5¼	20 <sup>3</sup> / <sub>4</sub>	
PS1½-10-2	3 <sup>1</sup> / <sub>8</sub>	10	11½	5 <sup>3</sup> / <sub>16</sub>	6 <sup>5</sup> / <sub>16</sub>	7½	9 <sup>7</sup> / <sub>16</sub>	8 <sup>3</sup> / <sub>16</sub>	7	5¼	21 <sup>7</sup> / <sub>8</sub>	
PS1½-15-2	3 <sup>15</sup> / <sub>16</sub>	11 <sup>9</sup> / <sub>16</sub>	13 <sup>3</sup> / <sub>8</sub>	6 <sup>5</sup> / <sub>16</sub>	7 <sup>1</sup> / <sub>16</sub>	8 <sup>3</sup> / <sub>8</sub>	10 <sup>7</sup> / <sub>16</sub>	8 <sup>3</sup> / <sub>16</sub>	7	5¼	22 <sup>11</sup> / <sub>16</sub>	
PS2-2-4	-	-	-	-	-	-	-	7 <sup>3</sup> / <sub>8</sub>	5	3½	19 <sup>5</sup> / <sub>8</sub>	
PS2-7.5-2	3 <sup>15</sup> / <sub>16</sub>	10	11½	5 <sup>3</sup> / <sub>16</sub>	6 <sup>5</sup> / <sub>16</sub>	7½	9 <sup>7</sup> / <sub>16</sub>	8 <sup>3</sup> / <sub>16</sub>	5½	5¼	21 <sup>9</sup> / <sub>16</sub>	
PS2-10-2	3 <sup>15</sup> / <sub>16</sub>	11 <sup>11</sup> / <sub>16</sub>	13 <sup>3</sup> / <sub>8</sub>	6 <sup>5</sup> / <sub>16</sub>	7 <sup>1</sup> / <sub>16</sub>	8 <sup>3</sup> / <sub>8</sub>	10 <sup>7</sup> / <sub>16</sub>	8 <sup>3</sup> / <sub>16</sub>	5½	5¼	21 <sup>9</sup> / <sub>16</sub>	
PS2-15-2	3 <sup>15</sup> / <sub>16</sub>	11 <sup>11</sup> / <sub>16</sub>	13 <sup>3</sup> / <sub>8</sub>	6 <sup>5</sup> / <sub>16</sub>	7 <sup>1</sup> / <sub>16</sub>	8 <sup>3</sup> / <sub>8</sub>	10 <sup>7</sup> / <sub>16</sub>	8 <sup>3</sup> / <sub>16</sub>	7	5¼	22 <sup>11</sup> / <sub>16</sub>	

Dimensions in inches.

**IMPORTANT!**

1. Never use this pump to handle explosive liquids.
2. This pump is not approved to be used in swimming pools, recreational installations or any application where human contact may be common.

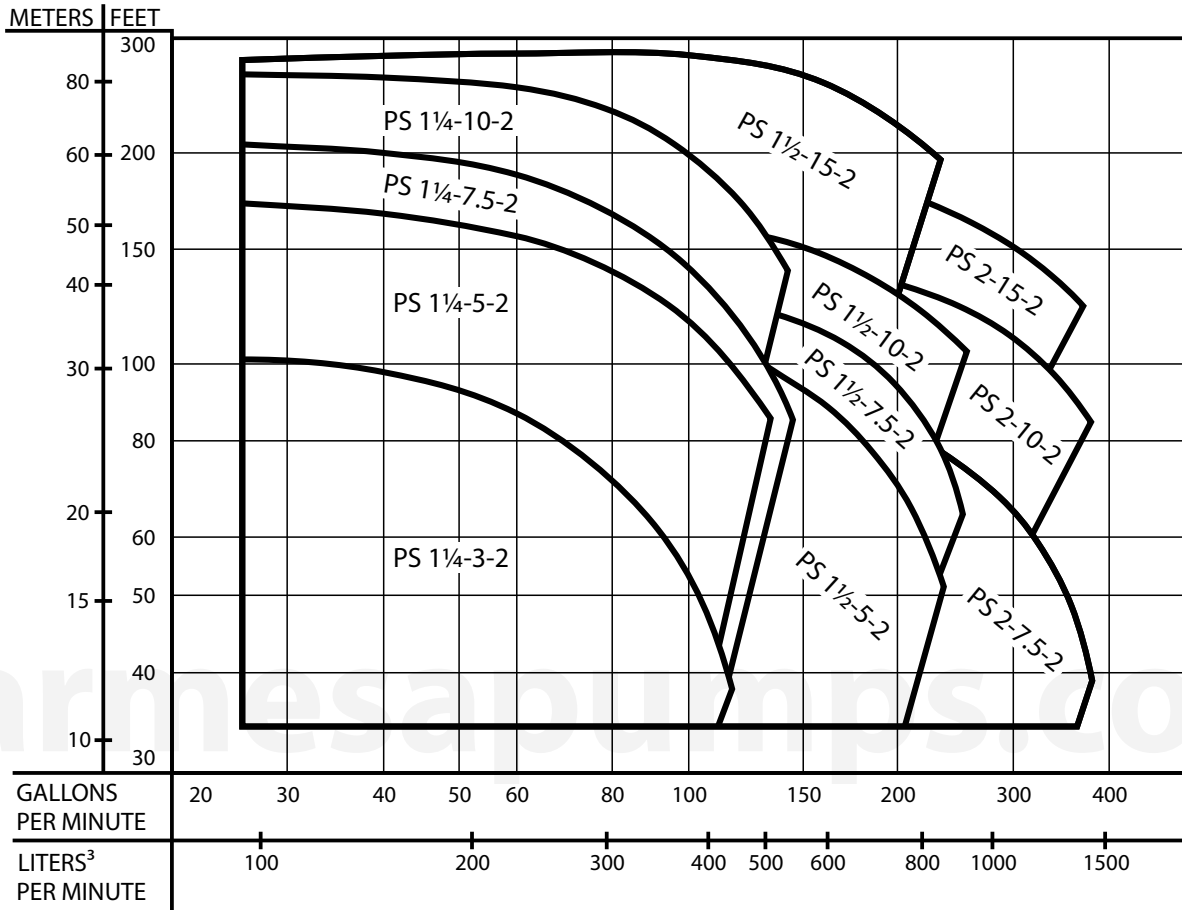

MODEL	SIZE		HP	B.E.P.
	SUCTION	DISCHARGE		
PS 1 1/4-3-2	2"	1 1/4"	3	85 GPM @ 73 FEET
PS 1 1/4-5-2	2"	1 1/4"	5	100 GPM @ 125 FEET
PS 1 1/4-7.5-2	2"	1 1/4"	7.5	90 GPM @ 154 FEET
PS 1 1/4-10-2	2"	1 1/4"	10	110 GPM @ 183 FEET
PS 1 1/2-5-2	2 1/2"	1 1/2"	5	170 GPM @ 88 FEET
PS 1 1/2-7.5-2	2 1/2"	1 1/2"	7.5	160 GPM @ 113 FEET
PS 1 1/2-10-2	2 1/2"	1 1/2"	10	180 GPM @ 139 FEET
PS 1 1/2-15-2	2 1/2"	1 1/2"	15	190 GPM @ 235 FEET
PS 2-7.5-2	2 1/2"	2"	7.5	240 GPM @ 76 FEET
PS 2-10-2	2 1/2"	2"	10	250 GPM @ 124 FEET
PS 2-15-2	2 1/2"	2"	15	280 GPM @ 155 FEET

B.E.P. = Best Efficiency Point

Testing is performed with water specific gravity of 1.0 @ 68° F (20° C); other fluids may vary performance.

MODEL: PS 1¼-3-2, 3 HP

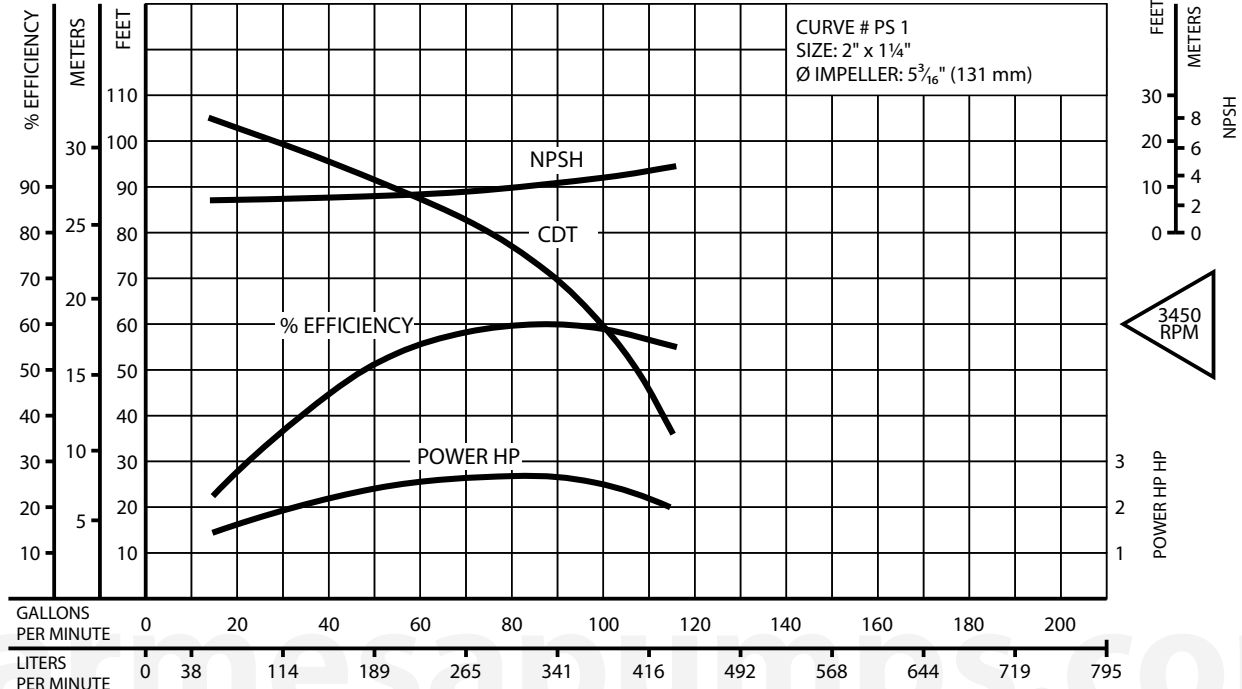

MODEL: PS 1¼-5-2, 5 HP

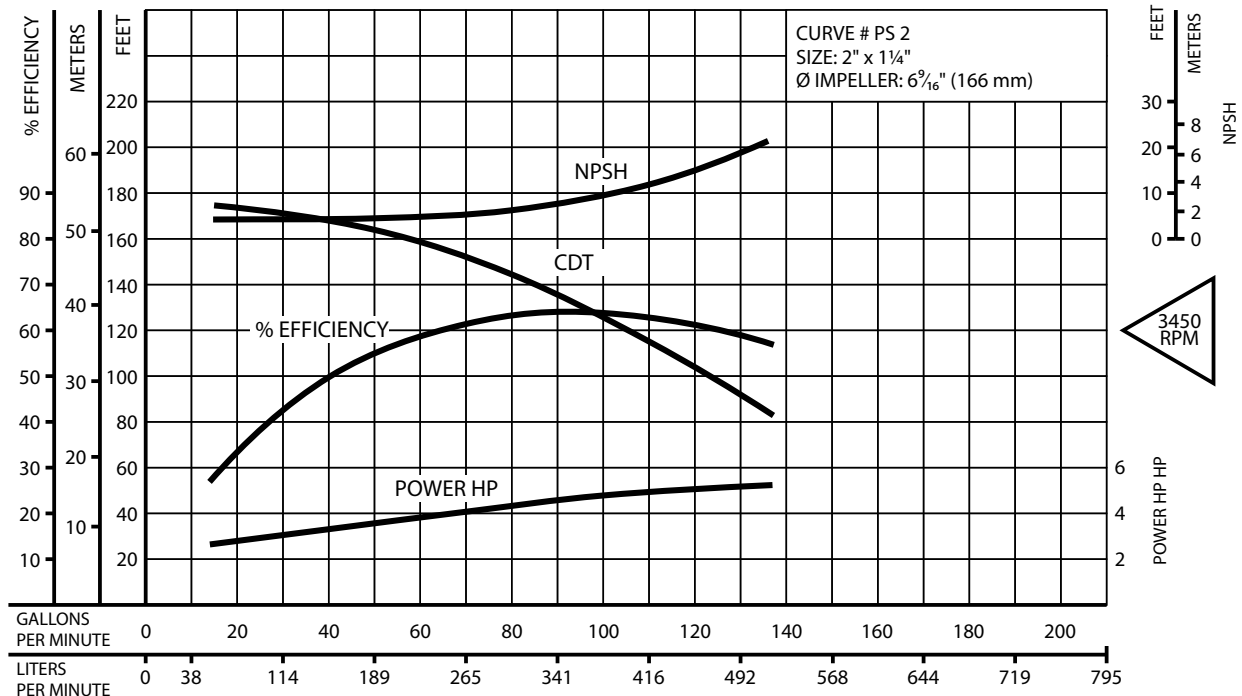

Testing is performed with water specific gravity of 1.0 @ 68° F (20° C); other fluids may vary performance.

MODEL: PS 1¼-7.5-2, 7.5 HP

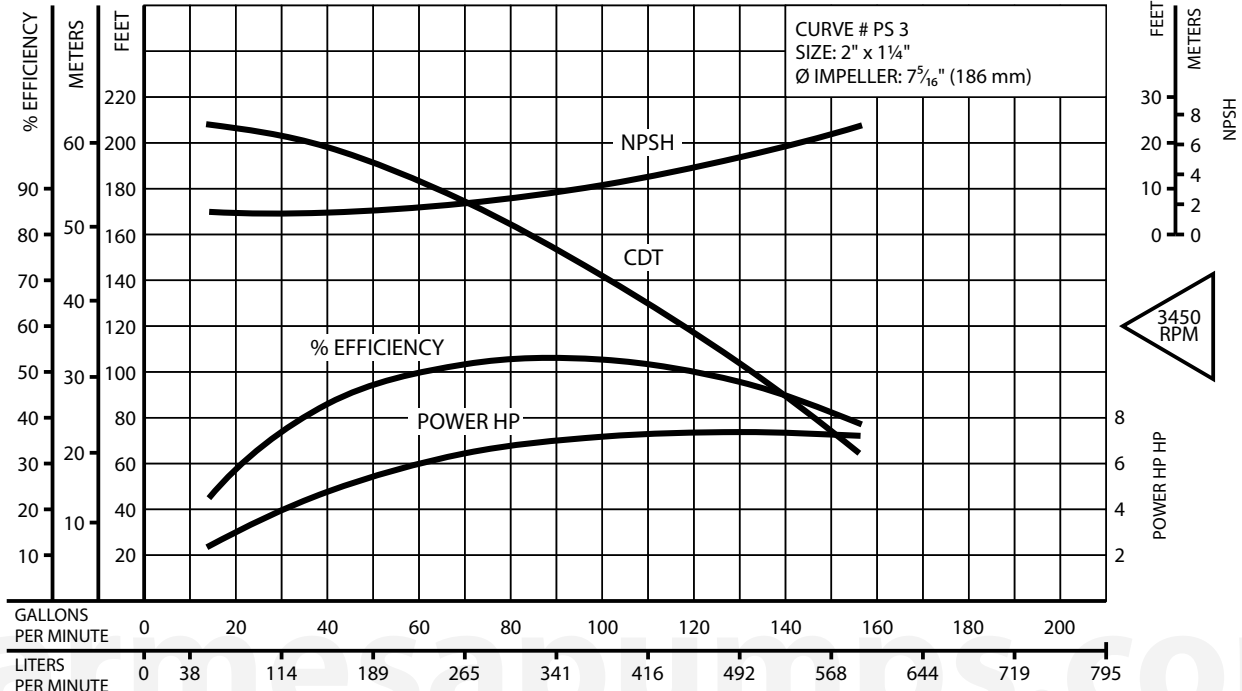

MODEL: PS 1¼-10-2, 10 HP

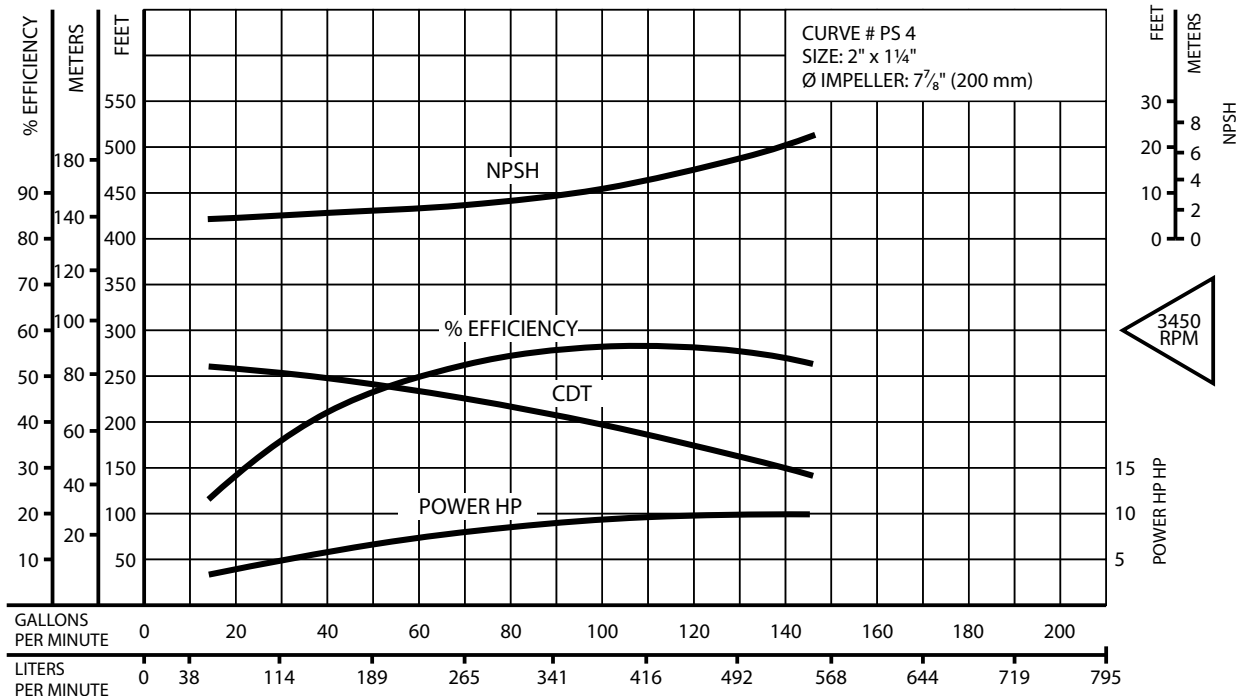

Testing is performed with water specific gravity of 1.0 @ 68° F (20° C); other fluids may vary performance.

MODEL: PS 1½-5-2, 5 HP

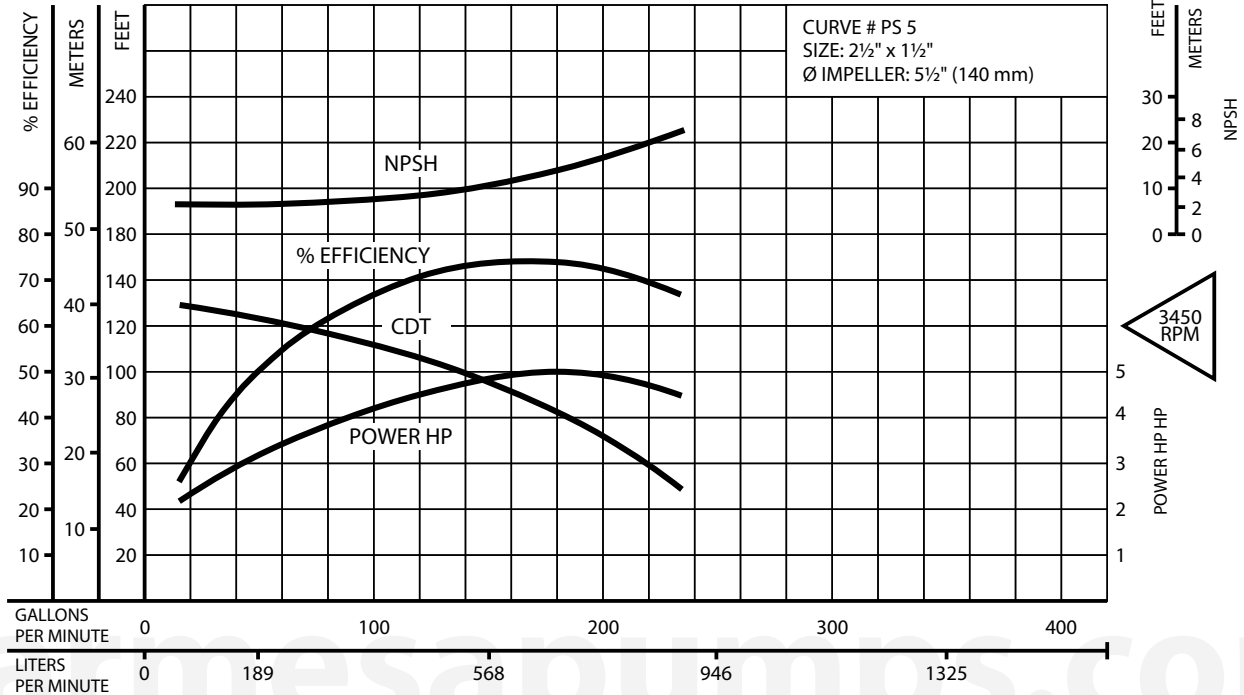

MODEL: PS 1½-7.5-2, 7.5 HP

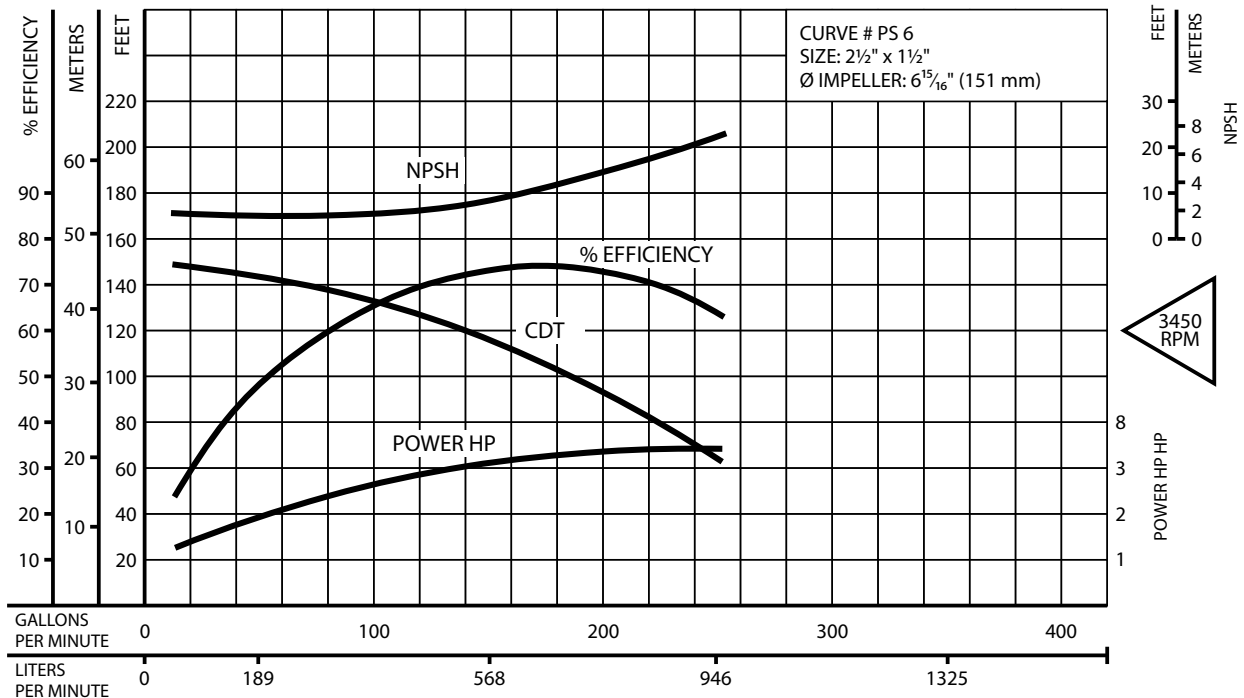

Testing is performed with water specific gravity of 1.0 @ 68° F (20° C); other fluids may vary performance.

MODEL: PS 1½-10-2, 10 HP

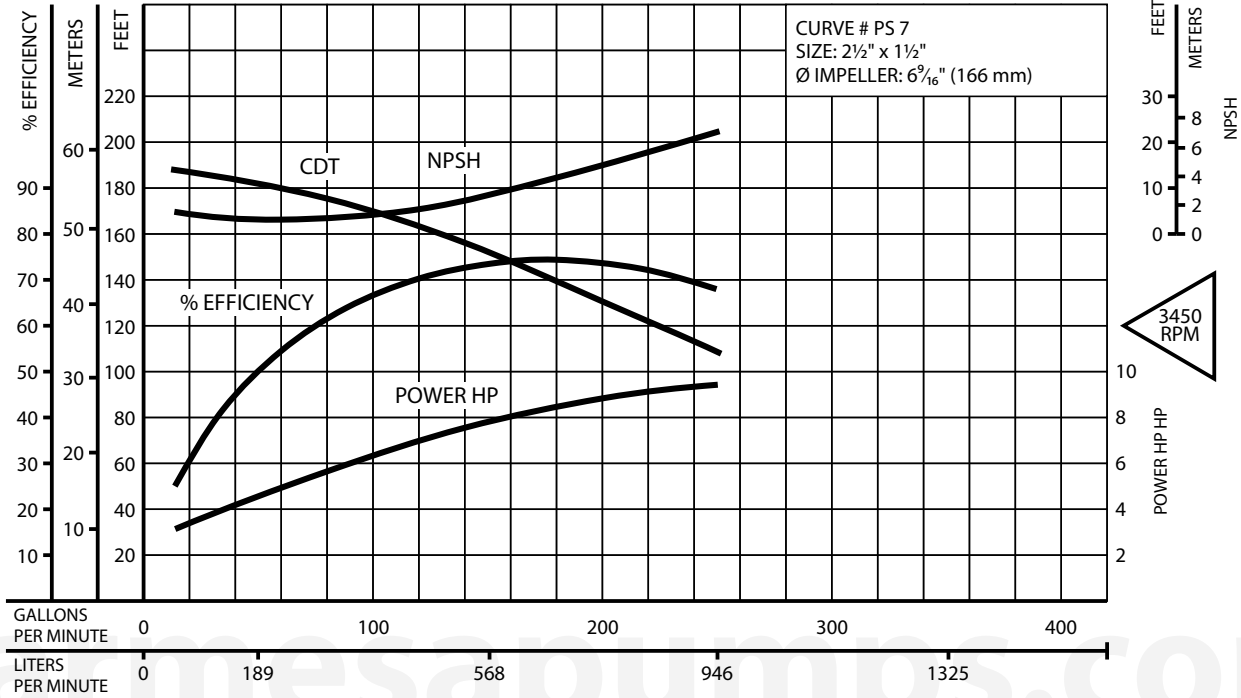

MODEL: PS 1½-15-2, 3 HP

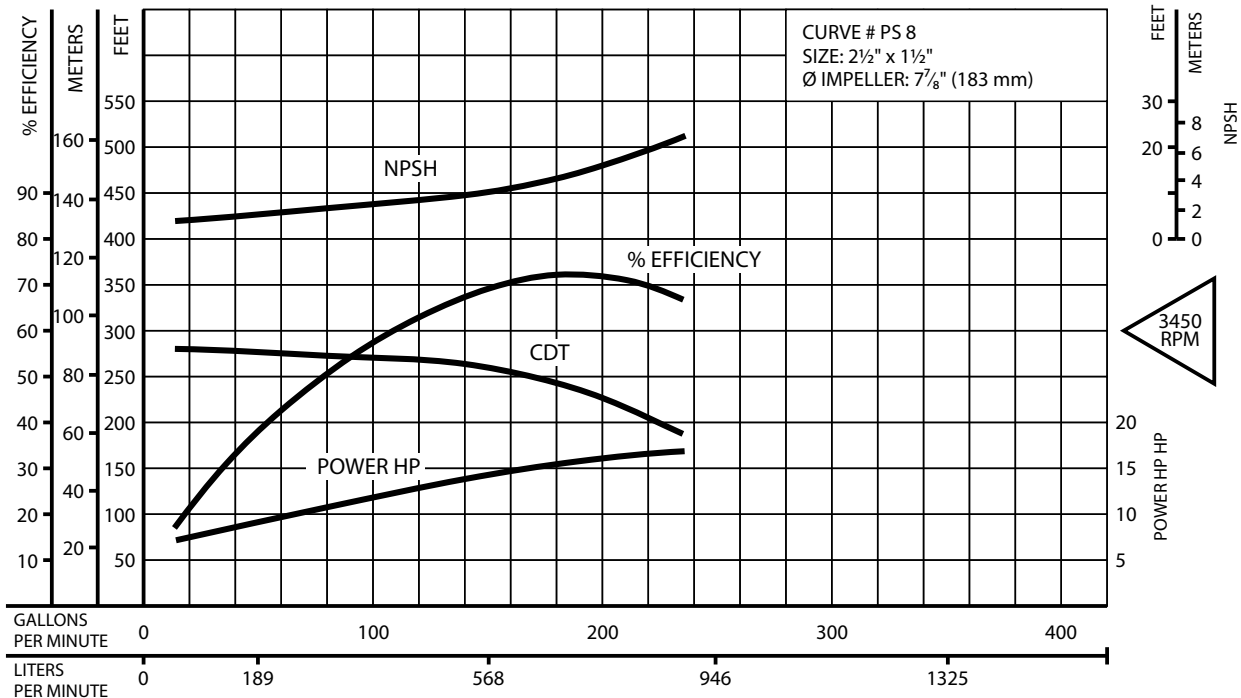

Testing is performed with water specific gravity of 1.0 @ 68° F (20° C); other fluids may vary performance.

MODEL: PS 2-7.5-2, 7.5 HP

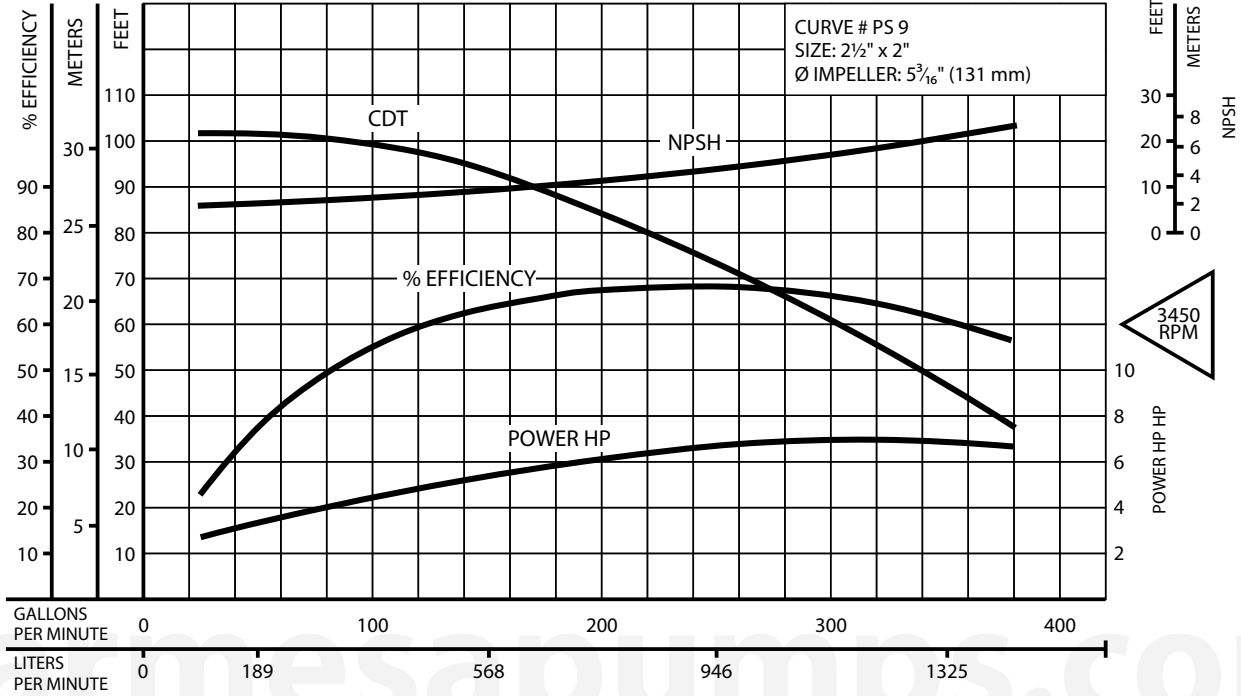

MODEL: PS 2-10-2, 10 HP

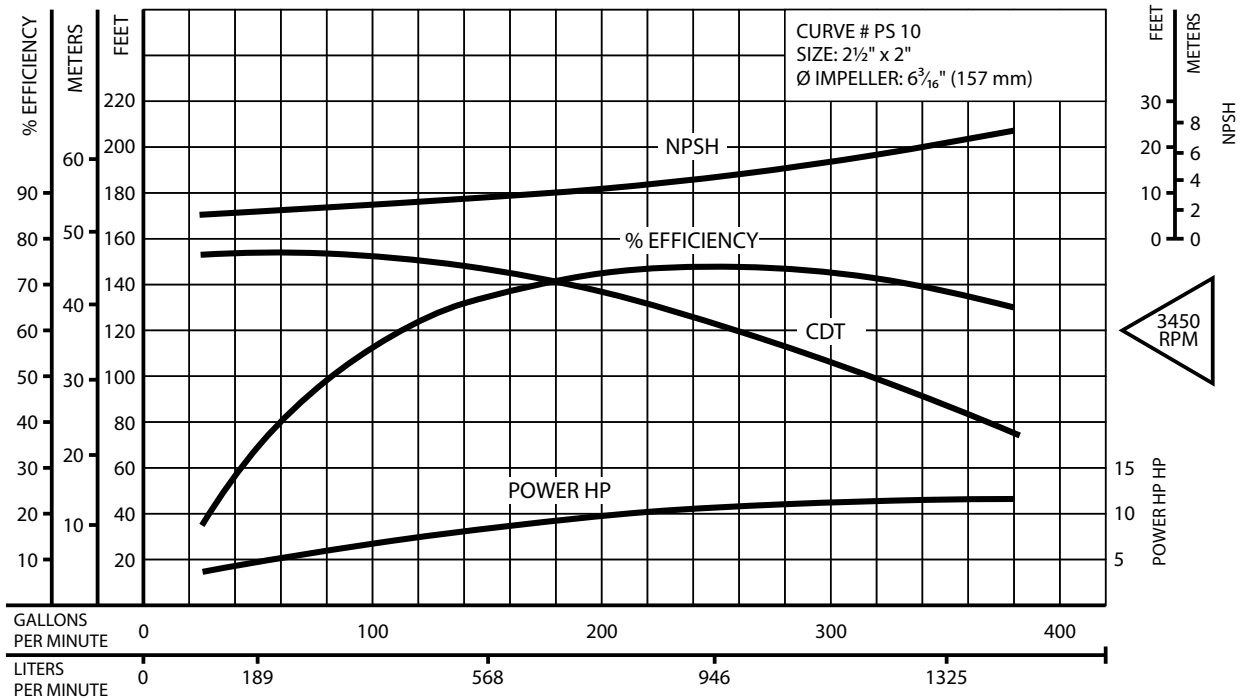

Testing is performed with water specific gravity of 1.0 @ 68° F (20° C); other fluids may vary performance.



MODEL: PS 2-15-2, 15 HP

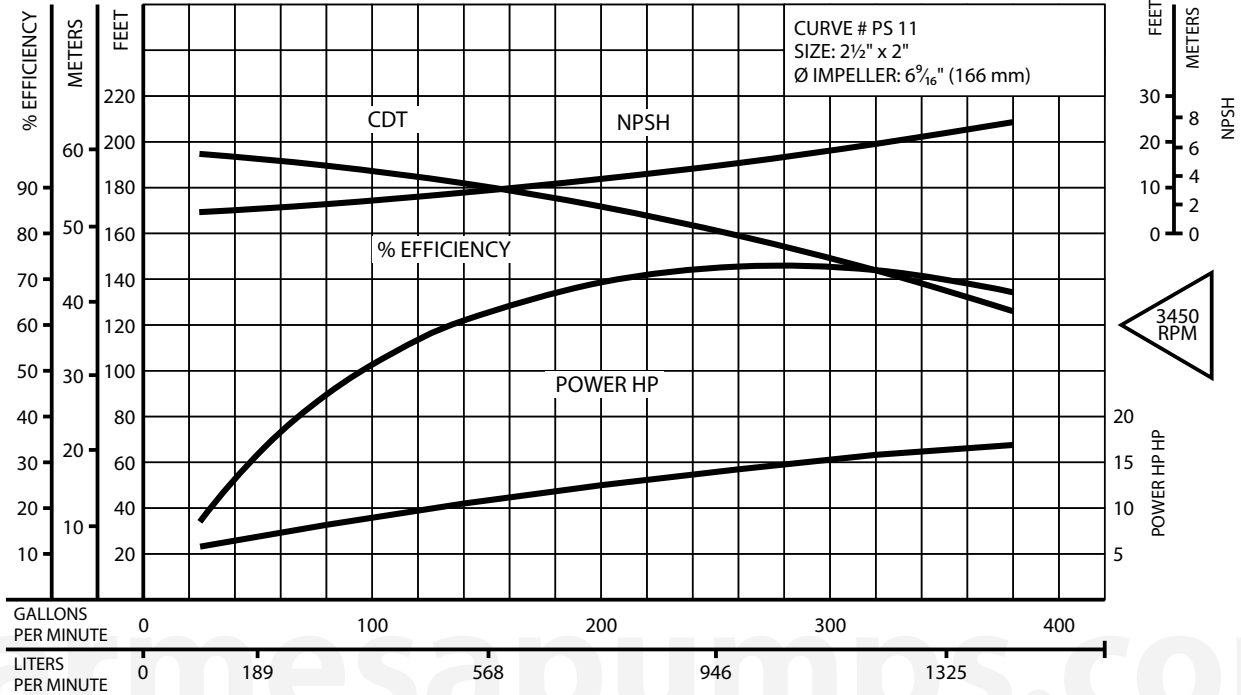

MODEL: PS 1¼-1-4, 1 HP

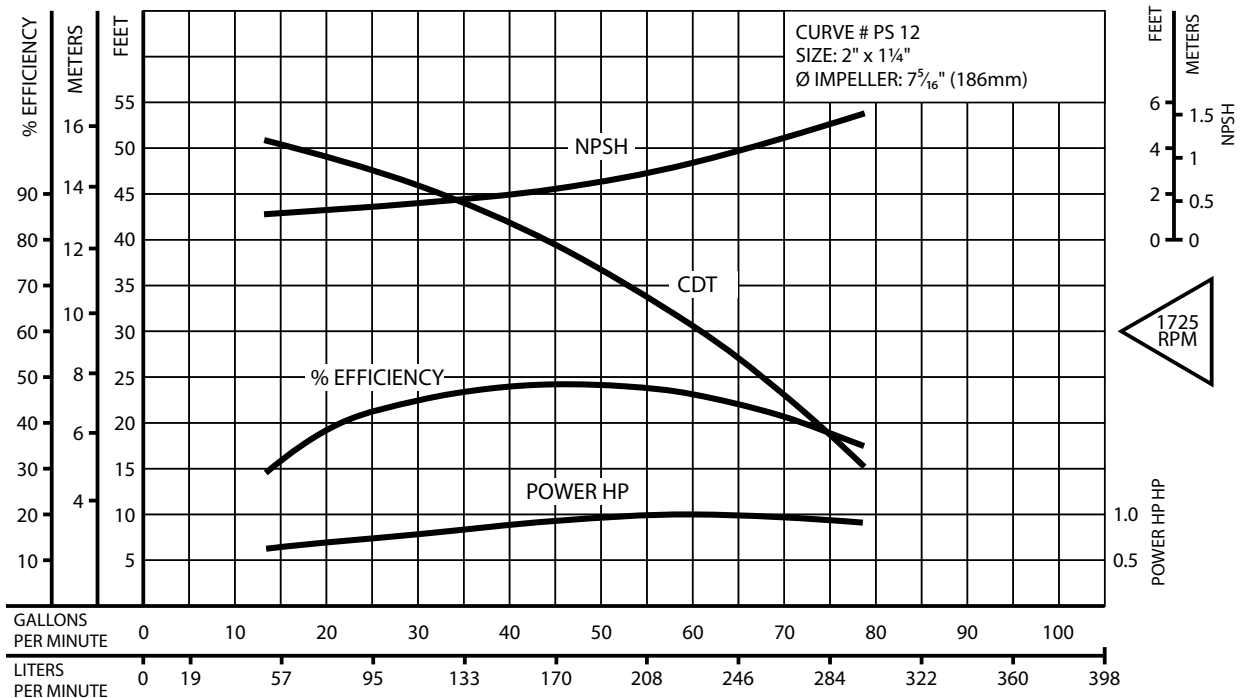

Testing is performed with water specific gravity of 1.0 @ 68° F (20° C); other fluids may vary performance.

MODEL: PS 1¼-1.5-4, 1.5 HP

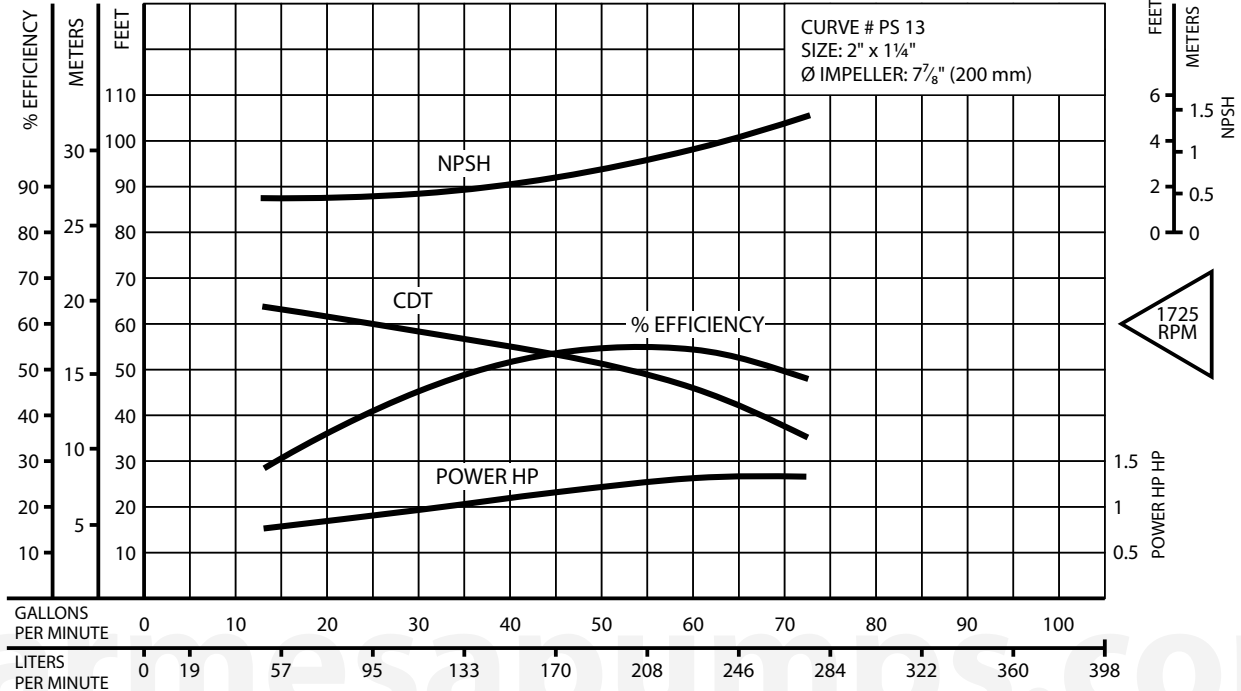

MODEL: PS 2-2-4, 2 HP

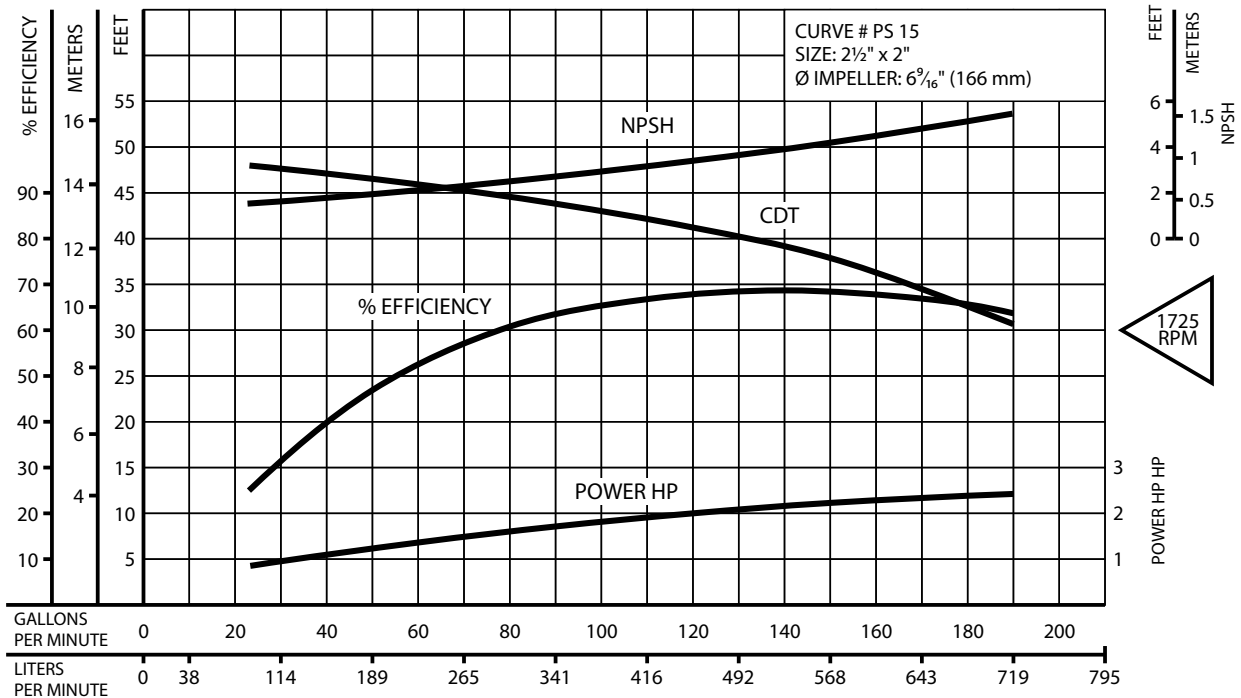

Testing is performed with water specific gravity of 1.0 @ 68° F (20° C); other fluids may vary performance.