

SUBMERSIBLE SOLIDS HANDLING X-PROOF PUMP

Series: 8XBSE30046HADS
30 HP / 1150 RPM
Discharge: 8"
Spherical solids handling: 3"



Representative image.

DISCHARGE

8", 125 lb, flange horizontal.

LIQUID TEMPERATURE

104°F (40 °C).

VOLUTE

Cast iron ASTM A-48 class 30.

MOTOR HOUSING

N/A

SEAL PLATE

Cast iron ASTM A-48 class 30.

IMPELLER

Design: 3 vanes, closed, with a bronze wear ring and vanes on back side.

Material: cast iron ASTM A-48 class 30.

SHAFT

416 series stainless steel.

SQUARE RINGS

Square shaped Buna-N.

PAINT

Air dry enamel, water based.

DIAPHRAGM

Buna-N.

HARDWARE

300 series stainless steel.

SEAL

Design: double, mechanical, oil filled chamber.

Material: ceramic stationary seat, carbon ring and exclusion seal in the rotatory set, Buna-N elastomer and stainless steel hardware.

CORD ENTRY

25 ft of neoprene cord, sealed against moisture.

BEARINGS

Upper: single row, ball, permanently oil lubricated, designed for radial load.

Lower: double row, ball, permanently oil lubricated, designed for radial and axial loads.

MOTOR

Explosion proof, NEMA B, three phase, 460 volts, 60 Hz, 1150 RPM, air cooled. Requires overload protection to be included in control panel.

MOISTURE SENSOR

Normally open (N/O) included.

TEMPERATURE SENSOR

Normally closed (N/C) included.

OPTIONAL EQUIPMENT

Impeller trimming, additional cord, tungsten carbide seal, slide rail coupling (SRC-8).

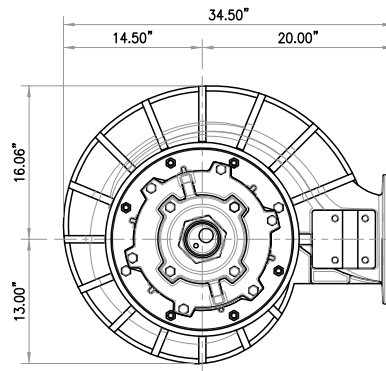
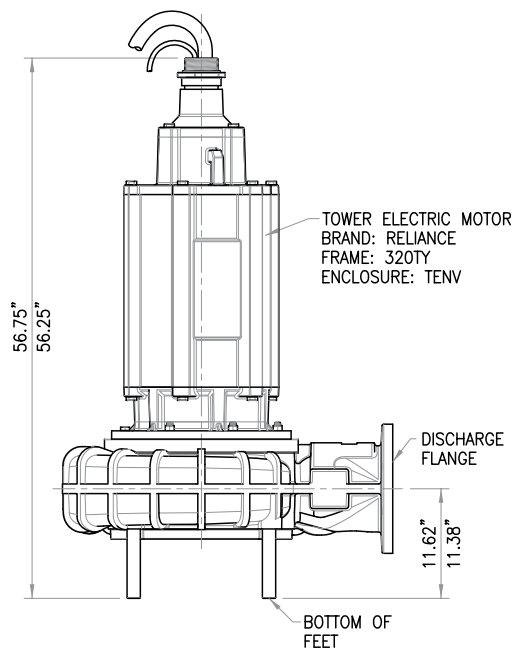

DISCHARGE FLANGE

BRANCH:	8"
RATING:	150 PSI
O.D.:	13.50"
BOLTS:	8
BOLTS SIZE:	.750"
BCD:	11.75"
THICK:	1.19"

DIMENSIONS IN INCHES

MODEL	PART No.	HP	VOLTS	PHASE	RPM (Nominal)	MAX AMPS	LOCKED ROTOR AMPS	NEMA CODE	CORD SIZE	CORD TYPE	CORD O.D.	WEIGHT (pounds)
8XBSE30046HADS	62170361	30	460	3	1150	40	210	G	8/4	SOW	0.985"	1700

The moisture cord and/or temperature cord is size 18/5, type SO, Ø0.485".

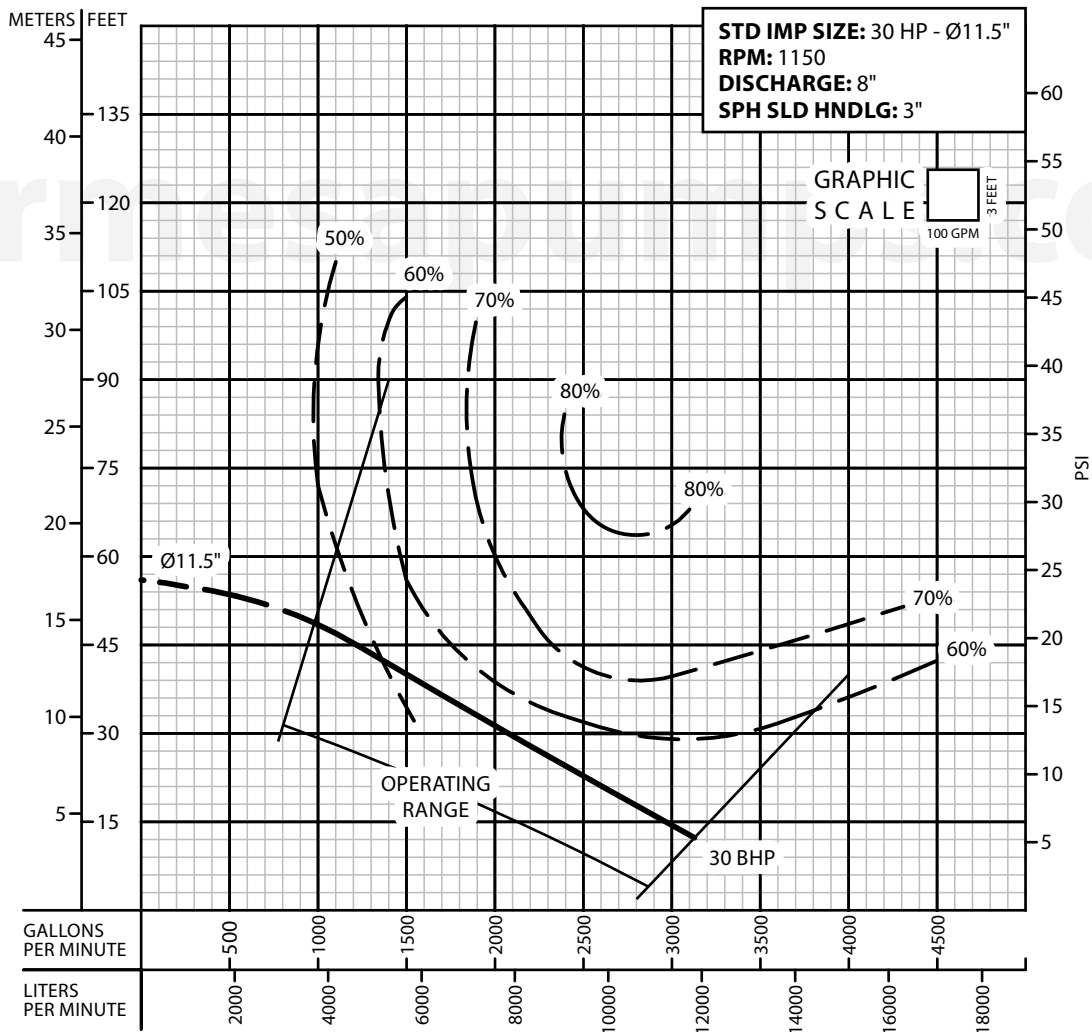

IMPORTANT!

1. Never use this pump to handle explosive liquids.
2. This pump is not approved to be used in swimming pools, recreational installations or any application where human contact may be common.
3. Pump may be operated "dry" for extended periods without damage to motor and/or seals.