

# ZP3 Series Positive Displacement Pumps

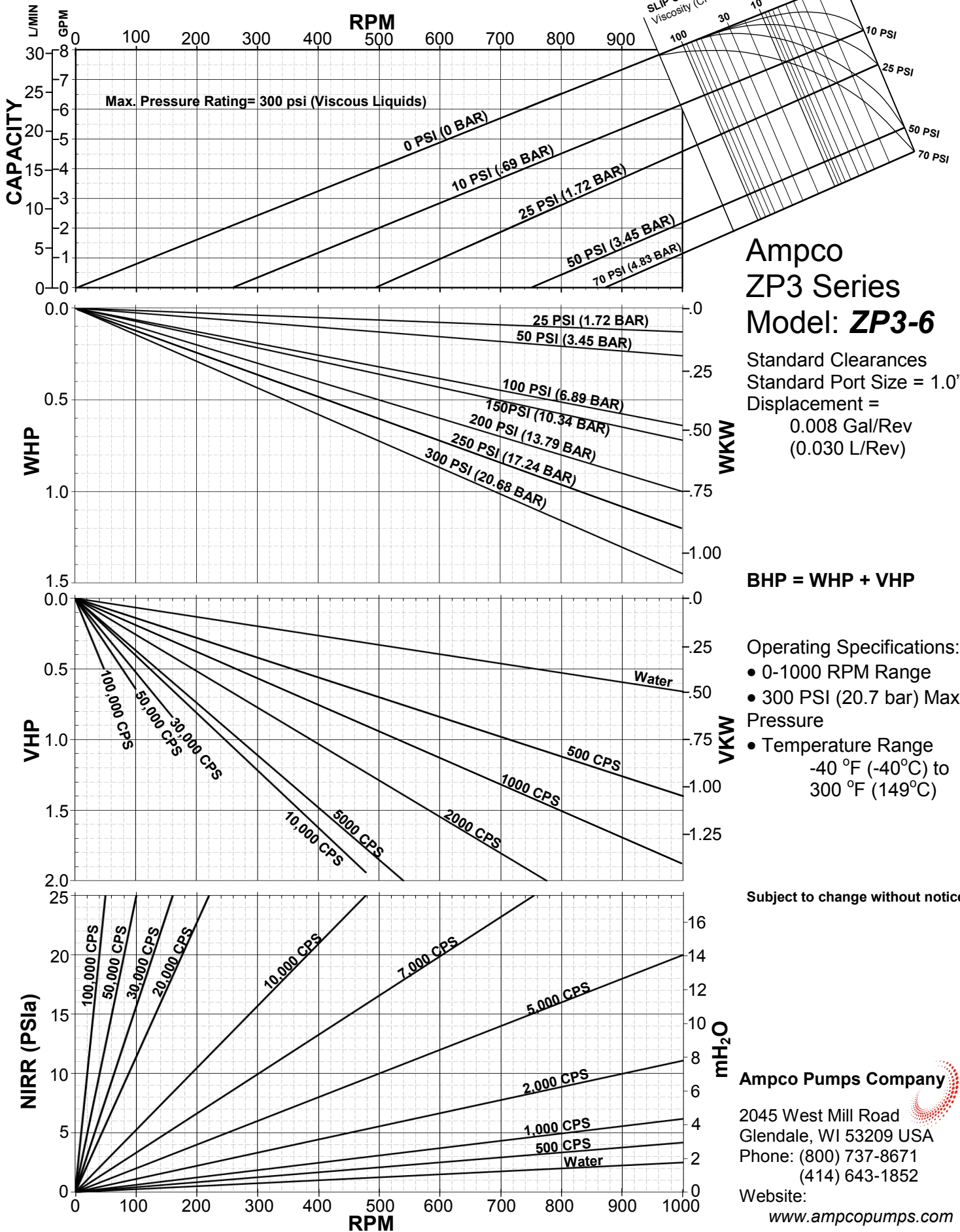

## Ampco ZP3 Series Model: **ZP3-6**

Standard Clearances  
Standard Port Size = 1.0"  
Displacement =  
0.008 Gal/Rev  
(0.030 L/Rev)

**BHP = WHP + VHP**

- Operating Specifications:
- 0-1000 RPM Range
  - 300 PSI (20.7 bar) Max. Pressure
  - Temperature Range  
-40 °F (-40°C) to  
300 °F (149°C)

Subject to change without notice

**Ampco Pumps Company**

2045 West Mill Road  
Glendale, WI 53209 USA  
Phone: (800) 737-8671  
(414) 643-1852

Website:  
[www.ampcopumps.com](http://www.ampcopumps.com)

# ZP3 Series Positive Displacement Pumps

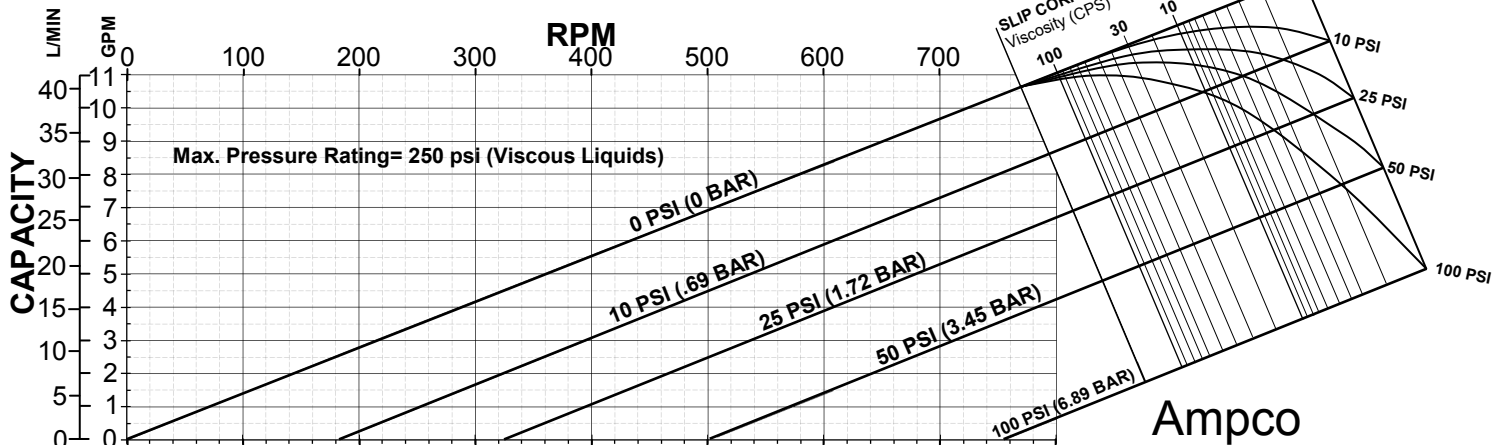

## Ampco ZP3 Series Model: **ZP3-15**

Standard Clearances  
Standard Port Size = 1.5"  
Displacement =  
0.014 Gal/Rev  
(0.054 L/Rev)

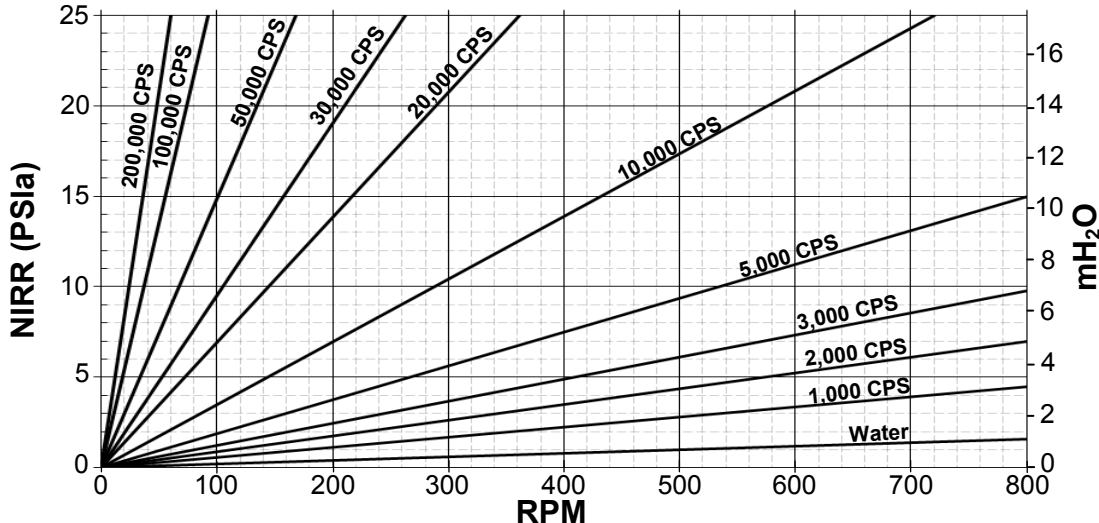
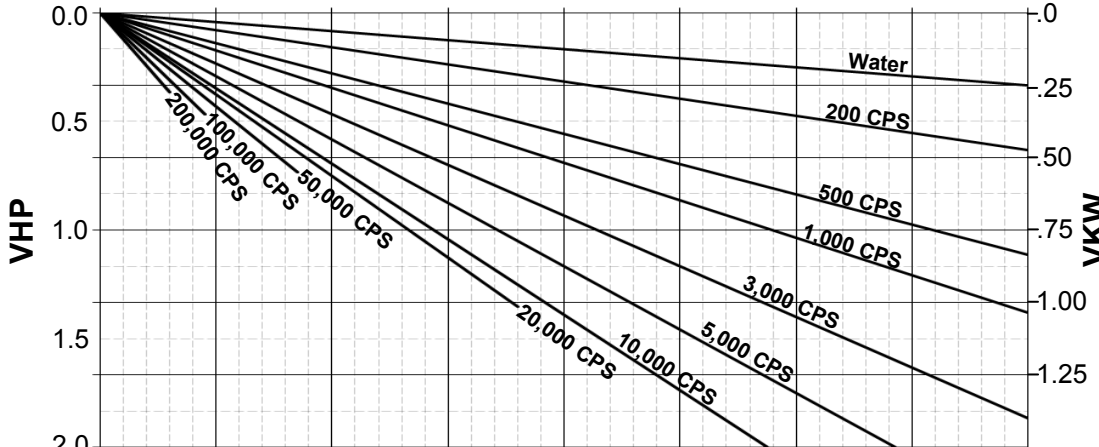
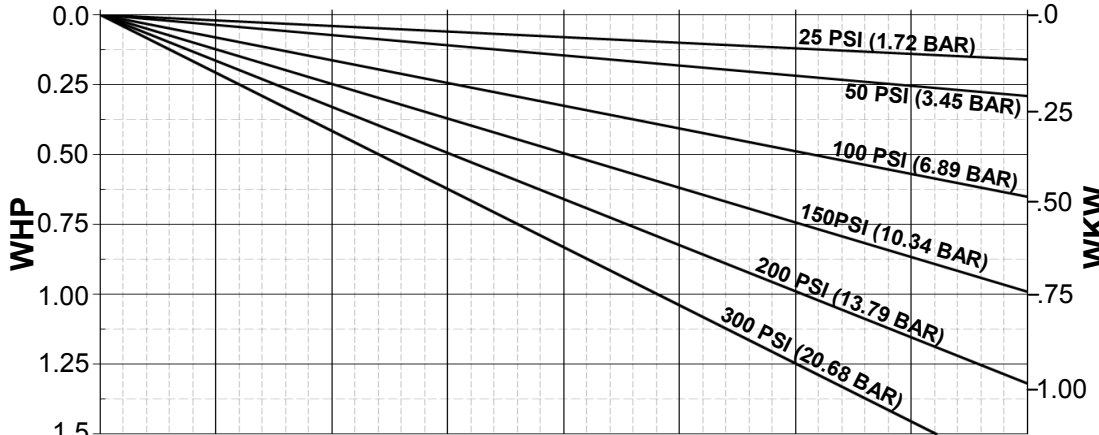

**BHP = WHP + VHP**

- Operating Specifications:
- 0-800 RPM Range
  - 250 PSI (17.2 bar) Max. Pressure
  - Temperature Range  
-40 °F (-40°C) to  
300 °F (149°C)

Subject to change without notice

**Ampco Pumps Company**

2045 West Mill Road  
Glendale, WI 53209 USA  
Phone: (800) 737-8671  
(414) 643-1852

Website:  
[www.ampcopumps.com](http://www.ampcopumps.com)

# ZP3 Series Positive Displacement Pumps

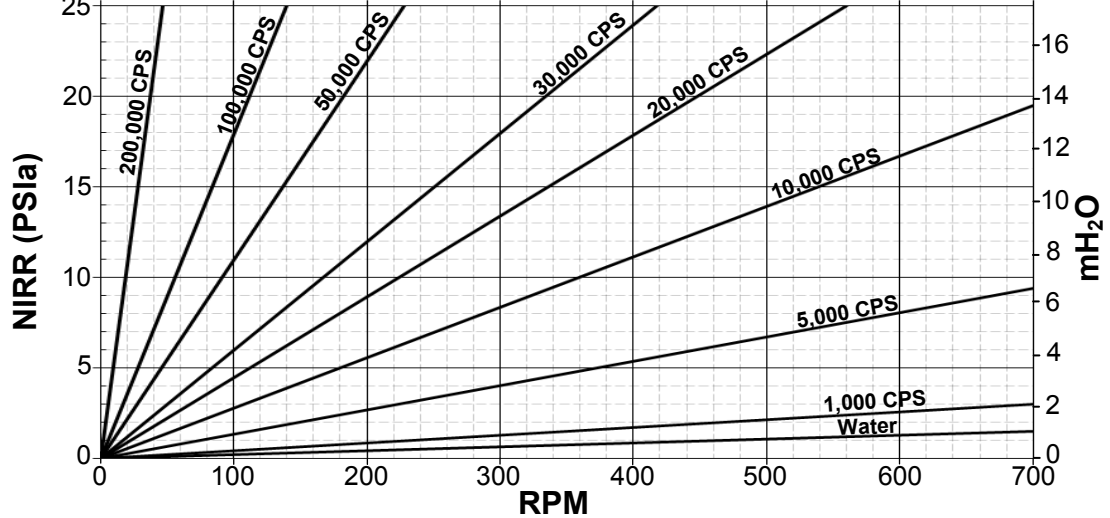
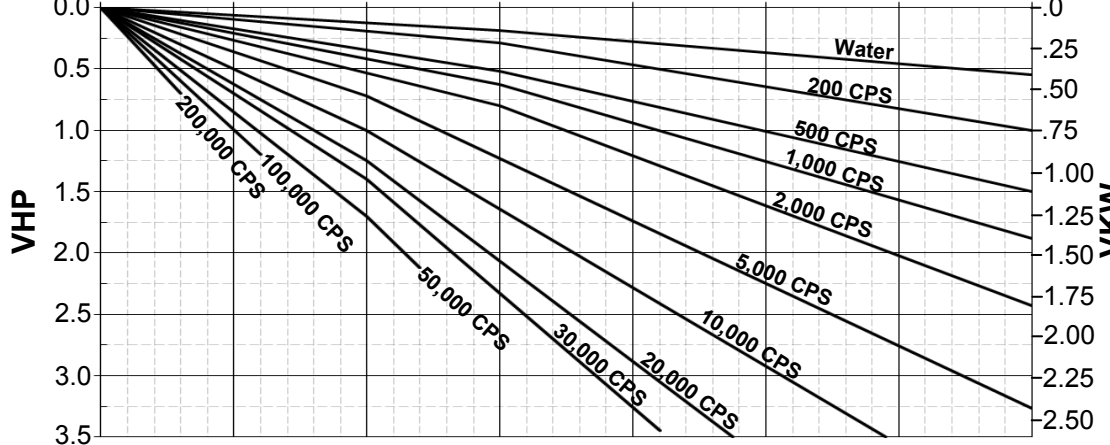
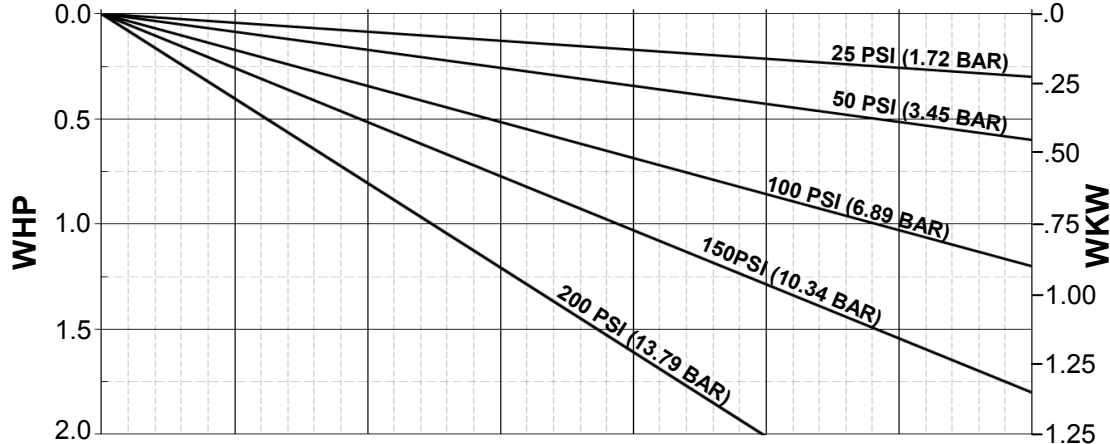
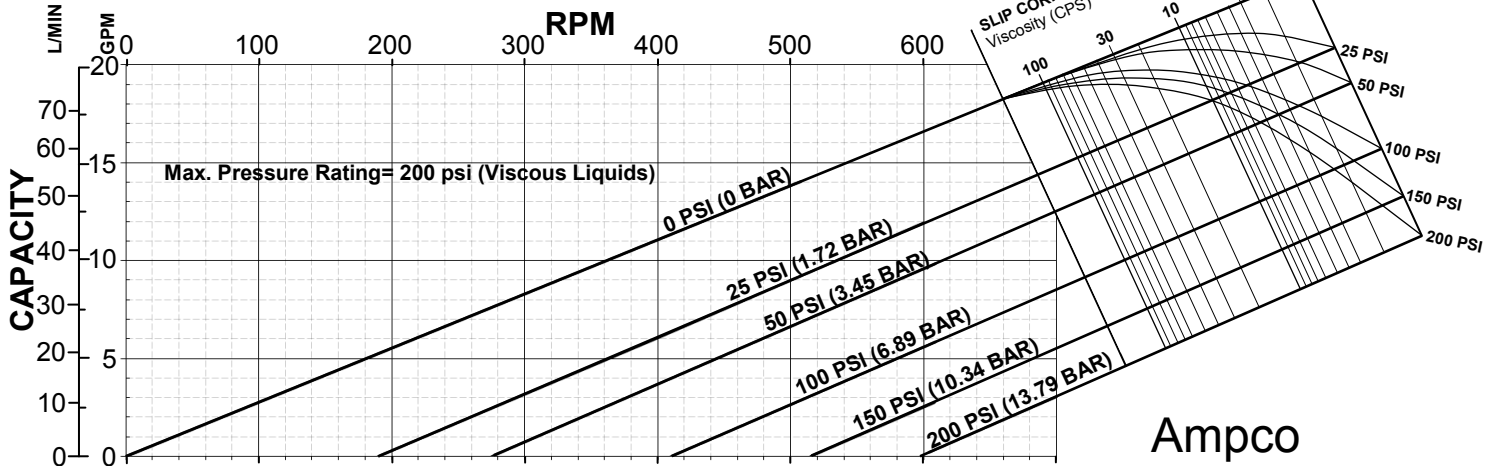

**Ampco**  
**ZP3 Series**  
**Model: ZP3-18**  
 Standard Clearances  
 Standard Port Size = 1.5"  
 Displacement =  
 0.029 Gal/Rev  
 (0.108 L/Rev)

**BHP = WHP + VHP**

- Operating Specifications:
- 0-700 RPM Range
  - 200 PSI (13.8 bar) Max. Pressure
  - Temperature Range  
 -40 °F (-40°C) to  
 300 °F (149°C)

Subject to change without notice

**Ampco Pumps Company**  
 2045 West Mill Road  
 Glendale, WI 53209 USA  
 Phone: (800) 737-8671  
 (414) 643-1852  
 Website:  
[www.ampcopumps.com](http://www.ampcopumps.com)

# ZP3 Series Positive Displacement Pumps

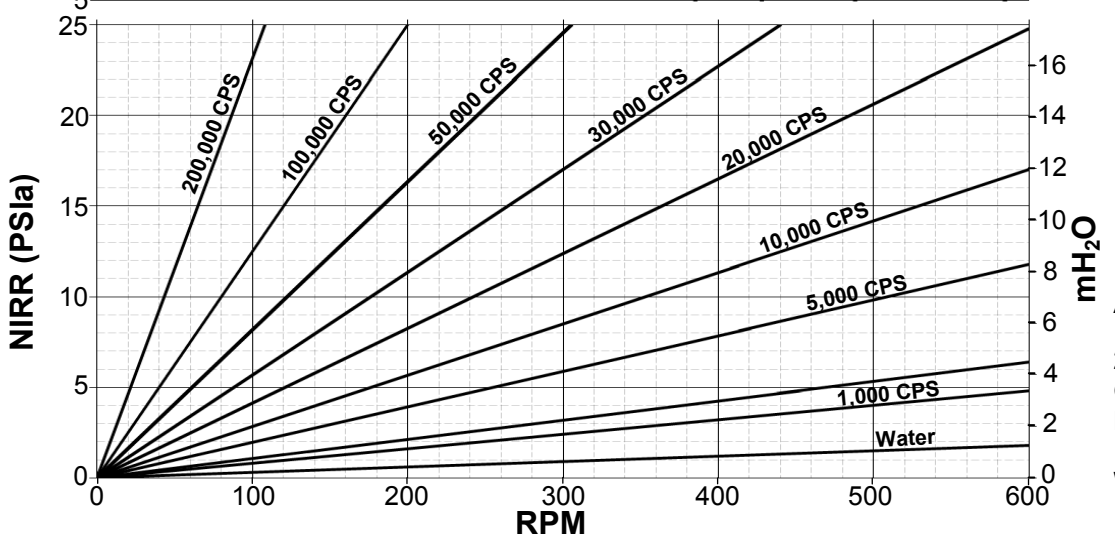
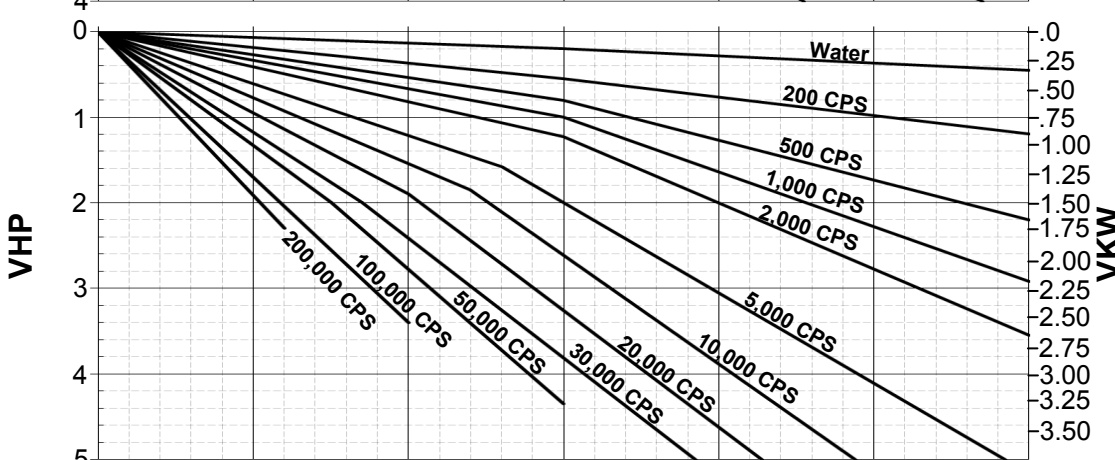
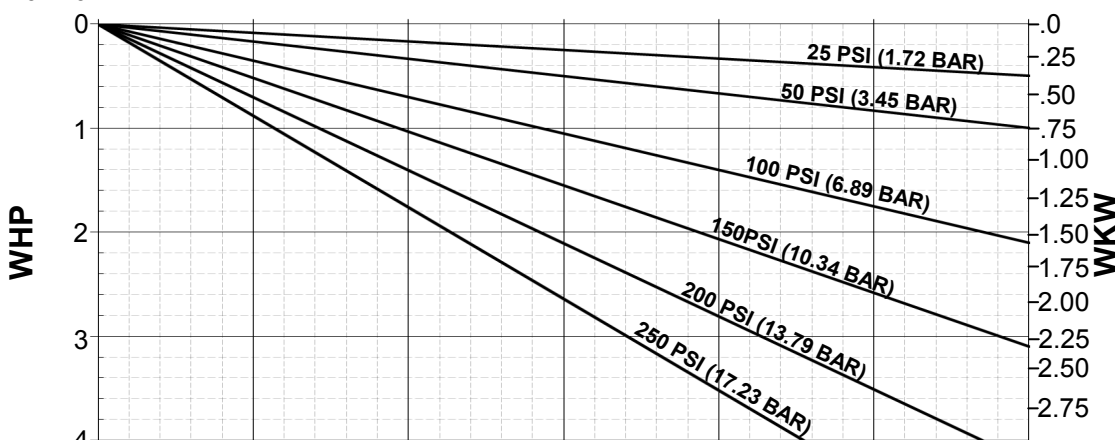
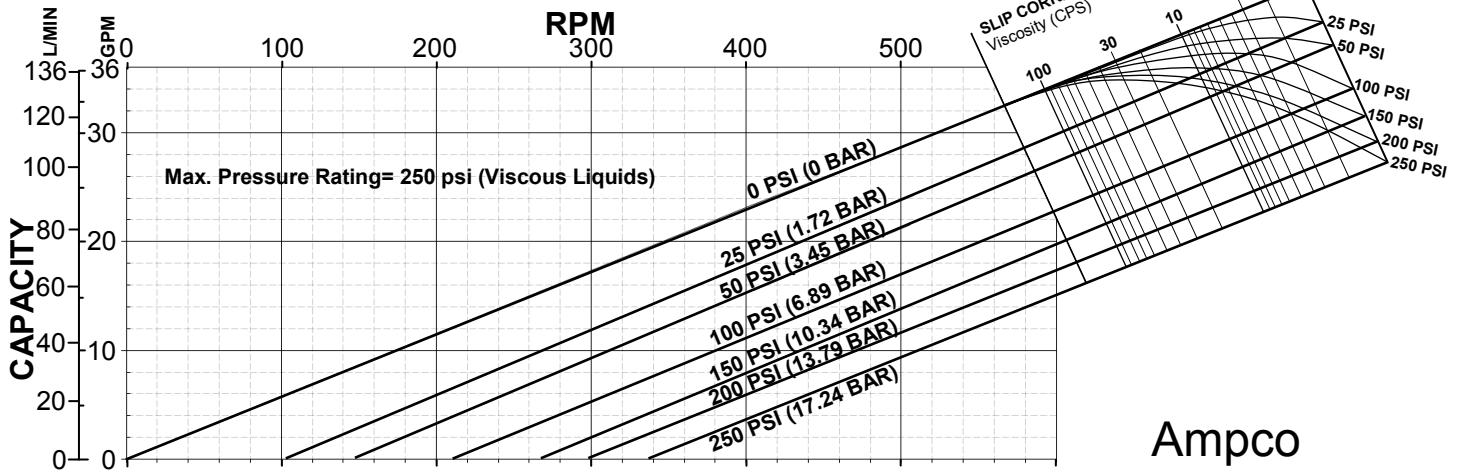

## Ampco ZP3 Series Model: **ZP3-30**

Standard Clearances  
Standard Port Size = 1.5"  
Displacement =  
0.060 Gal/Rev  
(0.227 L/Rev)

**BHP = WHP + VHP**

- Operating Specifications:
- 0-600 RPM Range
  - 250 PSI (17.2 bar) Max. Pressure
  - Temperature Range  
-40 °F (-40°C) to  
300 °F (149°C)

Subject to change without notice

**Ampco Pumps Company**

2045 West Mill Road  
Glendale, WI 53209 USA  
Phone: (800) 737-8671  
(414) 643-1852

Website:  
[www.ampcopumps.com](http://www.ampcopumps.com)

# ZP3 Series Positive Displacement Pumps

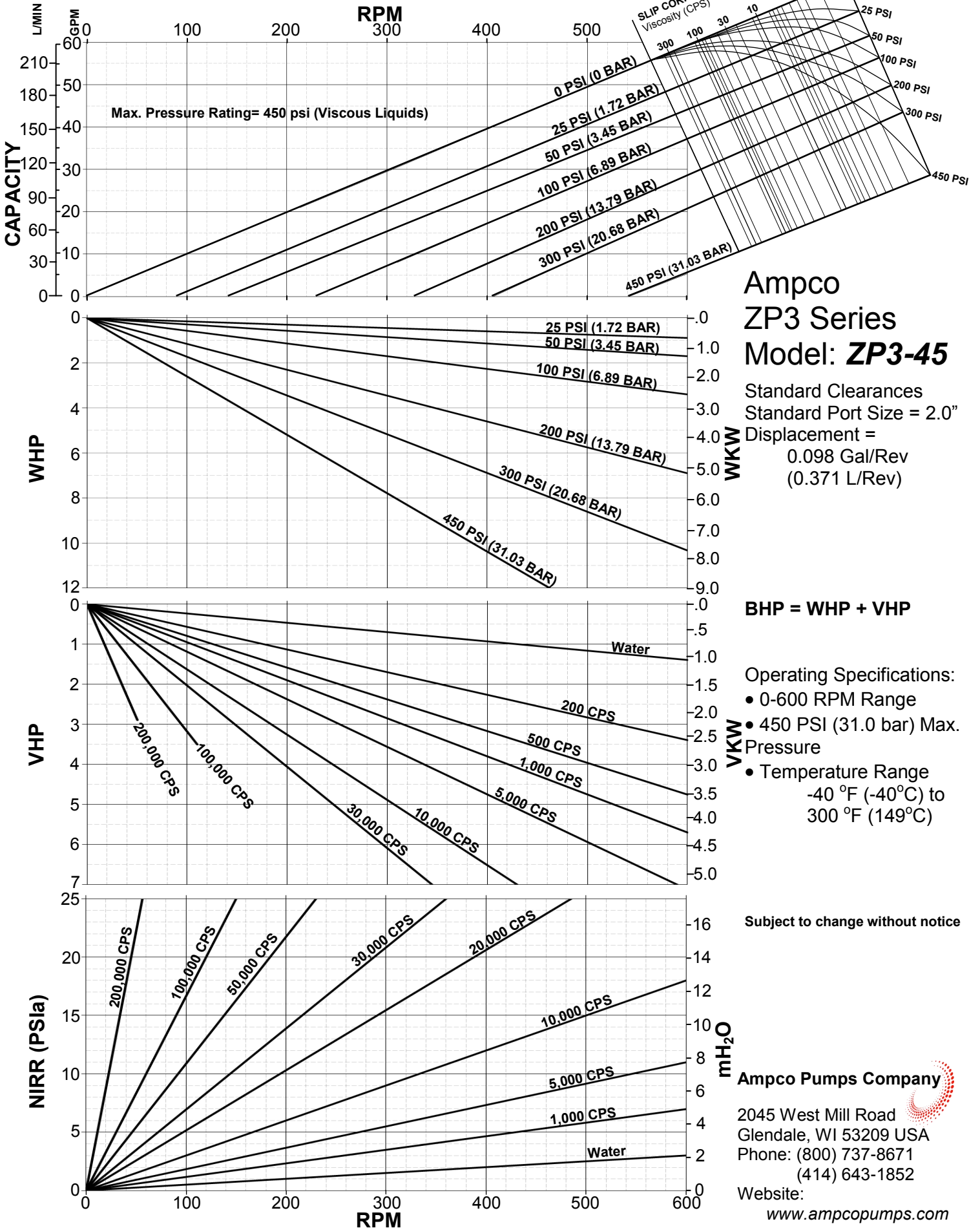

## Ampco ZP3 Series Model: **ZP3-45**

Standard Clearances  
Standard Port Size = 2.0"  
Displacement =  
0.098 Gal/Rev  
(0.371 L/Rev)

**BHP = WHP + VHP**

- Operating Specifications:
- 0-600 RPM Range
  - 450 PSI (31.0 bar) Max. Pressure
  - Temperature Range  
-40 °F (-40°C) to  
300 °F (149°C)

Subject to change without notice

**Ampco Pumps Company**

2045 West Mill Road  
Glendale, WI 53209 USA  
Phone: (800) 737-8671  
(414) 643-1852

Website:  
[www.ampcopumps.com](http://www.ampcopumps.com)

# ZP3 Series Positive Displacement Pumps

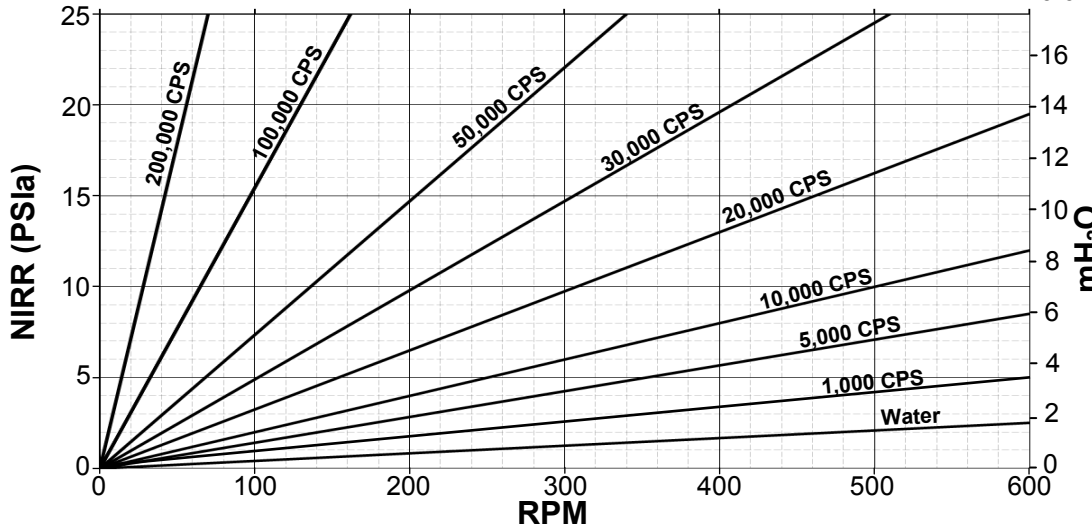
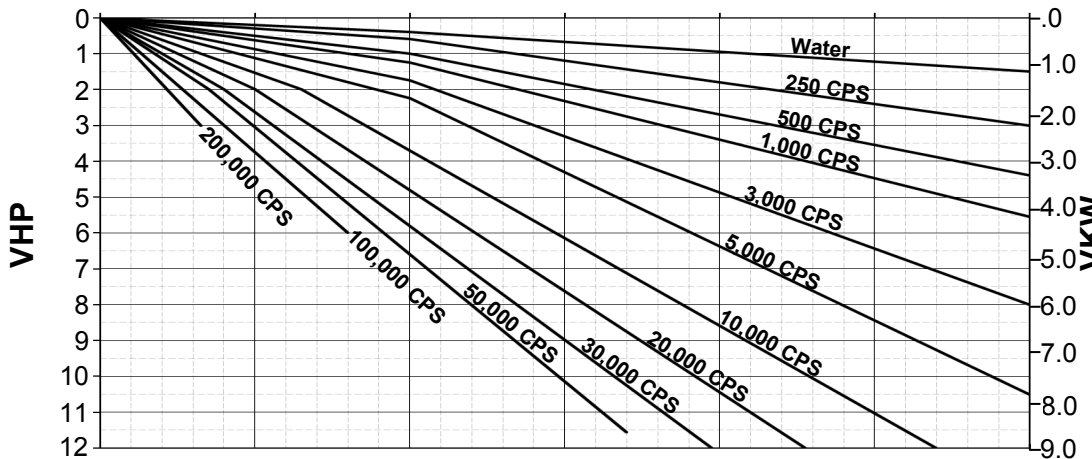
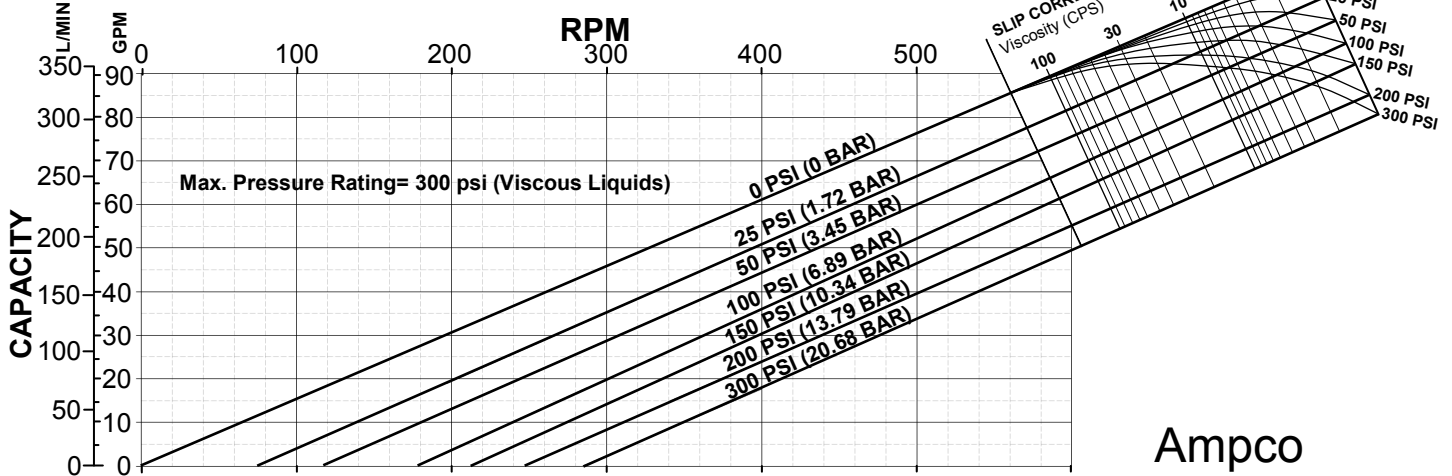

## Ampco ZP3 Series Model: **ZP3-60**

Standard Clearances  
Standard Port Size = 2.5"  
Displacement =  
0.153 Gal/Rev  
(0.579 L/Rev)

**BHP = WHP + VHP**

- Operating Specifications:
- 0-600 RPM Range
  - 300 PSI (20.7 bar) Max. Pressure
  - Temperature Range  
-40 °F (-40°C) to  
300 °F (149°C)

Subject to change without notice

**Ampco Pumps Company**

2045 West Mill Road  
Glendale, WI 53209 USA  
Phone: (800) 737-8671  
(414) 643-1852

Website:  
[www.ampcopumps.com](http://www.ampcopumps.com)

# ZP3 Series Positive Displacement Pumps

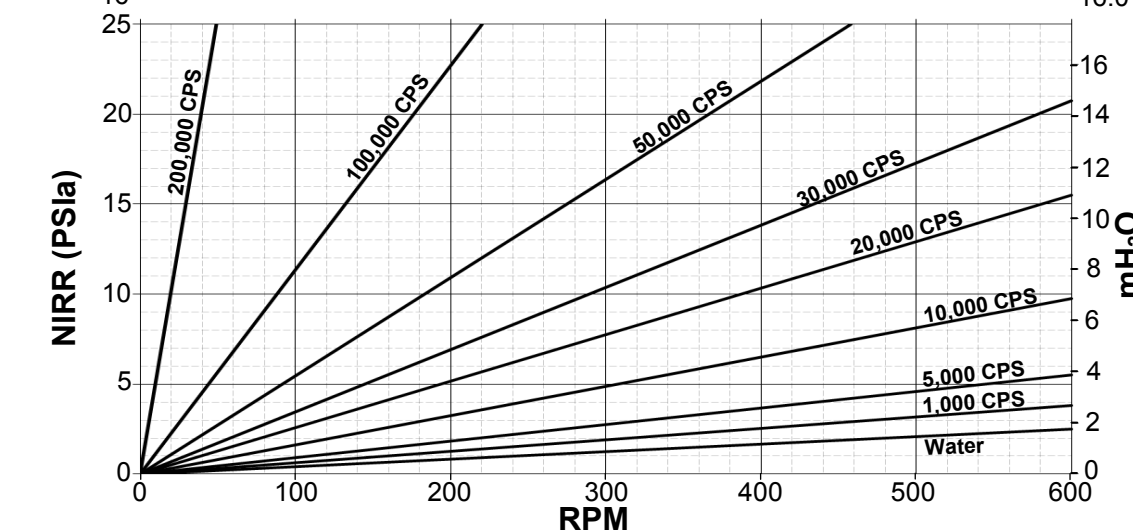
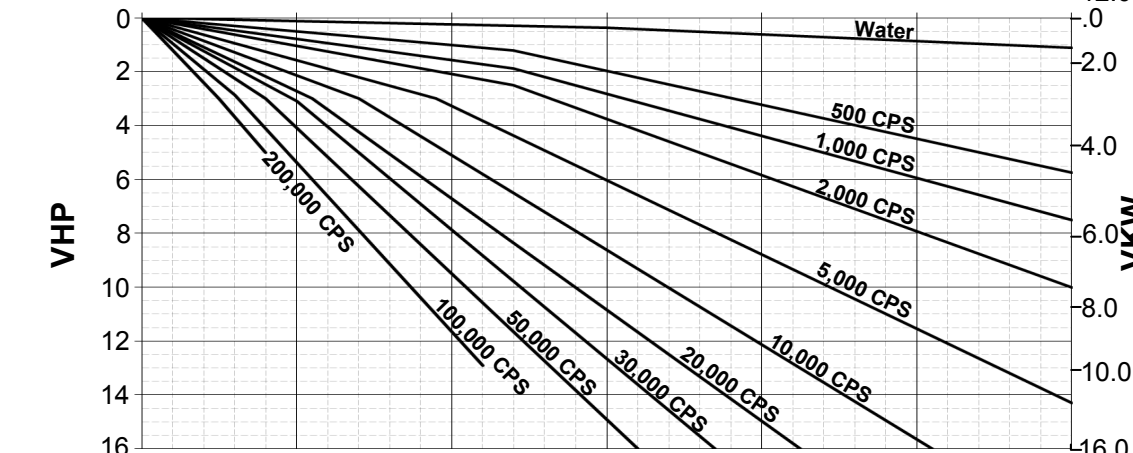
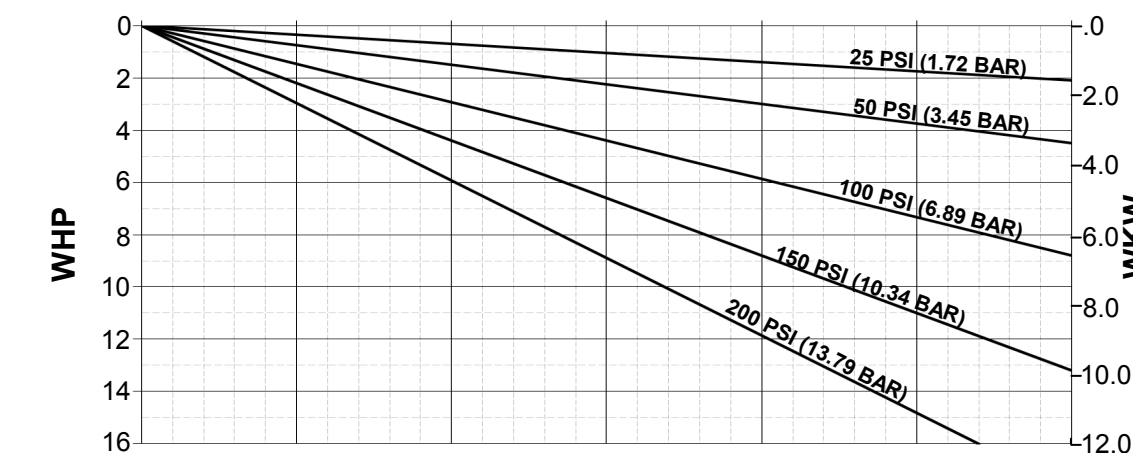
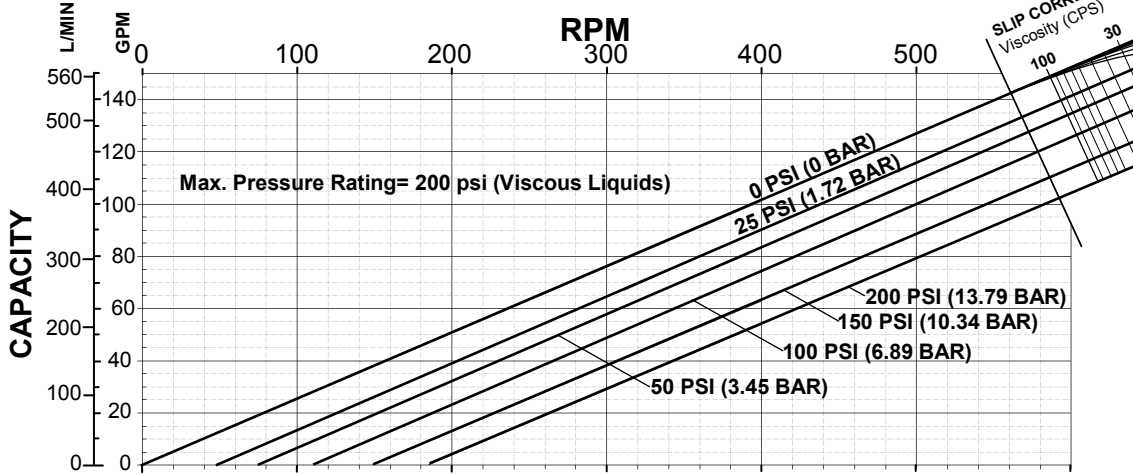

## Ampco ZP3 Series Model: **ZP3-130**

Standard Clearances  
Standard Port Size = 3.0"  
Displacement =  
0.253 Gal/Rev  
(0.958 L/Rev)

**BHP = WHP + VHP**

- Operating Specifications:
- 0-600 RPM Range
  - 200 PSI (13.8 bar) Max. Pressure
  - Temperature Range  
-40 °F (-40°C) to  
300 °F (149°C)

Subject to change without notice

**Ampco Pumps Company**

2045 West Mill Road  
Glendale, WI 53209 USA  
Phone: (800) 737-8671  
(414) 643-1852

Website:  
[www.ampcopumps.com](http://www.ampcopumps.com)

# ZP3 Series Positive Displacement Pumps

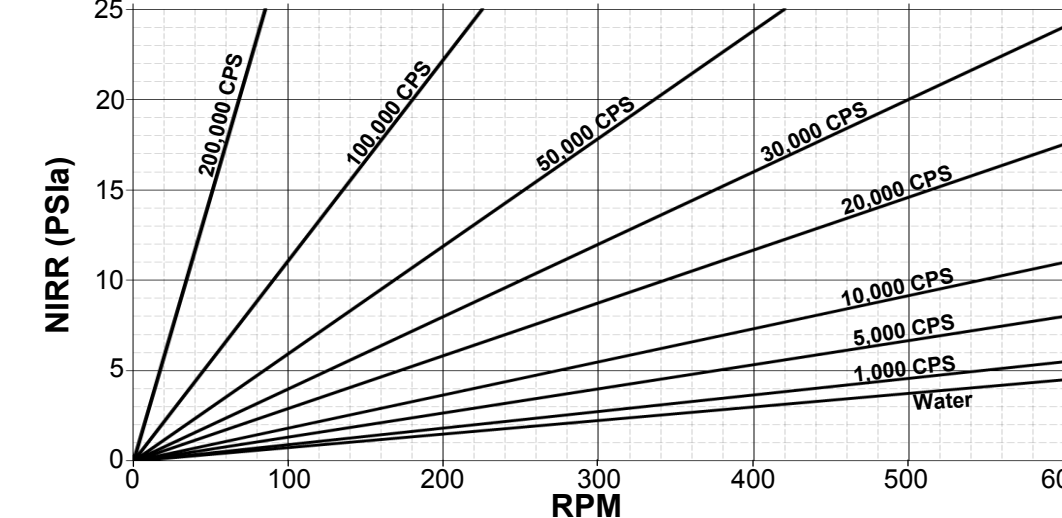
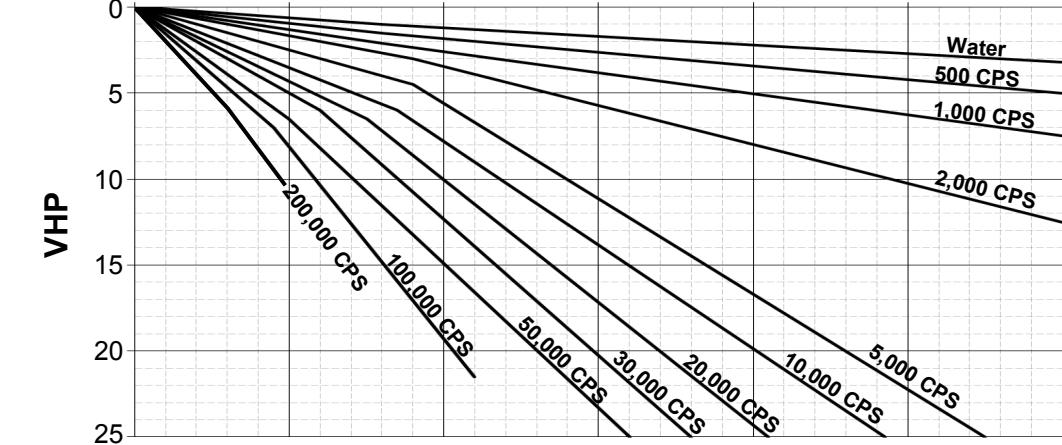
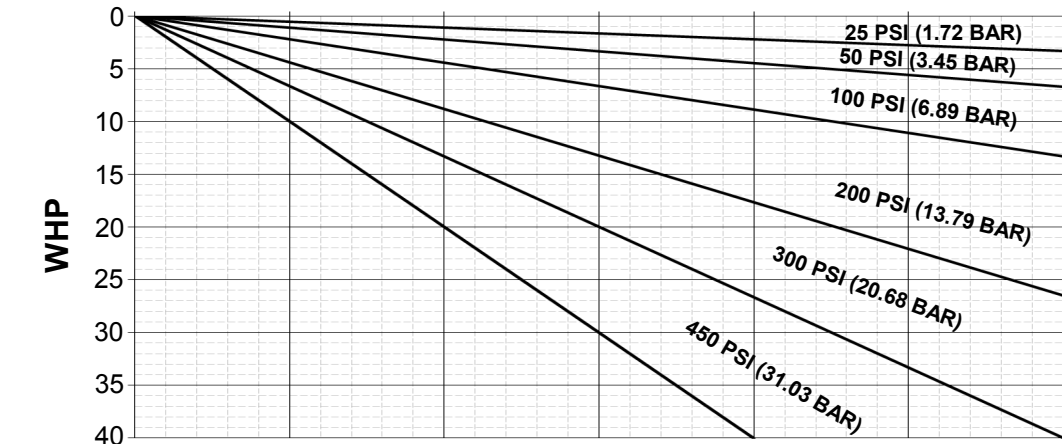
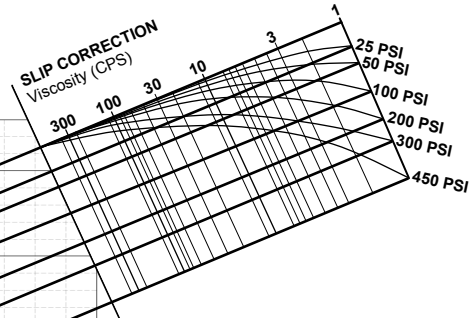
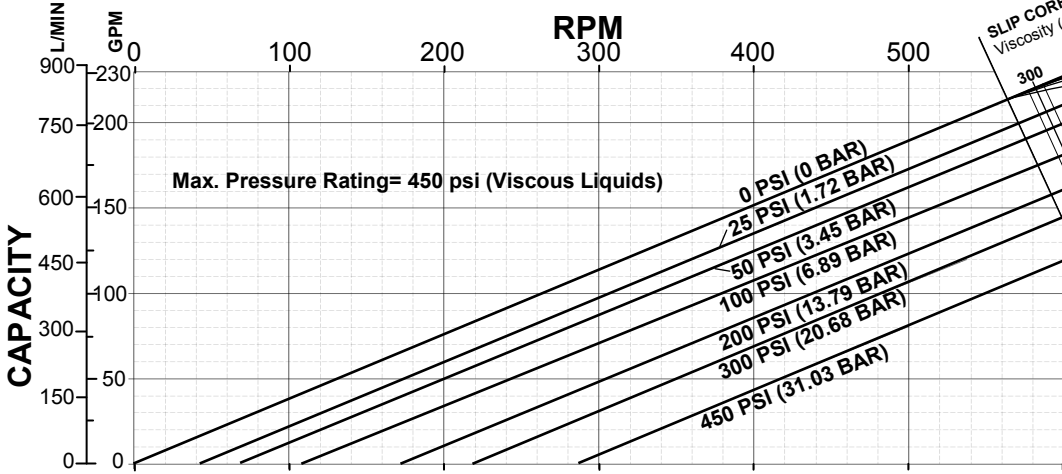

## Ampco ZP3 Series Model: **ZP3-180**

Standard Clearances  
Standard Port Size = 3.0"  
Displacement =  
0.380 Gal/Rev  
(1.438 L/Rev)

**BHP = WHP + VHP**

- Operating Specifications:
- 0-600 RPM Range
  - 450 PSI (31.0 bar) Max. Pressure
  - Temperature Range  
-40 °F (-40°C) to  
300 °F (149°C)

Subject to change without notice

**Ampco Pumps Company**

2045 West Mill Road  
Glendale, WI 53209 USA  
Phone: (800) 737-8671  
(414) 643-1852

Website:  
[www.ampcopumps.com](http://www.ampcopumps.com)



# ZP3 Series Positive Displacement Pumps

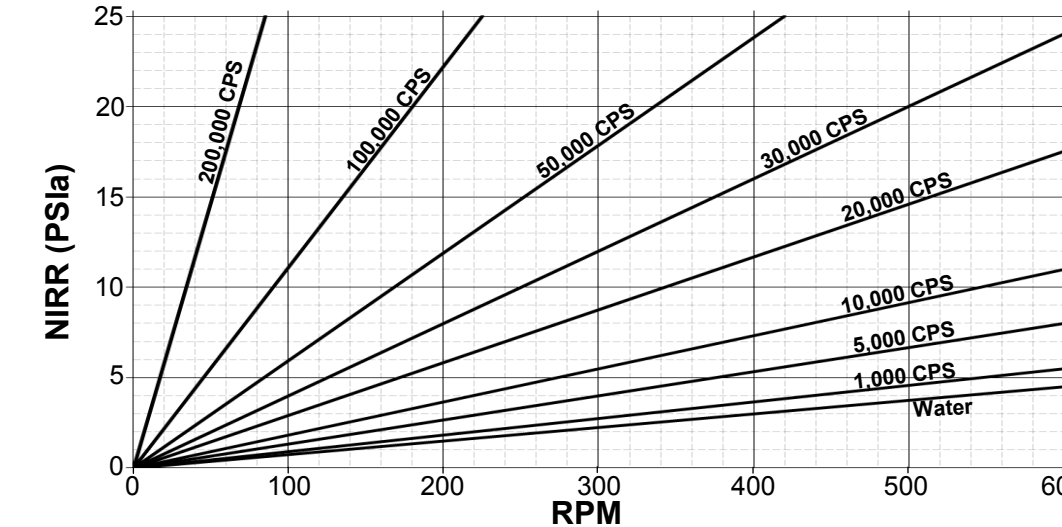
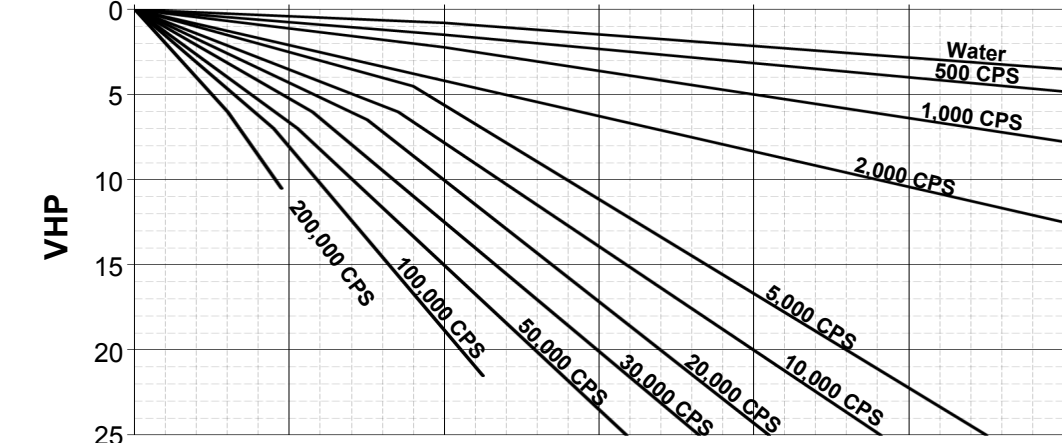
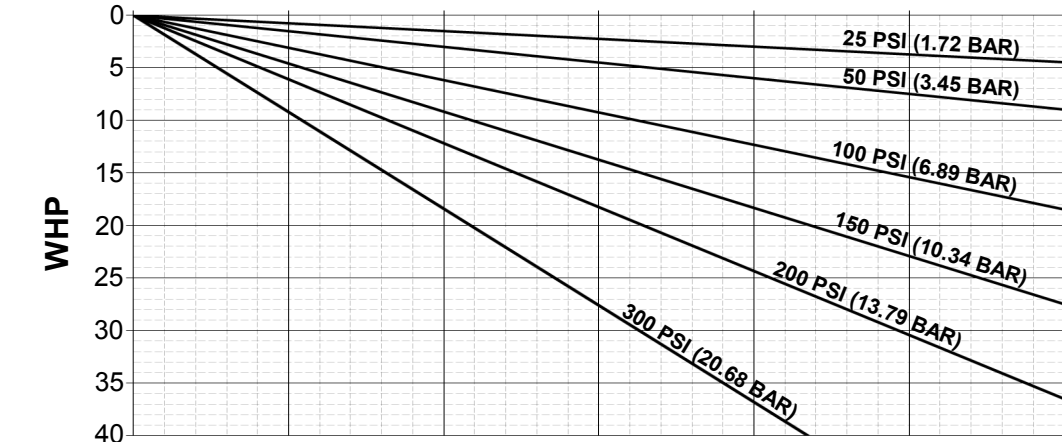
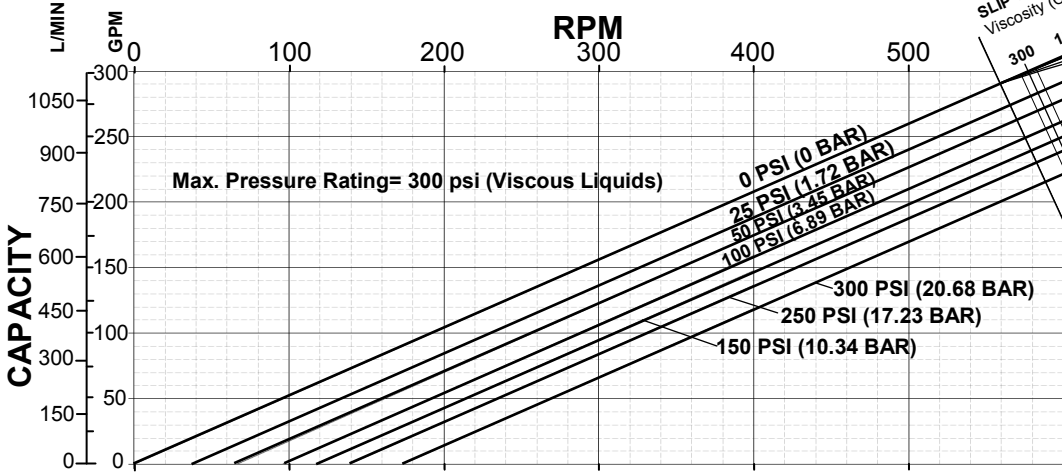

## Ampco ZP3 Series Model: **ZP3-220**

Standard Clearances  
Standard Port Size = 4.0"  
Displacement =  
0.521 Gal/Rev  
(1.972 L/Rev)

**BHP = WHP + VHP**

- Operating Specifications:
- 0-600 RPM Range
  - 300 PSI (20.68 bar) Max. Pressure
  - Temperature Range  
-40 °F (-40°C) to  
300 °F (149°C)

Subject to change without notice

**Ampco Pumps Company**

2045 West Mill Road  
Glendale, WI 53209 USA  
Phone: (800) 737-8671  
(414) 643-1852

Website:  
[www.ampcopumps.com](http://www.ampcopumps.com)