

METAL MAG™ LINE

ULTRACHem® Series

ANSI DIMENSIONAL MAG DRIVE

Models UC1516, UC1518, & UC326

OPERATIONAL MANUAL

Record your Model and Serial Number here.

MODEL NUMBER _____

SERIAL NUMBER _____

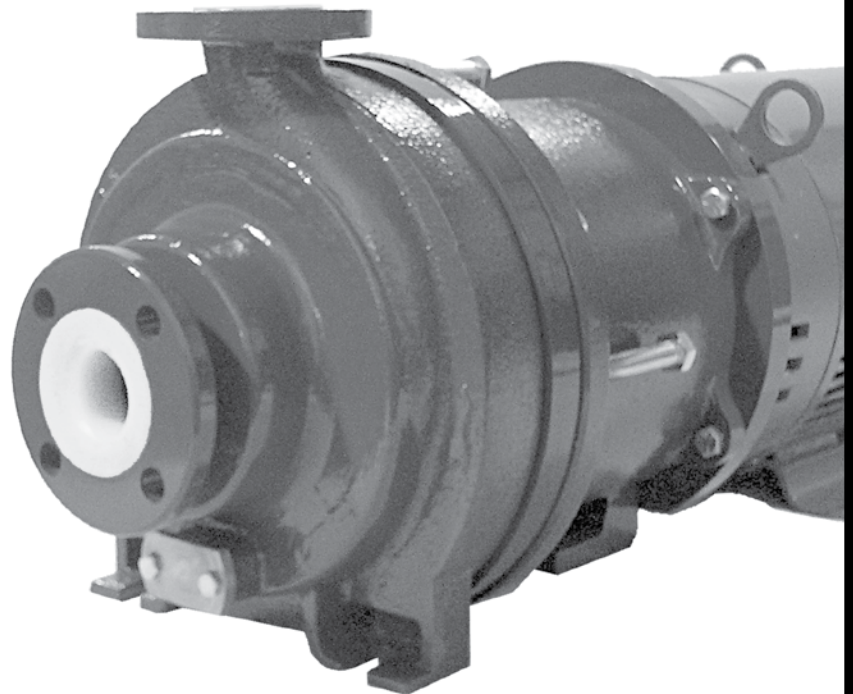

FINISH THOMPSON INC.

Table of Contents

Warranty Statement	3	
Safety Precautions	3	
ULTRAChem Features	4	
ULTRAChem Capabilities.....	4	
Maximum Allowable Horsepower.....	4	
Minimum Allowable Flow Rate.....	5	
Unpacking and Inspection.....	6	
Model Number and Serial Number.....	6	
Installation		
Pumps with Motors	6	
Pumps without Motors	7-8	
Foundation	8	
Baseplate	8-9	
Piping.....	9	
Electrical	10	
Operation		
Pre-operation Inspection.....	10	
Start-up and Operation.....	10	
Shutdown.....	11	
Disassembly/Reassembly		
Disassembly of Pump End	11	
Disassembly of Power End (Motor Side)	12	
Examination	12	
Replacing Wear Components.....	13	
Shaft Support/Front Thrust Washer	13	
Installation of Replacement Support/Front Thrust Washer	13	
Impeller Assembly Removal & Replacement	13	
Rear Sealing Ring	14	
Impeller Assembly Removal and Replacement	14	
Impeller Bushings.....	15	
Power End Reassembly	15	
Pump End Reassembly.....	15-16	
Troubleshooting		17
General Notes		
Important Notice	17	
Chemical Reaction Disclaimer.....	17	
Helpful Hints	17	
Ordering Spare Parts	17	
Exploded View Drawing		18
Parts List		19-23

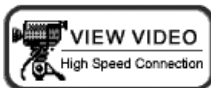

NOTE: Items with this icon have maintenance videos available at www.finishthompson.com. When you see this item in the instructions that follow, click on the icon to view the instruction video.

WARRANTY

Finish Thompson, Inc (manufacturer) warrants this pump product to be free of defects in materials and workmanship for a period of two years from date of purchase by original purchaser. If a warranted defect, which is determined by manufacturer's inspection, occurs within this period, it will be repaired or replaced at the manufacturer's option, provided (1) the product is submitted with proof of purchase date and (2) transportation charges are prepaid to the manufacturer. Liability under this warranty is expressly limited to repairing or replacing the product or parts thereof and is in lieu of any other warranties, either expressed or implied. This warranty does apply only to normal wear of the product or components. This warranty does not apply to products or parts broken due to, in whole or in part, accident, overload, abuse, chemical attack, tampering, or alteration. The warranty does not apply to any other equipment used or purchased in combination with this product. The manufacturer accepts no responsibility for product damage or personal injuries sustained when the product is modified in any way. If this warranty does not apply, the purchaser shall bear all cost for labor, material and transportation.

Manufacturer shall not be liable for incidental or consequential damages including, but not limited to process down time, transportation costs, costs associated with replacement or substitution products, labor costs, product installation or removal costs, or loss of profit. In any and all events, manufacturer's liability shall not exceed the purchase price of the product and/or accessories.

SAFETY PRECAUTIONS

- ⚠ WARNING:** READ THIS MANUAL COMPLETELY BEFORE INSTALLING AND OPERATING THIS UNIT. FAILURE TO FOLLOW THESE PRECAUTIONS CAN RESULT IN SERIOUS INJURY OR DEATH.
- ⚠ WARNING:** Magnetic force hazard. This pump should only be disassembled and assembled using the recommended procedures. The magnetic attraction is powerful enough to rapidly pull the motor end and the wet end together. ALWAYS use the jackscrews (item 14) to assemble/disassemble the pump. Do not place fingers between the mating surfaces of the motor and wet ends to avoid injuries. Keep the drive magnet and impeller assembly away from metal chips or particles.
- ⚠ WARNING:** Magnetic Field Hazard. This pump contains powerful rare earth magnets. When the pump is disassembled (not connected to a motor) and the magnets are exposed, these magnets produce powerful magnetic fields. Individuals with cardiac pacemakers, implanted defibrillators, other electronic medical devices, metallic prosthetic heart valves, internal wound clips (from surgery), metallic prosthetic devices or sickle cell anemia must not handle or be in the proximity of the magnets contained inside the pump. Consult a health care provider for specific recommendations before working with this pump.
- ⚠ WARNING:** Hot surfaces. This pump is capable of handling liquids with temperatures as high as 250° F. This may cause the outer areas of the pump to become hot as well and could cause burns.
- ⚠ WARNING:** Check for leaks on a regular basis. If any leaks are found, the pump must be repaired immediately.
- ⚠ WARNING:** Rotating Parts. This pump has components that rotate while in operation. Follow local safety standards for locking out the motor from the power supply during maintenance or service.
- ⚠ WARNING:** Chemical Hazard. This pump is used for transferring many types of potentially dangerous chemicals. *Always* wear protective clothing, eye protection and follow standard safety procedures when handling corrosive or personally harmful materials. Proper procedures should be followed for draining and decontaminating the pump before disassembly and inspection of the pump. There may be small quantities of chemicals present during inspection.
- ⚠ WARNING:** Never run pump at less than minimum flow or with the discharge valve closed. This could lead to pump failure.
- ⚠ WARNING:** Never operate the pump without safety features installed.
- ⚠ WARNING:** The pump and associated components are heavy. Failure to properly support the pump during lifting and movement could result in serious injury or damage to the pump and components.
- ⚠ CAUTION:** Do not run the pump dry. This pump should never be started without liquid in the casing. This could damage the pump. The fluid being transferred by the pump lubricates the pump components. Even short periods of running the pump dry could damage the pump. It is recommended that run dry protection be used. Optional electronic power monitors are available to help protect against run dry.
- ⚠ CAUTION:** The correct o-ring material must be chosen to ensure compatibility with the fluid being pumped. If the incorrect material is chosen, it can lead to swollen or degrading o-rings that allow leaking. O-ring material selection is the responsibility of the end user.
- ⚠ CAUTION:** Never start or operate with a closed suction valve. Never operate with a closed discharge valve.
- ⚠ CAUTION:** Always provide adequate NPSHa (net positive suction head available).

ADDITIONAL SAFETY PRECAUTIONS FOR ATEX COMPLIANT PUMPS

- ⚠ WARNING:** ATEX compliant pumps must be cleaned on a regular basis to avoid buildup of explosive dust greater than 5 mm.
- ⚠ WARNING:** ATEX pumps must use a power monitor, flow switch, pressure switch or similar device to help protect against dry running, closed discharge valve and de-coupling. Any of these conditions could lead to a rise in surface temperature of the pump.

ULTRAChem Features

The Finish Thompson ULTRAChem is a sealless, magnetically driven, ANSI dimensional, ETFE lined, chemical pump. It has been specifically designed for corrosive chemical applications in a wide range of industrial services.

The ULTRAChem features a closed impeller, suction straightening vanes, balanced axial thrust with a rear sealing ring, balance holes and balanced radial thrust due to the modified concentric volute shape.

The ULTRAChem uses standard silicon carbide shaft, thrust bearings and bushings (optional carbon bushings allow limited run dry capabilities). All metallic components are steel or cast ductile iron.

High strength, rare earth neodymium boron iron magnets are used for maximum power and reliability. Finish Thompson's patented magnetic technology ensures an extraordinarily strong, secure coupling between the motor and pump.

The barrier consists of a precision molded carbon filled ETFE liner with an external woven-glass-filled vinyl ester for superior mechanical strength and elimination of eddy currents in the magnetic coupling. The sealless design virtually eliminates maintenance and environmental emissions.

The Easy Set drive feature makes installation of the outer drive quick and easy. It eliminates the need for measuring and ensures that the inner and outer magnets are perfectly aligned to transmit maximum power.

The ULTRAChem has drive hubs and motor adapters for a complete range of NEMA and IEC motor frames. The suction and discharge flanges are drilled for both ANSI and ISO.

These features combine to provide our customers with a pump that offers a broad operating range with outstanding reliability due to minimum hydraulic loads and premium materials of construction.

FTI's ATEX compliant pumps meet Directive 94/9/EC for use in potentially explosive atmospheres.

ULTRAChem Capabilities

Maximum Working Pressure:	175 psi (12 bar)
Maximum Temperature:	250°F (121°C) (application dependent)
Minimum Temperature:	-20°F (-29°C)
Maximum Flow:	325 USgpm (74 m ³ /hr)
Maximum Head:	320 ft (98 m)
Maximum Viscosity:	200 cP
Solids:	Maximum particle size is 50 microns for slurries and 1/64" (.4 mm) for infrequent particles. Maximum hardness is 80 HS. Maximum concentration is 5% by weight. If solids are being pumped, it is recommended the pump have the silicon carbide bushings and thrust washer.

Surface Temperature for ATEX Pumps

Fluid Temperature	Max. Surface Temperature	Temperature Class	Max. Allowable Surface Temperature
88°F (31°C)	153°F (67°C)	T6	185°F (85°C)
195°F (91°C)	206°F (97°C)	T4	275°F (135°C)
250°F (121°C)	272°F (133°C)	T3	392°F (200°C)

Maximum Allowable Horsepower

Do not exceed the maximum horsepower rating for the pump coupling. Refer to the chart below. Use the first six or seven characters from the model number listed on the label found on the motor adapter.

Pump Model	Maximum HP @ 3500 rpm	Maximum kW @ 2900 rpm	Maximum HP @ 1750 rpm	Maximum kW @ 1450 rpm
UC1516A	10	7.5	5	4
UC1516B	20	15	5	4
UC1518A	10	7.5	5	4
UC1518B	20	15	5	4
UC326A	10	7.5	5	4
UC326B	20	15	5	4

Minimum Allowable Flow Rate

Do not allow the flow rate to drop below the minimum flow rate listed in the chart below. Use the first five or six characters from the model number listed on label found on the motor adapter.

Pump Model	Minimum GPM @ 3500 rpm (60 Hz)	Minimum m ³ /hr @ 2900 rpm (50 Hz)	Minimum GPM @ 1750 rpm (60 Hz)	Minimum m ³ /hr @ 1450 rpm (50 Hz)
UC1516	5	1.1	3	.75
UC1518	5	1.1	3	.75
UC326	5	1.1	3	.75

UC1516, UC1518, UC326 Series

Model Codes and Abbreviations

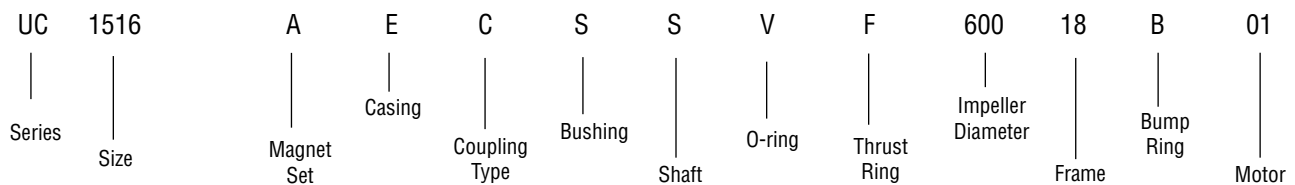

Series: UC

Pump Size: 1516 = 1 1/2" suction x 1" discharge x 6" diameter impeller
 1518 = 1 1/2" suction x 1" discharge x 8" diameter impeller
 326 = 3" suction x 2" discharge x 6" diameter impeller

Magnet set: A = maximum horsepower to 10 @ 3500 rpm (see chart)
 B = maximum horsepower to 20 @ 3500 rpm (see chart)

Casing: E = ETFE-lined ductile iron

Coupling type: C = Close coupled
 F = Bearing frame mounted

Bushing: S = Sintered silicon carbide
 C = Carbon

Shaft: S = Sintered silicon carbide

O-ring: V = FKM
 E = EPDM

Thrust ring: F = Fluorosint®
 S = Silicon Carbide

Impeller diameter: (Impellers available in 1/8" increments)

Note: FLUOROSINT is a registered trademark of Quadrant DSM Engineering Plastic Products.

UC Impeller Diameters:

UC1516 =

637 (6 3/8"); 625 (6 1/4"); 612 (6 1/8"); 600 (6"); 587 (5 7/8"); 575 (5 3/4"); 562 (5 5/8"); 550 (5 1/2"); 537 (5 3/8"); 525 (5 1/4"); 512 (5 1/8"); 500 (5"); 487 (4 7/8"); 475 (4 3/4"); 462 (4 5/8"); 450 (4 1/2"); 437 (4 3/8"); 425 (4 1/4"); 412 (4 1/8"); 400 (4")

UC1518 =

812 (8 1/8"); 800 (8"); 787 (7 7/8"); 775 (7 3/4"); 762 (7 5/8"); 750 (7 1/2"); 737 (7 3/8"); 725 (7 1/4"); 712 (7 1/8"); 700 (7"); 687 (6 7/8"); 675 (6 3/4"); 662 (6 5/8"); 650 (6 1/2"); 637 (6 3/8"); 625 (6 1/4"); 612 (6 1/8"); 600 (6")

UC326 =

637 (6 3/8"); 625 (6 1/4"); 612 (6 1/8"); 600 (6"); 587 (5 7/8"); 575 (5 3/4"); 562 (5 5/8"); 550 (5 1/2"); 537 (5 3/8"); 525 (5 1/4"); 512 (5 1/8"); 500 (5"); 487 (4 7/8"); 475 (4 3/4"); 462 (4 5/8"); 450 (4 1/2"); 437 (4 3/8"); 425 (4 1/4")

Motor frame:

14 = 145TC (available with "A" magnet set only)

18 = 184TC (available with "A" or "B" magnet set)

21 = 215TC (available with "A" or "B" magnet set only)

25 = 256TC (available with "B" magnet set only)

90 = 90 frame with B14 flange (available with "A" magnet set only)

10 = 100/112 frame with B14 flange (available with "A" magnet set only)

13 = 132 frame with B5 flange (available with "A" or "B" magnet set only)

16 = 160 frame with B5 flange (available with "B" magnet set only)

FO = Frame mounted, flood oil

FB = Frame mounted, regreasable bearings

Bump Ring:

B = Non-sparking Bronze

If the bronze bump ring is required for explosion proof environments, add the letter "B" after the two digit motor frame code (14B for example).

Note: Close coupled and frame mounted pumps with the bronze bump ring option "B" will be ATEX certified. All ATEX certified pumps must utilize the bronze bump ring.

Unpacking and Inspection

Unpack the pump and examine for any signs of shipping damage.

If damage is detected, save the packaging and notify the carrier immediately.

To install the pump, follow the installation instructions provided.

⚠ WARNING: The pump and associated components are heavy. Failure to properly support the pump during lifting and movement could result in serious injury or damage to the pump and components. (See figure A)

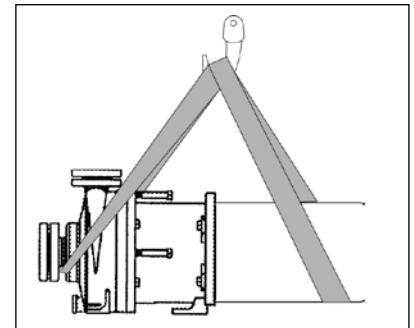

Model Number and Serial Number

Record the model number and serial number for future reference. Use the location provided on the front cover of this manual. This is important information when ordering replacement parts or when technical assistance is required. The model and serial number are found on a label located on the motor adapter.

Installation

To install a motor to a pump end, see section Assembly of Pumps without Motors, and then proceed to section Foundation.

Note: A hydrostatic test was performed prior to shipment. It is normal for a small amount of water to be retained inside the pump.

Pumps with Motors:

Proceed to Foundation Section.

Pumps without Motors:



1. Carefully place the motor on a suitable, level work surface (a nonmagnetic surface is preferred). Make sure the work surface is free of metal chips or particles.
2. Coat the motor shaft with anti-seize paste.

⚠ Magnetic Force Hazard. This pump should only be disassembled and assembled using the recommended procedures. The magnetic attraction is powerful enough to rapidly pull the motor end and the wet end together. ALWAYS use the jackscrews (item 14) to assemble/disassemble the pump. Do not place fingers between the mating surfaces of the motor and wet ends to avoid injuries. Keep the drive magnet and impeller assembly away from metal chips or particles.

⚠ CAUTION: Keep the drive hub away from the open end of the motor adapter and barrier. Strong magnetic attraction could allow the drive hub to enter the motor adapter resulting in injury or damage.

3. For **160 B5 IEC** frames only:
 - A. Place the vapor protection ring into the groove on the motor adapter flange (Item 10) Use petroleum jelly or similar substance to help keep the o-ring in place.
 - B. Place the motor adapter flange into position on the motor face using customer supplied hardware.

Note: Hardware to attach the motor (not shown) to the adapter flange (Item 10) is to be supplied by customer due to variations in B5 frame motors.

 - C. Continue to step 5.

4. For **NEMA 143-145TC, 182-184TC, 213-215TC, & 254-256TC** motor frames:
 - A. Slide shaft adapter onto motor shaft until end of shaft is firmly against retaining ring. *See figure 1.* The shaft adapter is held to a tight tolerance with motor shaft. It may be necessary to tap the shaft adapter into position using a dead blow hammer.
 - B. Using a 3/16" T-handled Allen wrench, tighten both setscrews to 228 in-lbs.



figure 1

5. For **90, 132, & 160 IEC** motor frames:
 - A. Slide the shaft adapter onto motor shaft until end of shaft is firmly against retaining ring. The shaft adapter is held to a tight tolerance with the motor shaft. It may be necessary to tap the shaft adapter into position using a dead blow hammer.
 - B. Install the appropriate hex bolt, drive washer, and lock washer (Items 18, 19, & 20) into the end of the motor shaft and then tighten to the following torque settings:
 - i. 90 frame B14: 120 in-lbs
 - ii. 132 frame B5: 35 ft-lbs
 - iii. 160 frame B5: 90 ft-lbs

6. For **100/112 IEC frame B14 motor** frames:
 - A. Slide the shaft adapter onto motor shaft until end of shaft is firmly against retaining ring. The shaft adapter is held to a tight tolerance with motor shaft. It may be necessary to tap the shaft adapter into position using a dead blow hammer.
 - B. Install bolt and drive washer (Items 18 & 20), tapered side out, and torque to 250 in-lbs.

7. Using a 3/4" socket, unbolt the wet end (Items 1 through 7) from the motor adapter (Item 9) by removing the (4) 1/2" hex head cap screws (Item 15). Extend the (2) jackscrews (Item 14) using a 3/4" socket, turn the jackscrews clockwise until they are fully extended. *See figure 2.*

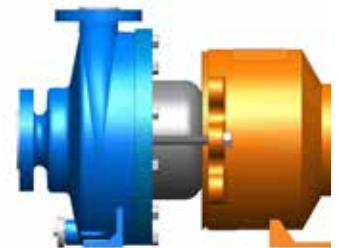

figure 2

8. Check to ensure vapor protection o-ring is present and undamaged in the groove on the motor adapter. Use petroleum jelly or similar substance to help keep the o-ring in place.

9. Slide the motor adapter over the shaft adapter and secure the motor face using hex head bolts (Items 16 & 16A) and lock washers. *See figure 3.* Torque the hex head bolts to the following values:

- A. 145TC 3/8-16 bolt: 75 ft-lbs
- B. 182/184TC, 213/215TC, 254/256TC 1/2-13 bolt: 75 ft-lbs
- C. IEC 90 & 100/112 M8-1.25 bolt: 120 in-lbs
- D. IEC 132 M12-1.75 bolt: 35 ft-lbs

Note: Hardware to attach motor (not shown) to motor adapter (Item 9) is to be supplied by customer due to variations in B5 frame motors.

- E. IEC 160 1/2-13 bolt: 75 ft-lbs

Note: Bolts are for motor adapter to motor adapter flange for this motor size only.

10. Place a thin coat of anti-seize paste on the magnet drive hub on the unpainted fit diameter. *See figure 4.*
11. Using the threaded studs in the shaft adapter as a guide, slide the magnet hub onto the shaft adapter. The magnet hub and shaft adapter are held in close tolerance to one another. Use two M8-1.25 hex head bolts to draw the hub onto the adapter as necessary. *See figure 5.* Avoid hitting the outer edge of the magnet hub as impact can damage the glue bond between the magnet and the hub.
12. Secure the magnet hub to the shaft adapter with the two M8 hex head bolts and lock washers as well as the two M8 hex nuts with lock washers. Torque the bolts and nuts to 120 in-lbs.

Note: Use supplied cardboard tube to help protect outer drive magnets from damage from tools. Be sure to remove tube after drive is securely attached. Save tube for potential future repairs. If your pump did not ship with cardboard tube, consult spare parts list for ordering information.

Pump to Motor Assembly

1. Place the front vapor protection o-ring (Item 24) into the groove on the motor adapter. *See arrow on figure 5.*
2. Liberally apply a suitable lubricant to the o-ring.
3. Turn the two jackscrews clockwise until the heads touch the motor adapter.
4. Carefully slide the wet end towards the motor adapter until it touches the jack screws. There will be some magnetic attraction. *See figure 6.*
5. Slowly and evenly, turn the jackscrews counterclockwise to allow the wet end to slowly slide into the motor adapter. When the jackscrews are fully retracted, lift the wet end slightly and slide it onto the motor adapter's locating flange, being careful not to pinch or cut the vapor protection o-ring.
6. Bolt the wet end to the motor adapter by re-installing the (4) 1/2" hex head cap screws and torque evenly to 75 ft-lbs.

Foundation

1. The foundation that the pump will be sitting on should be strong enough to support the pump as well as absorb any vibration that the pump will produce. A concrete platform should be acceptable. Bolts embedded in the concrete can be placed by using a template or drawing. *See figure 7.* The use of a pipe sleeve larger than the bolt will compensate for base movement for final bolt location.
2. You must allow a gap no greater than 1 1/2 inches between the base and foundation for grouting.

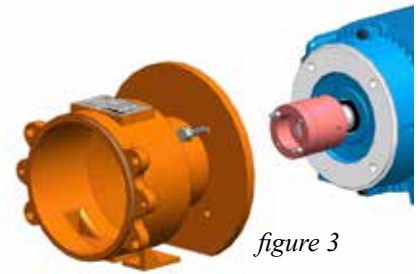

figure 3

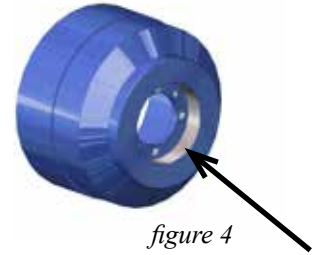

figure 4

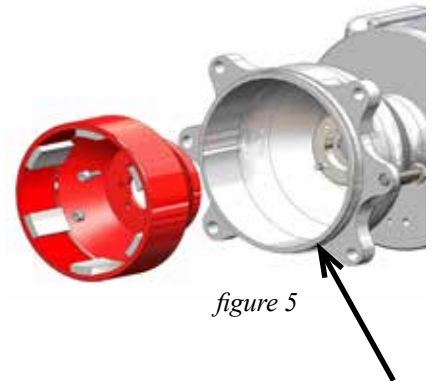

figure 5

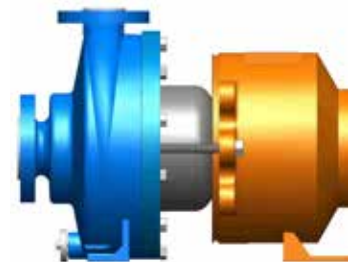

figure 6

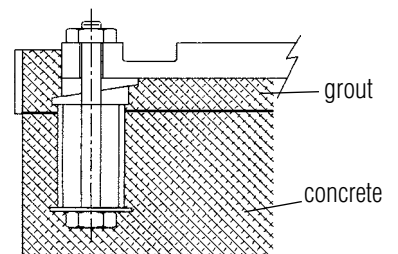

figure 7

Base plate

1. The base plate of the ULTRaChem must be placed on the foundation using two sets of wedges or shims. These shims should be placed on each side of the foundation bolts. Provide enough clearance for proper grouting.
2. Remove any water or other debris from the anchor bolt holes prior to grouting.
3. Carefully lower the base plate onto the foundation bolts.
4. Level the base plate to within 1/8-inch over the length and 1/16-inch over the width. This can be done by adjusting the wedges.
5. Hand tighten the bolts.

Grout the base plate

1. Ensure that the area that is to be grouted is clean. Follow instructions from the grout manufacturer.
2. Erect a dam around the foundation. Insure that the foundation is thoroughly wetted.
3. Pour grout in the dam and completely fill under and around the base plate to the level of the dam. Make sure that any air bubbles are removed as it is poured. It is recommended that non-shrinking grout be used.
4. Permit the grout to set at least 48 hours.
5. Tighten the foundation bolts.

⚠ CAUTION: Do not operate the pump until it is securely fastened!

Piping

1. The pump should be installed as near to the suction source as possible.
2. It is recommended that pipes are supported as close as possible to the pump and all flanges line up. This will minimize any pipe strain.
3. The suction side of the pump should be as straight and short as possible to minimize pipe friction or a length at least ten times the inlet diameter should follow any elbows.
4. The suction or inlet line should be at least as large as the suction inlet port or one pipe size larger so that it does not affect the NPSHa. Do not reduce the suction line size.
5. The suction line should not have any high spots. This can create air pockets. The suction piping should be level or slope slightly upward to the pump. *See figure 8.*
6. The NPSH available to the pump must be greater than the NPSH required. Filters, strainers, and any other fittings in the suction line will lower the NPSH available and should be calculated into the application.
7. A check valve and a control valve (if used) or isolation valve should be installed on the discharge line. The control valve is used for regulating system flow. An isolation valve is used to make the pump accessible for maintenance. It is recommended that the control or isolation valve be closed prior to stopping or starting the pump. The check valve is installed to protect the pump against water hammer damage. These recommendations are particularly important when the static discharge head is high.
8. It is advisable to install a flush system in the piping to allow the pump to be flushed before the pump is removed from service.
9. When connecting piping to the pump suction and discharge flanges, if lock washers are used, install under the head of the bolt. *See figure 9.*

figure 8

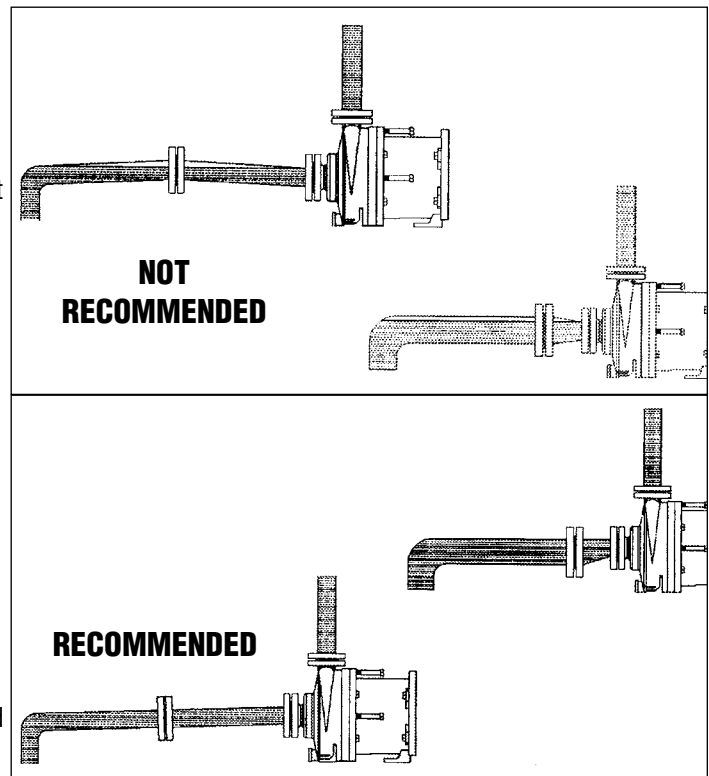
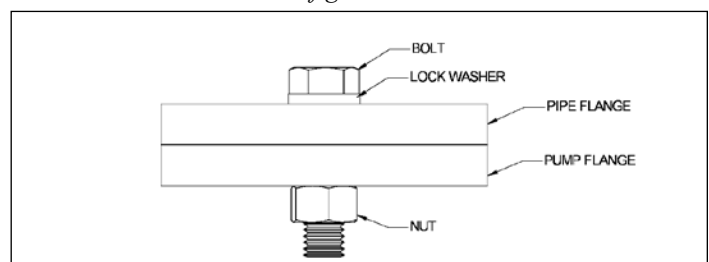

figure 9



Motor/Electrical

Install the motor according to NEC requirements and local electrical codes. The motor should have overload protection. The use of a power monitor is highly recommended.

Note: All ATEX certified pumps must use a power monitor.

1. The motor must be installed with flexible conduit in order to allow a minimum of 6" of motor movement so that the pump can be disassembled.
2. Check all electrical connections with the wiring diagram on the motor. Insure that the voltage, frequency, and horsepower on the motor comply with the line circuitry.
3. If utilized, check that the power monitor has been properly installed in accordance with the manufacturers directions.

 **CAUTION:** Do not operate the pump to check rotation until the pump is full of liquid.

Operation

Pre-Operation Inspection

Prior to the first operation of the pump, perform the following inspections:

 **WARNING:** Lock out power to the driver to prevent accidental motor start-up and physical injury.

1. Insert a screwdriver through the fan cover and rotate the fan. It should move without restrictions.
2. Verify that all flange and hold down bolts are tightened.

Start-up and Operation

1. This pump must be filled from a flooded suction tank (gravity) or primed with liquid from an outside source. The ULTRAChem is not self-priming.
2. Ensure that the pump is full of liquid and the inlet (suction) valve is open.
3. Open the discharge valve completely and then close it so that there is no trapped air in the suction and discharge line.
4. After the pump is full of liquid, check that the rotation of the motor/ pump is in the correct direction. This can be achieved by jogging the motor for approximately 1/2 second. The motor rotation can be observed from the fan end. Correct rotation when viewed from the fan end is clockwise.

Note: A pump running backwards will pump but at a greatly reduced flow and pressure.

5. Turn the pump on. Slowly open the discharge valve. Check pump for proper flow and pressure, and that pump runs without excessive noise or vibration.
6. Keep the suction valve in the fully open position. Never use the suction valve to regulate the flow rate. Use the discharge valve only.

Note: It is not necessary to jog the motor or adjust the valves on subsequent pump starts provided that the pump and piping remain full of liquid.

 **CAUTION:** Do not run the pump dry. This could damage the pump. The fluid being transferred by the pump lubricates the pump. Even short periods of running the pump dry could damage the pump. It is recommended that a run dry protection device be used.

 **CAUTION:** Do not dead head the pump. Running the pump at zero flow will cause any liquid inside the pump to elevate rapidly in temperature. This will continue until the boiling point of the liquid is reached. The liquids will flash to vapor, causing the pump to run dry, and destroy the pump. Run dry protection in the form of a power monitor is recommended.

 **WARNING:** All ATEX compliant pumps must use a power monitor to protect against running dry, closed discharge valve, and pump decoupling. Any of these conditions could lead to elevated surface temperatures.

 **CAUTION:** Cavitation for an extended period of time can cause pitting and damage on the pump components. Make certain NPSHa is greater than pump NPSHr.

 **CAUTION:** Water hammer. Rapid changes in the fluid's velocity can cause large, sudden pressure surges. These pressure surges can damage the pump, plumbing and instrumentation. Common causes are rapidly closing valves. Check valves on the suction can also cause water hammer if the liquid has time to reverse direction before the valve closes.

Shutdown

Use the following procedures to shut the pump down.

1. Slowly close the discharge valve .
2. Shut off the motor.
3. Close the suction valve.

Disassembly/Reassembly



Disassembly

Pump End

- ⚠ WARNING: Rotating Parts.** This pump has components that rotate while in operation. Follow local safety standards for locking out the motor from the power supply during maintenance or service.
- ⚠ WARNING: Chemical Hazard.** This pump is used for transferring many types of potentially dangerous chemicals. Always wear protective clothing, eye protection and follow standard safety procedures when handling corrosive or personally harmful materials. Proper procedures should be followed for draining and decontaminating the pump before disassembly and inspection of the pump. There may be small quantities of chemicals present during inspection.
- ⚠ WARNING: The pump must be thoroughly flushed of any hazardous materials and all internal pressure relieved prior to opening the pump.**
- ⚠ WARNING: Magnetic force hazard.** This pump should only be disassembled and assembled using the recommended procedures. The magnetic attraction is powerful enough to rapidly pull the motor end and the wet end together. ALWAYS use the jackscrews (item 14) to assemble/disassemble the pump. Do not place fingers between the mating surfaces of the motor and wet ends to avoid injuries. Keep the drive magnet and impeller assembly away from metal chips or particles.

1. Stop the pump, lock out the motor starter, close all the valves that are connected to the pump, and drain/decontaminate the pump. The ULTRAChem is supplied with a casing drain to help drain and decontaminate the pump. If the drain flange has been removed to drain/decontaminate the pump, reinstall the flange (item 11) and use a new gasket (item 11A). Torque the two flange bolts ($\frac{1}{4}$ ") (item 11B) to 6.5 ft-lbs (8.5 N-m).
2. Allow the pump to reach ambient temperatures prior to performing maintenance.
3. Remove the mounting bolts that attach the motor to the base, if any. Using a $\frac{3}{4}$ " socket, remove the (4) $\frac{1}{2}$ " bolts (item 15) that secure the motor adapter (item 9) to the clamp ring (item 7). *See figure 10.*

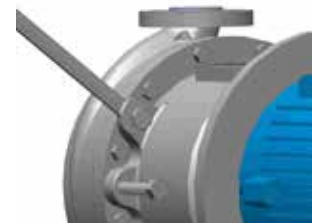

figure 10

4. Separate the magnetic coupling between the drive end and the pump end by using the (3) jackscrews (item 14). Using a $\frac{3}{4}$ " socket turn the jackscrews clockwise. Be sure to turn the jackscrews evenly. Turn the jackscrews until they are fully extended. *See figure 11.*
- ⚠ CAUTION:** After removal of the drive end, the jackscrews should be left fully engaged in the adapter to prevent accidental attraction of the magnetic coupling.

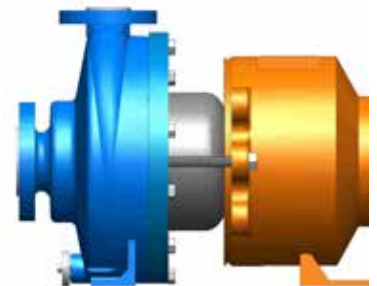

figure 11

5. Using a $\frac{9}{16}$ " socket, remove the (12) $\frac{3}{8}$ " hex head bolts (item 13) that connect the clamp ring to the casing (item 1). *See figure 12.*
6. Remove the clamp ring from the back of the barrier assembly (item 6).
7. Place the casing/barrier assembly on a table with the suction flange of the casing facing down. Carefully remove the barrier assembly from the casing. It may be necessary to gently pry with a flat blade screwdriver between the barrier assembly and the casing to help loosen the o-ring fit. When pulling the barrier assembly out of the casing, the shaft and the impeller will normally be left in the casing. Occasionally the shaft will stick in the barrier. If this happens, make sure that the shaft does not drop out when the barrier assembly is removed or damage may result.



figure 12

8. Remove the impeller assembly and the shaft from the casing. *See figure 13.*

⚠ CAUTION: The shaft and impeller can be damaged if dropped.



figure 13

Disassembly

Power End (motor side)

⚠ WARNING: This pump should only be disassembled and assembled using the recommended procedures. The magnetic attraction is powerful enough to rapidly pull the motor end and the wet end together. ALWAYS use the jackscrews (item 14) to assemble/disassemble the pump. Do not place fingers between the mating surfaces of the motor and wet ends to avoid injuries. Keep the drive magnet and impeller assembly away from metal chips or particles.

1. Remove the two M8 hex nuts and lock washers (Items 21 & 22) & M8 hex head bolts and lock washers (Items 22 & 23). Pull the magnet drive hub (Item 8A) away from the shaft adapter (Item 8B). If the magnet drive hub is difficult to remove, you can thread (2) M8 hex head bolts (item 23) into the extra set of holes to use as jackscrews to pry it off. Make sure to apply equal turns to the bolts to pull the magnet drive hub off evenly. *See figure 14.*

Note: A cardboard tube is available to help protect the outer drive magnets from damage. If you do not have one of these tubes, please consult the spare parts list for ordering information.



figure 14

2. Remove the four motor adapter bolts and lock washers (items 16 & 16A). Pull the motor adapter (Item 9) off the motor. For IEC 160 frame, remove the motor adapter from the motor adapter flange (Item 10). *See figure 15.*

3. Remove the two set screws (Item 27) for NEMA frames or shaft bolt for IEC frames. *See figure 16.*

4. If replacing the motor for an IEC 160 frame, remove the four motor adapter flange bolts to remove the motor adapter flange.



figure 15

Examination

The first scheduled inspection should take place after the first three months or approximately after 2000 hours of run time. This is to insure that there is no damage from any solids or particulate, cavitation or run dry. Reinspect after six to twelve months depending on the results of the initial inspection.

Note: All pumps should be checked for leaks on a regular basis. If any leaks are detected, the pump should be repaired immediately.

Note: A new o-ring (item 12) will be required after pump inspection. If the drain flange is removed, replace the gasket (item 11A)



figure 16

1. Inspect the bushings (items 4A, 4B) - The silicon carbide parts will not wear under normal operation. Polishing on a silicon carbide surface is a normal occurrence and usually does not require replacement. Check for signs of melting around the perimeter of the bushings. Make sure that the spiral groove on the bushing ID is not plugged. Check for chips or cracks on the rear face. Check bushings for wear (*see figure 17*). If the bushings appear worn, follow the steps listed in the section “Replacing Wear Components, Impeller Bushings.”

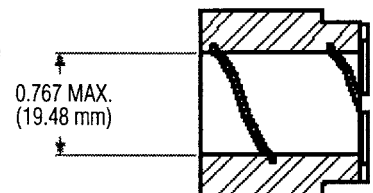

figure 17

2. Check for cracks or excessive wear on the shaft (item 5), impeller thrust ring (item 3A) and rear sealing ring (item 4C). Replace if cracked or excessively worn. *See figure 18.*

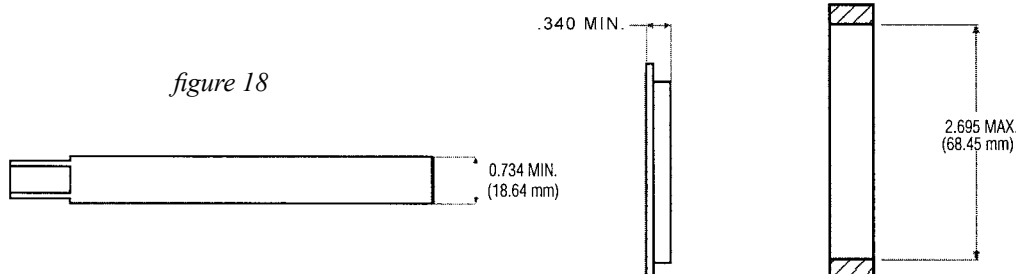

figure 18

3. Check for signs of deformation or melting in the shaft support (item 2) and the barrier liner where the pump shaft is positioned. Dry running the pump during its initial start-up or operation can cause heat-related damage to these components.
4. Inspect the casing liner. It is important that there are no abrasions or cuts deeper than .04 inch in the lining. These cracks may occur if the lining is corroded or abraded. Liner damage can usually be detected visually. Some hairline cracks require an electrostatic discharge tester to detect.
5. Locate the impeller vanes (impeller is item 3). Make certain that there are no obstructions. If there is an obstruction in any of the flow paths, then an imbalance may cause excessive wear on the pump shaft and impeller bushings.
6. Check the impeller drive assembly (item 4) for cracks or grooves larger than .02 inch. If a fluid comes in direct contact with the magnets, the magnets may swell, cause rubbing, and damage the barrier assembly (item 6).
7. Inspect the barrier assembly for signs of abrasion. Replace the barrier assembly if there are grooves or scratches that are deeper than .04 inch.

Replacing Wear Components

Use the following procedures to replace any wear components that are excessively worn, cracked or broken.

Shaft Support/Front Thrust Washer Removal

1. Remove the casing (item 1) from the base plate and piping.
2. Place the casing in an arbor press with ETFE lining side down.
3. Place arbor on the nose of the front shaft support (item 2) and carefully press the front shaft support out of casing. *See figure 19.*



figure 19

Installation of Replacement Support/Front Thrust Washer

1. Place the casing in an arbor press with the suction flange down.
2. Put front thrust washer into new shaft support.
3. Position the front shaft support in the bore of the casing suction and align the anti-rotation pins on the front shaft support with the blind holes in the casing.
4. Press evenly on the face of the plastic shaft support with a soft-faced arbor until the front shaft support is fully seated in the bore.

Impeller Thrust Ring

The impeller thrust ring is located in the front of the impeller shroud.

Removal

1. The impeller thrust ring (item 3A) is removed by grabbing the top of the ring with pliers and pulling with a twisting motion. Be careful not to damage the bore or face of the front impeller shroud. *See figure 20.*

Note: A new impeller thrust ring will be required after removal.



figure 20

Replacement

1. Place the impeller and impeller drive assembly (items 3,3A, 4,4A, 4B, 4C) on a table with the suction side facing up.
2. Position the replacement impeller thrust ring in the bore of the front shroud with the snap fit ridge towards the bottom of the bore. *See figure 21.* Align the anti-rotation flat on the impeller thrust ring with the flat in the impeller shroud.
3. Place the impeller and impeller drive assembly in an arbor press. Using a soft faced arbor, gently press the impeller thrust ring into place.

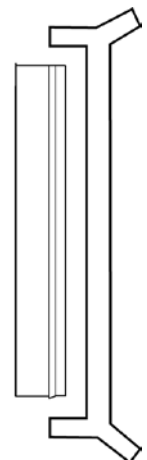

figure 21

Rear Sealing Ring

The rear sealing ring (item 4C) is located in the rear bore of the barrier assembly (item 6).

Removal

1. Place barrier (item 6) on a table with open side facing up.
2. Remove rear sealing ring by cutting it with a #18 straight edge X-Acto knife or similar blade & gently cut through the ring. Once cut, simply spread open and remove the ring from the barrier inner shaft boss. *See figure 22.*



figure 22

Replacement

1. Place barrier (item 6) in an arbor press with the open side facing up.
2. Place the rear sealing ring on the inner shaft boss of the barrier assembly, align the two tabs so they will fit in between the ribs located in the bottom of the barrier. *See figure 23.*
3. Gently press the ring into place evenly using an arbor press and a 2.68" (68 mm) diameter tool. **Note:** this is the minimum inner diameter for the tool to fit over the rear shaft boss. *See figures 24, 25, 26.*
4. Ring is fully seated when it "snaps" into the machined groove on the boss, roughly 3/8" (9.5 mm) from the top of the boss. *See figure 27.*



figure 23



figure 24



figure 25



figure 26



figure 27

Impeller Assembly Removal and Replacement

The impeller assembly can be replaced as required to change the impeller diameter or replace damaged or worn vanes.

Removal

1. Holding the impeller and impeller drive assembly (items 3,3A, 4,4A, 4B, 4C) by hand, place a 3/8-inch diameter rod (or a 3/8" ratchet extension) through the perforations in the bore of the impeller drive assembly (item 4).
2. While holding the impeller drive assembly tap on the rod with a hammer in several locations until the impeller assembly separates from the impeller drive assembly. *See figure 28.*



figure 28

Replacement

1. Place the impeller drive assembly in an arbor press with the rear sealing ring facing down.
2. Align the kidney-shaped drive pins on the impeller assembly with the kidney-shaped slots in the impeller drive assembly and press partially in by hand.
3. Complete installation by pressing the impeller assembly into the impeller drive assembly with an appropriate size arbor (be sure the arbor does not touch the impeller thrust ring, item 3A, use an arbor with a larger diameter than the eye of the impeller) until the back side of impeller rear shroud is flush with front face of impeller drive assembly. *See figure 29.*



figure 29

Impeller Bushings

Removal

1. Remove the impeller (item 3, 3A) according to the steps listed in the section Impeller Assembly, Removal.
2. Place the impeller drive assembly (items 4,4A, 4B, 4C) on an arbor press with the front of the impeller drive facing down.
3. Insert a 1" diameter arbor into the bore of the impeller drive assembly. *See figure 30.*
4. Press on face of rear impeller bushing until (2) bushings (item 4A) and (1) spacer (item 4B) have been removed. Check for excessive wear. *See figure 17.*
5. Check the impeller bore for signs of plastic melting or fretting wear.



figure 30

Replacement

1. Place a piece of tubing with an ID of 1 1/4" at the rear center of the impeller drive assembly. *See figure 31.* This tubing protects the lip that the bushing stops against. Place the impeller and impeller drive assembly in an arbor press with the suction side up.
2. Start the rear bushing into bore of impeller while lining up slots inside of the bushing with the drive ribs in the bore of the impeller. The interrupted face end of the bushing should be facing down. Press the bushing into the bottom of the impeller bore with a 1" diameter soft-faced arbor. The bushing slides in easily in the beginning of the bore, then becomes tighter. The bushing spacer can then be placed in the bore of the impeller on top of the first bushing.
3. The front bushing can then be installed as in step #2. The interrupted face of the bushing should be facing up. The front bushing will slide easily into place. A small portion of the rear impeller bushing projects out of the impeller bore. This is normal.
4. Reinstall the impeller according to the steps listed in the section Impeller Assembly, Replacement.



figure 31

Power End Reassembly

See section Assembly of Pumps without Motors, steps 1-7.

Pump End Reassembly

1. Take the pump casing (item 1) and lay it suction side down on a clean flat surface. *See figure 32.*
2. Insert the shaft's (item 5) rounded end into the round hole in the shaft support (item 2) in the casing. *See figure 33.*
3. Carefully place the impeller and impeller drive assembly (items 3A, 3,4,4A, 4B, 4C) on the pump shaft. *See figure 34.* Slowly rotate the impeller assembly and impeller drive assembly to ensure that there is no binding or dragging.
⚠ CAUTION: Do not use steel/iron tools near the magnets. These tools are attracted to the strong magnetic force and could damage them upon impact.
4. Install a new o-ring (item 12) in the barrier assembly's (item 6) o-ring groove. Lubricate the o-ring with a suitable lubricant. *See figure 35.*
5. Slide the barrier assembly over the shaft and impeller assembly. Align the square hole in the barrier assembly with the square end of the shaft. Press down on the barrier assembly until it is fully seated. *See figure 36.*

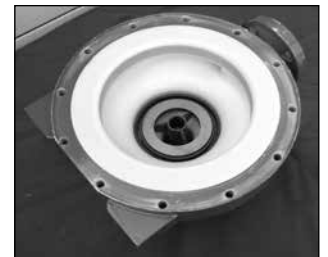

figure 32

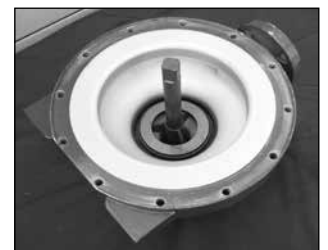

figure 33



figure 34



figure 35



figure 36

6. Place the rounded edge of the clamp ring (Item 7) over the barrier assembly and position on the rear face of the casing. Make sure to align the flat on the bottom of the clamp ring with the flat on the bottom of the casing. Attach the clamp ring with (12) 3/8" socket head cap screws (item 13). Tighten evenly around circumference. Torque the screws to 35 ft-lbs (47 N-m) unlubricated. See figure 37.
7. Using a 3/4" socket, turn the (3) jackscrews (item 14) clockwise until the heads touch the motor adapter (item 9).
8. Carefully slide the wet end towards the motor adapter until it touches the jackscrews (there will be some magnetic attraction). See figure 38.
9. Slowly and evenly turn the jackscrews counterclockwise to allow the wet end to slowly slide into the motor adapter. When the jackscrews are fully retracted, lift the wet end slightly and slide it onto the motor adapter's locating flange.
10. Bolt the wet end to the motor adapter by re-installing the (4) 1/2" hex head cap screws (item 15) and torque evenly to 75 ft-lbs (102 N-m).

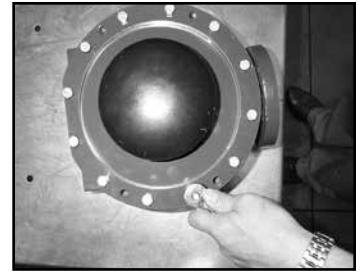

figure 37

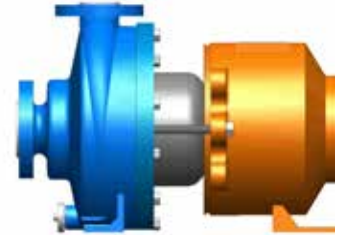

figure 38

TROUBLESHOOTING

NO OR INSUFFICIENT DISCHARGE

- Air leaks in suction piping.
- Pump not primed.
- Discharge head higher than anticipated.
- Closed valve.
- Viscosity or specific gravity too high (magnets uncoupled).
- Suction lift too high or insufficient NPSH.
- Clogged suction line or impeller vanes.
- Motor rotation incorrect (correct rotation when viewed from the fan end is clockwise).

INSUFFICIENT PRESSURE

- Air or gas in liquid.
- Impeller diameter too small.
- System head lower than anticipated.
- Motors speed insufficient (too low) or motor rotation incorrect (correct rotation when viewed from the fan end is clockwise).

LOSS OF PRIME

- Leaking suction line.
- Foot valve or suction opening not submerged enough.
- Foot valve too small or leaking.
- Air or gas in liquid.
- Foreign matter in impeller.
- Leaking valve. Suction lift too high or insufficient NPSH.

EXCESSIVE POWER CONSUMPTION

- Head lower than rating.
- Excessive flow.
- Specific gravity or viscosity too high.

VIBRATION/NOISE

- Loose magnet.
- Drive magnet rubbing.
- Pump cavitation from improper suction or feed.
- Motor or piping not properly secured.
- Foreign object in impeller.

IMPORTANT NOTICE

U.S. Export Administration Regulations, pursuant to ECCN 2B350, prohibit the export or reexport to certain enumerated countries of sealless centrifugal pumps in which all wetted materials are constructed from fluoropolymers without first applying for and obtaining a license from the U.S. Bureau of Industry and Security (BIS). This affects all Finish Thompson magnetic-drive pumps constructed from PVDF or lined with ETFE. Please contact the BIS (www.bis.doc.gov) or Finish Thompson with questions regarding the Regulations or a list of the countries to which they apply.

CHEMICAL REACTION DISCLAIMER

The user must exercise primary responsibility in selecting the product's materials of construction, which are compatible with the fluid(s) that come(s) in contact with the product. The user may consult Finish Thompson, Inc. (manufacturer) and a manufacturer's representative/distributor agent to seek a recommendation of the product's material of construction that offers the optimum available chemical compatibility.

However neither manufacturer nor agent shall be liable for product damage or failure, injuries, or any other damage or loss arising out of a reaction, interaction or any chemical effect that occurs between the materials of the product's construction and fluids that come into contact with the product's internals.

HELPFUL HINTS

Do not pump liquids containing ferrous metal fines.

If magnets de-couple, stop the pump immediately. The rare earth magnets used in this pump are more resistant to demagnetization, but operating the pump with the magnets de-coupled will eventually weaken the magnets.

A power monitor is strongly recommended. This device will help protect the pump against abnormal operating conditions such as dry running, magnet de-coupling, cavitation, etc.

Power monitors are required and must be used with all ATEX certified pumps.

The setting of the drive magnet dimension is critical. Failure to properly set the dimension may result in de-coupling or damage to pump components.

Do not use mismatched drive magnet assemblies (impeller drive magnet and the outer drive magnet assembly). The drives are marked with either an "A" or "B". Use only components with the same drive letter designation. A serial number plate is attached to the motor adapter section.

Call our toll free Technical Service Hot Line, 1-800-888-3743, if you have any questions regarding product operation or repair.

ORDERING SPARE PARTS

Spare parts can be ordered from your local distributor. Always refer to the pump model number to avoid error.

OTHER FINISH THOMPSON PUMP PRODUCTS

Drum Transfer Pumps are available in sanitary construction, Stainless steel, polypropylene and CPVC. Flows to 40 gpm, Discharge heads to 300 feet and viscosities to 100,000 cps.

Portable Mixers for turbine mixing and blending handle viscosities to 1,000 cP with gentle, non-vortexing circulation. Available in 316 stainless steel construction.

Centrifugal Pumps in polypropylene, PVDF, stainless steel, or Hastelloy C come with a wide variety of sealing materials. Flows to 330 gpm, discharge heads to 275 feet, and temperatures to 220°F (104°C)

For more information contact Finish Thompson Inc. Call our toll free Technical Service Hot Line, 1-800-888-3743, if you have any questions regarding product operation or repair.

UC EXPLODED VIEW PARTS DIAGRAM

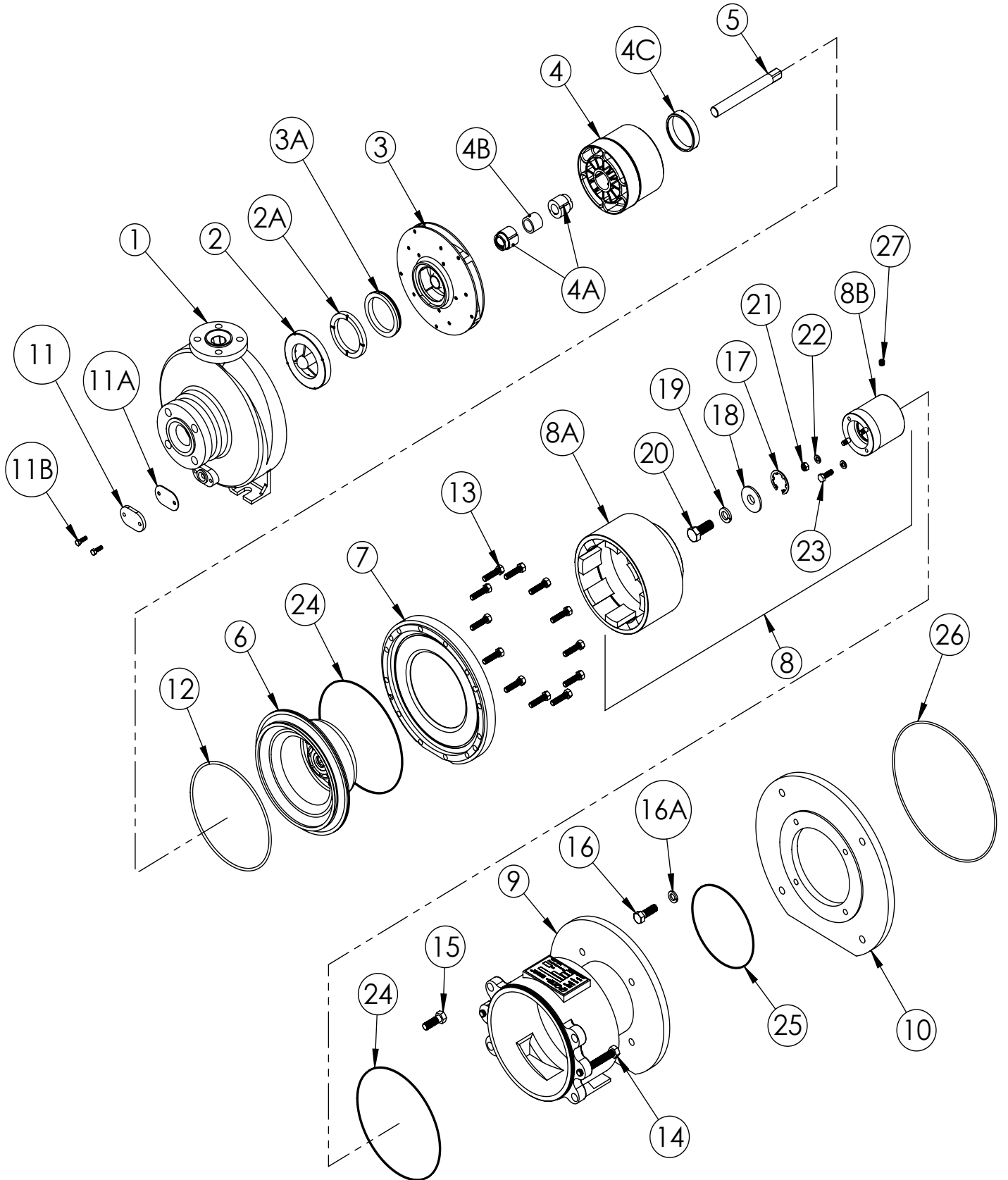

UC Spare Parts

Item	Qty	Description	Part Number
1	1	Casing - ETFE-lined Cast Ductile Iron	
		UC1516	A103145
		UC1518	A103146
		UC326	A103147
2	1	Front Shaft Support Only (2A sold separately)	
		ETFE	M102206
2A	1	Front Thrust Ring Only	
		Silicon Carbide - all models except UC1516 w/ SiC impeller thrust ring option	J103659
		Silicon Carbide - UC1516 pumps w/ silicon carbide impeller thrust ring option only	J104174
3	1	Impeller Assembly - Includes Item 3A	
		ETFE	See charts on pg. 23
3A	1	Impeller Thrust Ring	
		For UC1516 - Fluorosint®	J103900-1
		For UC1518 - Fluorosint®	106950
		For UC326 - Fluorosint®	J103900-2
		For UC1516 - Silicon Carbide	J104172
		For UC1518 - Silicon Carbide	J104171
		For UC326 - Silicon Carbide	J104173
	1	Impeller Thrust Ring O-Ring (Not Shown) - For Use With Silicon Carbide Thrust Ring Option Only	
		UC1516 - PTFE Encapsulated FKM	108037
		UC1516 - FKM	J104186
		UC1516 - EPDM	J104187
		UC1518 / UC326 - PTFE Encapsulated FKM	108038
		UC1518 / UC326 - FKM	J104189
		UC1518 / UC326 - EPDM	J104190
4	1	Impeller Drive Hub	
		"A" magnet - ETFE	108476-1
		"B" magnet - ETFE	108476-2
4A	2	Bushing	
		Silicon carbide	J103653-1
		Carbon	J103653-2
		Silicon carbide with Dri-Coat diamond-like coating	J103653-3
4B	1	Bushing Spacer	
		PTFE - UC1516	M102207-2
		PTFE - UC1518 / UC326	M102207-1
4C	1	Rear Sealing Ring	
		PTFE	108482
5	1	Shaft	
		Silicon carbide	J103643
		Silicon carbide with Dri-Coat diamond-like coating	J103643-1
6	1	Barrier Assembly - Includes Item 4C	
		UC1516 / UC326 - ETFE/FRP	108483-1
		UC1518 - ETFE/FRP	108483-2
7	1	Clamp Ring	
		Painted steel	M102184

Item	Qty	Description	Part Number
8	1	Outer Drive Assembly w/ Set Screw - Painted Ductile Iron/Steel	
		143-145TC "A" magnet	108433-1
		182-184TC "A" magnet	108433-2
		213-215TC "A" magnet	108433-3
		182-184TC "B" magnet	108436-1
		213-215TC "B" magnet	108436-2
		254-256TC "B" magnet	108436-3
		IEC 90 B14 "A" magnet	108433-4
		IEC 110/112 B14 "A" magnets	108433-5
		IEC 132 B5 "A" magnets	108433-6
		IEC 132 B5 "B" magnets	108436-4
IEC 160 B5 "B" magnets	108436-5		
8A	1	Outer Drive Magnet Hub - Painted Ductile Iron	
		"A" magnet	108350
		"B" magnet	108432
8B	1	Shaft Adapter - Painted Steel (Includes Retaining Ring & Set Screws For NEMA Frames)	
		NEMA 143-145TC	108547-1
		NEMA 182-184TC	108547-2
		NEMA 213-215TC	108547-3
		NEMA 254-256TC	108547-4
		IEC 90 B14	108547-5
		IEC 100-112 B14	108547-6
		IEC 132 B5	108547-7
IEC 160 B5	108547-8		
9	1	Motor Adapter - Painted Ductile Iron	
		NEMA 143-145TC	108429-1
		NEMA 143-145TC with non-sparking ring (ATEX)	108583-1
		NEMA 182-184TC, 213-215TC, 254-256TC	108636
		NEMA 182-184TC, 213-215TC, 254-256TC with non-sparking ring (ATEX)	108584-1
		IEC 90 B14	108429-2
		IEC 90 B14 with non-sparking ring (ATEX)	108583-2
		IEC 100-112 B14	108429-3
		IEC 100-112 B14 with non-sparking ring (ATEX)	108583-3
		IEC 132 B5	107935
		IEC 132 B5 with non-sparking ring (ATEX)	108584-2
		IEC 160 B5	108636
IEC 160 B5 with non-sparking ring (ATEX)	108584-1		
10	1	Motor Adapter Flange - Painted Steel	
		IEC 160 B5 only	107968
11	1	Drain Cap	
		304SS	A102666
11A	1	Drain Cap Gasket	
		Gylon	J103674
12	1	Housing O-ring	
		EPDM (UC1516 & UC326)	J103667
		FKM (UC1516 & UC326)	J103668
		Aflas (UC1516 & UC326)	105430
		EPDM (UC1518)	J103669
		FKM (UC1518)	J103670
Aflas (UC1518)	105431		
24	2	Vapor Protection O-ring - Buna	
		For barrier/clamp ring & clamp ring/motor adapter	108585

Item	Qty	Description	Part Number
25	1	Motor End Vapor Protection O-ring - Buna	
		NEMA 143-145TC	106549
		NEMA 182-184TC, 213-215TC, 254-256TC	108165
		IEC 90 B14	108937
		IEC 100-112 B14	108588
		IEC 132 B5	108589
26	1	Motor Adapter Flange Vapor Protection O-ring - Buna	
		IEC 160 B5 only	108594
Hardware - All Models			
11B	2	Drain Cap Hex Head Cap Screw - Stainless Steel	
		1/4-20 x 3/4	J100320
13	12	Casing Hex Head Cap Screw - Stainless Steel	
		3/8-16 x 1-1/2	J103207
14	2	Jack Screws Hex Head Cap Screw- Stainless Steel	
		1/2-13 x 3-1/2	J103773
15	4	Motor Adapter Hex Head Cap Screw - Stainless Steel	
		1/2-13 x 1-1/2	J101858
16	4	Motor Adapter Hex Head Cap Screw - Stainless Steel	
		NEMA 143-145TC - 3/8-16 x 1-1/4	J103118
		NEMA 182-184TC, 213-215TC, 254-256TC - 1/2-13 x 1-1/2	J101858
		IEC 90 B14, IEC 100-112 B14 - M8-1.25 x 25mm	J103662
		IEC 132 B5*	N/A
16A	4	Motor Adapter Lock Washer - Stainless Steel	
		NEMA 143-145TC - 3/8"	J100115
		NEMA 182-184TC, 213-215TC, 254-256TC - 1/2"	J101023
		IEC 90 B14, IEC 100-112 B14 - 5/16"	J102282
		IEC 132 B5*	N/A
17	1	Retaining Ring - Steel	
		NEMA 143-145TC	105709
		NEMA 182-184TC	105710
		NEMA 213-215TC	106454
		NEMA 254-256TC	106718
		IEC 90 B14	105712
		IEC 100-112 B14	105710
		IEC 132 B5	106468
		IEC 160 B5	106714
18	1	Shaft Washer (IEC Motors Only) - Stainless Steel	
		IEC 90 B14	108581-1
		IEC 100-112 B14	108580
		IEC 132 B5	108581-2
		IEC 160 B5	108581-3
19	1	Shaft Lock Washer - Stainless Steel (IEC Motors Only)	
		IEC 90 B14 - 5/16"	J102282
		IEC 100-112 B14	N/A
		IEC 132 B5 - M12	106503
		IEC 160 B5 - M16	107924

20	1	Shaft Bolt - Stainless Steel (IEC Motors Only)	
		IEC 90 B14, IEC 100-112 B14 - M8-1.25 x 25mm hex head cap screw	J103662
		IEC 100-112 B14 - M10-1.5 x 35mm fillister head cap screw	108582
		IEC 132 B5 - M12-1.75 x 30mm hex head cap screw	106507
		IEC 160 B5 - M16-2 x 35mm hex head cap screw	108270
21	2	Shaft Adapter Hex Nut - Stainless Steel	
		M8	J103930
22	4	Shaft Adapter Lock Washer - Stainless Steel	
		5/16"	J102282
23	2	Shaft Adapter Hex Head Cap Screw - Stainless Steel	
		M8-1.25 x 25mm	J103662
27	2	Shaft Adapter Set Screw - Stainless Steel	
		3/8-16 x 3/8 knurled cup point	J101084
28	1	Outer Drive Protection Tube	
		Cardboard tube (for assembly use only)	108952

*For IEC 132 B5 motors, hardware to attach the motor (not shown) to the motor adapter (Item 9) is to be supplied by the customer due to variations in B5 frame motors.

**For IEC 160 B5 pumps, these bolts attach the motor adapter (Item 9) to supplied motor adapter flange (Item 10). Hardware to attach motor (not shown) to motor adapter flange (item 10) is to be supplied by the customer due to variations in B5 frame motors.

UC1516 Impeller Part Numbers

with Fluorosint® Thrust Ring	
Imp. Dia.	Part Number
6 3/8"	A103166-1
6 1/4"	A103166-2
6 1/8"	A103166-3
6"	A103166-4
5 7/8"	A103166-5
5 3/4"	A103166-6
5 5/8"	A103166-7
5 1/2"	A103166-8
5 3/8"	A103166-9
5 1/4"	A103166-10
5 1/8"	A103166-11
5"	A103166-12
4 7/8"	A103166-13
4 3/4"	A103166-14
4 5/8"	A103166-15
4 1/2"	A103166-16
4 3/8"	A103166-17
4 1/4"	A103166-18
4 1/8"	A103166-19
4"	A103166-20

with SiC Thrust Ring and PTFE Encapsulated O-ring	
Imp. Dia.	Part Number
6 3/8"	106555
6 1/4"	106555-1
6 1/8"	106555-2
6"	106555-3
5 7/8"	106555-4
5 3/4"	106555-5
5 5/8"	106555-6
5 1/2"	106555-7
5 3/8"	106555-8
5 1/4"	106555-9
5 1/8"	106555-10
5"	106555-11
4 7/8"	106555-12
4 3/4"	106555-13
4 5/8"	106555-14
4 1/2"	106555-15
4 3/8"	106555-16
4 1/4"	106555-17
4 1/8"	106555-18
4"	106555-19

UC326 Impeller Part Numbers

with Fluorosint® Thrust Ring	
Imp. Dia.	Part Number
6 3/8"	A103165-1
6 1/4"	A103165-2
6 1/8"	A103165-3
6"	A103165-4
5 7/8"	A103165-5
5 3/4"	A103165-6
5 5/8"	A103165-7
5 1/2"	A103165-8
5 3/8"	A103165-9
5 1/4"	A103165-10
5 1/8"	A103165-11
5"	A103165-12
4 7/8"	A103165-13
4 3/4"	A103165-14
4 5/8"	A103165-15
4 1/2"	A103165-16
4 3/8"	A103165-17
4 1/4"	A103165-18

with SiC Thrust Ring and PTFE Encapsulated O-ring	
Imp. Dia.	Part Number
6 3/8"	106557
6 1/4"	106557-1
6 1/8"	106557-2
6"	106557-3
5 7/8"	106557-4
5 3/4"	106557-5
5 5/8"	106557-6
5 1/2"	106557-7
5 3/8"	106557-8
5 1/4"	106557-9
5 1/8"	106557-10
5"	106557-11
4 7/8"	106557-12
4 3/4"	106557-13
4 5/8"	106557-14
4 1/2"	106557-15
4 3/8"	106557-16
4 1/4"	106557-17

UC1518 Impeller Part Numbers

with Fluorosint® Thrust Ring	
Imp. Dia.	Part Number
8 1/8"	A103164-1
8"	A103164-2
7 7/8"	A103164-3
7 3/4"	A103164-4
7 5/8"	A103164-5
7 1/2"	A103164-6
7 3/8"	A103164-7
7 1/4"	A103164-8
7 1/8"	A103164-9
7"	A103164-10
6 7/8"	A103164-11
6 3/4"	A103164-12
6 5/8"	A103164-13
6 1/2"	A103164-14
6 3/8"	A103164-15
6 1/4"	A103164-16
6 1/8"	A103164-17
6"	A103164-18

with SiC Thrust Ring and PTFE Encapsulated O-ring	
Imp. Dia.	Part Number
8 1/8"	106556
8"	106556-1
7 7/8"	106556-2
7 3/4"	106556-3
7 5/8"	106556-4
7 1/2"	106556-5
7 3/8"	106556-6
7 1/4"	106556-7
7 1/8"	106556-8
7"	106556-9
6 7/8"	106556-10
6 3/4"	106556-11
6 5/8"	106556-12
6 1/2"	106556-13
6 3/8"	106556-14
6 1/4"	106556-15
6 1/8"	106556-16
6"	106556-17



FINISH THOMPSON INC.

921 Greengarden Road • Erie, PA 16501-1591 U.S.A.

Ph 814-455-4478 • Fax 814-455-8518

Email fti@finishthompson.com • www.finishthompson.com



Part Number 108735, R2 8/19/2014

Literature ID Number FT00-811