

KC & VKC SERIES CURVEBOOK

Catalog ID #FT01-833E
Rev. 5, 1-27-09

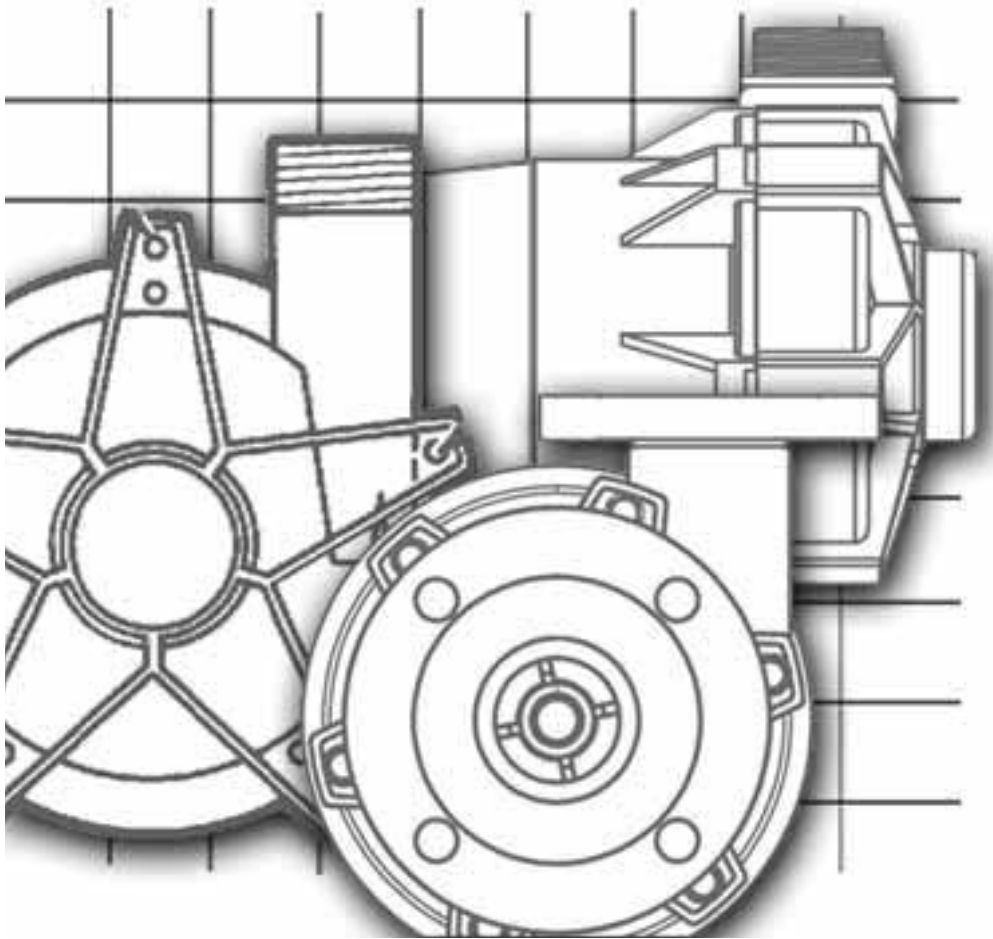

FINISH THOMPSON INC.

921 Greengarden Road • Erie, PA 16501-1591 U.S.A.
Ph 814-455-4478 • Fax 814-455-8518

Email fti@finishthompson.com • www.finishthompson.com

TABLE OF CONTENTS

MODEL KC 3,4, 5 SERIES

3450 rpm, 6Hz 1" FNPT x 1/2" MNPT -----	4
2850 rpm, 50Hz, 1" FNPT X 1/2" MNPT -----	5

MODEL KC/VKC 5.5/6 SERIES

3450 rpm, 60 Hz, 1" FNPT X 3/4" MNPT-----	6
1725 rpm, 60 Hz, 1" FNPT X 3/4" MNPT-----	7
2900 rpm, 50 Hz, 1" FNPT X 3/4" MNPT-----	8
1450 rpm, 50 Hz, 1" FNPT X 3/4" MNPT-----	9

MODEL KC/VKC 6H Series

3450 rpm, 60 Hz, 1" FNPT X 3/4" MNPT -----	10
1725 rpm, 60 Hz, 1" FNPT X 3/4" MNPT-----	11
2900 rpm, 50 Hz, 1" FNPT X 3/4" MNPT-----	12
1450 rpm, 50 Hz, 1" FNPT X 3/4" MNPT-----	13

MODEL KC/VKC 7 Series

3450 rpm, 60 Hz, 1-1/2" FNPT X 1" MNPT -----	14
1725 rpm, 60 Hz, 1-1/2" FNPT X 1" MNPT -----	15
2900 rpm, 50 Hz, 1-1/2" FNPT X 1" MNPT -----	16
1450 rpm, 50 Hz, 1-1/2" FNPT X 1" MNPT -----	17

MODEL KC/VKC 8/10 SERIES

3450 rpm, 60 Hz, 1-1/2" FNPT X 1" MNPT -----	18
1725 rpm, 60 Hz, 1-1/2" FNPT X 1" MNPT -----	19
2900 rpm, 50 Hz, 1-1/2" FNPT X 1" MNPT -----	20
1450 rpm, 50 Hz, 1-1/2" FNPT X 1" MNPT -----	21

MODEL KC11 SERIES

3450 rpm, 60 Hz, 1-1/2" FNPT X 1-1/4" MNPT-----	22
1725 rpm, 60 Hz, 1-1/2" FNPT X 1-1/4" MNPT-----	23
2900 rpm, 50 Hz, 1-1/2" FNPT X 1-1/4" MNPT-----	24
1450 rpm, 50 Hz, 1-1/2" FNPT X 1" MNPT -----	25

MODEL KC22/32 SERIES

Open, 3450 rpm, 60 Hz, 2" FNPT (3" f ange) x 2" MNPT (2" f ange) -----	26
Open, 1725 rpm, 60 Hz, 2" FNPT (3" f ange) x 2" MNPT (2" f ange) -----	27
Open, 2900 rpm, 60 Hz, 2" FNPT (3" f ange) x 2" MNPT (2" f ange) -----	28
Open, 1450 rpm, 60 Hz, 2" FNPT (3" f ange) x 2" MNPT (2" f ange) -----	29
Closed, 3450 rpm, 60 Hz, 2" FNPT (3" f ange) x 2" MNPT (2" f ange) -----	30
Closed, 1725 rpm, 60 Hz, 2" FNPT (3" f ange) x 2" MNPT (2" f ange) -----	31
Closed, 2900 rpm, 50 Hz, 2" FNPT (3" f ange) x 2" MNPT (2" f ange) -----	32
Closed, 1450 rpm, 50 Hz, 2" FNPT (3" f ange) x 2" MNPT (2" f ange) -----	33

MULTI STAGE SERIES

3450 rpm, 60 Hz, 1-1/2" FNPT x 1" MNPT -----	34
1725 rpm, 60 Hz, 1-1/2" FNPT x 1" MNPT -----	35
2900 rpm, 50 Hz, 1-1/2" FNPT x 1" MNPT -----	36
1450 rpm, 50 Hz, 1-1/2" FNPT x 1" MNPT -----	37



KC/KC SERIES
MODELS KC3, 4 & 5
PERFORMANCE CURVE

MODELS KC3/4/5
3450 rpm, 60 Hz
Suction: 1" FNPT
Discharge: 1/2" MNPT

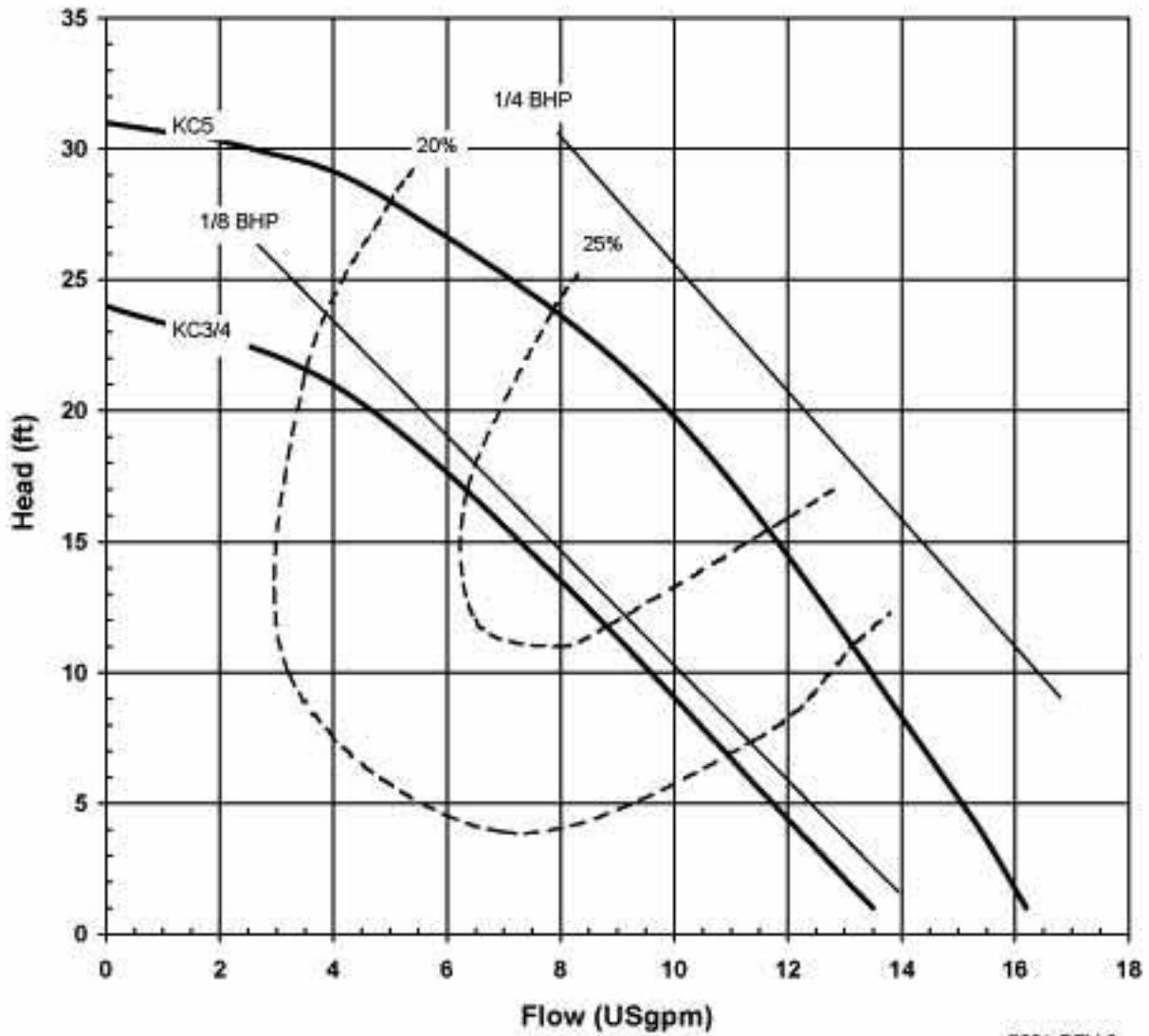

2021 REV 0
01/01/09



KC SERIES
MODELS KC 3, 4 & 5
PERFORMANCE CURVE

MODELS KC3/4/5

2850 rpm, 50 Hz
Suction: 1" FNPT
Discharge: 1/2" MNPT

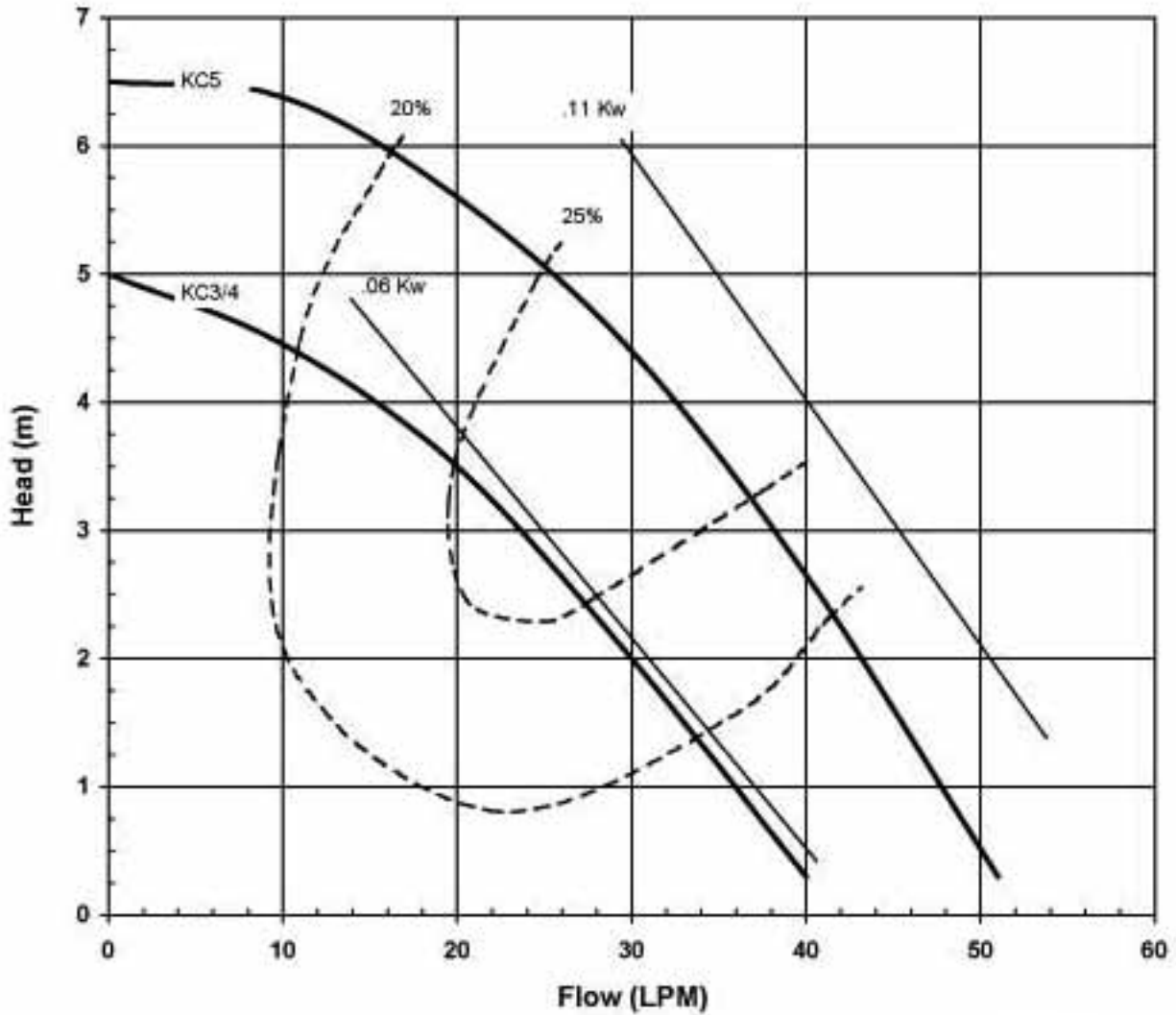

2022 REV 0
01/01/2009



KC/VKC SERIES
MODELS KC/VKC 5.5 & 6
PERFORMANCE CURVE

MODEL KC5.5/6
VKC5.5/6
3450 rpm, 60 Hz
Suction: 1" FNPT
Discharge: 3/4" MNPT

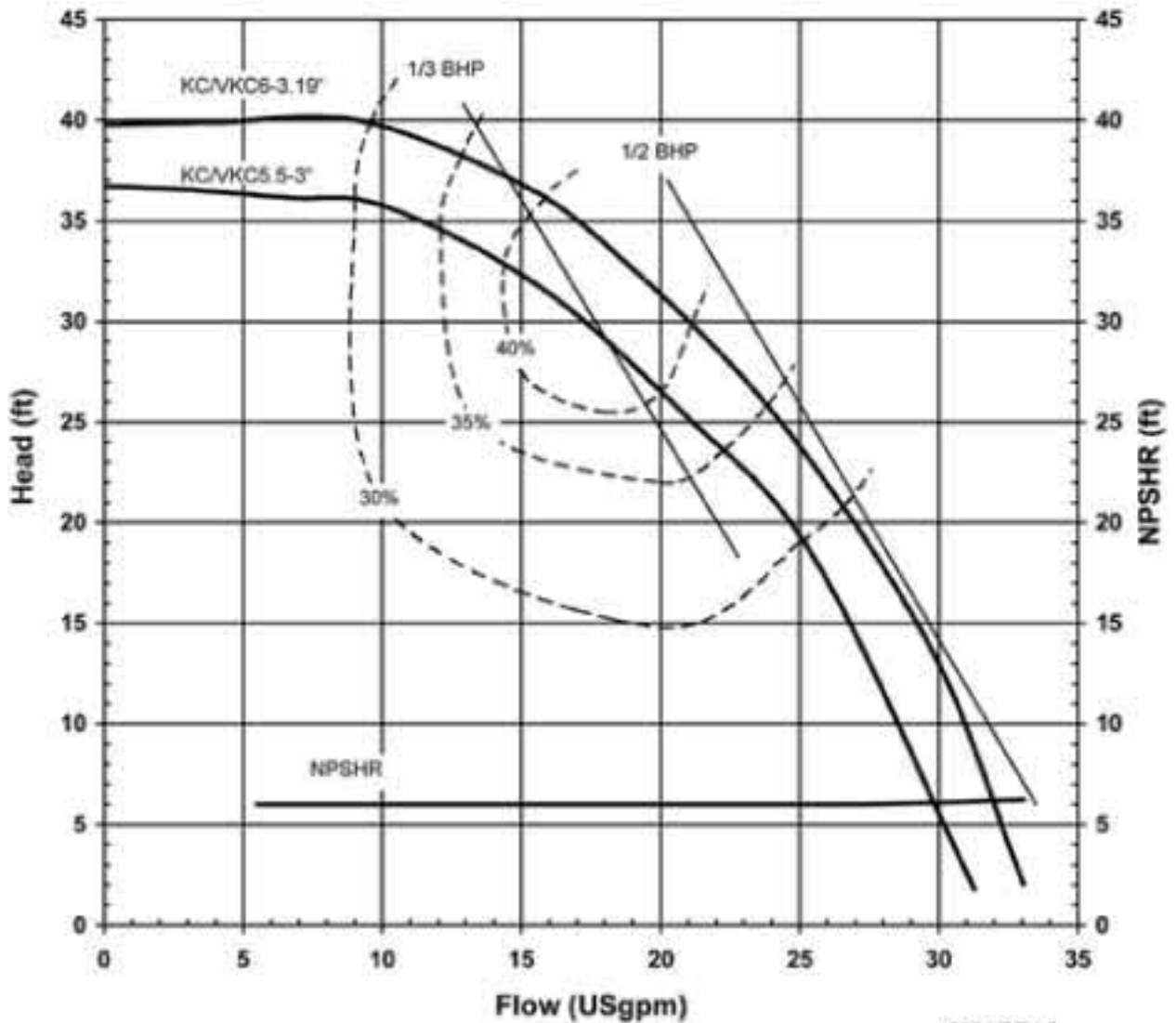

2001 REV 0
01/01/2009



KC/VKC SERIES
MODELS KC/VKC 5.5 & 6
PERFORMANCE CURVE

MODEL KC5.5/6
VKC 5.5/6
1725 rpm, 60 Hz
Suction: 1" FNPT
Discharge: 3/4" MNPT

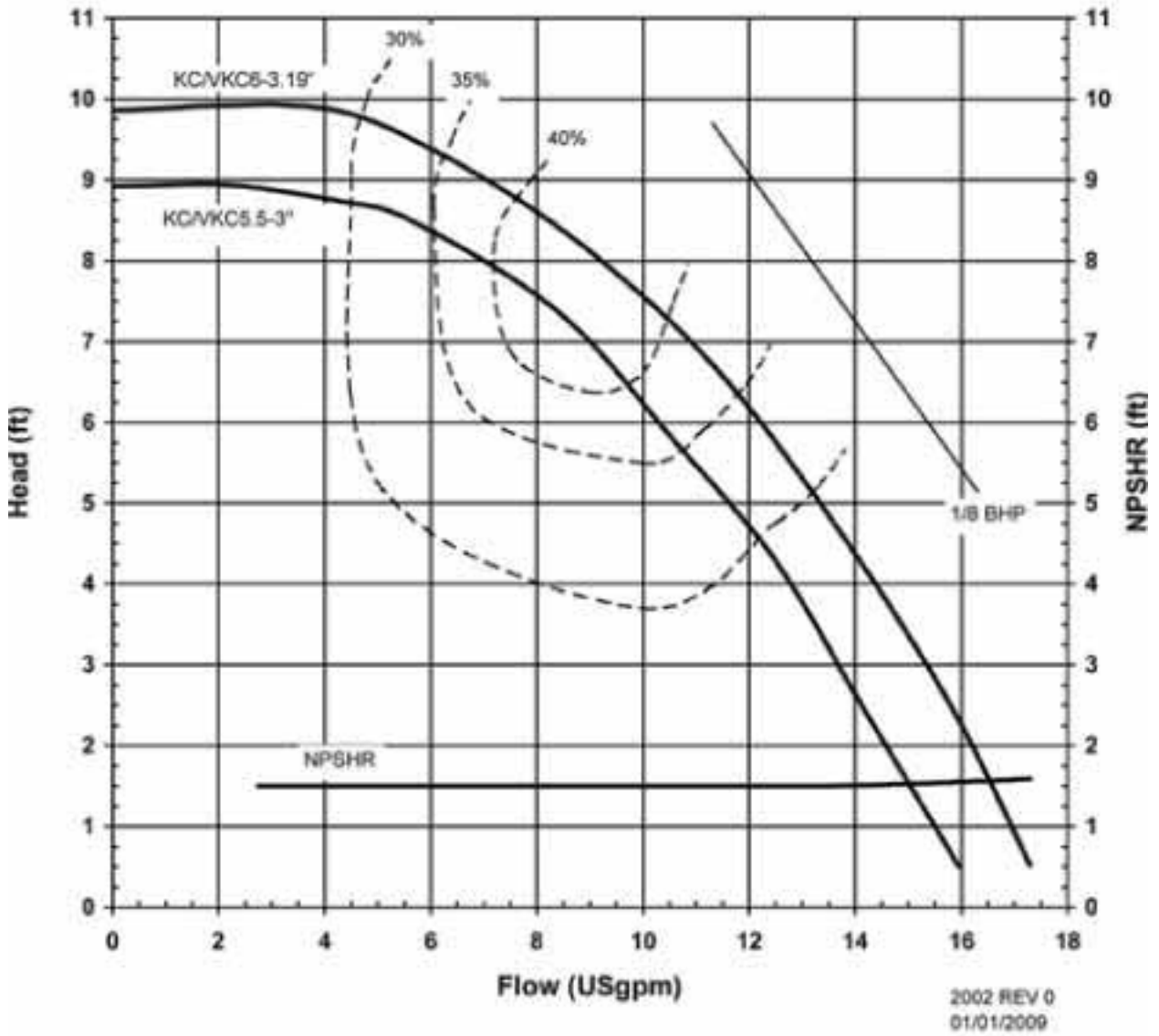



KC/VKC SERIES
MODELS KC/VKC 5.5 & 6
PERFORMANCE CURVE

MODEL KC5.5/6
VKC5.5/6
2900 rpm, 50 Hz
Suction: 1" FNPT
Discharge: 3/4" MNPT

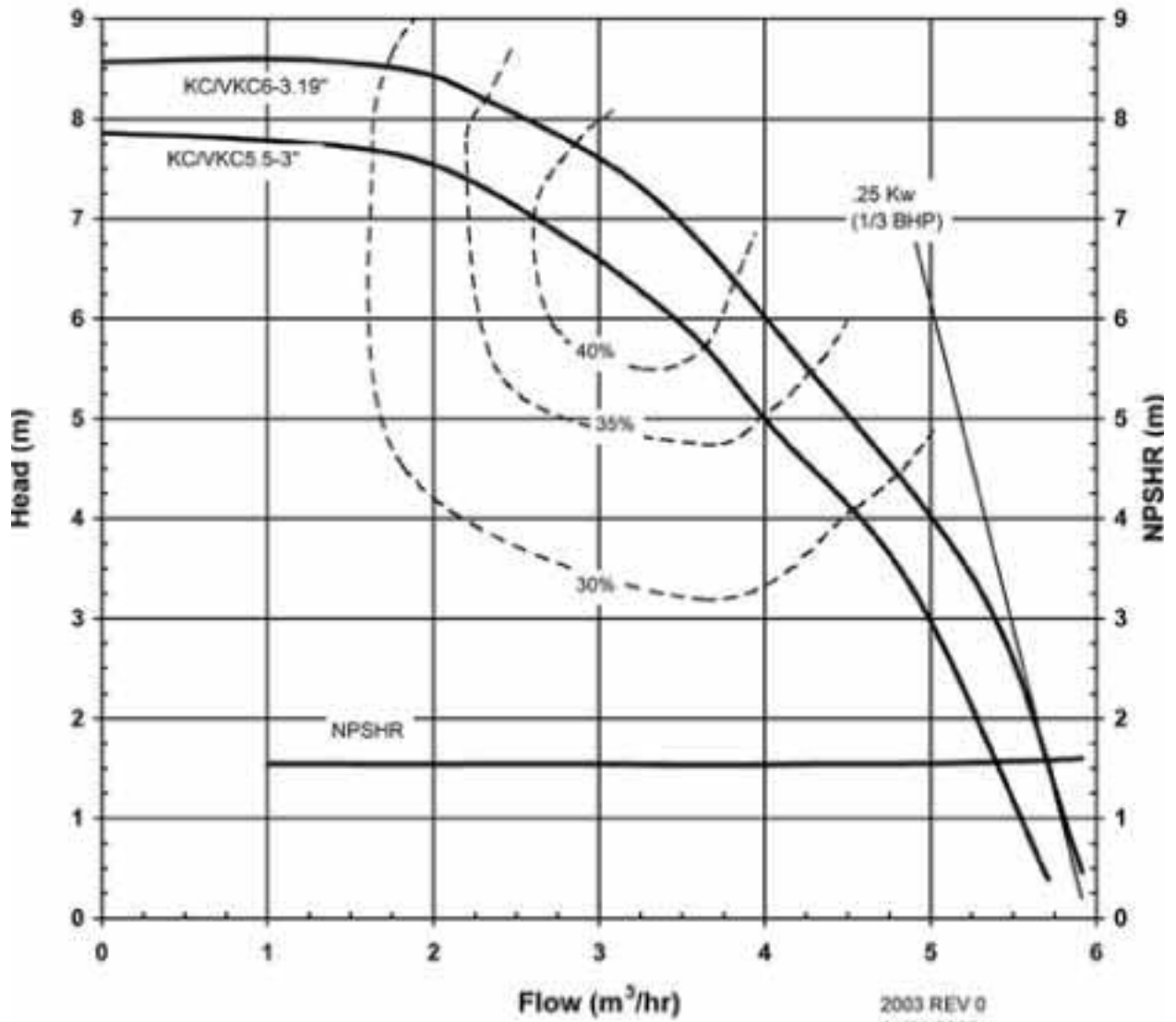

2003 REV 0
01/01/2009



KC/VKC SERIES
MODEL KC/VKCS 5.5 & 6
PERFORMANCE CURVE

MODEL KC5.5/6
VKC5.5/6
1450 rpm, 50 Hz
Suction: 1" FNPT
Discharge: 3/4" MNPT

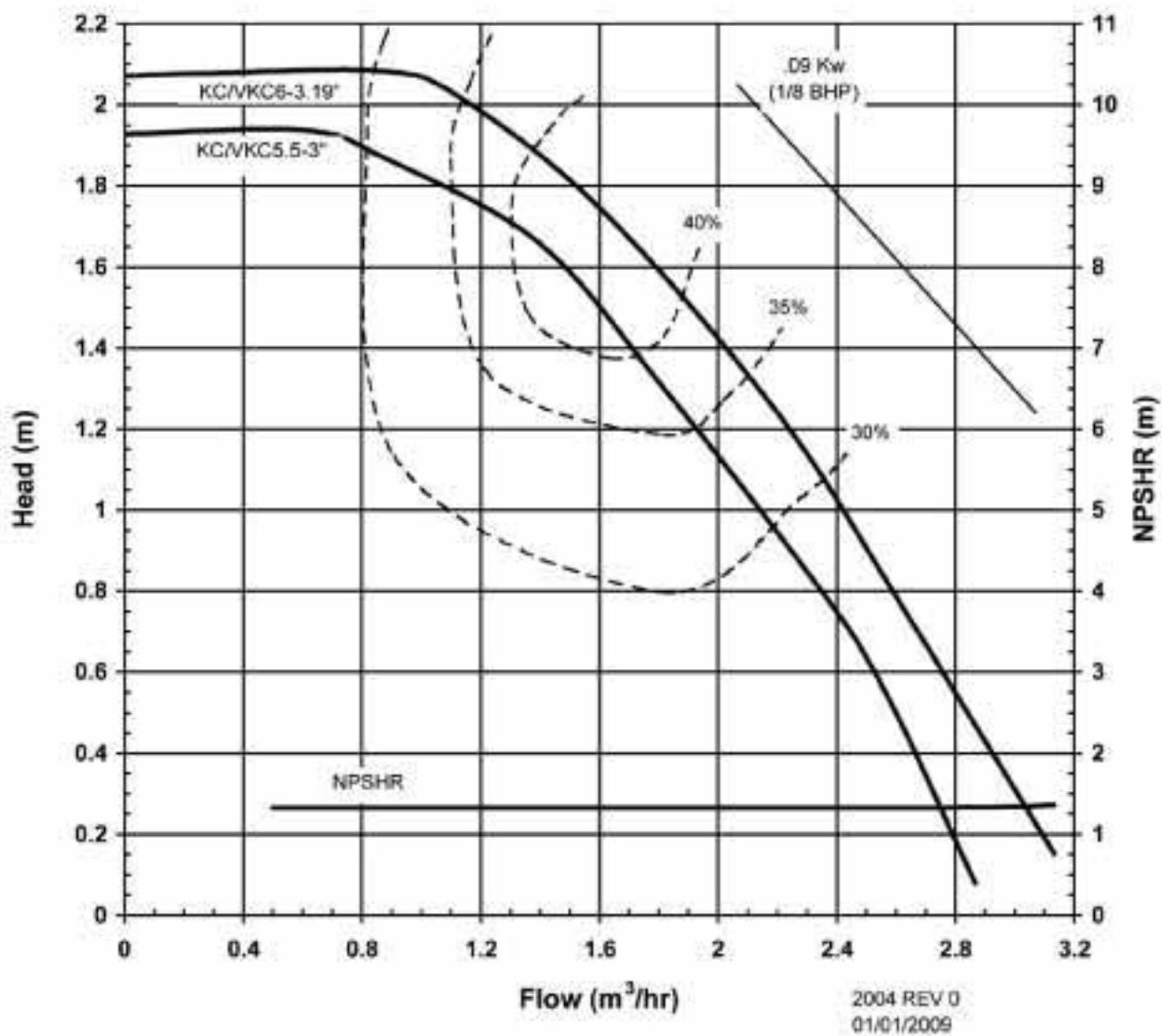



KC/VKC SERIES
MODELS KC/VKC 6H
PERFORMANCE CURVE

**MODEL KC6H
VKC6H**
3450 rpm, 60 Hz
Suction: 1" FNPT
Discharge: 3/4" MNPT

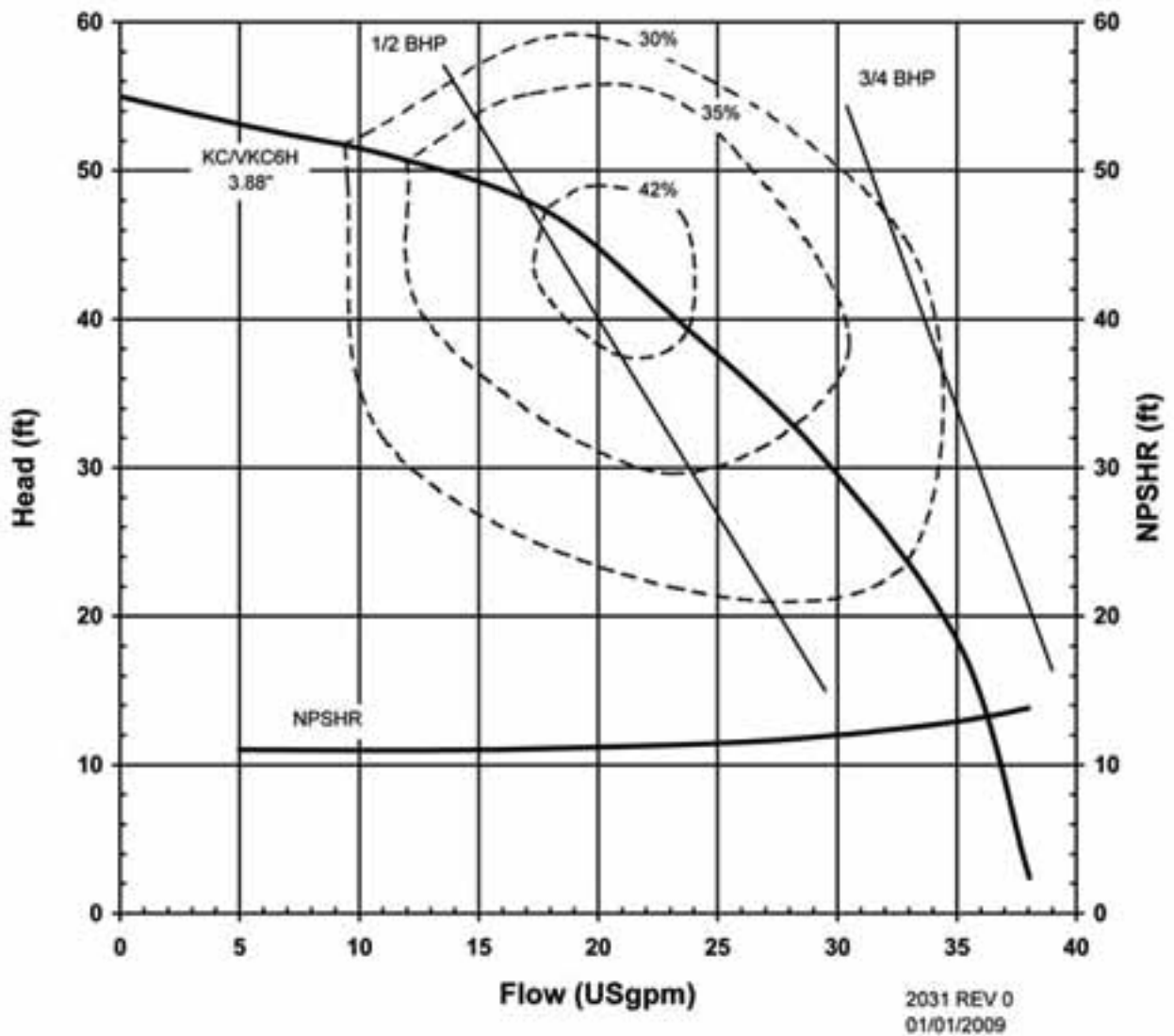



KC/VKC SERIES
MODELS KC/VKC 6H
PERFORMANCE CURVE

MODEL KC6H
VKC6H

1725 rpm, 60 Hz
Suction: 1" FNPT
Discharge: 3/4" MNPT

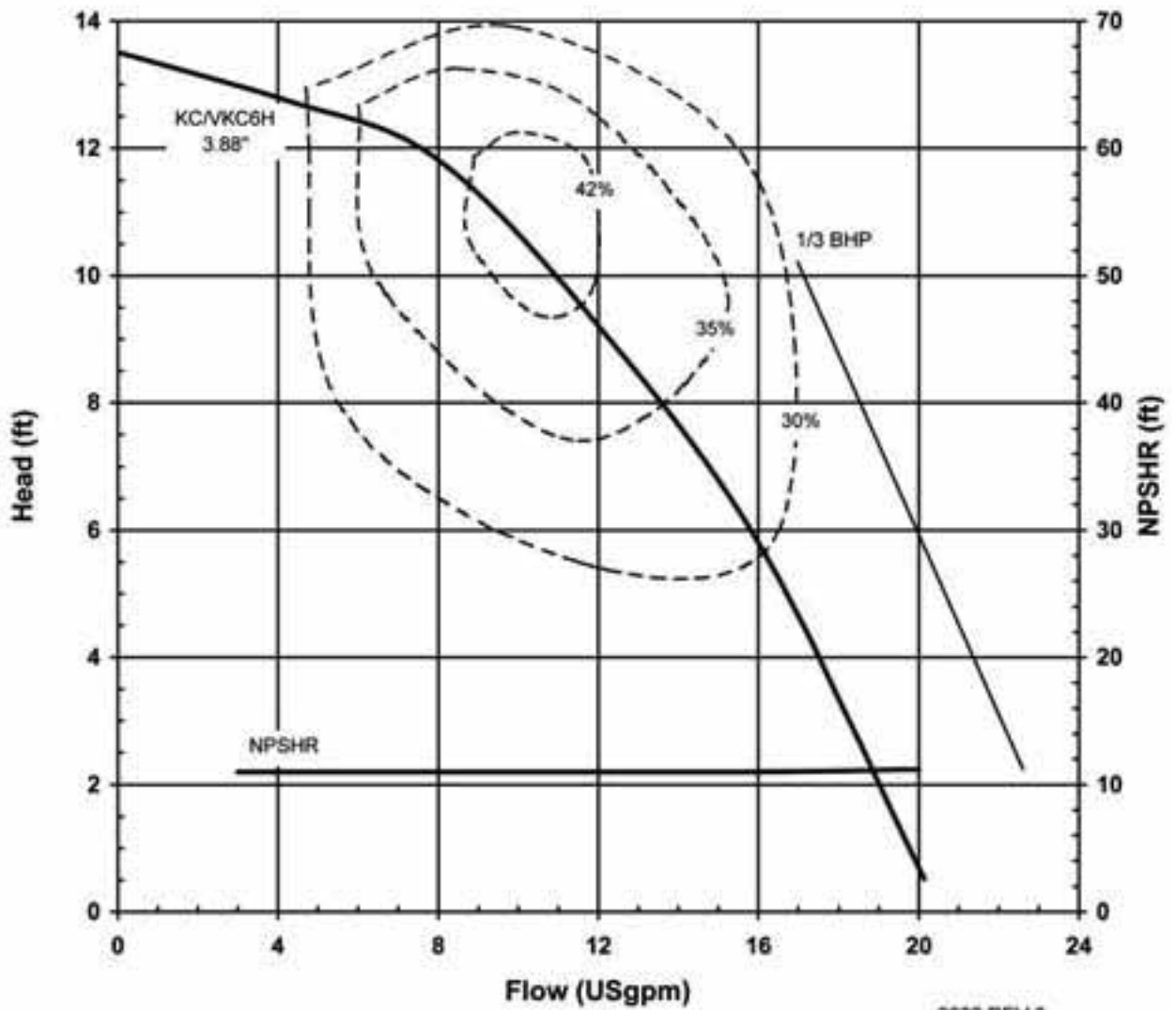

2032 REV 0
01/01/2009



KC/VKC SERIES
MODELS KC/VKC 6H
PERFORMANCE CURVE

**MODEL KC6H
VKC6H**

2900 rpm, 50 Hz
Suction: 1" FNPT
Discharge: 3/4" MNPT

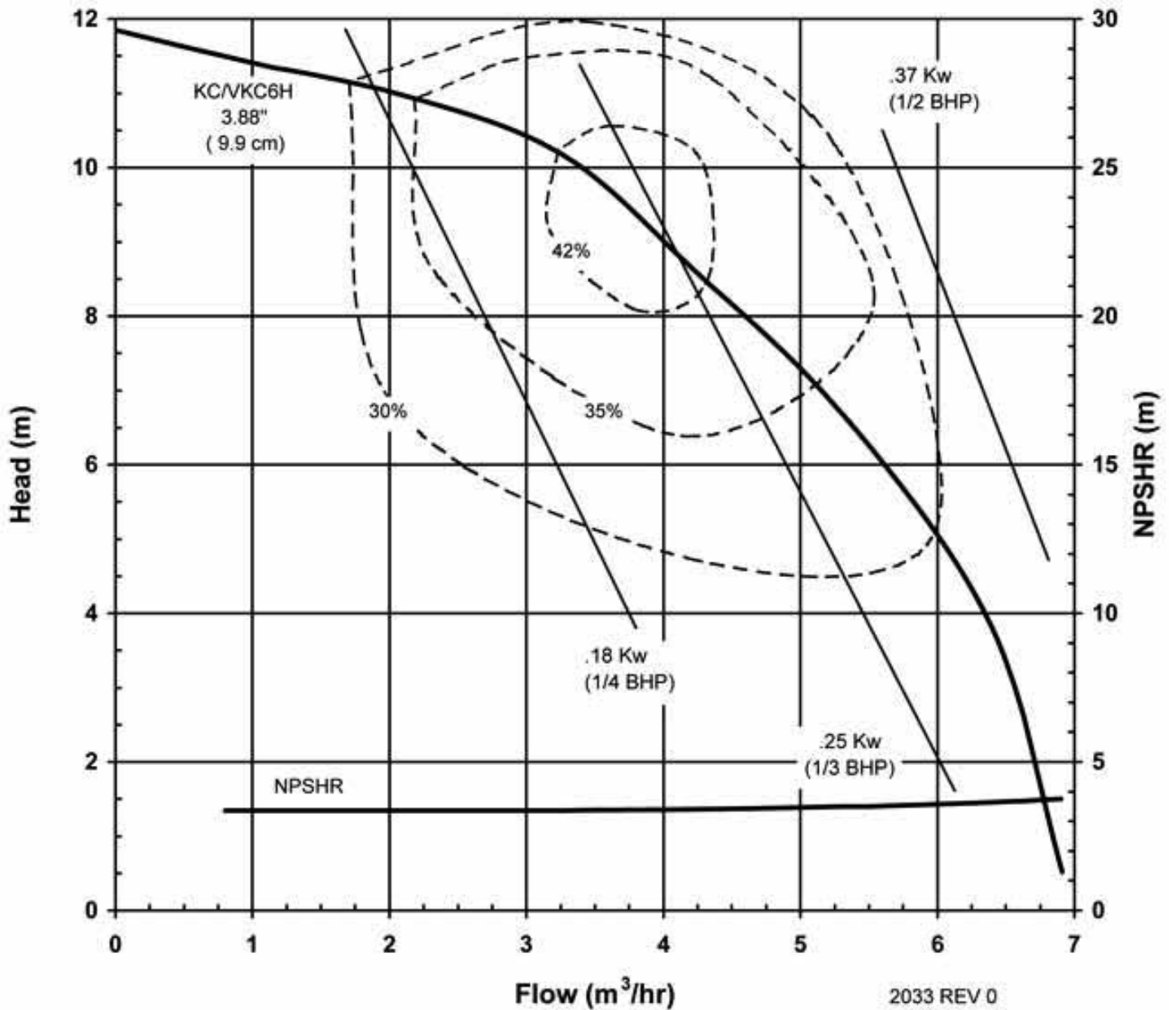

2033 REV 0
01/01/2009



KC/VKC SERIES
MODELS KC/VKC 6H
PERFORMANCE CURVE

**MODEL KC6H
VKC6H**
1450 rpm, 50 Hz
Suction: 1" FNPT
Discharge: 3/4" MNPT

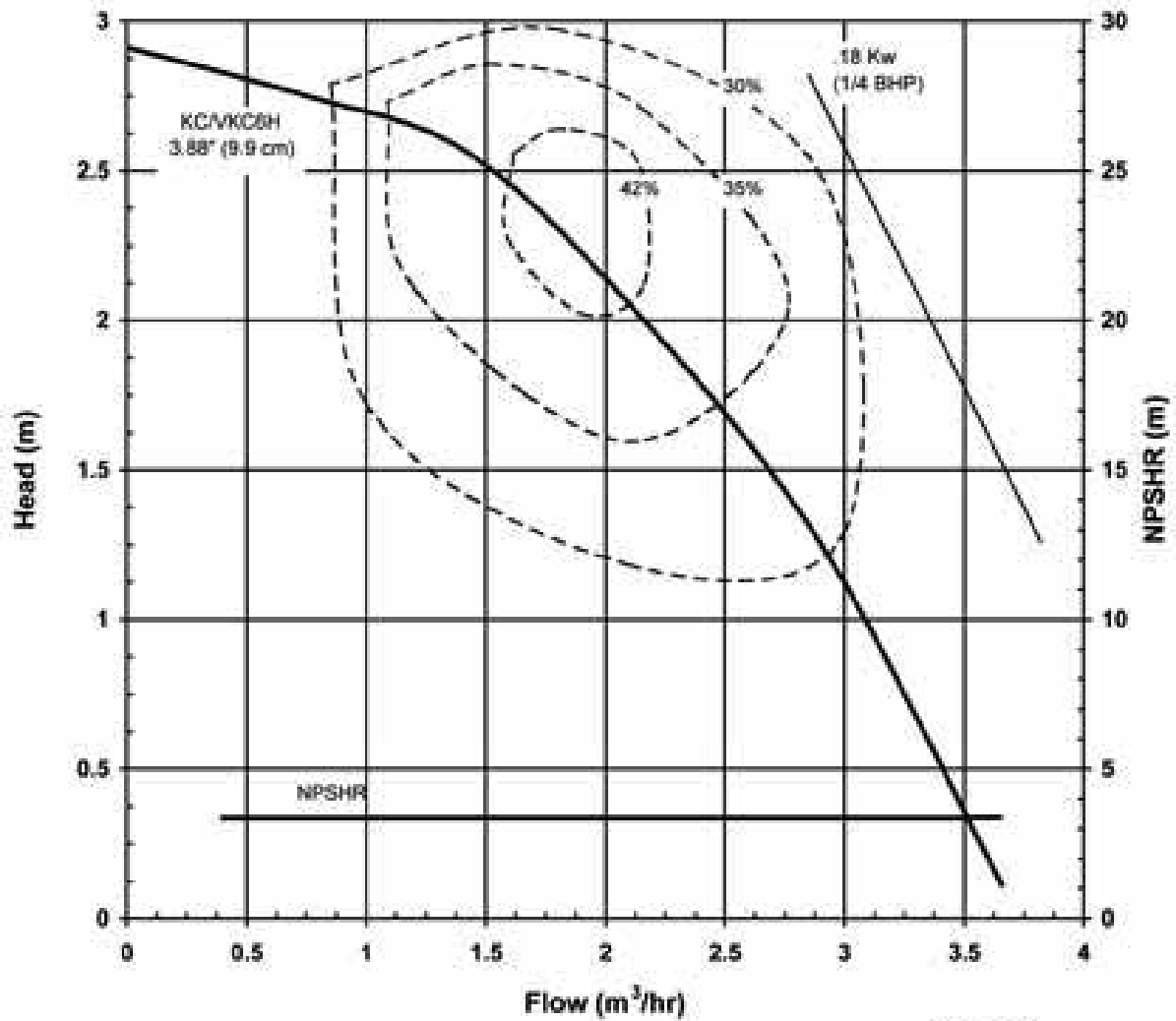

2034 REV 0
01/01/2009



KC/VKC SERIES
MODELS KC/VKC 7
PERFORMANCE CURVE

**MODEL KC7
VKC7**

**3450 rpm, 60 Hz
Suction: 1 1/2" FNPT
Discharge: 1" MNPT**

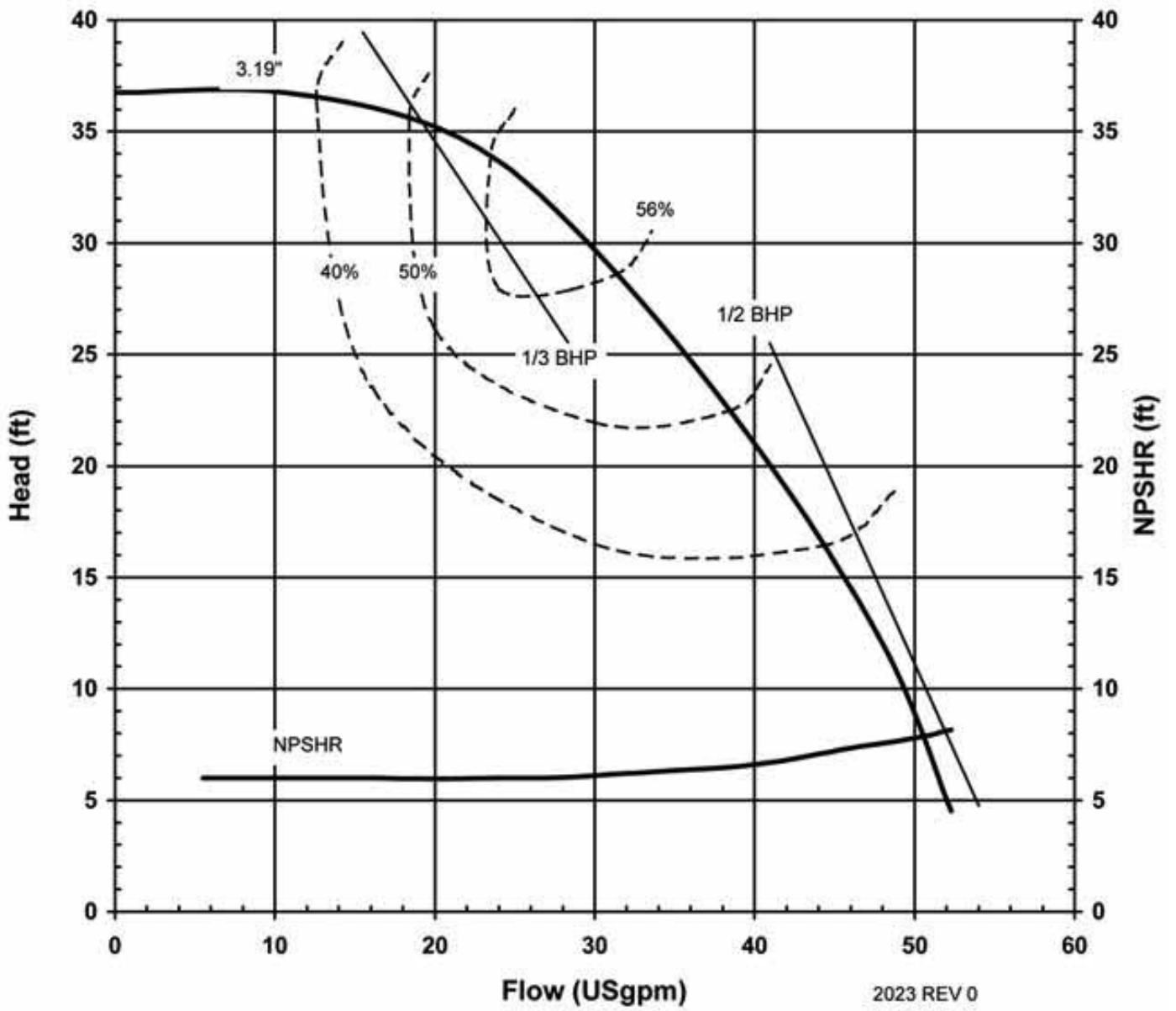

2023 REV 0
01/01/2009



KC/VKC SERIES
MODELS KC/VKC 7
PERFORMANCE CURVE

**MODEL KC7
VKC7**
1725 rpm, 60 Hz
Suction: 1 1/2" FNPT
Discharge: 1" MNPT

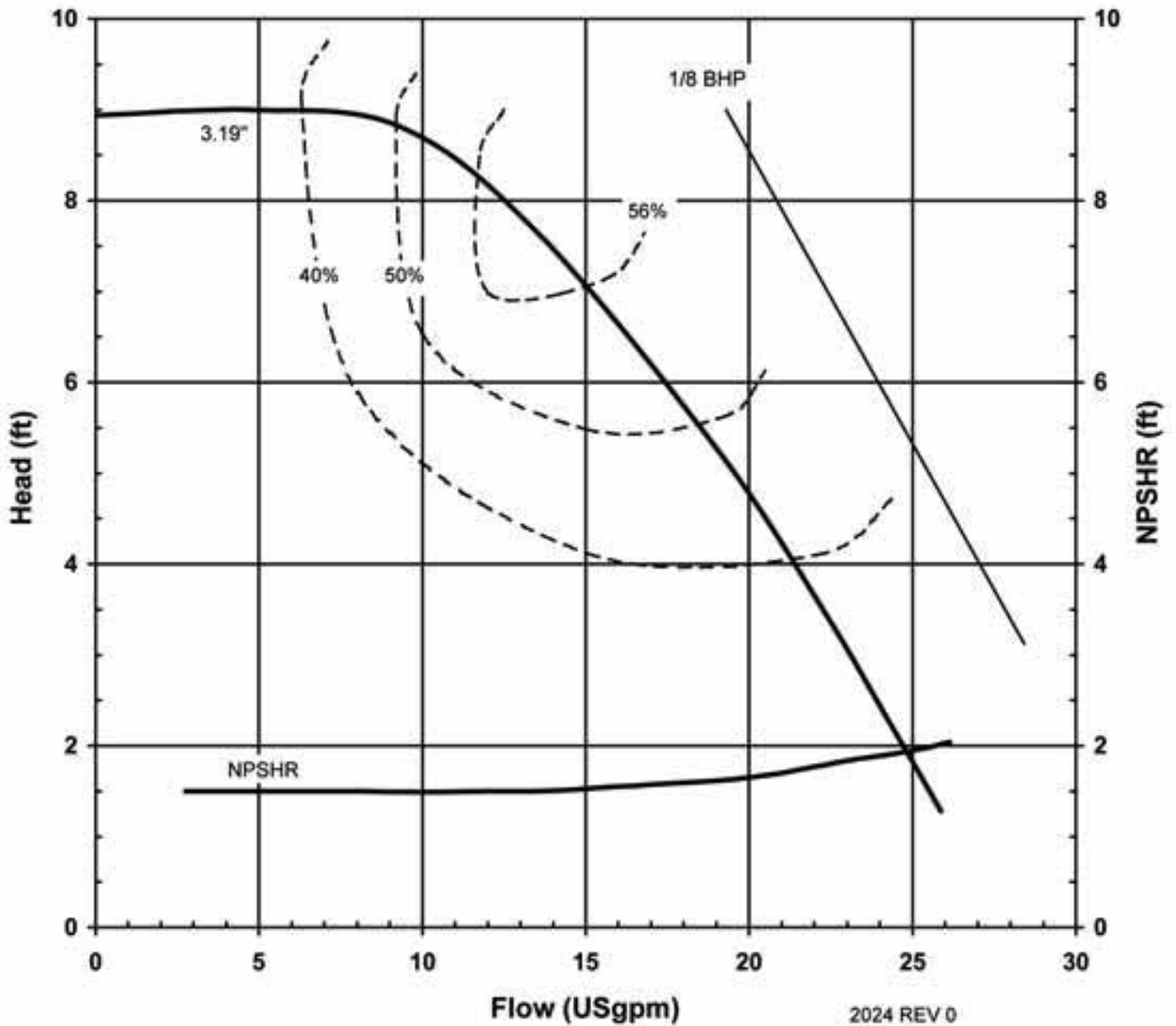

2024 REV 0
01/01/2009



KC/VKC SERIES
MODELS KC/VKC 7
PERFORMANCE CURVE

**MODEL KC7
VKC7**
2900 rpm, 50 Hz
Suction: 1 1/2" FNPT
Discharge: 1" MNPT

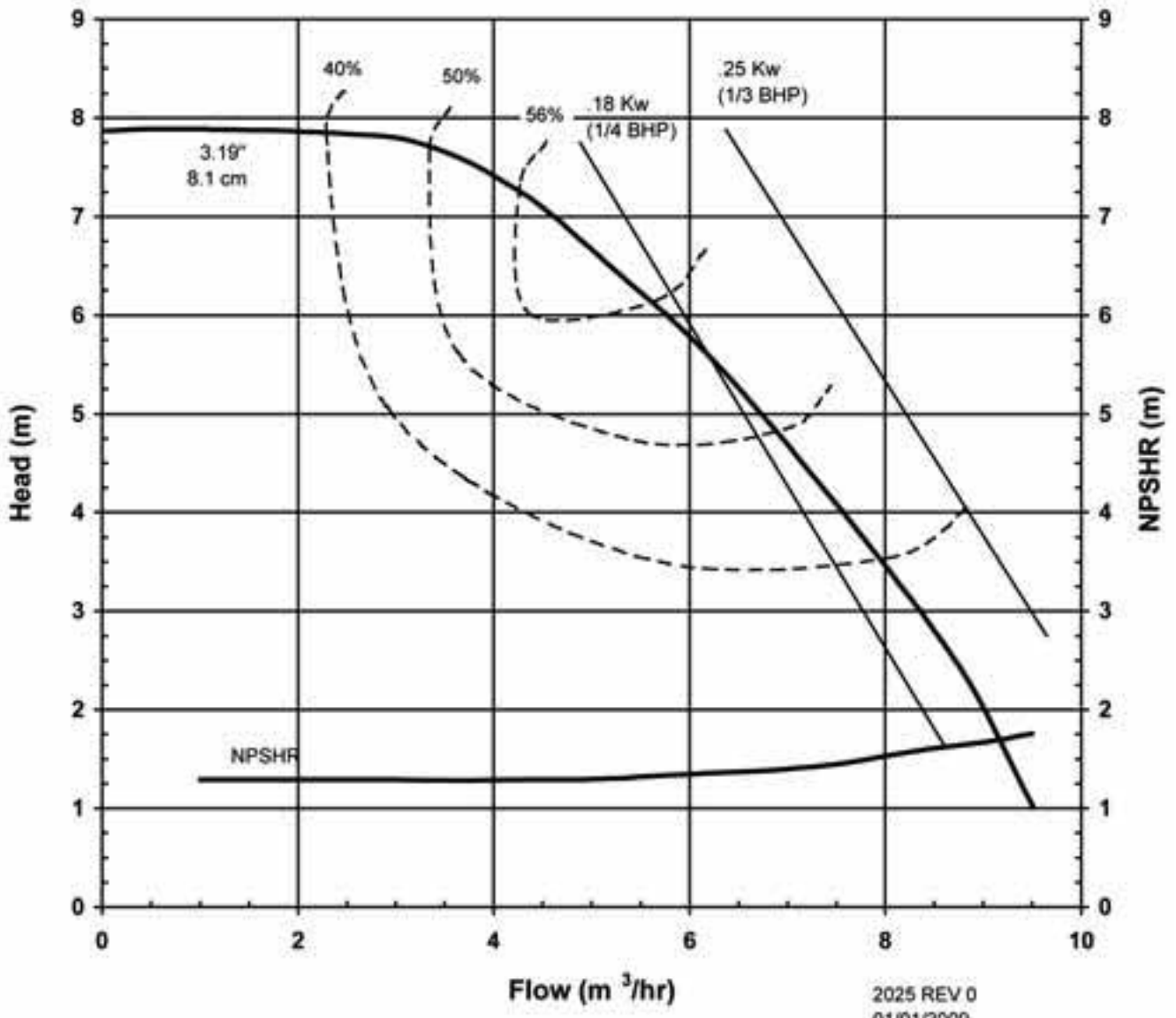

2025 REV 0
01/01/2009



KC/VKC SERIES
MODELS KC/VKC 7
PERFORMANCE CURVE

**MODEL KC7
VKC7**
1450 rpm, 50 Hz
Suction: 1 1/2" FNPT
Discharge: 1" MNPT

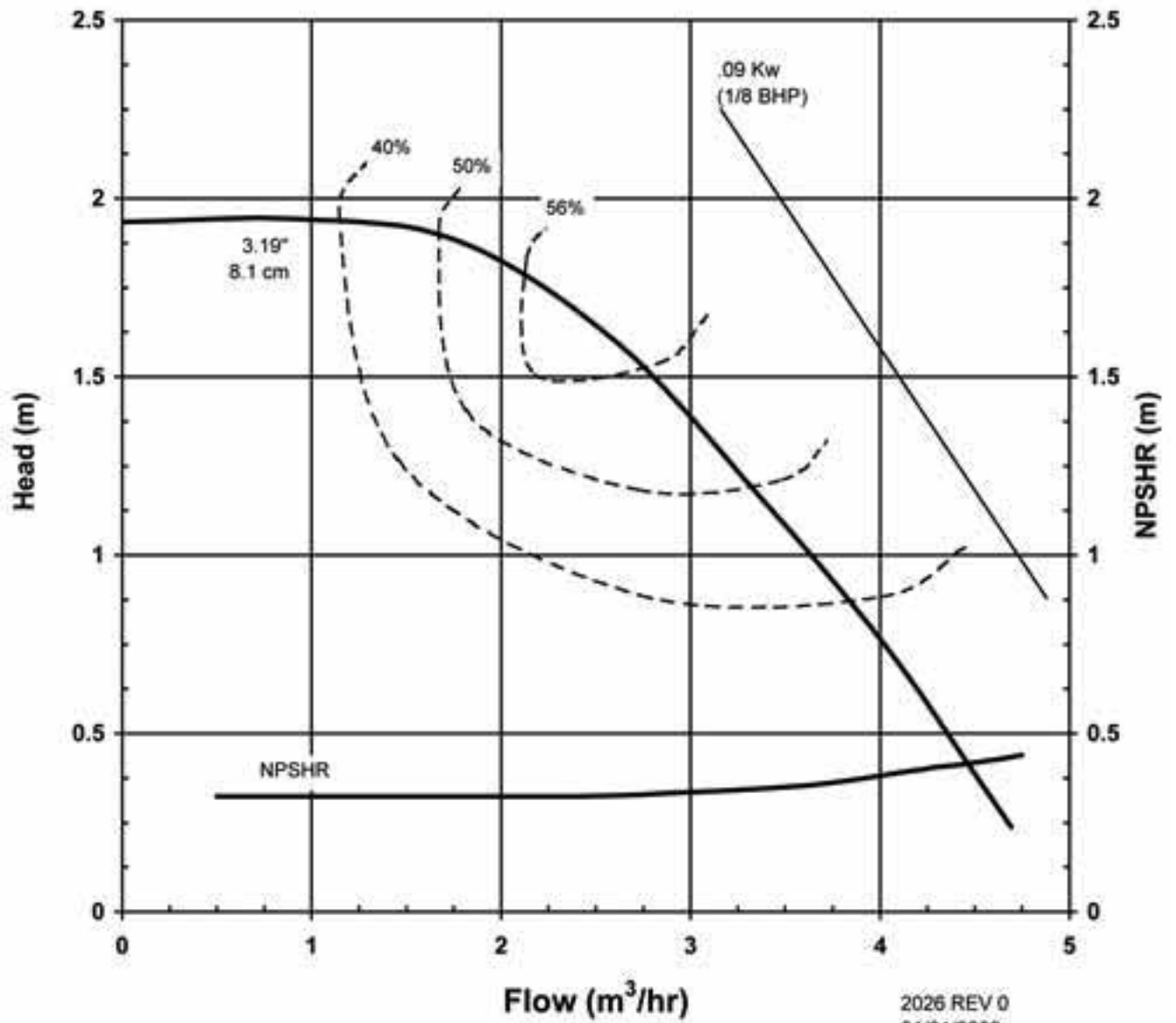



KC/VKC SERIES
MODEL KC/VKC 8 & 10
PERFORMANCE CURVE

MODEL KC8/10
VKC8/10
3450 rpm, 60 Hz
Suction: 1 1/2" FNPT
Discharge: 1" MNPT

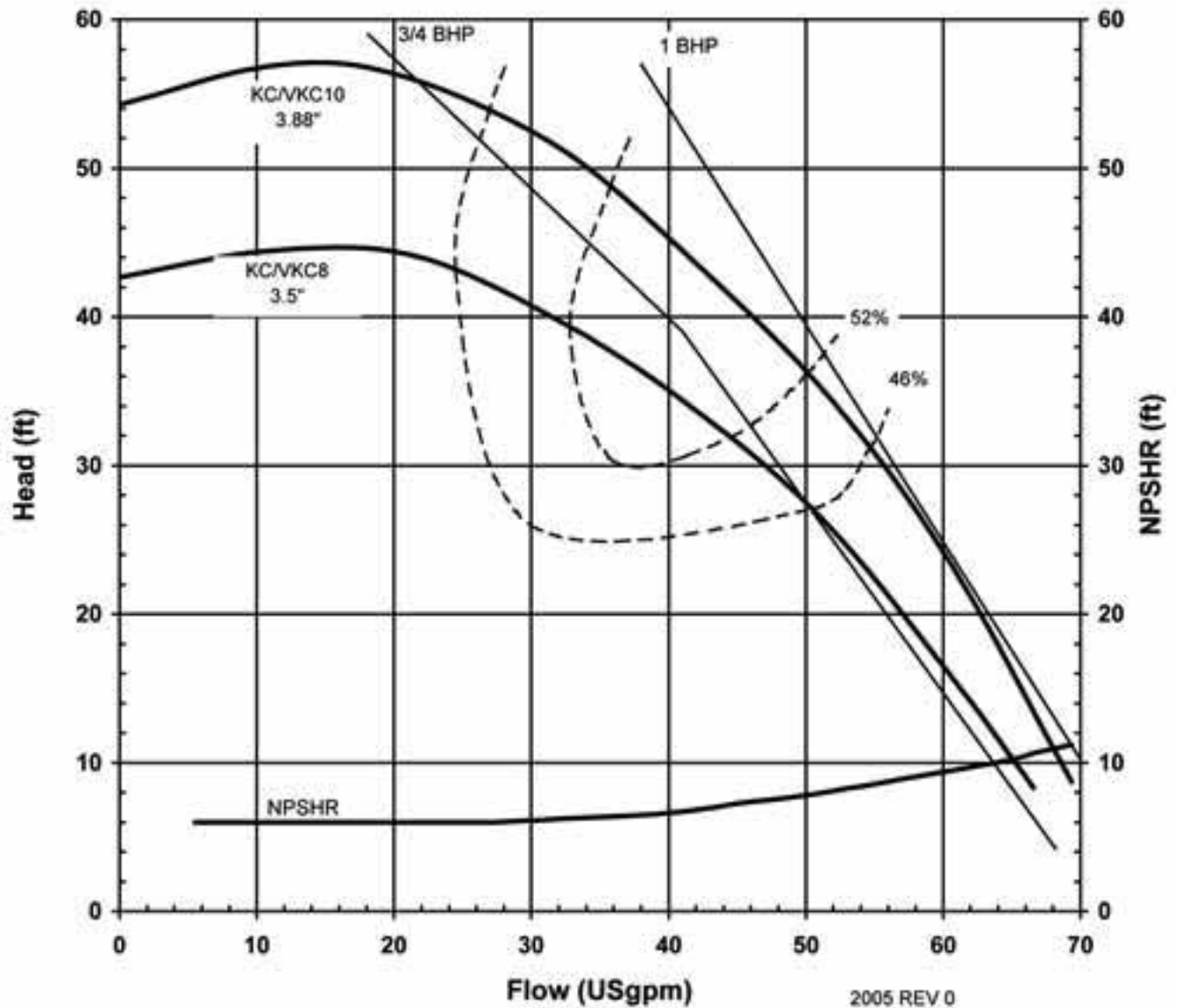

2005 REV 0
101/01/2009



KC/VKC SERIES
MODELS KC/VKC 8 & 10
PERFORMANCE CURVE

**MODEL KC8/10
VKC8/10**

1725 rpm, 60 Hz
Suction: 1 1/2" FNPT
Discharge: 1" MNPT

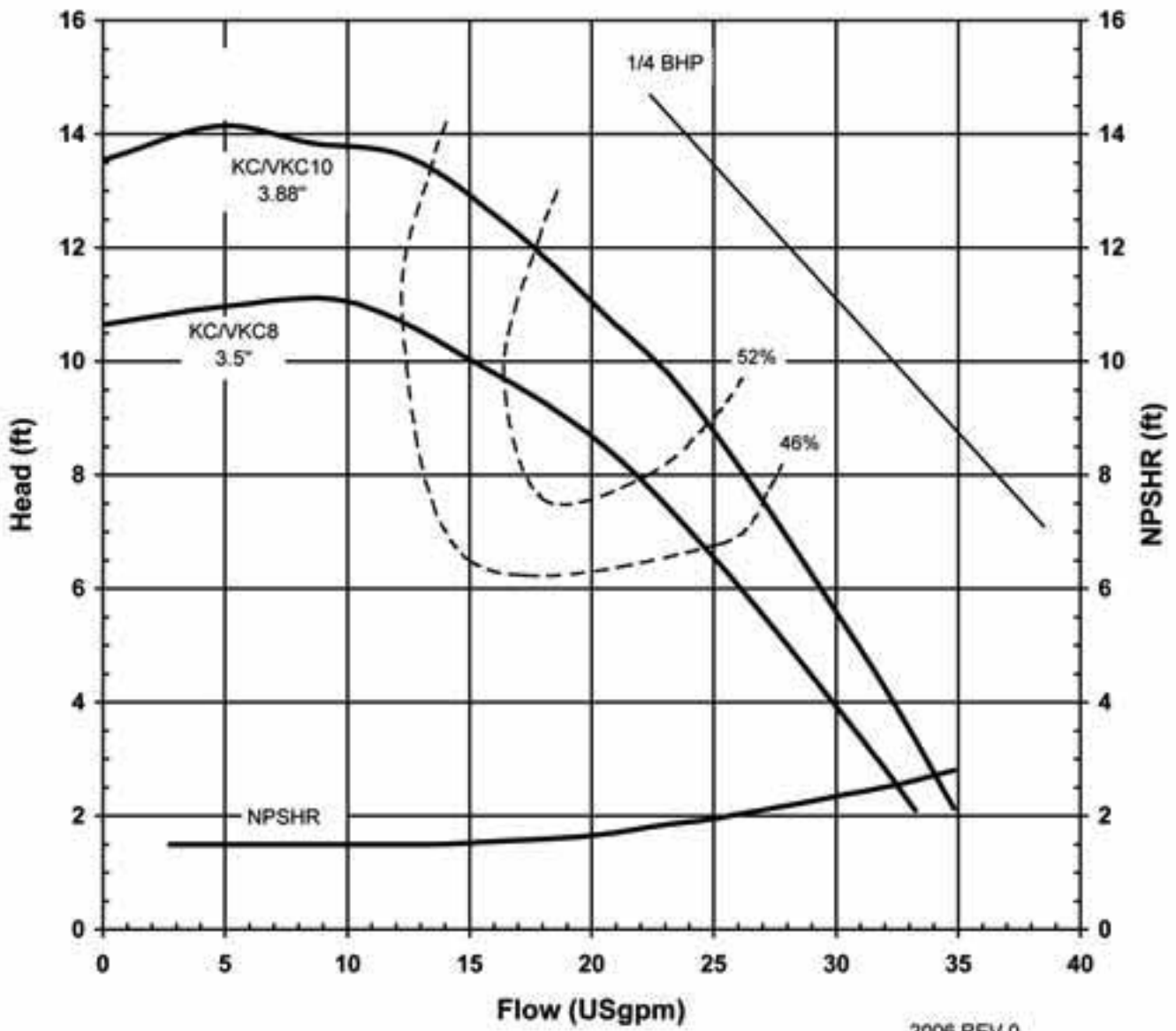

2006 REV 0
101-01-2009



KC/VKC SERIES
MODELS KC/VKC 8 & 10
PERFORMANCE CURVE

**MODEL KC8/10
VKC8/10**
2900 rpm, 50 Hz
Suction: 1 1/2" FNPT
Discharge: 1" MNPT

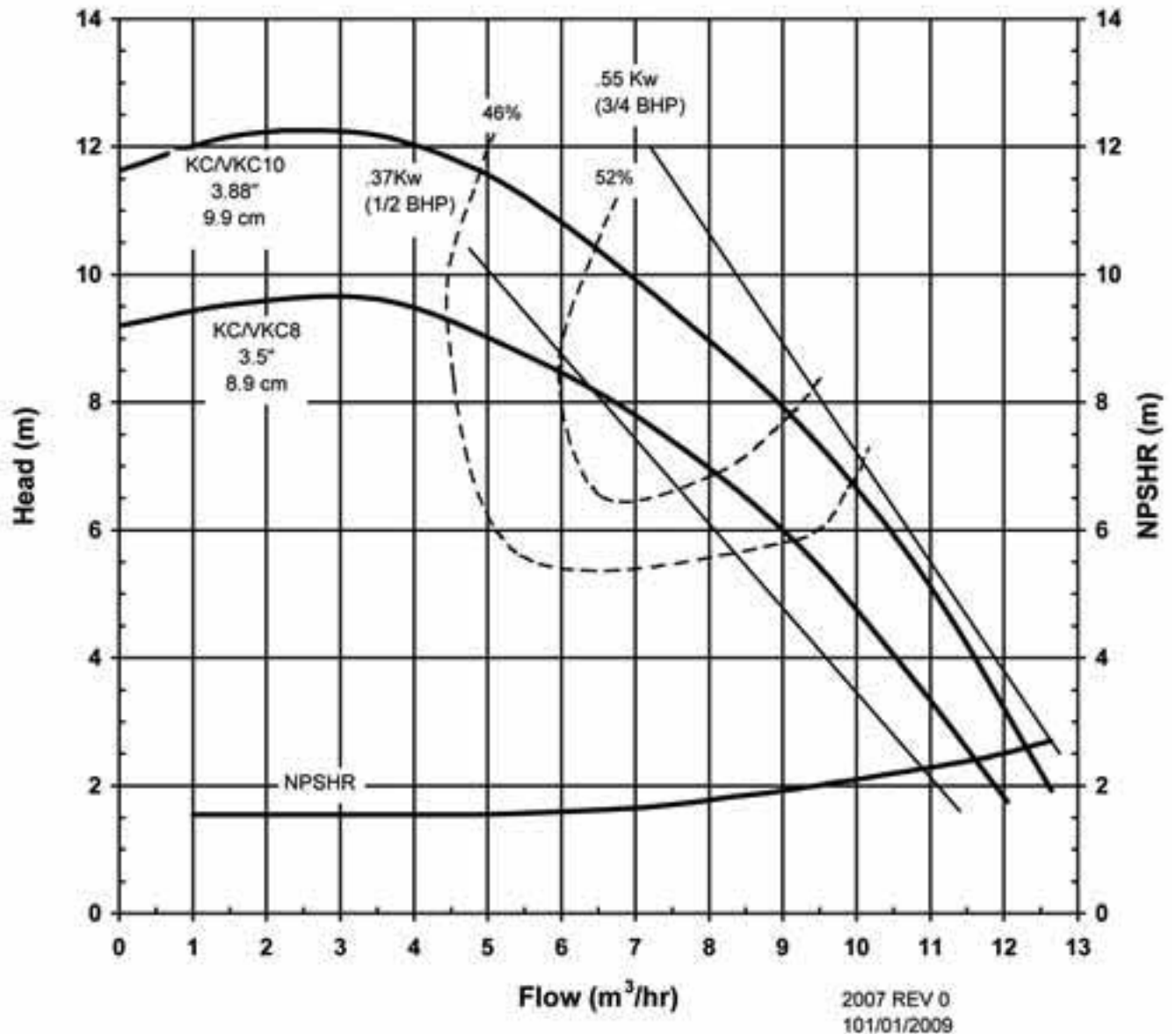

2007 REV 0
101/01/2009



KC/VKC SERIES
MODELS KC/VKC 8 & 10
PERFORMANCE CURVE

**MODEL KC8/10
VKC8/10**
1450 rpm, 50 Hz
Suction: 1 1/2" FNPT
Discharge: 1" MNPT

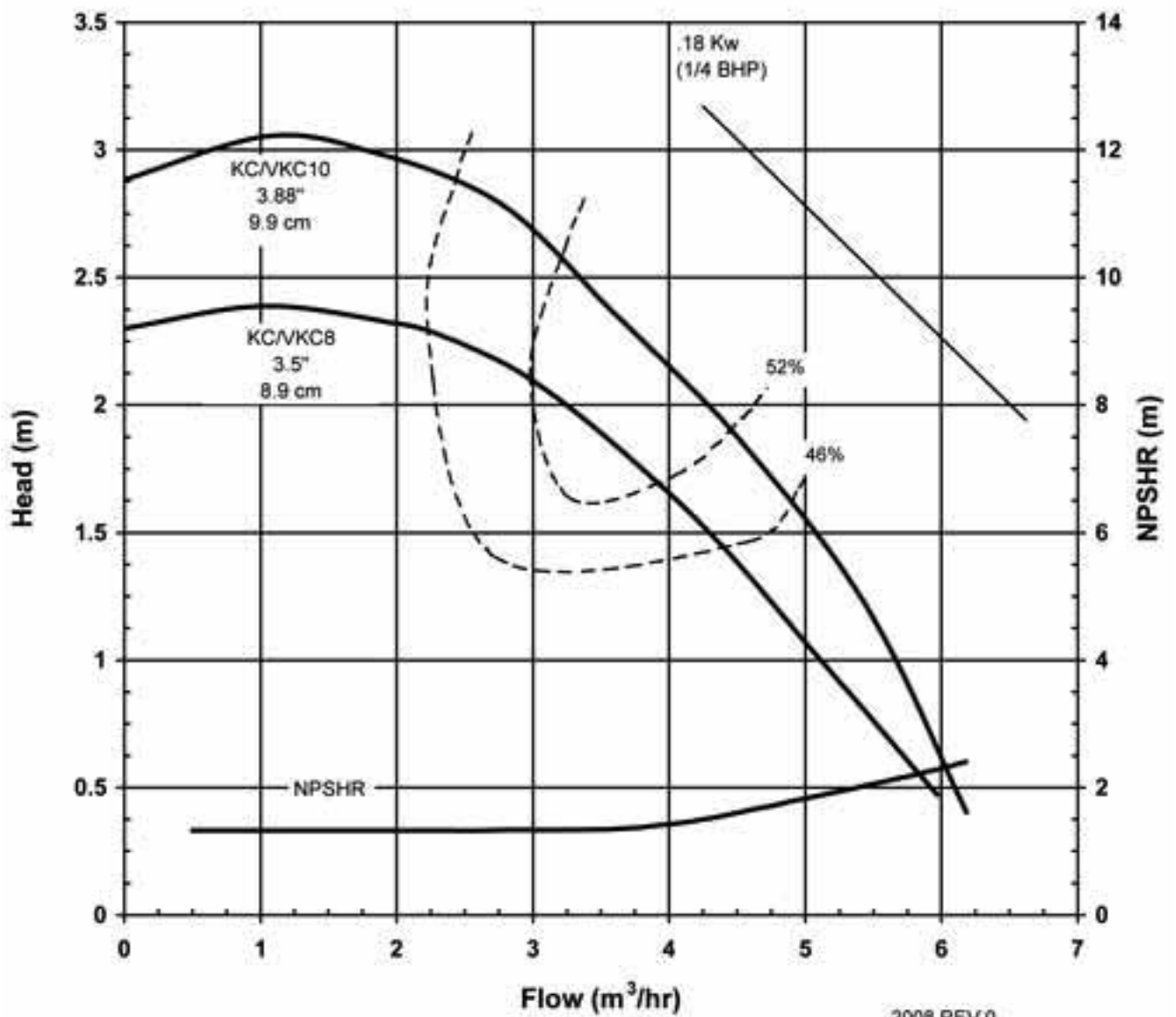

2008 REV 0
01/01/2009



KC SERIES
MODEL KC11
PERFORMANCE CURVE

MODEL KC11
3450 rpm, 60 Hz
Suction: 1 1/2" FNPT
Discharge: 1 1/4" MNPT

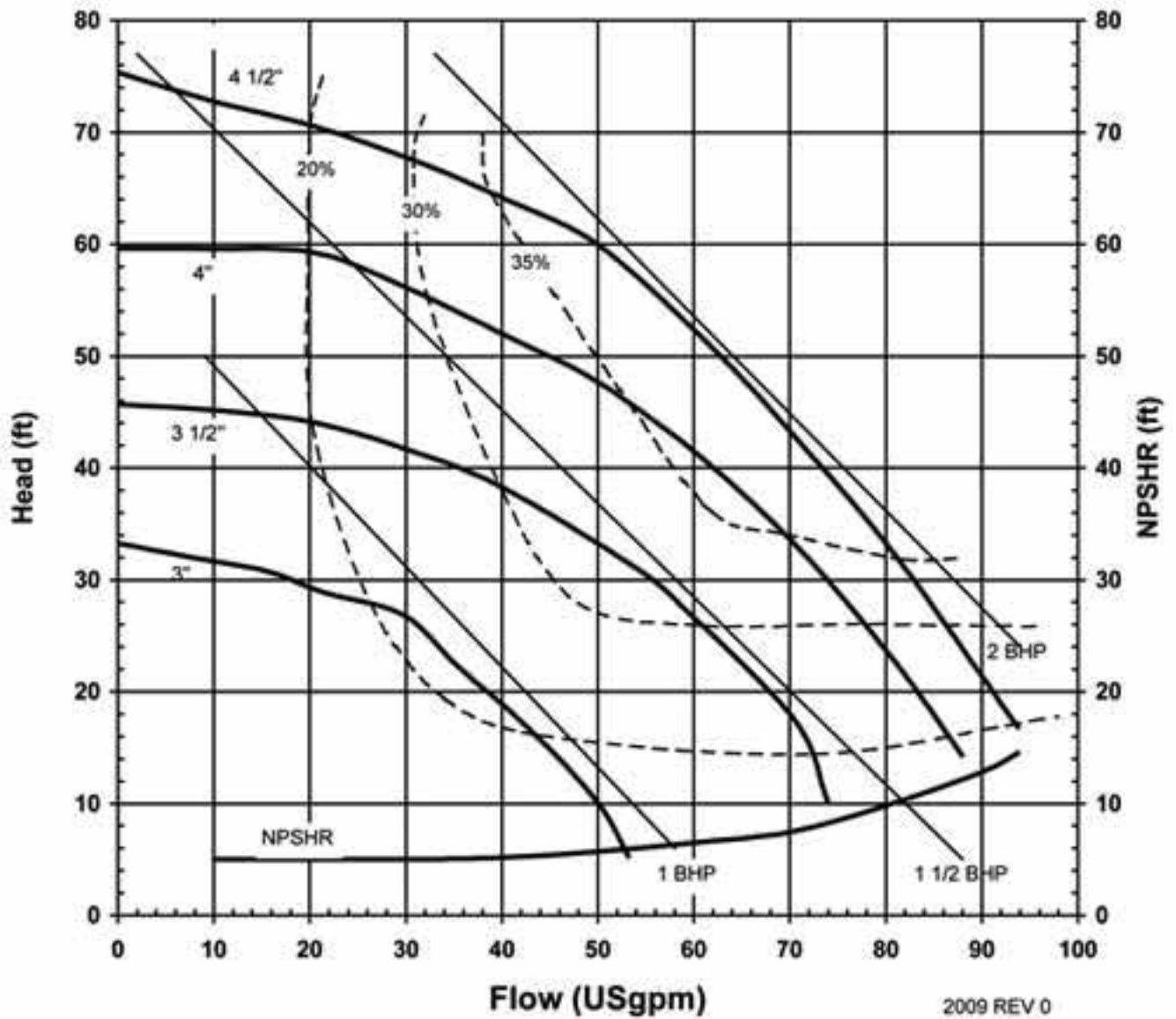

2009 REV 0
01/01/2009



KC SERIES
MODEL KC11
PERFORMANCE CURVE

MODEL KC11

1725 rpm, 60 Hz

Suction: 1 1/2" FNPT

Discharge: 1 1/4" MNPT

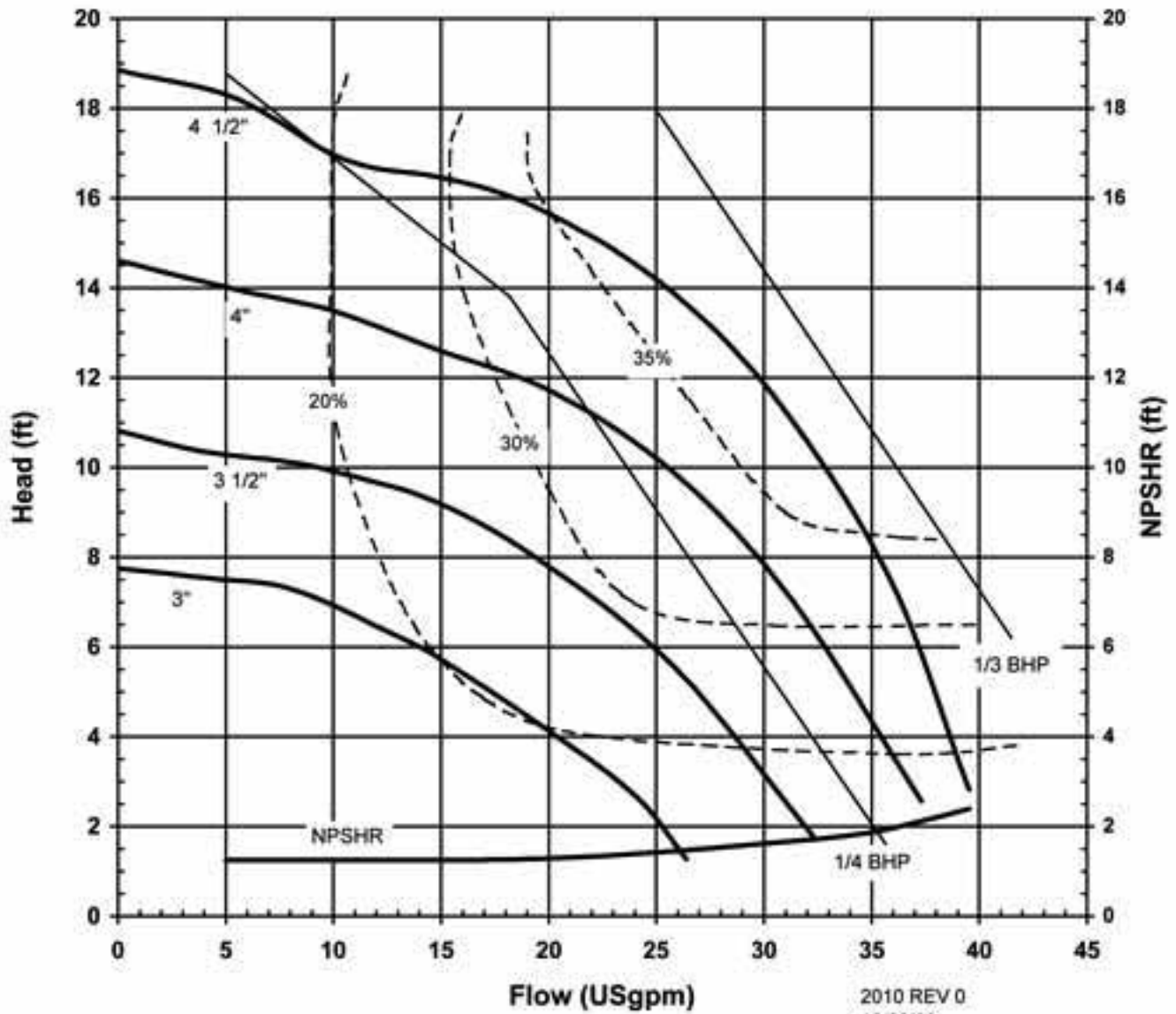



KC SERIES
MODEL KC11
PERFORMANCE CURVE

MODEL KC11
2900 rpm, 50 Hz
Suction: 1 1/2" FNPT
Discharge: 1 1/4" MNPT

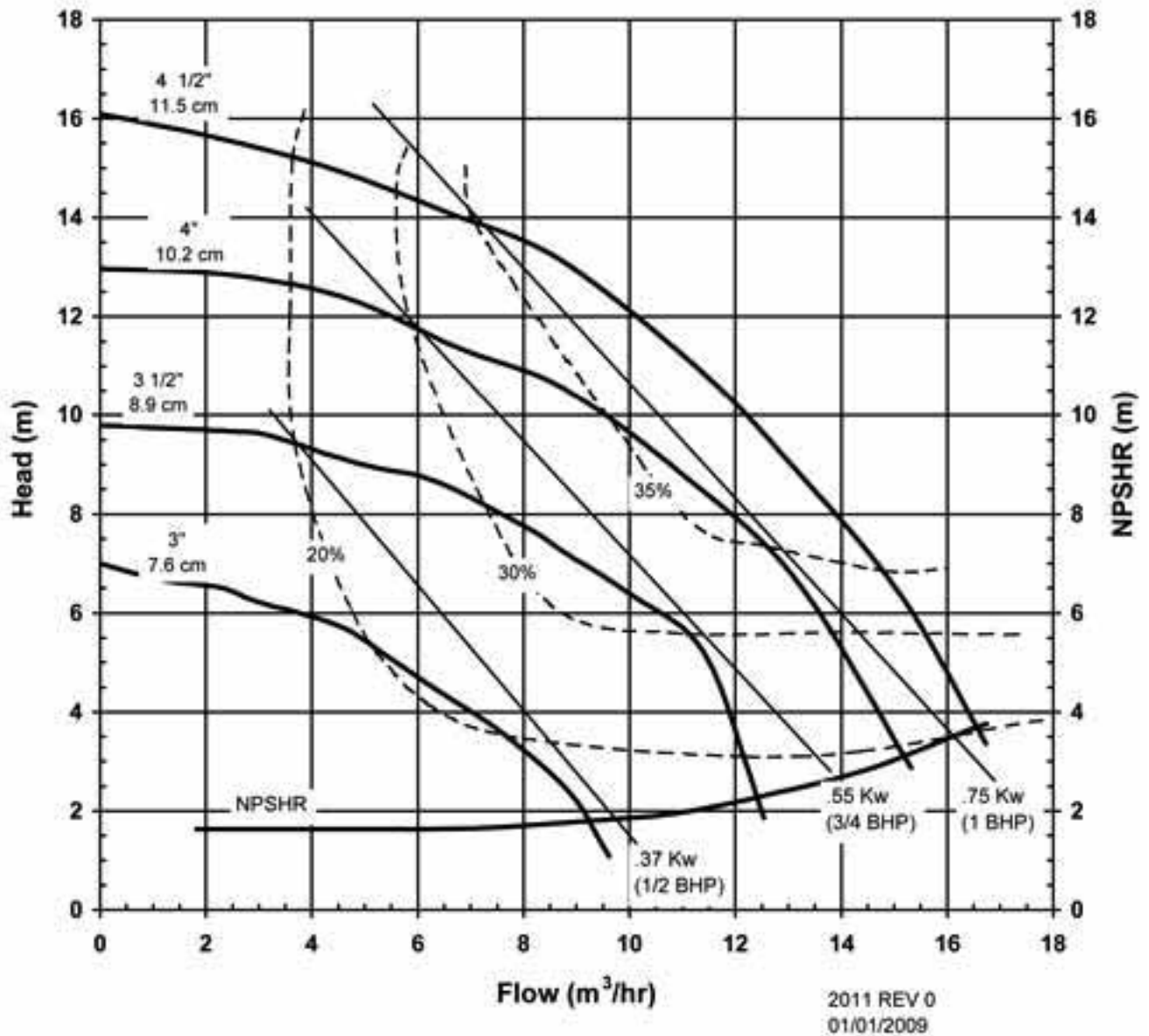



KC SERIES
MODEL KC11
PERFORMANCE CURVE

MODEL KC11
1450 rpm, 50 Hz
Suction: 1 1/2" FNPT
Discharge: 1 1/4" MNPT

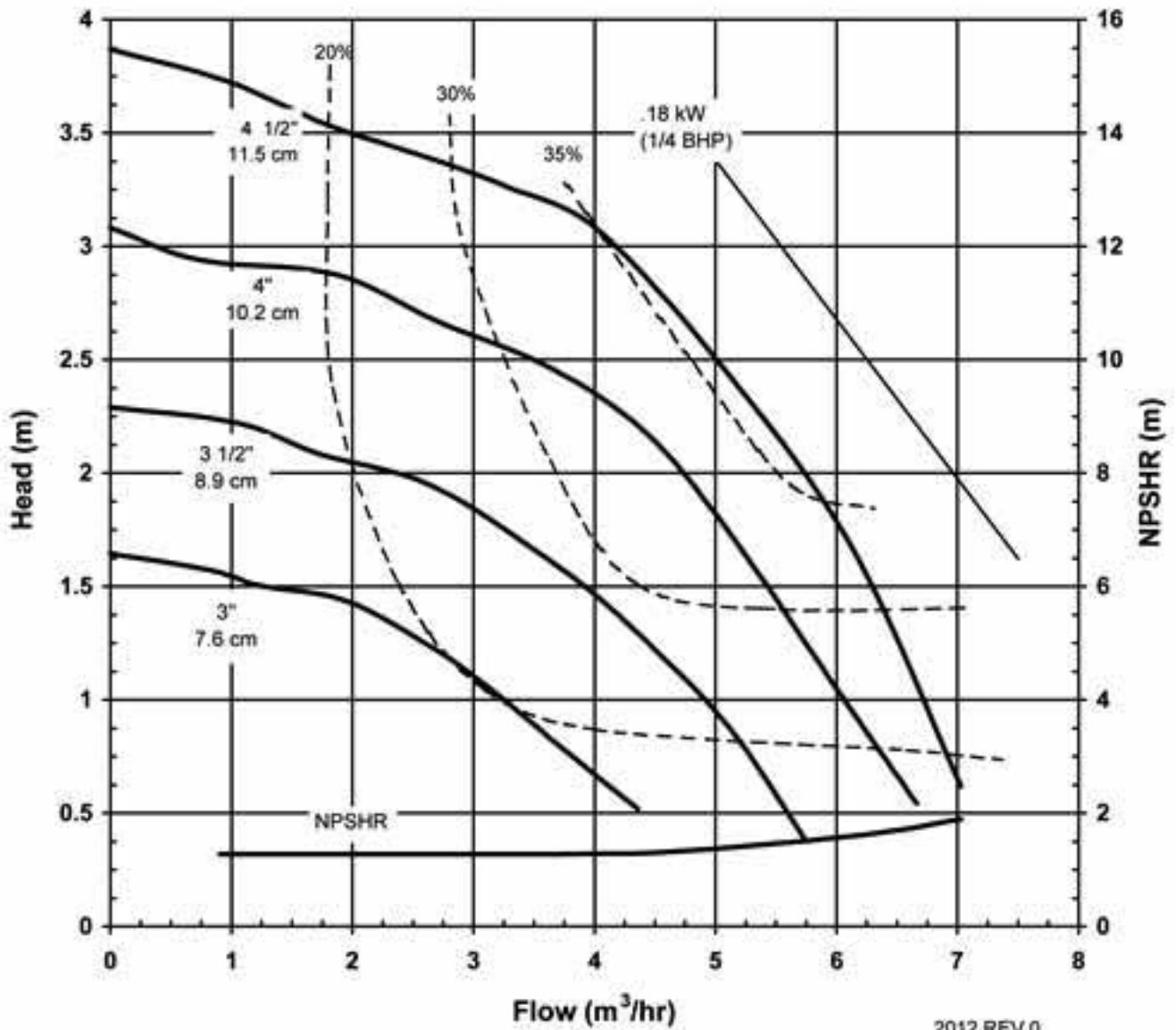

2012 REV 0
01/01/2009



KC SERIES
MODELS KC22 & 32
PERFORMANCE CURVE

MODEL KC22/32

3450 rpm, 60 Hz

Suction: 2" FNPT/3" FLANGE

Discharge: 2" MNPT/2" FLANGE

OPEN IMPELLER

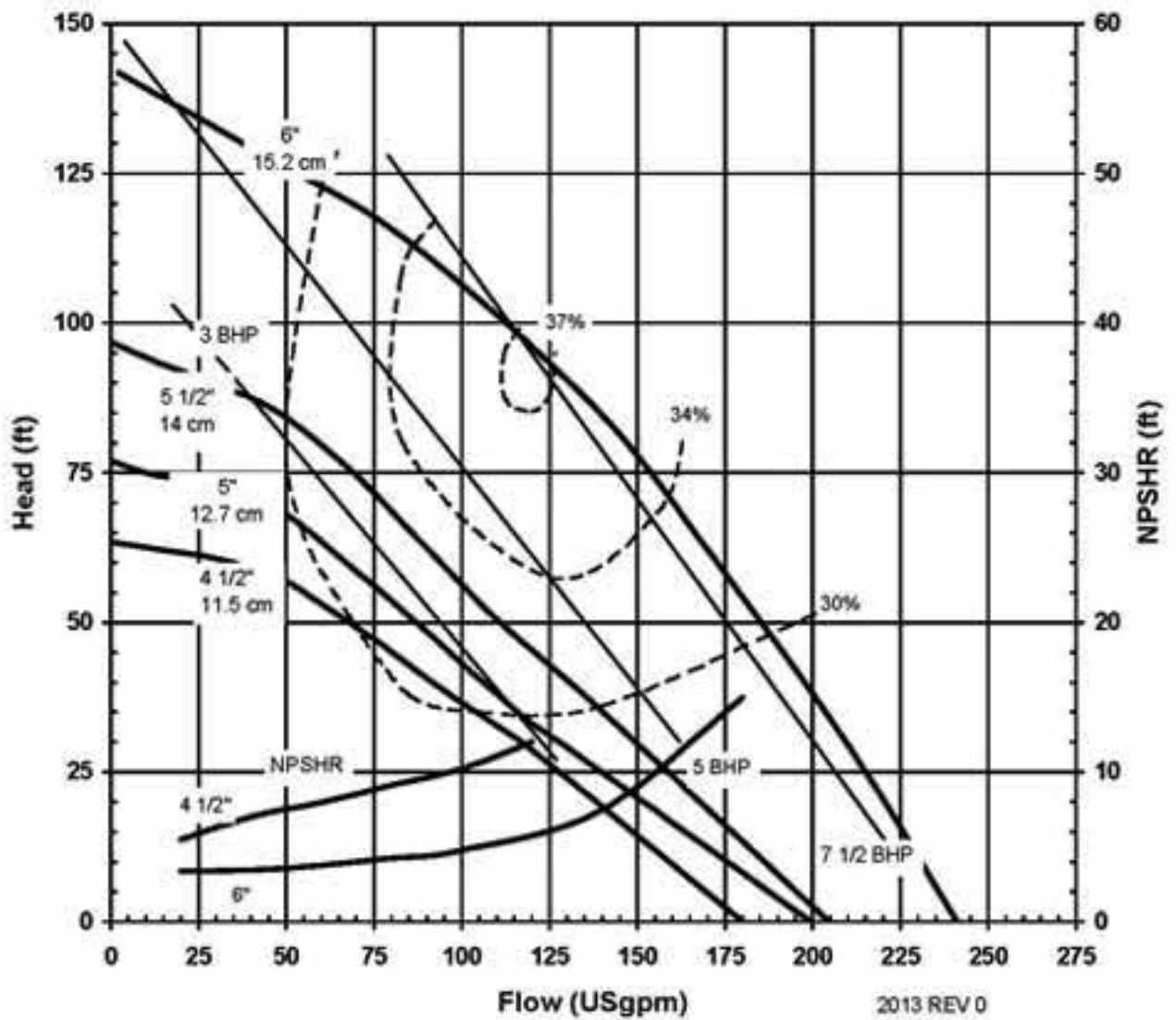

2013 REV 0
1/27/2009



MODEL KC22/32

1725 rpm, 60 Hz
Suction: 2" FNPT/3" FLANGE
Discharge: 2" MNPT/2" FLANGE
OPEN IMPELLER

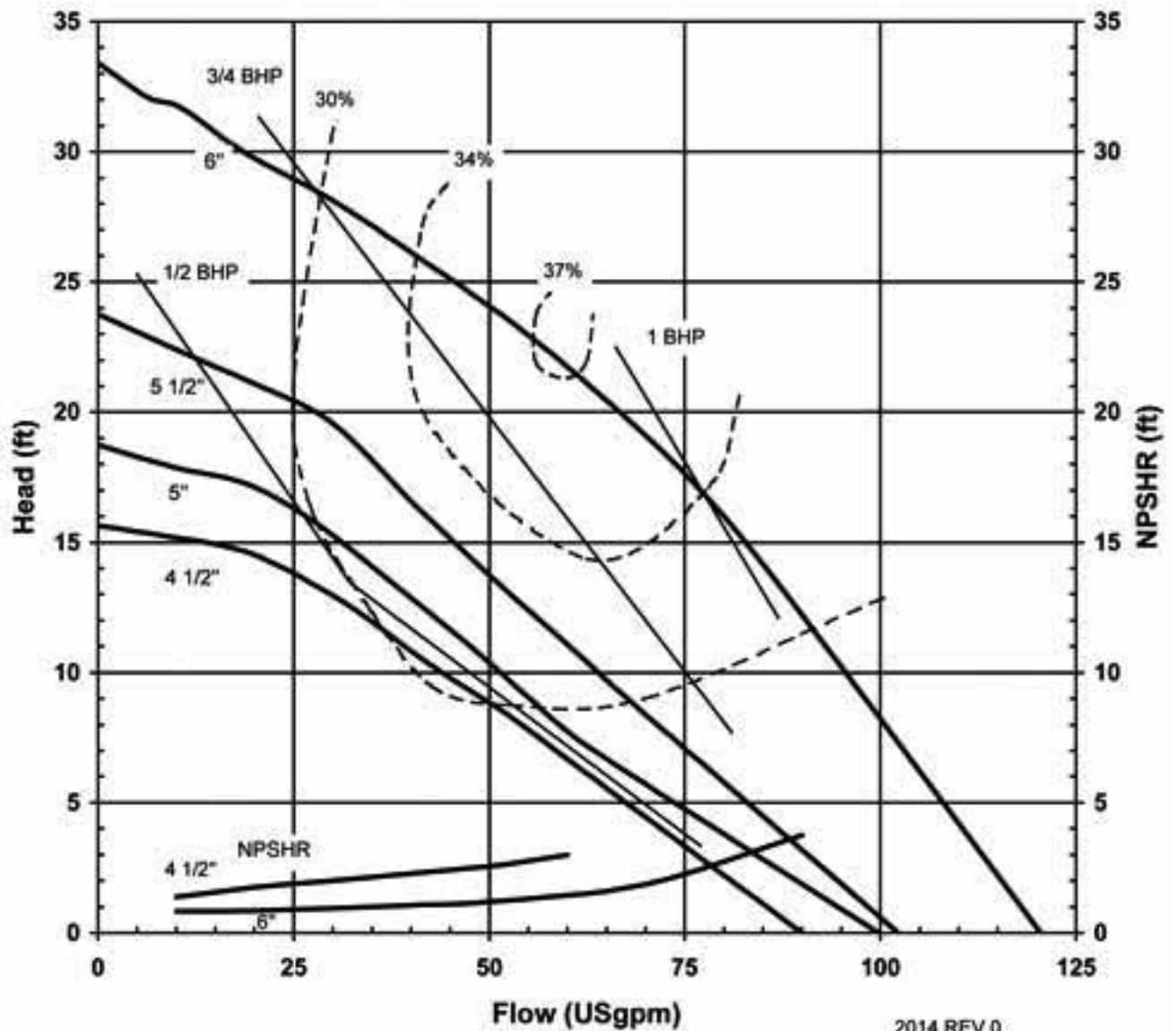

2014 REV 0
12/08/00



KC SERIES
MODELS KC22 & 32
PERFORMANCE CURVE

MODEL KC22/32

2900 rpm, 50 Hz
Suction: 2" FNPT/3" FLANGE
Discharge: 2" MNPT/2" FLANGE
OPEN IMPELLER

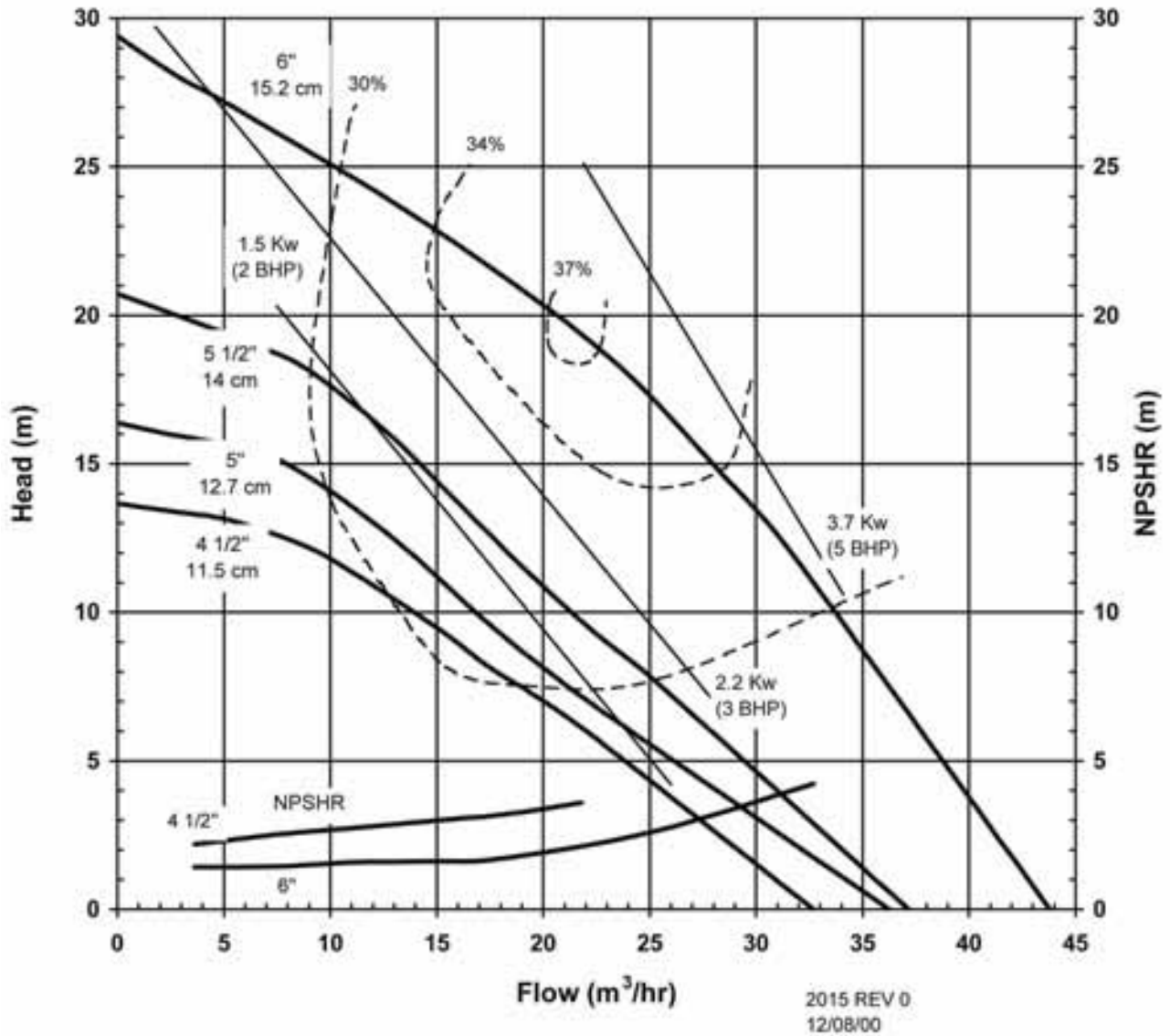



KC SERIES
MODELS KC22 & 32
PERFORMANCE CURVE

MODEL KC22/32

1450 rpm, 50 Hz

Suction: 2" FNPT/3" FLANGE

Discharge: 2" MNPT/2" FLANGE

OPEN IMPELLER

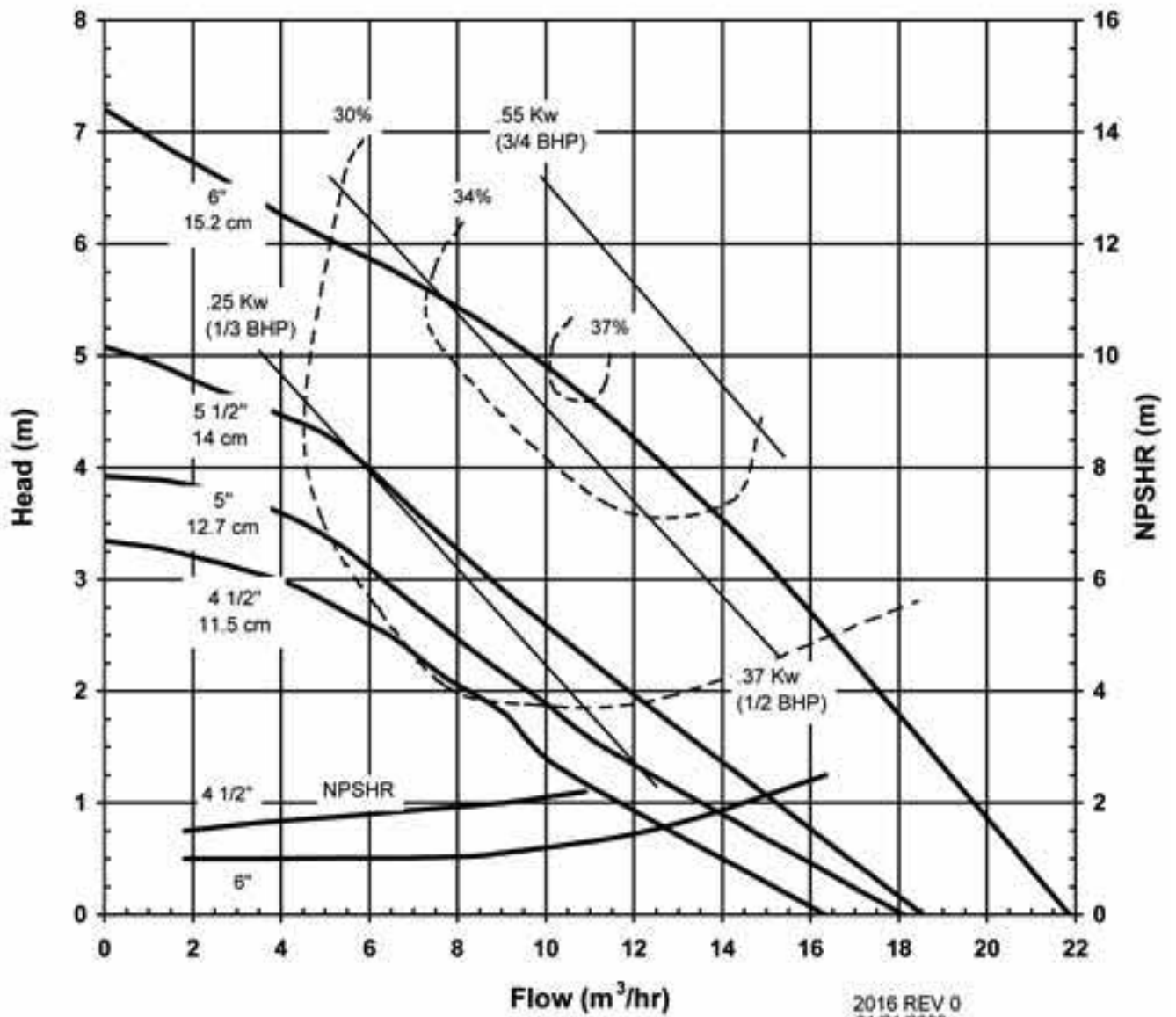



KC SERIES
MODELS KC22 & 32
PERFORMANCE CURVE

MODEL KC22/32

3450 rpm, 60 Hz

Suction: 2" FNPT/3" FLANGE

Discharge: 2" MNPT/2" FLANGE

CLOSED IMPELLER

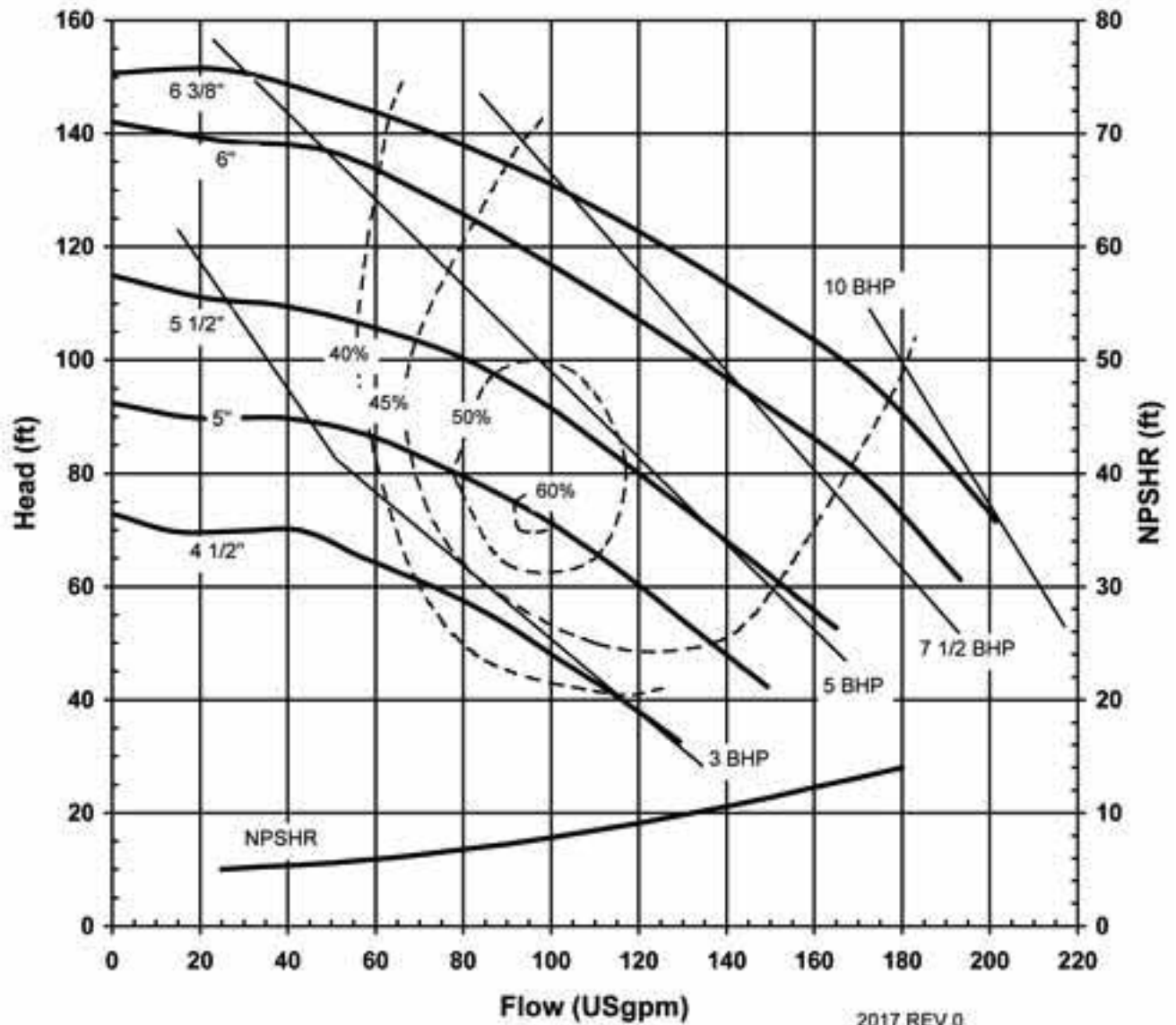

2017 REV 0
1/01/2009



KC SERIES
MODELS KC22 & 32
PERFORMANCE CURVE

MODEL KC22/32

1725 rpm, 60 Hz

Suction: 2" FNPT/3" FLANGE

Discharge: 2" MNPT/2" FLANGE

CLOSED IMPELLER

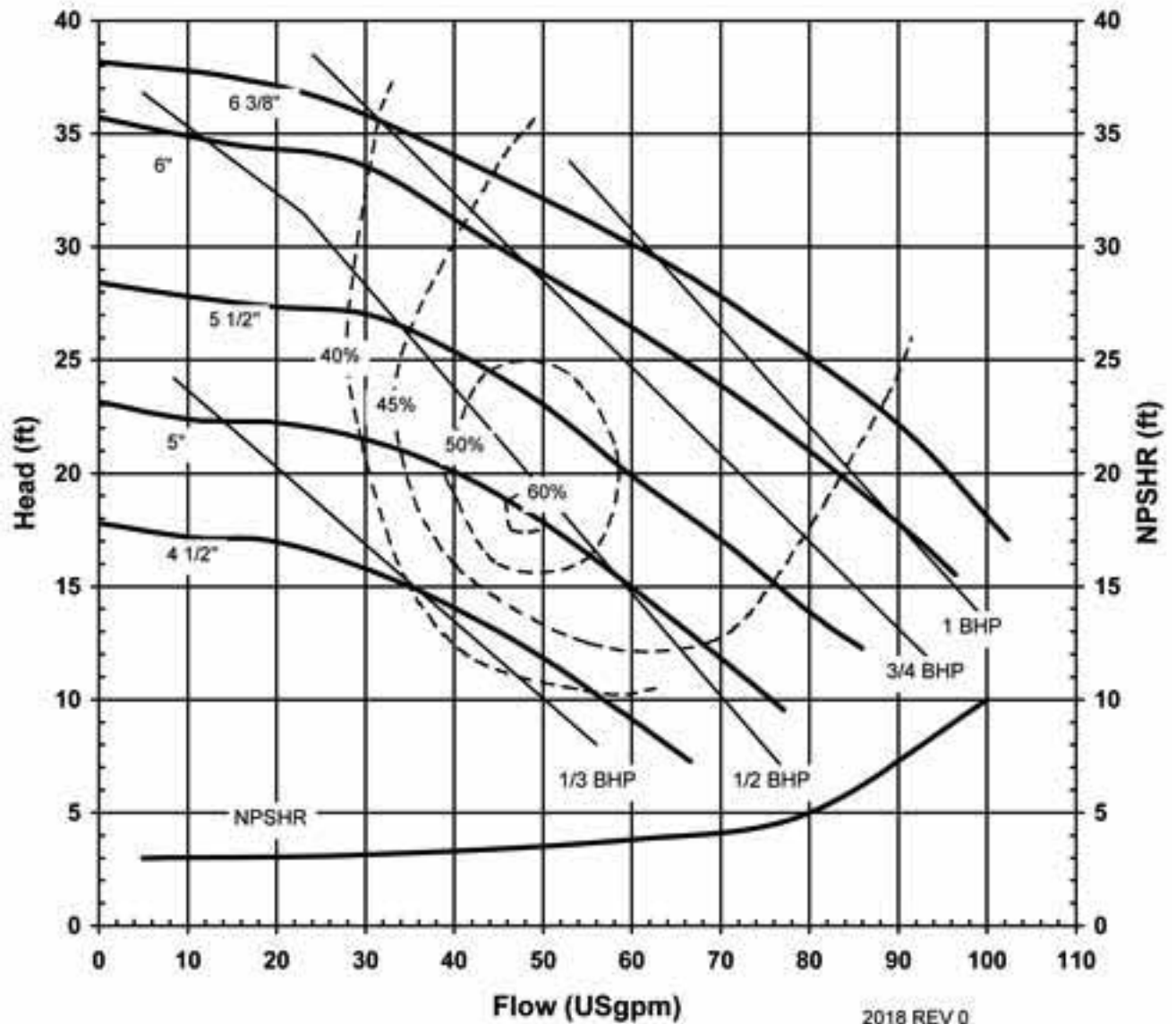

2018 REV 0
12/28/00



MODEL KC22/32

2900 rpm, 50 Hz
Suction: 2" FNPT/3" FLANGE
Discharge: 2" MNPT/2" FLANGE
CLOSED IMPELLER

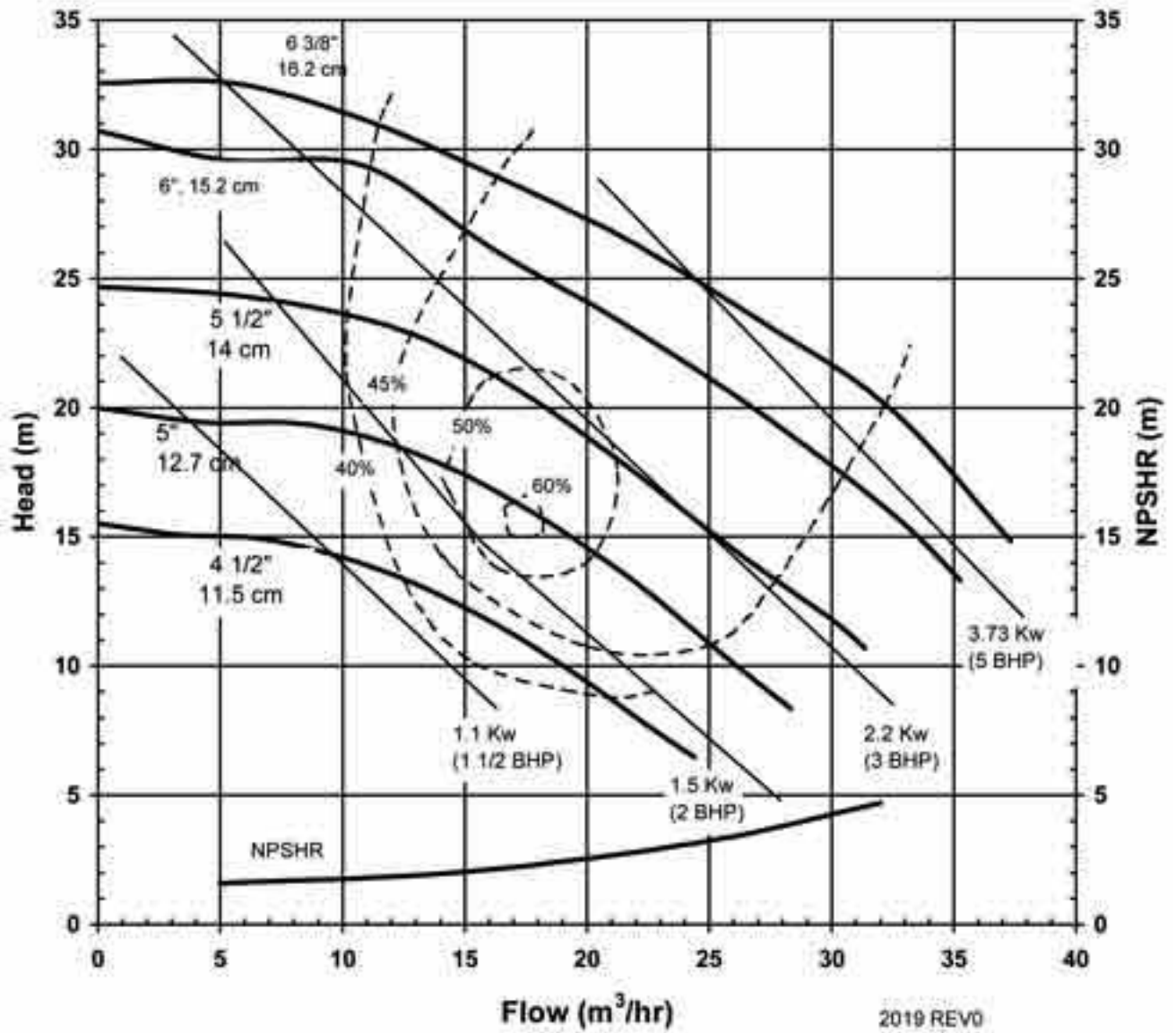

2019 REV0
01/01/2009



KC SERIES
MODELS KC22 & 32
PERFORMANCE CURVE

MODEL KC22/32
1450 rpm, 50 Hz
Suction: 2" FNPT/3" FLANGE
Discharge: 2" MNPT/2" FLANGE
CLOSED IMPELLER

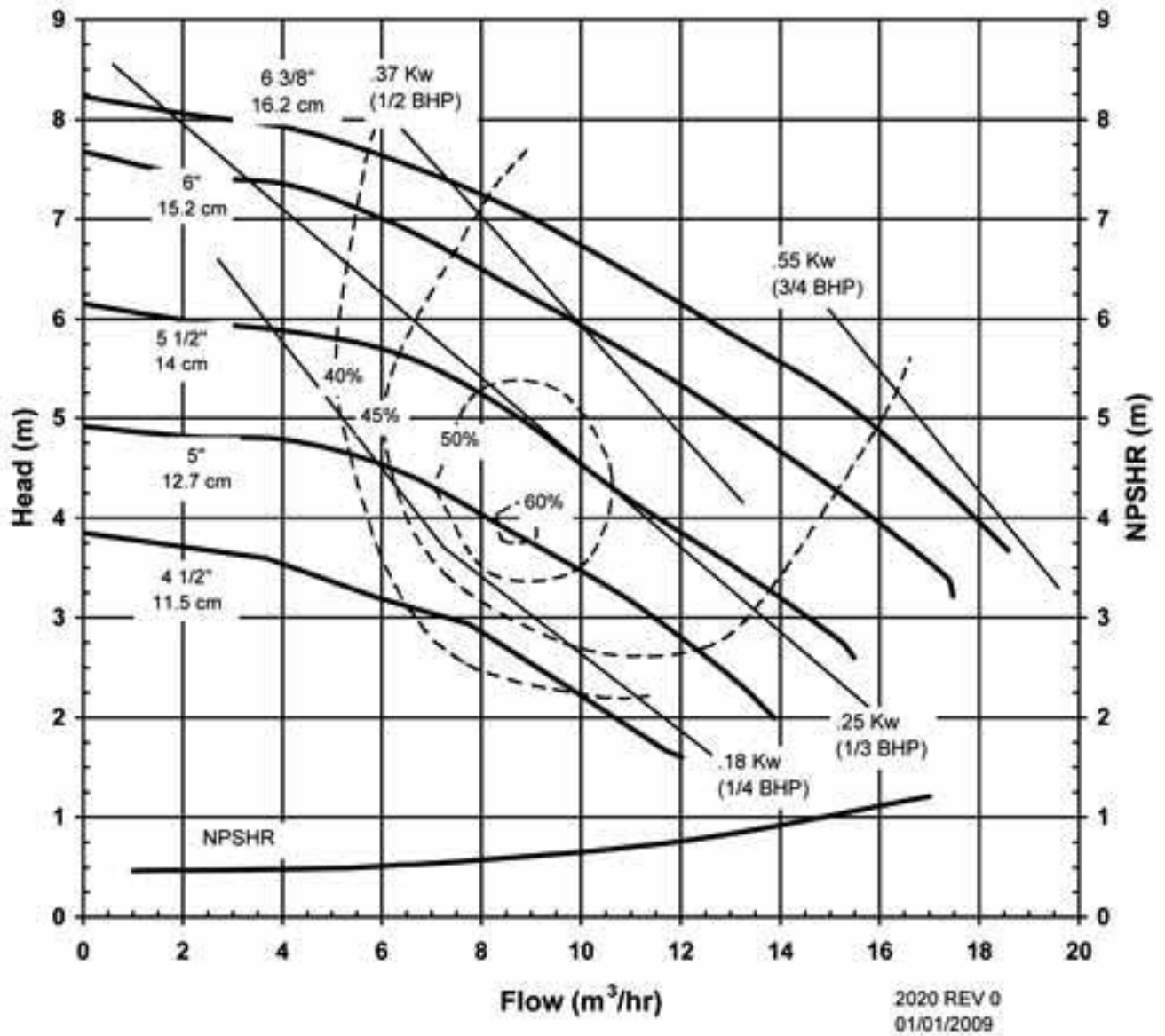



KC SERIES
MULTI-STAGE MODELS
PERFORMANCE CURVE

MODEL MSKC/MSVKC
3450 rpm, 60 Hz
Suction: 1 1/2" FNPT
Discharge: 1" MNPT

- 1. MSKC - 3.88"-3.88"
- 2. MSKC - 3.5"-3.88"
- 3. MSKC - 3.5"-3.5"
- 4. MSKC - 3.19"-3.5"
- 5. MSKC - 3.0"-3.5"

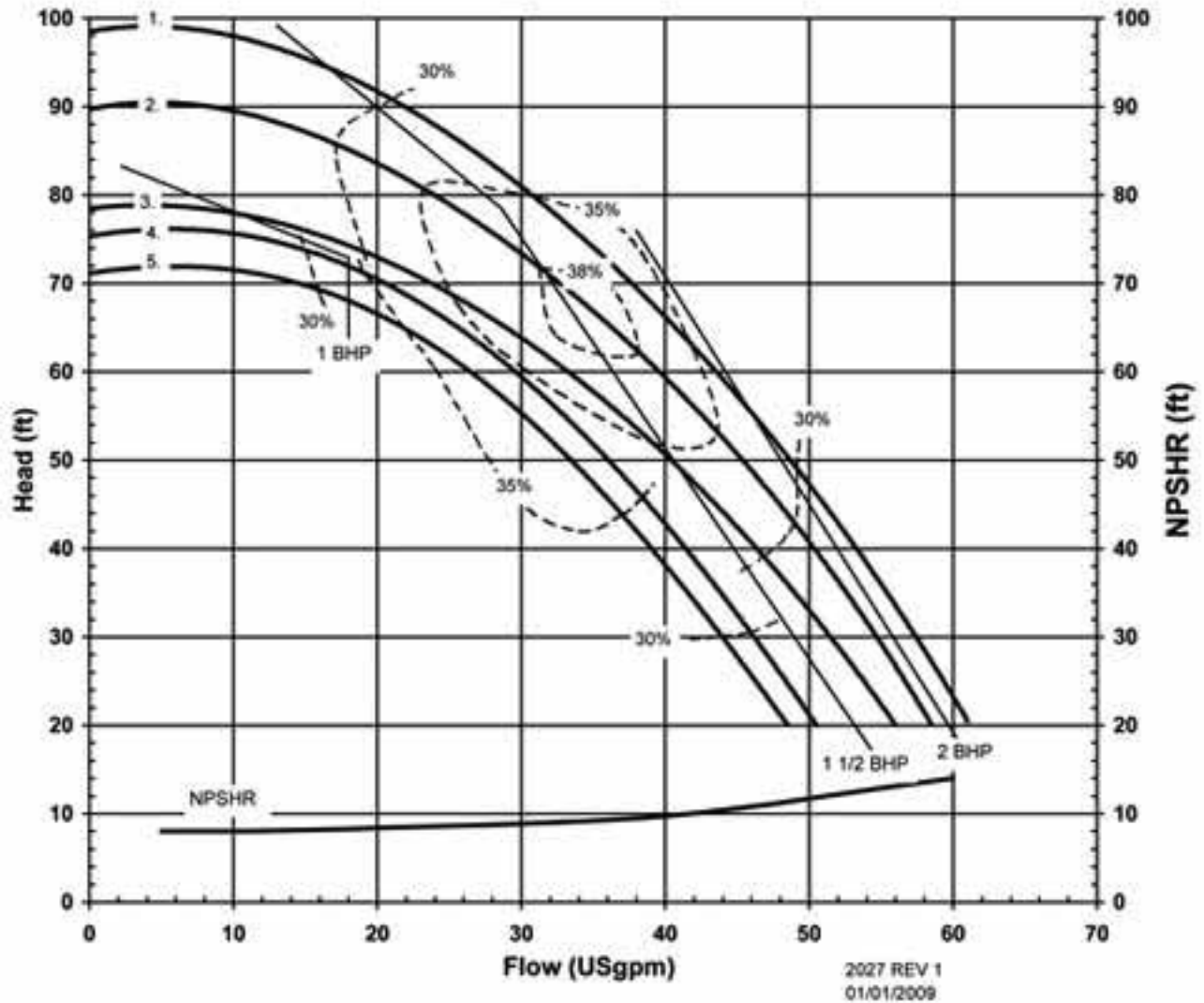



KC SERIES
MULTI-STAGE MODELS
PERFORMANCE CURVE

MODEL MSKC/MSVKC

1725 rpm, 60 Hz

Suction: 1 1/2" FNPT

Discharge: 1" MNPT

- 1. MSKC - 3.88"-3.88"
- 2. MSKC - 3.5"-3.88"
- 3. MSKC - 3.5"-3.5"
- 4. MSKC - 3.19"-3.5"
- 5. MSKC - 3.0"-3.5"

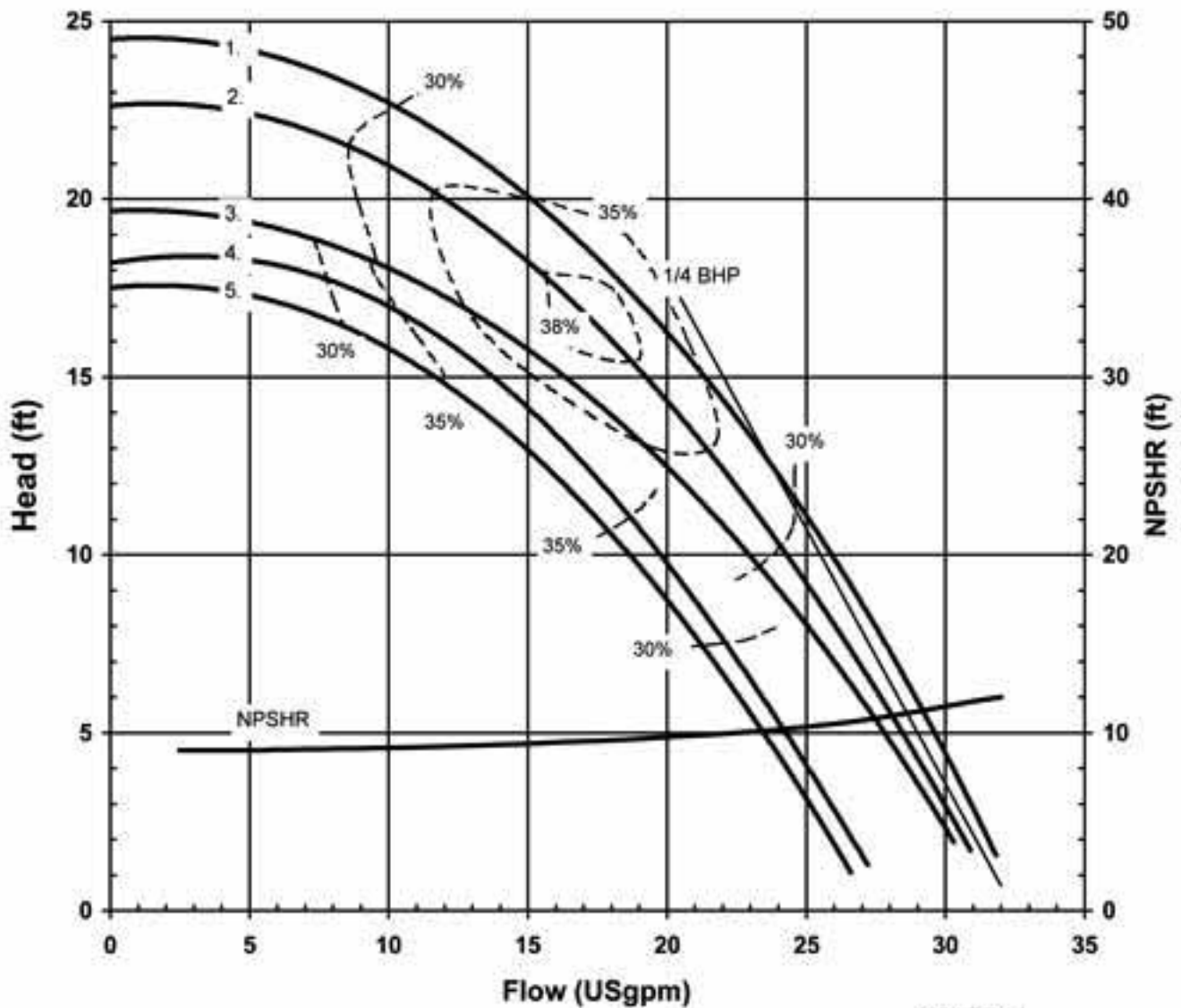

2028 REV 1
101/01/2009



KC SERIES
MULTI-STAGE MODELS
PERFORMANCE CURVE

MODEL MSKC/MSVKC
2900 rpm, 50 Hz
Suction: 1 1/2" FNPT
Discharge: 1" MNPT

- 1. MSKC - 9.86cm -9.86cm
- 2. MSKC - 8.89cm-9.86cm
- 3. MSKC - 8.89cm-8.89cm
- 4. MSKC - 8.10cm-8.89cm
- 5. MSKC - 7.62cm-8.89cm

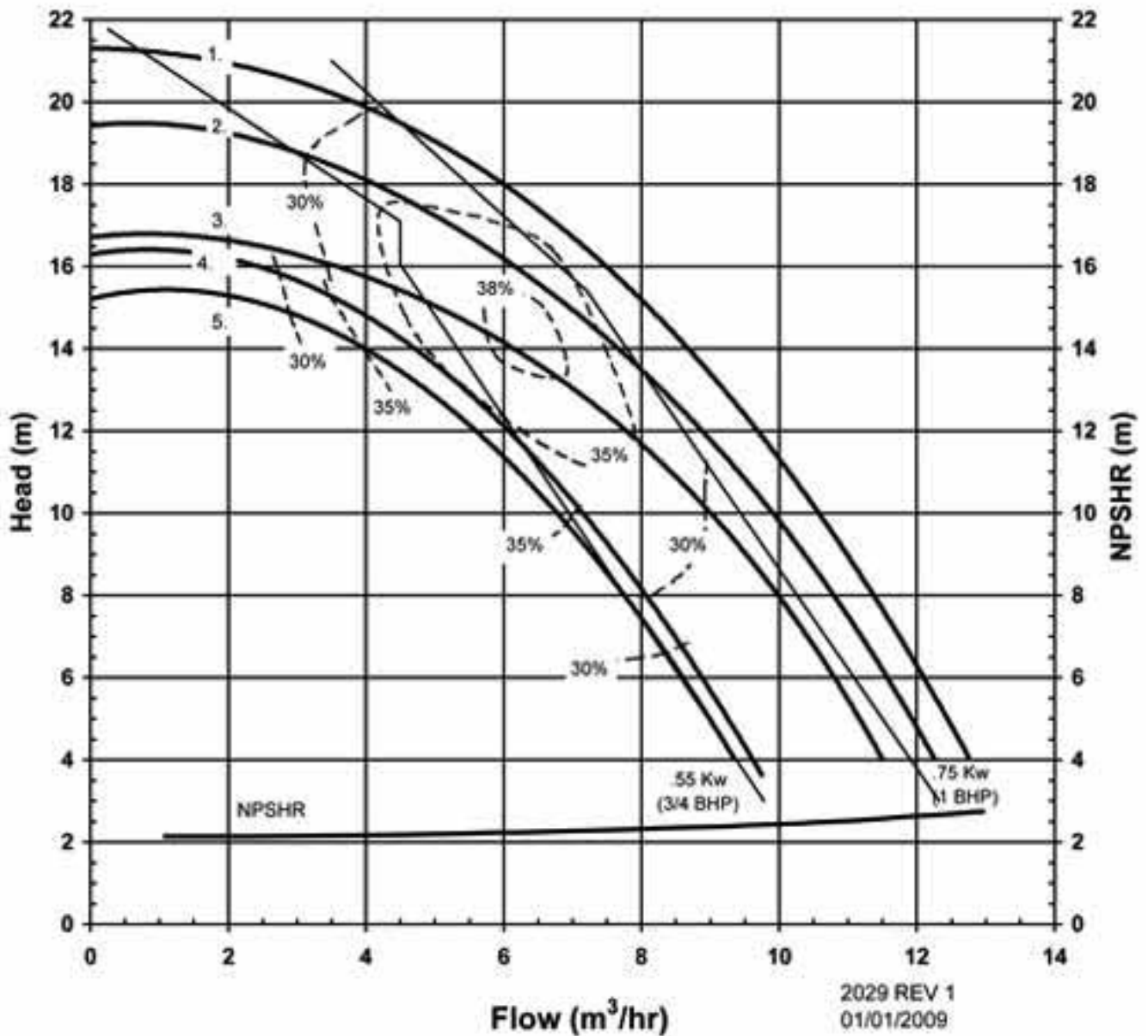

2029 REV 1
01/01/2009



KC SERIES
MULTI-STAGE MODELS
PERFORMANCE CURVE

MODEL MSKC/MSVKC
1450 rpm, 50 Hz
Suction: 1 1/2" FNPT
Discharge: 1" MNPT

- 1. MSKC - 9.86cm-9.86cm
- 2. MSKC - 8.89cm-9.86cm
- 3. MSKC - 8.89cm-8.89cm
- 4. MSKC - 8.10cm-8.89cm
- 5. MSKC - 7.62cm-8.89cm

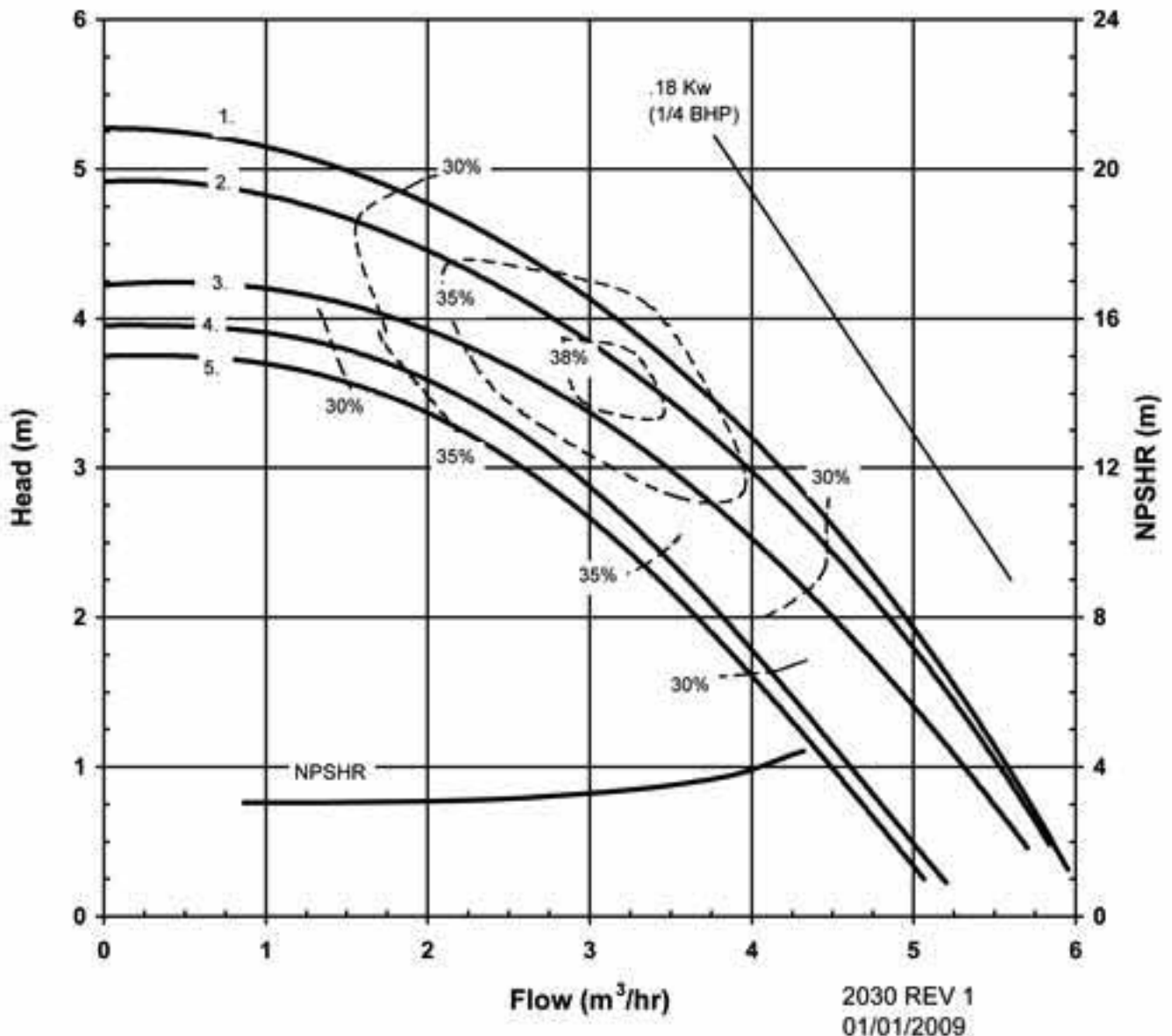

2030 REV 1
01/01/2009