



KC22/32 SERIES Sealless Non-Metallic Centrifugal Pumps

Installation and Maintenance Instructions

ASSEMBLY

Unpack pump from carton and check for shipping damage.

⚠ WARNING: Magnetic field hazard. This pump contains powerful rare earth magnets. When the pump is disassembled (not connected to a motor) and the magnets are exposed, these magnets produce powerful magnetic fields. Individuals with cardiac pacemakers, implanted defibrillators, other electronic medical devices, metallic prosthetic heart valves, internal wound clips (from surgery), metallic prosthetic device or sickle cell anemia must not handle or be in the proximity of the magnets contained inside the pump. Consult a health care provider for specific recommendations before working with this pump.

ATEX COMPLIANT PUMPS

All assembly, installation, and maintenance instructions are the same as standard pumps with the exceptions noted on page 3 under "Safety Precautions for ATEX pumps."

PUMPS WITH MOTORS

Remove shipping plugs and insert from suction and discharge and proceed to installation instructions.

PUMPS WITHOUT MOTORS

1. Remove wet end assembly from box.

⚠ CAUTION: Strong magnets present. Keep metal objects and metallic chips/particles away from pump components.

2. Remove hardware package from box.
3. Install motor adapter (item 6) onto motor with labels at top using items 10 and 11.

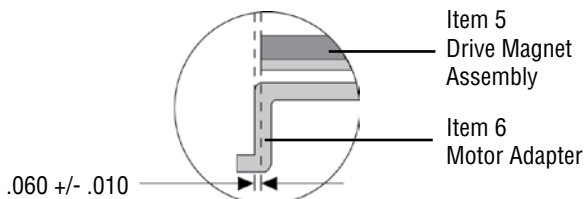

Figure 1

4. Remove drive mag assembly (item 5) from box and slide assembly onto motor shaft making sure shaft key (item 12) is in place. Installation dimension is .060 +/- .010 inches as shown in Figure 1. Tighten 2 set screws (item 5A) to 228 in-lbs. (25.8 N-m).

IMPORTANT: Verify the tightness of the set screws in the drive magnet assembly prior to operation.

⚠ WARNING: Components can slam together from strong magnets. Keep fingers away from area between housing and motor adapter.

5. Gripping the discharge and the side of the impeller housing (note above warning), carefully install the wet end into the motor adapter. Note that the two housing studs (item 15) should be located at 3 and 9 o'clock (for 12 o'clock discharge location) and will go through the motor adapter.
6. Install the 5/16 x 3/4 SS hex bolts (item 7), the 5/16 flat washers (item 9), and the 5/16 hex nuts (item 8) and tighten to 70 in-lbs. of torque using the pattern shown in figure 2.
7. Remove the two-piece shipping plug from the suction.
8. Reach into the suction and spin the impeller to check if it spins freely. If it does not, disassemble and recheck the drive hub installation instructions in step 4.

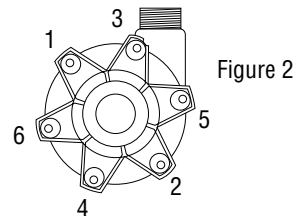

Figure 2

9. Install pump into the system according to the following installation instructions.

INSTALLATION

MOUNTING

Motor or base plate should be securely fastened.

PIPING

1. Support piping near the pump to minimize strain on pump casing.
2. To minimize head loss due to friction:
 - a. Increase pipe size 1 diameter
 - b. Use minimal number of bends
3. Keep pipe bends a minimum of 10 pipe diameters from suction and discharge. For example, if using 2" pipe, first bend should be at least 20" from suction discharge.
4. Position pump as close to liquid source as possible.
5. Maintain a flooded suction.
6. Ensure that piping is leak proof.
7. Install valves on suction and discharge lines (minimum of 10 pipe diameters from pump).
8. For units in suction lift system, install appropriate piping in

discharge to allow priming of pump.

9. The suction valve should be fully open to avoid restricting suction flow.

IMPORTANT: To protect the pump if prime is lost, use one of the following: (1) pressure switch on the discharge; (2) vacuum switch on the suction; (3) a power monitor to monitor motor current.

10. When pumping liquids which may solidify or crystallize, a flush system should be added to the piping. See Figure 3. Install water inlet and outlet valves as shown.

ELECTRICAL

Install motor according to NEC requirements and local electrical codes.

IMPORTANT: To verify correct motor rotation: (1) Install pump into system. (2) Fully open suction and discharge valves. (3) Allow fluid to flow into the pump.

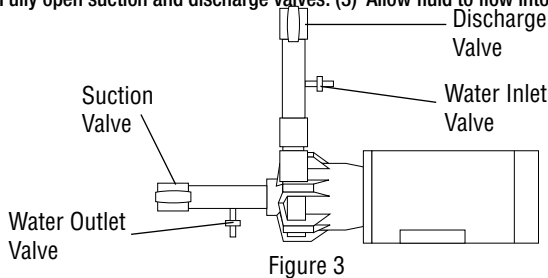

Do not allow pump to run dry (PTFE and ceramic bushings cannot be run dry without damage to pump components). (4) Jog motor (allow it to run for one or two seconds) and observe rotation of motor fan. Correct rotation is clockwise as viewed from motor fan. Refer to directional arrow on pump.

OPERATION

START UP

1. This pump must be filled from a flooded suction tank (gravity) or primed with liquid from an outside source. The KC22/32 are not self-priming.
2. Open the inlet (suction) and discharge valves completely and allow the pump to fill with liquid.
3. Close the discharge valve.
4. Turn the pump on. Slowly open the discharge valve. Adjust the flow rate and pressure by regulating the discharge valve. Do not attempt to adjust the flow with the suction valve.
5. Use of a power monitor is strongly recommended for pumps with ceramic, PTFE or silicon carbide bushings. The power monitor will stop the pump and help prevent damage should the pump run dry. ATEX certified pumps MUST use a power monitor.

SHUT DOWN

Use the following procedure to shutdown the pump.

1. Slowly close the discharge valve.
2. Turn off the motor.
3. Close the suction valve.

FLUSH SYSTEM

1. Fully close suction and discharge valves.
2. Connect water supply to water inlet valve.
3. Connect drain hose to water outlet valve.
4. Open inlet and outlet valves, and flush system until pump is clean (approximately 5 minutes).

MAINTENANCE

DISASSEMBLY

1. Disconnect power. Remove electrical wiring and mounting bolts to floor or base plate.
2. Close suction and discharge valves, and disconnect piping.
3. Remove bolts, nuts and washers (items 7, 8 and 9). Leave the 2 housing studs (item 15) in place until the wet end is removed.
4. Securely clamp or hold motor in place. Remove wet end assembly by inserting both thumbs into pump suction and pulling assembly straight out with a quick motion.

⚠ WARNING: Components can slam together from strong magnets. Keep fingers away from area between housing and motor adapter.

5. Disassemble wet end by removing 2 housing studs and nuts (items 16) which attach barrier (item 4) to impeller housing (item 1). Remove and discard o-ring (item 13).
6. Remove drive magnet assembly by inserting a 3/16" hex wrench into access hole in side of motor adapter and loosening 2 set screws (item 5A). Grasp inside of magnet assembly and pull off of motor shaft.

⚠ CAUTION: Strong magnets present. Keep metal objects and metallic chips/particles away from pump components.

EXAMINATION

1. Check impeller drive bushing (item 3A) and impeller thrust washer (item 2A). If cracked, chipped or scored, then replace. Replace if minimum groove height is less than the minimum height recommended. See Figure 4.
2. Check for loose magnets.

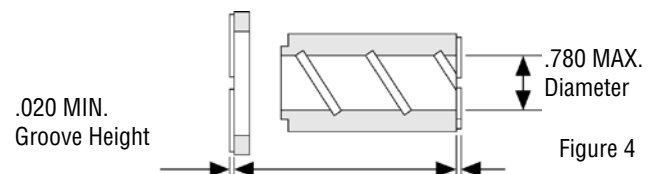

IMPELLER DISASSEMBLY

1. To separate impeller body (item 2) from the impeller drive (item 3), support the body in an arbor press using two 5" minimum spacer blocks.
2. Insert a 1-1/2" diameter plastic or wooden shaft into the impeller eye, and push the drive out of the body. See Figure 5.

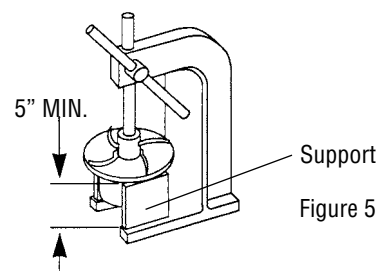

Note: On closed impellers, use two screwdrivers in slots provided to pry apart impeller and impeller drive.

BUSHING AND THRUST RING REPLACEMENT

1. To remove the bushing, place the impeller assembly (items 2 and 3) in an arbor press. Insert a 1" diameter plastic or wooden shaft through the impeller and press bushing out. Refer to Figure 6.

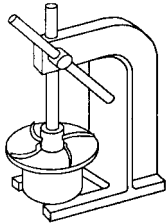

Figure 6

2. To replace bushing, place the impeller assembly (items 2 and 3) on a flat surface with the thrust ring face down (item 2A). Insert the bushing (item 3A), slotted face out, into impeller assembly. Gently push until bushing bottoms out. Bushing should be flush with impeller eye.
3. Impeller thrust ring (item 2A) can be removed from impeller body (item 2) by gently pulling ring from impeller nose.

Note: The thrust ring on the closed impeller must be removed by grasping with a pliers and twisting. Once removed, a new thrust ring is required.

4. To replace thrust ring, align ring (grooved side up) with the inside of the impeller assembly (item 2), and press into place.

Note: Protect face with wood or plastic and avoid tilting ring.

REASSEMBLY

1. Insert impeller assembly (items 2 and 3) into barrier (item 4). Make sure impeller is free of metal chips. Install new O-ring (item 13) onto lip of barrier (item 4).
2. Install impeller housing (item 1) onto barrier (item 4). Insert 2 housing studs and washers (items 15 & 16) long end into back of barrier (item 4) and push through the impeller housing (item 1) until threads are exposed. Install nut and washer (items 8 & 9) and tighten. On the other end of the stud you will find a threaded housing nut (item 16). This nut can be tightened using a pliers or crescent wrench. It is important to leave about 3/4" of thread exposed so nuts and washers can be installed on motor adapter side.
3. Complete reassembly following steps 5, 6, 7 and 8 of "Pumps Without Motors" section on page 1 of these instructions.

CAUTION: If item numbers 14, 9 and 8 are removed from the motor adapter (item 6), it is very important to place a small amount of "Loc-Tite" removable thread locker-242 onto the threads of the socket head cap screw (item 14) before installing back into the nut (item 8). The above procedure is only necessary for the U.S. adapters 184 TC and 213 TC and prevents the parts from working loose during normal operation. Failure to comply may cause damage to the pump!

SAFETY PRECAUTIONS FOR ATEX PUMPS

CAUTION: Proper o-ring material must be chosen for the fluid being pumped. Improper material selection could lead to swelling and be a possible source of leaks. This is the responsibility of the end user.

WARNING: The pump must be checked for leaks on a regular basis. If leaks are noticed, the pump must be repaired or replaced immediately.

WARNING: The pump must be cleaned on a regular basis to avoid dust buildup greater than 5 mm.

WARNING: ATEX pumps must use a power monitor, flow switch, pressure switch or similar device to help protect against dry running, closed discharge valve and decoupling. Any of these conditions could lead to a rise in surface temperature of the pump.

TEMPERATURE CLASSIFICATION

The surface temperatures of the KC ATEX Series pumps depend upon the temperature of the fluid being pumped. The chart below lists different fluid temperatures and the corresponding pump surface temperatures.

Maximum Fluid Temperature	Surface Temperature	Allowable Temperature Class	Surface Temperature
80°F (27°C)	122°F (50°C)	T6	85°C
185°F (85°C)	192°F (89°C)	T4	135°C
220°F (104°C)	248°F (120°C)	T3	200°C

TROUBLESHOOTING

NO FLOW

1. Pump not primed.
2. Discharge head too high. Insufficient NPSH.
3. Suction lift too high.
4. Closed valve.
5. Viscosity too high (magnets uncoupled).

INSUFFICIENT DISCHARGE

1. Air leaks in suction piping.
2. Discharge head higher than anticipated.
3. Suction lift too high or insufficient NPSH. Check also for clogged suction line or clogged foot valve.
4. Foot valve too small.
5. Foot valve or suction open or not submerged enough.

KC 22/32 PARTS DIAGRAM

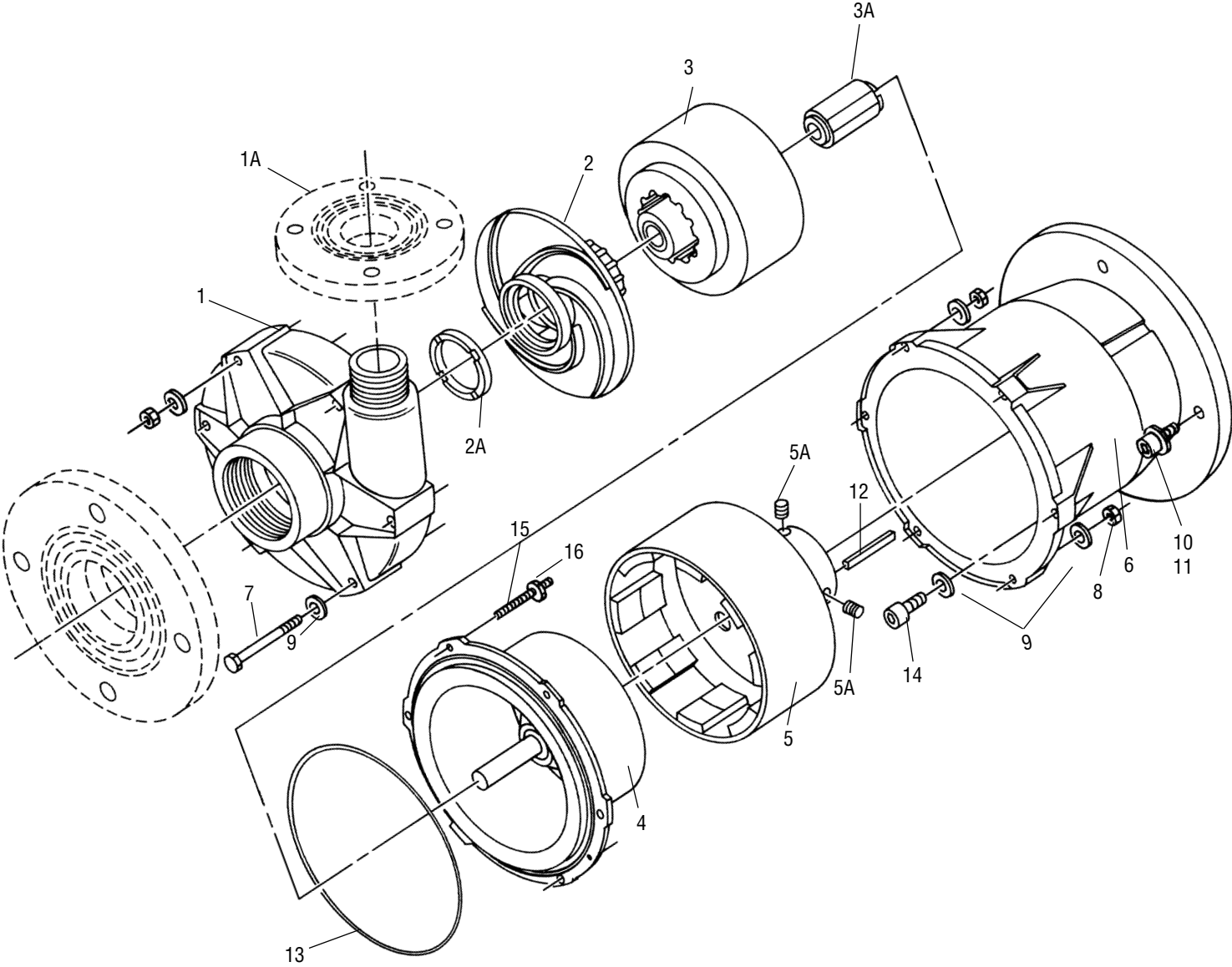

Figure 7

Item	Qty.	Description	Pump Material	
			Polypropylene	PVDF & ATEX
1	1	Housing w/Ceramic Thrust Ring KC22 housing - NPT KC22 housing - BSP KC32 with ceramic thrust ring	A101231-1 A101231-3 A102721-5	A101231-2 A101231-4 A102721-7
1A	1	Ceramic Thrust Ring only (for housing)	J101847	J101847
2	1	Open Impeller Assembly w/Thrust Ring 6" 5-1/2" 5" 4-1/2"	A101235-1 A101235-2 A101235-3 A101235-4	A101235-5 A101235-6 A101235-7 A101235-8
2	1	Closed Impeller Assembly w/Thrust Ring 6-3/8" 6" 5-1/2" 5" 4-1/2"	105569-1 105569-2 105569-3 105569-4 105569-5	105569-6 105569-7 105569-8 105569-9 105569-10
3	1	Open Impeller Drive w/Carbon Bushing	A101944	A101946
	1	Open Impeller Drive w/PTFE Bushing	A101945	A101947
	1	Open Impeller Drive w/Ceramic Bushing	A103231	A103232
	1	Closed Impeller Drive w/Carbon Bushing	105563	105566
	1	Closed Impeller Drive w/PTFE Bushing	105564	105567
	1	Closed Impeller Drive w/Ceramic Bushing	105565	105568
4	1	Barrier Assembly (Includes Ceramic Shaft and Thrust Ring)	A101147-1	A101147-2
	1	Wet End Assembly (Includes Items 1, 2, 3, 4, 13 and 15)	See Base Number in Price List Catalog	

Item	Qty.	Description	Part Number PP, PVDF, ATEX
2A	1	Open Impeller Thrust Ring	J101460
	1	Closed Impeller Thrust Ring	J103899
3A	1	Open Impeller Bushing - Carbon	J101701-1
	1	Open Impeller Bushing - PTFE	J101701-2
	1	Open Impeller Bushing - Ceramic	J101701-3
	1	Closed Impeller Bushing - Carbon	J103917-1
	1	Closed Impeller Bushing - PTFE	106757
	1	Closed Impeller Bushing - Ceramic	J103917
5	1	Drive Magnet Assembly 184 T.C. Frame 213 T.C. Frame 90 Metric Frame 100/112 Metric Frame	A101141-5 A101141-6 A101141-8 A101141-7
5A	2	3/8" x 3/8" S.S. Set Screws	J101084
6	1	Motor Adapter Assembly U.S. 184 T.C. (ATEX N/A) U.S. 213 T.C. (ATEX N/A) Metric 90 Frame ATEX 90 Metric Frame Metric 110/112 Frame ATEX Metric 110/112 Frame	A102045 A102046 A103249 A103249-1 A101788 A101788-1
7	4	5/16" x 3-1/4" Lg. S.S. Hex Bolts	J101357
8	12	5/16" S.S. Hex Nut	J101257
9	18	5/16" S.S. Flat Washers	J101293
10	4	1/2" x 1" Lg. S.S. Hex Bolts U.S. (184 T.C.)	J101359
	4	1/2" x 1-1/2" Lg. S.S. Hex Bolts U.S. (213 T.C.)	J101858
	4	8mm x 30mm Socket Hd. Cap Screw Metric (90 frame)	J103931
	4	8mm x 25mm Socket Hd. Cap Screw, Metric (100/112 frame)	J103234
11	4	1/2" SAE Flat Washer	J101360
12	1	1/4" x 1/4" x 1-1/2" Lg. Key 184 Fr.	M101675
	1	8mm x 8mm x 38mm Lg. Key 90/100/112 Fr.	M101749
13	1	Housing O-Ring Viton	J101085
	1	EPDM	J101086
14	4	5/16" x 1" Lg. Socket Hd. Cap Screw	J101361
15	2	Housing Stud	M101299
16	2	Housing Nut	J103119

INSUFFICIENT PRESSURE

1. Air or gases in liquid.
2. Impeller diameter too small.
3. Discharge head higher than anticipated.

LOSS OF PRIME

1. Leaking suction line.
2. Suction lift too high or insufficient NPSH.
3. Air or gases in liquid.
4. Foreign matter in impeller.
5. Leaking foot valve.

EXCESSIVE POWER CONSUMPTION

1. Head lower than rating. Pumps too much liquid.
2. Specific gravity or viscosity of liquid pumped is too high or higher than that defined in application.

VIBRATION

1. Excessive bushing wear.
2. Drive magnet uncoupled.
3. Loose magnet.
4. Pump cavitation.

WARRANTY

Finish Thompson, Inc. (manufacturer) warrants this pump product to be free of defects in materials and workmanship for a period of one year from date of purchase by original purchaser. If a warranted defect, which is determined by manufacturer's inspection, occurs within this period, it will be repaired or replaced at the manufacturer's option, provided (1) the product is submitted with proof of purchase date and (2) transportation charges are prepaid to the manufacturer. Liability under this warranty is expressly limited to repairing or replacing the product or parts thereof and is in lieu of any other warranties, either expressed or implied. This warranty does apply only to normal wear of the product or components. This warranty does not apply to products or parts broken due to, in whole or in part, accident, overload, abuse, chemical attack, tampering, or alteration. The warranty does not apply to any other equipment used or purchased in combination with this product. The manufacturer accepts no responsibility for product damage or personal injuries sustained when the product is modified in any way. If this warranty does not apply, the purchaser shall bear all cost for labor, material and transportation.

Manufacturer shall not be liable for incidental or consequential

damages including, but not limited to process down time, transportation costs, costs associated with replacement or substitution products, labor costs, product installation or removal costs, or loss of profit. In any and all events, manufacturer's liability shall not exceed the purchase price of the product and/or accessories.

CHEMICAL REACTION DISCLAIMER

The user must exercise primary responsibility in selecting the product's materials of construction, which are compatible with the fluid(s) that come(s) in contact with the product. The user may consult Finish Thompson, Inc. (manufacturer) and/or a manufacturer's representative/distributor agent to seek a recommendation of the product's material of construction that offers the optimum available chemical compatibility.

However neither manufacturer nor agent shall be liable for product damage or failure, injuries, or any other damage or loss arising out of a reaction, interaction or any chemical effect that occurs between the materials of the product's construction and fluids that come into contact with the product's internals.

ORDERING OF SPARE PARTS

Spare parts can be ordered from your local distributor. Always refer to pump model number to avoid error.

OTHER FINISH THOMPSON PRODUCTS

Drum Transfer Pumps are available in sanitary construction, stainless steel, polypropylene and CPVC. Flows to 40 gpm, discharge heads to 80 feet and viscosities to 100,000 cP.

Portable Mixers for turbine mixing and blending handle viscosities to 1,000 cP with gentle, non-vortexing circulation. Available in 316 stainless steel construction.

Centrifugal Pumps in 316 SS, ETFE lined cast iron, polypropylene and PVDF come with a wide variety of sealing materials. Flows to 330 gpm, discharge heads to 130 feet and temperatures to 220°F (104°C).

For more information, contact Finish Thompson Inc.



FINISH THOMPSON INC.

921 Greengarden Road • Erie, PA 16501-1591 U.S.A.
Ph 814-455-4478 • Fax 814-455-8518
Email fti@finishthompson.com • www.finishthompson.com

ORDER FAX 814-459-3460
J102309, Rev. 19, 04/23/09
Literature I.D. Number- FT95-5415

