



FINISH THOMPSON INC.
Drum Pump **Flow Meter**

Model FMBC2000 Series Operating Instructions



Table of Contents

Safety	1
Introduction.....	1
Specifications	1
Features.....	1
Section 1 - Installation	2
Section 2 - Operation	2
Front Panel Display	3
Batch Control Mode	3
Programming Menu Flow Chart.....	4
Calibration	4 - 6
Programming Batch Control	6
Jumper Position	7
Factory Default Chart.....	7
Section 3 - Maintenance	7
Section 4 - Warranty	8
Section 5 - Spare Parts	8

Safety

ALWAYS wear protective clothing, eye protection and follow standard safety procedures when handling corrosive or personally harmful materials.

NEVER use this flow meter with flammable or combustible liquids.

NEVER use this flow meter in a hazardous environment.

ALWAYS verify chemical compatibility with the flow meter and pump materials of construction before operation.

ALWAYS make sure the pump and hose are properly supported.

ALWAYS use a chemically compatible hose rated for the temperature of the product being pumped.

ALWAYS place pump tube in liquid before starting.

Introduction

Thank you for purchasing an FMBC-2000 Series electronic flow meter. The FMBC-2000 Series is designed to measure the flow of a fluid being dispensed from Finish Thompson's PFP, PFM, & PFV drum pumps. In addition, the meter can stop the pump when a predetermined customer adjustable volume is reached (Batch Control Mode). The meter is factory calibrated and displays information on an LCD display. In addition, the meter can be field calibrated to improve accuracy at a given flow rate. There are options for materials of construction and measurement units.

Specifications

Maximum Working Pressure:	35-62 PSIG (2.4 – 4.3 bar)
Maximum Fluid Temperature:	PFM & PFP Models = 160° F (71° C); PFV = 120° F (49° C)
Ambient Temperature Range:	32° to 110°F / 0° to 43° C
Enclosure:	NEMA 4X (IP56)
Sensor/Paddle/Axle Material:	PVDF
O-ring seals:	Viton
Accuracy:	+/-1% of full-scale rate reading; can be field calibrated
Repeatability:	+/-1% of full-scale rate reading
Power Requirements:	15 volt DC from supplied AC transformer (115 or 230 volt options)
Maximum Viscosity:	20 cP/mPas
Maximum Specific Gravity:	1.8

Features

- Easy to read eight digit LCD display
- Installs quickly on PFM, PFP, PFV Series pump tubes with supplied fittings
- Factory calibrated; can be field calibrated using front panel touch buttons
- Minimal maintenance required
- Corrosion resistant PVDF sensor with polypropylene or PVDF body, ABS electronics enclosure
- Weather resistant enclosure
- High accuracy
- Batch control
- Hall effect sensor
- Non-volatile memory stores settings even when power is disconnected

Kit Contents:

- FMBC-2000 Series Meter - prewired
- Flow meter adapter
- Discharge nut
- 1" NPT coupling
- Hose barb adapter

Section 1 - Installation

⚠ WARNING: While wiring the meter, make sure all power is disconnected.

NOTE: Avoid exposing the LCD for prolonged periods to direct sunlight or the life of the LCD may be reduced.

NOTE: Due to many different plug types worldwide, 230-volt versions require the customer to install a compatible male plug on the input cord side (connected to the side of the meter, goes to the electrical supply) and a female plug on the output cord side (connected to the back of the meter and will have the pump motor connected to it). Install the plugs before installing the meter on the pump tube.

Install meter on pump tube

1. Determine which direction the flow meter display is to face. It is bi-directional and can face either to the right or left but must be kept in the upright position.
 2. Wrap Teflon tape on threads of both ends of flow meter (Item 1). Screw Hose Barb Adapter (Item 2) onto discharge end of flow meter. Tighten securely by hand or wrench, being very careful not to over-tighten.
 3. Screw 1" NPT coupling (item 3) onto the other end of the flow meter. Tighten securely by hand or wrench, being very careful not to over-tighten.
 4. Remove discharge nut, spout and o-ring (items 8, 7, 6) from PF discharge. Discard the discharge nut and spout (or save for later use if no longer using the pump with a flow meter). Save the o-ring for use in the next step.
 5. Place the flow meter adapter (item 5) into the discharge nut (item 4) supplied with the flow meter kit. Threads of the adapter will protrude through the front of the discharge nut. Place the o-ring (item 6) inside the discharge nut (item 4). Press down on the o-ring to ensure it is seated in the nut.
 6. Screw discharge nut/adaptor/o-ring assembly onto the discharge of the PF pump tube. Use a wrench to tighten securely but do not over-tighten. This step prevents the adapter from rotating when the flow meter is installed.
 7. Remove display housing (item 9) from molded in-line body by loosening the nut. See figure 1
 8. Grasping the molded in-line body (item 10), screw the flow meter assembly onto the 1" NPT discharge adapter on the PF Series pump tube until tight.
 9. Reinstall the display housing in the molded in-line body and tighten the nut. If the flow meter display is not in the upright position proceed to step 10 for adjustment.
 10. Using a wrench, loosen the discharge nut (item 4) on the discharge of the PF Series tube. Position the flow meter assembly so the display is in the upright position and retighten the discharge nut (while holding the flow meter assembly).
- ⚠ WARNING:** Use chemically compatible hose rated for the temperature of the product being pumped.
11. Attach 1" ID hose to the hose barb located at the discharge end of the flow meter. Secure with a hose clamp.

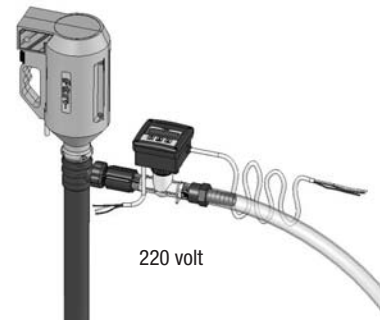
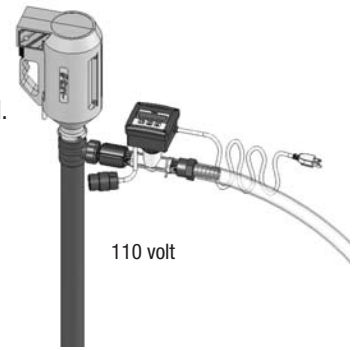

Section 2 - Operation

Theory of Operation



Start the pump motor (in Batch Control Mode the motor is started from the meter front panel). Fluid flowing through the meter causes a paddlewheel to spin. Pulses generated by the spinning paddlewheel are counted and multiplied by scaling factors. The resulting flow rate amounts and total flow amounts are displayed on the LCD readout. Pressing the enter button located on the front panel toggles the display between flow rate and total flow or allows entry into the programming mode. Pressing the clear total button while the total flow value is displayed will return the total to zero. A small icon will light at the bottom of the LCD indicating the mode being displayed. In Batch Control Mode the motor is automatically shut off when the customer adjustable, predetermined set point is reached.

NOTES:

- Depending on the meter purchased, the FMBC-2000 is calibrated for and displays either GPM (US gallons per minute) or LPM (liters per minute).
- The meter is shipped from the factory with power supply transformer.
- The FMBC-2000 Series is factory calibrated to $\pm 1\%$ of full-scale rate reading. Accuracy is based on laboratory testing using a PF Series pump tube.
- Unit is factory calibrated for water. If using a fluid other than water and calibration is required proceed to section "Calibration" on page 4 before proceeding with the steps listed below.
- If flow meter is not going to be used in "Batch Control Mode" and it is desired to use it only as a rate or totalizer meter with manual motor control (motor is turned ON/OFF by the user), plug the drum pump motor into a standard electrical supply (make sure motor is in OFF position before plugging it in). Female plug from the meter is not used.

Front Panel Display Main Menu (not programming mode menu)

Pressing the  button cycles through the main menu screens.



- **First screen is “Rate”** – this displays actual flow rate of the liquid passing through the meter (either gallons per minute or liters per minute depending upon meter).
- **Second screen is “Total”** – this displays the total volume of liquid that has passed through the meter. This total will continue to accumulate until the  button is pressed and the total is reset to zero.
- **Third screen is “Batch Total”** – This keeps track of the total volume (gallons or liters depending upon meter) of liquid that has passed through the meter for the current batch. This number can be reset by pressing the  button. This information can be used to help determine how close you are to reaching the end of the batch. This can be especially helpful on large batch volumes.
- **Fourth screen is “Batch #”** – This keeps track of the total number of batches. This number can be reset by pressing the  button. This could be used for example to determine the number of buckets/pails filled from a drum/barrel.

Batch Control Mode Operation

1. Plug drum pump motor into the female cord plug end (wire comes out of the back of the meter).
2. Plug power supply transformer into the electrical supply.
3. Plug input power (male cord plug connected to the side of the meter) into the electrical supply.
4. Set batch volume (see “Programming Batch Control” Section, on page 6)
5. Insert pump tube into drum or container, turn drum pump switch to “ON” position.
6. To start drum pump motor press the  button. The word “Setpoint” is displayed when the relay is energized. The motor will automatically stop when the customer adjustable volume has been reached and the word “Setpoint” will automatically disappear.

NOTE: Turn drum pump motor switch to the “OFF” position when not in use to prevent accidental activation.

NOTE: Batch can be started and stopped in any “Main Menu Mode”. The user can cycle through each of the four menu options (“Rate”, “Total”, “Batch Total” & “Batch #”) during the batch.

NOTE: To stop the pump before the batch volume is reached either turn the drum pump motor switch to the “OFF” position or press the  button to deactivate the relay. To restart the pump picking up where the pump stopped in the batch, press the  button.

NOTE: To stop the batch before completion and restart the next batch from the beginning, press the  button.

NOTE: If the word “Setpoint” is flashing on the meter, the relay is de-energized and power is NOT passing through the relay to the motor.

Programming Menu Flow Chart

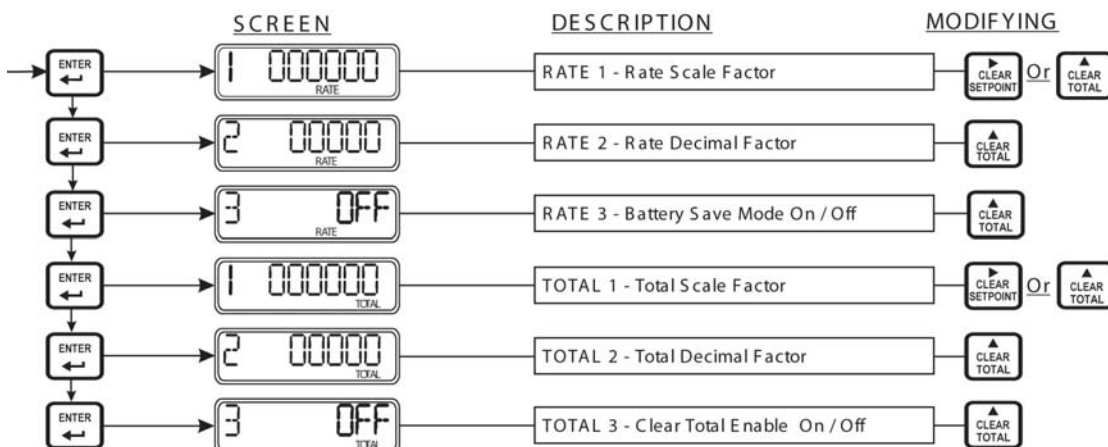

Calibration

While the FMBC-2000 has been calibrated at the factory, field calibration is possible to increase accuracy at a given flow. Use the following steps for field calibration.

NOTE: If the Front Panel Programming has been disabled, the meter cannot be calibrated until the Front Panel Programming has been re-enabled. See “Disabling Front Panel Programming” Section. The factory default setting is “enabled” which allows changes to be made,

NOTE: Calibration requires manual motor control (motor is turned ON/OFF by the user). During the calibration process, plug the drum pump motor into a standard electrical supply (make sure motor is in OFF position before plugging it in). Female plug from the meter is not used during calibration.

Step One – Determine Actual Volume versus Meter Reading

Compare the actual volume of the fluid being pumped with the volume shown on the meter. You can either use a calibrated container or you can use a known weight. In either case, use as large a container as practical (for instance five-gallon versus one-gallon container).

NOTE: Press the  button while in the “Total” main menu to reset the value to zero before starting the calibration process.

Step Two – Determine Multiplier Factor

To use the “volume” process, use the following steps:

- Fill the container until it reaches the known volume mark.
- Divide the known volume by the reading on the meter. Record this multiplier _____.
For example, if using a five-gallon container and the meter reads 5.2 gallons, the multiplier is .96.

To use the “known weight” process, use the following steps:

- Weigh the container. Record this weight _____.
- Fill the container with fluid. Record this weight _____.
- Record the “total” volume of fluid shown on the meter display _____.
- Subtract the weight of the container from the weight recorded in step b to arrive at a net fluid weight _____.
- Determine fluid density. Water weighs approximately 8.33 pounds per US gallon or 1 kg per liter. To determine fluid density (weight per volume unit), multiply the weight of water per gallon or liter by the specific gravity of the fluid (found on MSDS). Record density _____.

For example, the specific gravity on the MSDS for 93% sulfuric acid is shown as 1.84.

$8.33 \text{ pounds per gallon} \times 1.84 = 15.33 \text{ pounds per gallon (density) for 93\% sulfuric acid.}$

- Divide the net fluid weight by the fluid density to determine volume. Record the known volume _____.
For example, the net weight is 41.65 pounds; the fluid is water with a density of 8.33 pounds per gallon;
 $41.65 \text{ divided by } 8.33 = 5 \text{ (gallons)}$
- Divide the known volume by the reading on the meter. Record this multiplier _____.
For example, if using a five-gallon container and the meter reads 5.2 gallons the multiplier is .96.

Step Three – Calculate New Rate Scale Factor

For gallons per minute

Note: Factory default Rate Scale Factor is 18.458

Multiply multiplier factor by factory rate scale factor.

For example, $.96 \times 18.458 = 17.720$

Record the number here _____ and also below in “Step six” part b.

For liters per minute

Note: Factory default Rate Scale Factor is 69.872

Multiply multiplier factor by factory rate scale factor.

For example, $.96 \times 69.872 = 67.077$

Record the number here _____ and also below in “Step six” part b.

Step Four – Calculate new Total Scale Factor

For gallons per minute

Note: Factory default Total Scale Factor is .3076
Take the Rate Scale Factor from Step three and divide by 60.

For example if the Rate Scale factor from Step three is 17.720, the Total Scale Factor is .2953

Record the number here _____ and also below in “Step six” part h.

For liters per minute

Note: Factory default Total Scale Factor is 1.1645
Take the Rate Scale Factor from Step three and divide by 60.

For example if the Rate Scale factor from Step three is 67.077, the Total Scale Factor is 1.1180

Record the number here _____ and also below in “Step six” part h.

Step Five – Enter Programming Menu

To enter programming mode, press and hold the  button on the front of the meter for at least 2 seconds.

Step Six – Enter the Rate Scale Factor and Total Scale Factors

NOTE: Meter automatically exits programming mode after 20 seconds of button inactivity. Any changes made will be lost (new value will not be stored).



a) Press and hold down the  button for at least two seconds

b) Enter the Rate Scale Factor from Step Three.

Rate scale factor from “**Step Three**”

c) Press the  button to select the digit to be modified. The selected digit will blink. The decimal point will blink after all the numbers have been cycled through. Do not change the decimal point.

d) Press the  button to modify the selected digit. Repeat the process until all digits have been modified.

e) When finished, press the  button. The screen changes to the RATE 2 (“2” is in left corner of display) screen. Do not make changes on this screen. Go to the next screen by pressing the  button.

f) The screen changes to the RATE 3 (“3” is in left corner of display) screen. Do not make changes on this screen. Go to the next screen by pressing the  button.

g) The screen changes to the Total 1 (“1” is in left corner of display) screen. Enter the Total Scale Factor from Step four.

h) Total scale factor from “**Step Four**”

i) Press the  button to select the digit to be modified. The selected digit will blink. The decimal point will blink after all the numbers have been cycled through. Do not change the decimal point.

j) Press the  button to modify the selected digit. Repeat the process until all digits have been modified.

k) To save setting and exit Programming Mode, press and hold the  button for at least two seconds.

NOTE: There are two additional screens that are not required for calibration that have been skipped by exiting at this point.

NOTE: To verify that the meter is properly calibrated, repeat Step one. If not, repeat calibration process. Return the Rate Scale Factor and Total Scale Factor to factory settings prior to repeating steps one through six. Once calibration process is complete, proceed to “Batch Control Mode Operation on page 3.

Programming Batch Control

The FMBC-2000 has a SPDT relay located inside the meter enclosure that controls the drum pump motor. When the required customer adjustable volume of liquid has passed through the meter, the relay deactivates and power to the drum pump motor is terminated.

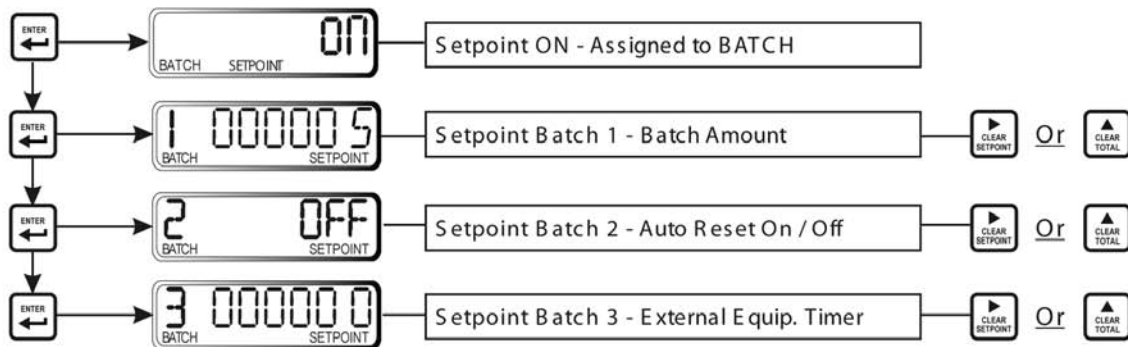

1. To set batch amount value, press and hold down the  button for at least two seconds.

2. Press the  button seven times to scroll through screens to arrive at Batch Amount screen.

NOTE: Batch default volume is factory set for 5 US gallons or 20 liters depending upon measurement system model.

NOTE: The actual volume pumped may exceed the setpoint due to the motor continuing to turn the pump shaft for a brief period after the power is terminated to the motor. For example, on a five-gallon batch setting, the actual volume pumped would be approximately 5.15 gallons versus 5.00. The meter WILL display the actual volume pumped. The batch setpoint can be set slightly below the actual desired batch size to compensate for this overrun.

3. Press the  button to select the digit to be modified. The selected digit will blink.

4. Press the  button to modify the selected digit. Repeat the process until all digits have been modified.

5. The decimal point will blink after all the numbers have been cycled through. Press the  button to move the selected decimal place location.

6. To save setting and exit Programming Mode, press and hold the  button for at least two seconds.

NOTE: There are two additional screens that are not required for batch control that have been skipped by exiting at this point.

Disabling the Front Panel Programming Mode:

The programming model can be disabled by using a jumper to prevent changing of parameters, for instance, after the meter has been field calibrated.

To disable the Front Panel Programming Mode, remove four Phillips head screws from front of meter. Remove cover to expose meter internals. Install jumper on J2 ("P" is also underneath). See Figure 1.

Figure 1

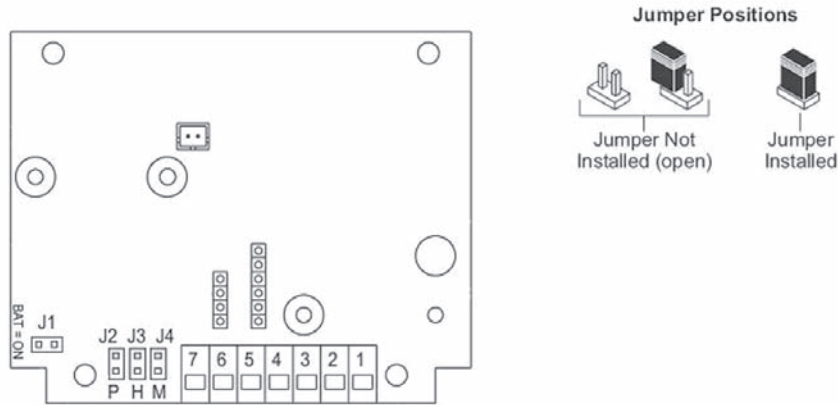

Figure 2 - Factory Default Chart

1 000000 RATE	RATE 1 - Rate Scale Factor	18.458 (GPM) / 69.872 (LPM)
2 000000 RATE	RATE 2 - Rate Decimal Factor	.00
3 OFF RATE	RATE 3 - Battery Save Mode On / Off	OFF
1 000000 TOTAL	TOTAL 1 - Total Scale Factor	.3076 (Gal.) / 1.1645 (L.)
2 000000 TOTAL	TOTAL 2 - Total Decimal Factor	.00
3 OFF TOTAL	TOTAL 3 - Clear Total Enable On / Off	ON
OFF SETPOINT	SETPOINT MODE ASSIGN - on rate / on batch / off	ON BATCH
1 000000 1 BATCH SETPOINT	Setpoint Batch 1 - Batch Amount	5.00 Gal. / 20.00 (Liters)
2 OFF BATCH SETPOINT	Setpoint Batch 2 - Auto Reset On / Off	OFF
3 000000 1 BATCH SETPOINT	Setpoint Batch 3 - External Equip. Timer	000

Section 3 - Maintenance

The FMBC-2000 Series was engineered for low maintenance; however, some conditions will cause increased wear on the paddle and/or possible damage to the unit. Damage caused by corrosives incompatible with the meters materials of construction or abrasive fluids is not covered under warranty.

- Periodically remove the sensor from the molded in-line body and inspect for signs of wear and obstructions. Clean the paddle of any foreign material. Inspect the o-rings for any sign of wear, swelling, cracking or discoloration. Replace if necessary.
- The meter is designed to withstand minor condensation inside the enclosure. Prolonged excessive moisture inside the enclosure, due to high humidity conditions, may damage the meter. Reduce the humidity or move the meter to a cool, dry location.

Section 4 - Warranty

Finish Thompson, Inc (manufacturer) warrants this product to be free of defects in materials and workmanship for a period of one year from date of purchase by original purchaser. If a warranted defect, which is determined by manufacturer's inspection, occurs within this period, it will be repaired or replaced at the manufacturer's option, provided (1) the product is submitted with proof of purchase date and (2) transportation charges are prepaid to the manufacturer. Liability under this warranty is expressly limited to repairing or replacing the product or parts thereof and is in lieu of any other warranties, either expressed or implied. This warranty does apply only to normal wear of the product or components. This warranty does not apply to products or parts broken due to, in whole or in part, accident, overload, abuse, chemical attack, tampering, or alteration. The manufacturer accepts no responsibility for product damage or personal injuries sustained when the product is modified in any way. If this warranty does not apply, the purchaser shall bear all cost for labor, material and transportation.

Manufacturer shall not be liable for incidental or consequential damages including, but not limited to process down time, transportation costs, costs associated with replacement or substitution products, labor costs, product installation or removal costs, or loss of profit. In any and all events, manufacturer's liability shall not exceed the purchase price of the product and/or accessories

Section 5 - Spare Parts

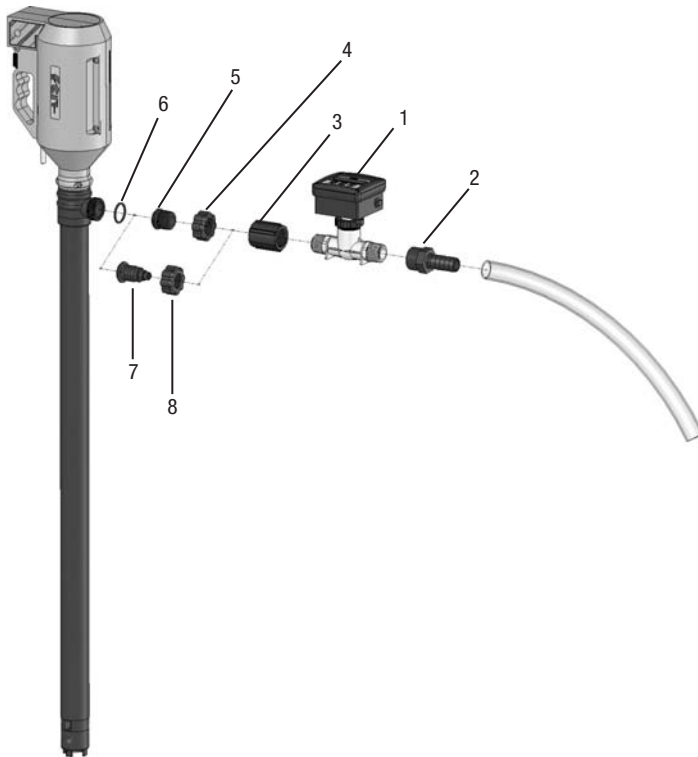

Item Number	Qty.	Description	Part Number
2	1	Hose barb adapter, polypropylene	106601
2	1	Hose barb adapter, PVDF	106601-1
3	1	1" NPT coupling, polypropylene	106600
3	1	1" NPT coupling, PVDF	106610
4	1	Discharge nut, polypropylene	106622
4	1	Discharge nut, PVDF	106622-1
5	1	Flow meter adapter, polypropylene	106599
5	1	Flow meter adapter, PVDF	106599-1
6	1	O-ring, Viton	J100991



FINISH THOMPSON INC.

921 Greengarden Road • Erie, PA 16501-1591 U.S.A.
 Ph 814-455-4478 • Fax 814-455-8518
 Email fti@finishthompson.com • www.finishthompson.com

Literature ID No. FT08-1017
 Part Number 106761