



DB6, 6H, 7, 8, 9, 10 Series Centrifugal Pumps

Assembly, Installation and Operation Manual





FINISH THOMPSON INC.

921 Greengarden Road • Erie, PA 16501-1591 U.S.A.
Ph 814-455-4478 • Fax 814-455-8518
Email ftj@finishthompson.com • www.finishthompson.com

EU Declaration of Conformity



Finish Thompson Inc. hereby declares that the following machine(s) fully comply with the applicable health and safety requirements as specified by the EC Directives listed. The product may not be taken into service until it has been established that the drive motor for the centrifugal pump complies with the provisions of all relevant EC Directives. The complete product complies with the provisions of the EC Directive on machinery safety provided motors carry CE marking.

This declaration is valid provided that the devices are fully assembled and no modifications are made to these devices.

Type of Device:
Centrifugal Pumps

Models:

AC/AK/AV - 400/500/600/800	DB-3/4/5/5.5/6/6H/7/ 8/9/10/11/15/22	GP-11/22/32
KC-3/4/5/5.5/6/6H/8/10/11/22/32 SP-10/11/15	MSKC UC-1516/1518/326	MSVKC VKC-5.5/6/6H/7/8/10

EC Directives:

Machinery Safety (2006/42/EC)

Applied Harmonized Standards:

EN ISO 12100 Part 1
EN ISO 12100 Part 2
EN 809

Manufacturer:

Finish Thompson Inc.
921 Greengarden Road
Erie, Pennsylvania 16501-1591 U.S.A

Signed,

President

April 19, 2010

Person(s) Authorized to Compile Technical File: Michael Smith Engineers Limited
Oaks Road, Woking, Surrey
GU21 6PH, UK
Telephone: 01483 771871

Table of Contents

Important Information - Read Me First	
Model Number/Serial Number.....	1
Important Notice	1
Chemical Reaction Disclaimer	1
Safety Precautions	1
Installation/Operation Precautions.....	2
Safety Precautions for ATEX Pumps.....	2
Temperature Classification	2
DB6 - 10 Capabilities.....	2
Minimum Flow Rate.....	2
Maximum Motor Power.....	2
Unpacking and Inspection	3
Section I - Assembly.....	3
Pumps with Motors	3
Pumps without Motors.....	3
Section II - Installation	
Mounting.....	4
Piping.....	4
Motor/Electrical.....	4
Section III - Start-up and Operation.....	4
Shutdown	4
Flush Systems	5
Optional Drain Installation.....	5
Section IV - Maintenance	
Recommended Maintenance schedule.....	5
Section V - Disassembly	5
Outer Drive Replacement	6
Thrust Ring Replacement	6
Bushing Replacement	6
Section VI - Reassembly	6-7
Section VII - Troubleshooting	7
Section VIII - Warranty	7
Part Number Explanation	8
Spare Parts Diagram	9
Spare Parts List.....	10-12
Impeller Assemblies	13

NOTE: Maintenance videos are now available on-line at www.finishthompson.com.



FTI Contacts:

Tech Service: 800-888-3743 or techservice@finishthompson.com
Order Fax: 814-459-3460 or 814-455-8518
Sales: 814-455-4478; 800-934-9384 (U.S. & Canada)

IMPORTANT INFORMATION - READ ME FIRST!

Model Number and Serial Number

Record the model number and serial number below for future reference. This is important information when ordering replacement parts or when technical assistance is required. The numbers are found on a label located on the motor adapter.

MODEL NUMBER = _____

SERIAL NUMBER = _____

IMPORTANT NOTICE

U.S. Export Administration Regulations, pursuant to ECCN 2B350, prohibit the export or reexport to certain enumerated countries of sealless centrifugal pumps in which all wetted materials are constructed from fluoropolymers without first applying for and obtaining a license from the U.S. Bureau of Industry and Security (BIS). This affects all Finish Thompson magnetic-drive pumps constructed from PVDF or lined with ETFE. Please contact the BIS (www.bis.doc.gov) or Finish Thompson with questions regarding the Regulations or a list of the countries to which they apply.

Chemical Reaction Disclaimer

The user must exercise primary responsibility in selecting the product's materials of construction, which are compatible with the fluid(s) that come(s) in contact with the product. The user may consult Finish Thompson, Inc. (manufacturer) and a manufacturer's representative/distributor agent to seek a recommendation of the product's material of construction that offers the optimum available chemical compatibility.

However neither manufacturer nor agent shall be liable for product damage or failure, injuries, or any other damage or loss arising out of a reaction, interaction or any chemical effect that occurs between the materials of the product's construction and fluids that come into contact with the product's components.

Safety Precautions

⚠ WARNING: READ THIS MANUAL COMPLETELY BEFORE INSTALLING AND OPERATING THIS UNIT. FAILURE TO FOLLOW THESE PRECAUTIONS CAN RESULT IN SERIOUS INJURY OR DEATH.

⚠ WARNING: Magnetic field hazard: This pump contains powerful magnets. Exposed magnets (pump not connected to motor) produce powerful magnetic fields. Individuals with cardiac pacemakers, implanted defibrillators, other electronic medical devices, metallic prosthetic heart valves, internal wound clips (from surgery), metallic prosthetic devices or sickle cell anemia must not handle or be in the proximity of the magnets contained inside the pump. Consult a health care provider for specific recommendations before working with this pump.

⚠ WARNING: Magnetic force hazard. This pump should only be disassembled and assembled using the recommended procedures. The magnetic attraction is powerful enough to rapidly pull the motor end and the wet end together. Do not place fingers between the mating surfaces of the motor and wet ends to avoid injuries. Keep the drive magnet and impeller assembly away from metal chips or particles, items with magnetic stripes like credit cards and magnetic computer media such as floppy discs and hard drives.

⚠ WARNING: When pumping flammable or combustible liquids with a DB Series pump it is important to follow these guidelines:

1. You must use a PVDF pump. PVDF has conductive carbon fibers added which allow it to be grounded when installed in a properly grounded piping system or when a properly installed grounding strap is attached to a housing bolt. If PVDF is not compatible with the liquid being pumped, you should consider an ETFE lined UC Series magnetic drive pump.
2. You must select the non-sparking (Ns) bronze bump ring option. The non-sparking ring is pressed into the clamp ring or motor adapter and prevents sparking should the motor bearings fail and the outer mag drive assembly runs out of round.
3. You must select an explosion-proof FTI motor or provide your own explosion-proof motor.

When pumping non-flammable or non-combustible liquids in a hazardous area using a DB Series pump, it is important to take these guidelines:

1. You must select the non-sparking (Ns) bronze bump ring option. The non-sparking ring is pressed into the clamp ring or motor adapter and prevents sparking should the motor bearings fail and the outer mag drive assembly runs out of round.
2. You must select an explosion-proof FTI motor or provide your own explosion-proof motor.

⚠ WARNING: Hot surfaces. This pump is capable of handling liquids with temperatures as high as 220° F (104° C). This may cause the outer areas of the pump to become hot as well and could cause burns.

⚠ WARNING: Rotating Parts. This pump has components that rotate while in operation. Follow local safety standards for locking out the motor from the power supply during maintenance or service.

⚠ WARNING: Chemical Hazard. This pump is used for transferring many types of potentially dangerous chemicals. Always wear protective clothing, eye protection and follow standard safety procedures when handling corrosive or personally harmful materials. Proper procedures should be followed for draining and decontaminating the pump before disassembly and inspection of the pump. There may be small quantities of chemicals present during inspection.

⚠ WARNING: The pump and associated components are heavy. Failure to properly support the pump during lifting and movement could result in serious injury or damage to the pump and components.

⚠ WARNING: Never run pump at less than minimum flow or with the discharge valve closed. This could lead to pump failure.

Installation/Operation Precautions

⚠ CAUTION: This pump should never be operated without liquid in the casing. It is recommended that run dry protection be used. Optional electronic power monitors are available to help protect against run dry. If the pump has a PTFE, ceramic or silicon carbide bushing, IT CANNOT BE RUN DRY WITHOUT CAUSING DAMAGE TO THE PUMP. However, the pump can operate without liquid in the casing if the pump has a carbon bushing. The exact length of time the pump can operate dry with a carbon bushing varies with operating conditions and the environment.

⚠ CAUTION: Never start or operate with a closed suction valve. Never operate with a closed discharge valve.

⚠ CAUTION: Always provide adequate NPSHa (net positive suction head available). It is recommended to provide at least 2 feet (61 cm) above the NPSHr (net positive suction head required).

⚠ CAUTION: If pump is used on variable speed drive, do not exceed the frequency for which the pump was designed (for example, if the pump is a 50 Hz model, do not exceed 50 Hz).

Safety Precautions for ATEX Pumps

⚠ CAUTION: Proper o-ring material must be chosen for the fluid being pumped. Improper material selection could lead to swelling and be a possible source of leaks. This is the responsibility of the end user.

⚠ WARNING: The pump must be checked for leaks on a regular basis. If leaks are noticed, the pump must be repaired or replaced immediately.

⚠ WARNING: The pump must be cleaned on a regular basis to avoid dust buildup greater than 5 mm.

⚠ WARNING: ATEX pumps must use a power monitor, flow switch, pressure switch or similar device to help protect against running dry, closed discharge valve and decoupling. Any of these conditions could lead to a rise in surface temperature of the pump.

Temperature Classification

Fluid Temperature	Maximum Surface Temperature	Temperature Class	Maximum Allowable Surface Temperature
90° F (32° C)	125° F (52° C)	T6	85° C
180° F (82° C)	174 ° F (81° C)	T4	135° C
220° F (104° C)	200° F (93° C)	T4	135° C

DB6, 6H, 7, 8, 9,10 Capabilities

- Maximum Working Pressure: 80 psi (5.5 bar)
- Maximum Viscosity: 150 cP
- Maximum Temperature: Polypropylene -180° F (82° C); PVDF – 220° F (104° C)
Note: Maximum temperature is application dependent. Consult a chemical resistance guide or the chemical manufacturer for chemical compatibility and temperature limits.
- Solids: Maximum particle size is 100 microns for slurries and 1/64" (.4 mm) for infrequent particles. Maximum hardness is 80 HS. Maximum concentration is 10% by weight. If solids are being pumped, it is recommended that the pump have either ceramic or for best results, silicon carbide components. Pumping solids may lead to increased wear.

Minimum Allowable Flow Rate

Do not allow the flow rate to drop below the minimum flow rate listed in the chart below.

3450 rpm	1725 rpm	2900 rpm	1450 rpm
1/2 gpm (1.9 lpm)	1/4 gpm (.95 lpm)	1.9 lpm (1/2 gpm)	.95 lpm (1/4 gpm)

Maximum Allowable Motor Power

Do not exceed the maximum power rating for the pump coupling. Standard coupling for the DB6, 6H & 7 is 6-pole; standard coupling for the DB8, 9 & 10 is 8-pole.

- 6-pole coupling = 1/2 horsepower (0.37 kW)
- 8-pole coupling = 1 horsepower (0.75 kW)
- 10-pole coupling = 2 horsepower (1.50 kW)

Unpacking and Inspection

Unpack the pump and examine for any signs of shipping damage. If any damage is detected, save the packaging and notify the carrier immediately.

Section I - Assembly



Pumps with Motors

Proceed to Installation Section

Pumps Without Motors

Tools Required:

Metric socket or wrench set, 9/16" socket or wrench and 3/16" Allen Wrench (NEMA motors only)

1. Remove the pump, drive magnet assembly and hardware package from the carton.

CAUTION: Keep away from metallic particles, tools and electronics. Drive magnets MUST be free of metal chips.

WARNING: Keep the drive magnet away from the open end of the motor adapter and barrier. Strong magnetic attraction could allow the drive hub to enter the motor adapter resulting in injury or damage.

2. Place motor on the fan end. See figure 1.

NOTE: For 56C/145TC frame motors go to step 4.

3. Install the motor adapter flange (item 14) on motor face using bolts, lock washers and flat washers (items 27, 28, 29). See figure 2.

Torque bolts to the following:

- 63 frame (M5) = 30 in-lb (3.4 N-m)
- 71 frame (M6) = 90 in-lb (10.2 N-m)
- 80 frame (M6) = 90 in-lb (10.2 N-m)

NOTE: 63/71 B14 adapter flange is reversible. Install 63/71 B14 adapter so that proper motor flange size is facing motor.

NOTE: Apply anti-seize compound on the threads of the bolts.

4. Coat the motor shaft with anti-seize compound. Insert key supplied with motor into keyway on motor shaft. See figure 3.

NOTE: Make sure the motor shaft is clean and free of burrs. The outer drive is precision machined and has a bore tolerance of +.0005/-0 inch.

5. Slide the outer drive magnet assembly (item 13) onto the motor shaft until the motor shaft contacts the snap ring in the bore of the drive. See figures 4 & 5.



Figure 4



Figure 5



Figure 1



Figure 2



Figure 3

6. Secure the drive on the motor shaft.

WARNING: Be careful, magnets will try to attract tools.

Metric Motors: Secure the drive to the motor shaft using bolt, lock washer and flat washer (items 21, 22, 23). Thread the bolt into the end of the motor shaft (while holding the outer drive to prevent it from turning). See figure 6.

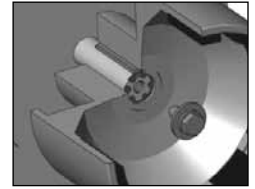

Figure 6

Tighten the bolt to the following:

- 63 frame (M4) = 15 in-lb (1.7 N-m)
- 71 frame (M5) = 30 in-lb (3.4 N-m)
- 80 frame (M6) = 90 in-lb (10.2 N-m)
- 90 frame (M8) = 130 in-lb (14.7 N-m)

NEMA Motors: Install set screws (item 13B) into threaded holes on the side of the outer drive magnet assembly. Using a 3/16" Allen wrench, tighten to 228 in-lbs (25.8 N-m). See figure 7.

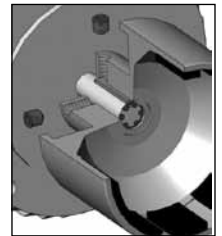

Figure 7

7. Install the pump end on the motor/drive magnet assembly. With the motor/outer drive magnet assembly in a horizontal position, securely clamp to the workbench.

Note: If the pump has the optional o-ring sealing option (available on 56C and 145 frame pumps only), install the o-ring (item 12) in the groove in the motor adapter (motor end).

Carefully slide the pump onto the drive magnet assembly. The last couple of inches (5 cm) before the pump reaches the motor will have STRONG magnetic attraction between the pump and outer drive magnet assembly. See figure 8.

8. Secure the pump to the motor with (4) 3/8" bolts, lock washers and flat washers (items 24, 25, 26). Tighten to 60 in-lb (6.8 N-m). See figure 9.

Note: 63/71 frame require 3/8-16 hex jam nuts. Place nut in and secure pump to motor.

Note: Apply anti-seize compound on the threads of the bolts.



Figure 8



Figure 9

9. Rotate the motor fan to ensure that there is no binding in the pump.

10. Proceed to Installation Section.

Section II – Installation

Mounting

Motor feet should be securely fastened to a solid foundation.

Note: Shims are required for the motor feet on ALL 63, 71 and 80 frame motors and 90 frame B5 motors.

Instructions for horizontal discharge installation:

The pump ships from the factory with the discharge in a vertical orientation. These instructions allow a horizontal discharge.

1. Remove (4) clamp ring bolts, lock washers and flat washers (items 20, 19, 18). Rotate clamp ring clockwise 90° from the motor end.
2. Reinstall (4) clamp ring bolts, lock washers and flat washers. Tighten to 60 in-lb (6.8 N-m).

Note: If the pump has the optional o-ring sealing option (available on 56C and 145 frame pumps only), make sure o-ring is properly seated in the groove after the clamp has been rotated.

Note: When the pump discharge is in a horizontal configuration, the motor must be shimmed to raise the front of the pump to avoid interference.

Piping

 **Caution:** The NPSH available must be greater than the NPSH required. Filters, strainers and any other fittings in the suction line will lower the NPSH available and should be calculated into the application.

- Install the pump as close to the suction source as possible.
- Support the piping independently near the pump to eliminate any strain on the pump casing. In addition, the piping should be aligned to avoid placing stress on the pump casing.
- The suction side of the pump should be as straight and short as possible to minimize pipe friction.
- Keep bends and valves at least ten pipe diameters away from the suction and discharge.
- The suction line should be at least as large as the suction inlet port or one pipe size larger so that it does not affect the NPSHa. Do not reduce the suction line size.
- The suction line should not have any high spots. This can create air pockets. The suction piping should be level or slope slightly upward to the pump.
- A check valve and control valve (if used) should be installed on the discharge line. The control valve is used for regulating flow. An isolation valves on the suction and discharge are used to make the pump accessible for maintenance. The check valve helps prevent the pump against damage from water hammer. This is particularly important when the static discharge head is high.
- If flexible hose is preferred, use a reinforced hose rated for the proper temperature, pressure and chemical resistance to the fluid being pumped.
- The suction valve must be completely open to avoid restricting the suction flow.
- It is advisable to install a flush system in the piping to allow the pump to be flushed before the pump is removed from service.

Note: The pump is provided with a provision for a customer

installed ¼” drain in the impeller housing. See the Drain Installation Section for details.

- For units in a suction lift system, install appropriate piping in the discharge to allow priming of the pump (DB models are not self-priming).
- When installing pumps with flanges, we recommend the use of low seating stress gaskets such as Gore-Tex® or Gylon® (expanded PTFE)

Motor/Electrical

Install the motor according to NEC requirements and local electrical codes. The motor should have an overload protection circuit.

Wire the motor for clockwise rotation when facing the fan end of the motor.

 **CAUTION:** Do not operate the pump to check rotation until the pump is full of liquid.

Check all electrical connections with the wiring diagram on the motor. Make sure the voltage, frequency, phase and amp draw comply with the supply circuit.

If utilized, verify that the power monitor has been properly installed according to the manufacturers instructions.

To verify correct rotation of the motor:

1. Install the pump into the system.
2. Fully open the suction and discharge valves.
3. Allow fluid to flow into the pump. Do not allow the pump to run dry (ceramic, PTFE and silicon carbide bushings can't be run dry without damage to pump components).
4. Jog the motor (allow it to run for 1-2 seconds) and observe the rotation of the motor fan. Refer to the directional arrow molded into the pump casing if necessary.

Note: A pump running backwards will pump but at a greatly reduced flow and pressure.

Section III - Start-up and Operation

1. This pump must be filled from a flooded suction tank (gravity) or primed with liquid from an outside source. DB Series pumps are not self-priming.
2. Open the inlet (suction) and discharge valves completely and allow the pump to fill with liquid.
3. Close the discharge valve.
4. Turn the pump on. Slowly open the discharge valve. Adjust the flow rate and pressure by regulating the discharge valve. Do not attempt to adjust the flow with the suction valve.
5. Use of a power monitor is strongly recommended for pumps with ceramic, PTFE or silicon carbide bushings. The power monitor will stop the pump and help prevent damage if the pump should run dry.

Shutdown

Use the following procedure to shutdown the pump.

1. Slowly close the discharge valve.
2. Turn off the motor.
3. Close the suction valve.

Flush Systems

⚠ CAUTION: Some fluids react with water; use compatible flushing fluid.

1. Turn off the pump.
2. Completely close the suction and discharge valves
3. Connect flushing fluid supply to flush inlet valve.
4. Connect flushing fluid drain to flush drain valve.
5. Open flushing inlet and outlet valves. Flush system until the pump is clean.

Optional Drain Installation

1. Remove the impeller housing (item 1) from the pump assembly.
2. Clamp the impeller housing to a drill press table.
3. Using a 7/16" drill and the molded boss as a guide, drill completely through the molded boss into the interior of the impeller housing.

⚠ CAUTION: Do not tap too deep or the impeller housing may be damaged.

4. Using a 1/4" NPT tap, tap the hole in the molded boss to the appropriate depth.
5. Install the drain plug or valve, being careful not to over-tighten.

Section IV - Maintenance

Recommended maintenance schedule

The recommended maintenance schedule depends upon the nature of the fluid being pumped and the specific application. If the pump is used on a clean fluid, it is recommended that the pump be removed from service and examined after six months of operation or after 2,000 hours of operation. If the pump is used on fluids with solids, high temperatures or other items that could cause accelerated wear, then this initial examination should be sooner.

After the initial examination of the internal components and wear items are measured, a specific maintenance schedule can be determined. For best results, it is recommended that the pump be removed from service annually for examination.

Section V - Disassembly



⚠ WARNING: Rotating Parts. This pump has components that rotate while in operation. Follow local safety standards for locking out the motor from the power supply during maintenance or service.

⚠ WARNING: Chemical Hazard. This pump is used for transferring many types of potentially dangerous chemicals. Always wear protective clothing, eye protection and follow standard safety procedures when handling corrosive or personally harmful materials. Proper procedures should be followed for draining and decontaminating the pump before disassembly and inspection of the pump. There may be small quantities of chemicals present during inspection.

⚠ WARNING: Magnetic force hazard. This pump should only be disassembled and assembled using the recommended procedures. The magnetic attraction is powerful enough to rapidly pull the motor end and the wet end together. Do not place fingers between the mating surfaces of the motor and wet ends to avoid injuries. Keep the drive

magnet and impeller assembly away from metal chips or particles.

1. Stop the pump, lock out the motor starter, close all the valves that are connected to the pump, and drain/decontaminate the pump.

⚠ WARNING: The pump must be thoroughly flushed of any hazardous materials and all internal pressure relieved prior to opening the pump. Allow the pump to reach ambient temperatures prior to performing maintenance.

2. Securely clamp the motor to the bench. Remove the (4) bolts, lock washers and flat washers (items 24, 25, 26) securing the pump to the motor.



Figure 10

3. Firmly grab the pump and pull straight back to disengage the motor and the pump. See figure 10.

4. Place pump on bench with housing facing up. Remove (6) 8 mm housing bolts, lock washers and flat washers (items 15, 16, 17). See figure 11.



Figure 11

5. Pull housing (item 1) straight up to remove. Inspect housing for signs of wear or damage. Look for signs of rubbing, cracked thrust ring or damage to front shaft support. See figure 12.



Figure 12

6. Remove impeller/inner drive assembly (items 4A, 4, 5, 5A). Inspect impeller and drive for signs of wear or damage. Look for signs of rubbing, damage and wear to the impeller and inner drive. See figure 13.



Figure 13

Check the impeller thrust ring and bushing for wear. See figure 14.

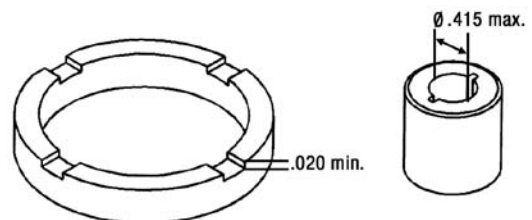

Figure 14

- Remove the impeller shaft (item 6) from the barrier and check for signs of cracking, chipping, scoring or wear. See figure 15.
- Remove the barrier (item 7) from the motor adapter (item 11) (make sure the shaft has been removed). If necessary, gently tap on the back side of the barrier with a soft rod (wood, plastic, etc). Inspect the inside and outside of the barrier for signs of rubbing. See figure 16.
- Remove the o-ring (item 3) from the barrier and inspect for chemical attack, swelling, brittleness, cuts, etc.
- Visually inspect the outer drive (item 13) for rubbing, damage, corrosion or loose magnets.



Figure 15



Figure 16



Figure 20



Figure 21

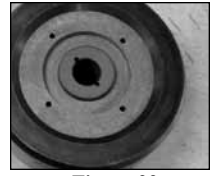

Figure 22

Impeller Replacement



To remove the impeller from the inner drive magnet, gently pry off by hand or lightly tap on the back of the impeller.

To install a new impeller, place the inner drive magnet assembly face up. Line up the patterns on the impeller with the ones on the inner drive magnet so they match and press into place by hand. An arbor press can also be used to press the impeller on the inner drive. Place a piece of wood over the top of the impeller thrust ring and push down on the impeller until it is completely seated in the inner drive. See figure 23.



Figure 23

Outer Drive Replacement

- Remove the setscrews (item 13B) from the side of the drive (NEMA motors) or the bolt, lock washer and flat washer (items 21, 22, 23) from the center of the drive (metric motors).

⚠ WARNING: Be careful, tools will want to be attracted to the magnets.

- Remove the drive magnet from the motor shaft by gently prying up from the bottom of the drive. See figure 17.



Figure 17

- To reinstall the drive or a new drive follow the instructions from Section I - Assembly, Pumps without Motors, steps 5 & 6.

Thrust Ring Replacement

- Thrust ring (item 4A) is held in-place with a snap fit with a ridge. Using a razor knife or side cutters, cut a notch out of the thrust ring. Pull ring up and out of the holder. See figures 18 and 19.
- To reinstall, align the two flats on the thrust ring with the flats in the bore of the impeller. Using a piece of wood press into place using an arbor press until the thrust ring is completely seated in the impeller.

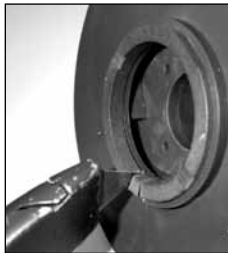

Figure 18

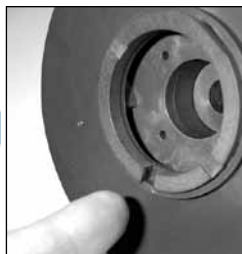

Figure 19

Bushing Replacement



To remove the bushing, place the impeller/inner drive assembly in an arbor press. Insert a 7/16" diameter plastic or wood shaft through the eye of the impeller and press the bushing out.

To replace the bushing (item 5A), place the top of the impeller on an arbor press with the thrust ring face down. Insert the front of the bushing into the center of the impeller/inner drive magnet assembly. Press into place until the bushing reaches the shoulder molded into the inner drive. See figures 20, 21, 22.



Figure 24



Figure 25



Figure 26

- Install (4) bolts, lock washers and flat washers (items 20, 19, 18). Tighten evenly using a star pattern. Tighten to 60 in-lb (6.8 N-m). See figure 27.

- Install barrier (item 7) into motor adapter and clamp ring assembly. Lubricate the o-ring with a chemically compatible lubricant, and install it in the groove in the clamp ring before installing the barrier. See figure 27A. Push barrier into place. See figure 27B.

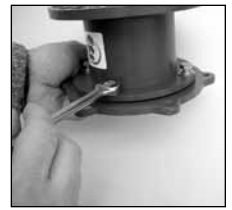

Figure 27



Figure 27A



Figure 27B

5. Install o-ring (item 3) in groove in the barrier.

6. Install impeller shaft (item 6) into barrier by aligning the flats on the shaft with the flats in the barrier. Make sure it is completely seated. See figure 28.



Figure 28

7. Carefully install the impeller/inner drive assembly (items 4A, 4, 5, 5A) by sliding it over the impeller shaft in the barrier. It is normal for the impeller/inner drive to pop up a slight amount due to magnetic forces. See figures 29 and 30.



Figure 29

8. Establish the bottom of the motor adapter/clamp ring assembly. See figures 25 and 26.

9. Install the impeller housing making sure that the discharge is in correct orientation (vertical or horizontal). Align the shaft in the barrier with the front shaft support in the impeller housing. Pressing down, push the impeller/inner drive magnet assembly into position. Holding the impeller housing with one hand, install and finger-tighten two bolts, lock washers and flat washers (items 15, 16, 17) in opposite locations. See figure 31.



Figure 30

10. Install the remaining bolts, lock washers and flat washers finger tight.

11. Tighten all the bolts evenly using a star pattern. Tighten to 60 inch-lbs (6.8 N-m).

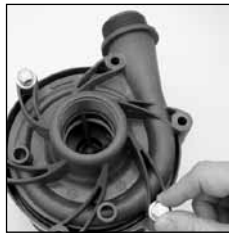

Figure 31

12. Reinstall the pump on the motor/drive magnet following instructions found in "Assembly, Pumps without motors," steps 7-10.

Section VII - Troubleshooting

General Notes:

- Do not pump liquids containing ferrous metal fines.
- If magnets decouple, stop pump immediately. Operating the pump with the magnets decoupled will eventually weaken the magnets.
- Do not use mismatched drive magnet assemblies (different number of magnets on inner and outer drive magnet assemblies).
- Contact our Technical Service Department at 1-800-888-3743 or by e-mail at techservice@finishthompson.com if you have any questions regarding product operation or repair.

No or Insufficient Discharge

- Air leaks in suction piping
- Pump not primed
- System head higher than anticipated
- Closed valve
- Viscosity or specific gravity too high
- Motor too large for magnet coupling rating (magnets uncoupled)
- Suction lift too high or insufficient NPSH
- Clogged suction line or impeller vanes
- Motor rotation incorrect (correct rotation when viewed from the fan end is clockwise)

Insufficient Pressure

- Air or gas in liquid
- Impeller diameter too small
- System head lower than anticipated
- Motors speed insufficient (too low) or motor rotation incorrect (correct rotation when viewed from the fan end is clockwise)

Loss of Prime

- Leak in suction piping
- Foot valve or suction opening not submerged enough
- Foot valve too small or leaking
- Air or gas in liquid
- Foreign matter in impeller
- Leaking valve. Suction lift too high or insufficient NPSHa.

Excessive Power Consumption

- Head lower than rating
- Excessive flow
- Specific gravity or viscosity too high.

Vibration/Noise

- Loose magnet
- Drive magnet rubbing
- Pump cavitating from improper suction or feed
- Motor or piping not properly secured
- Foreign object in impeller

Section VIII - Warranty

Finish Thompson, Inc (manufacturer) warrants this pump product to be free of defects in materials and workmanship for a period of five years from date of purchase by original purchaser. If a warranted defect, which is determined by manufacturer's inspection, occurs within this period, it will be repaired or replaced at the manufacturer's option, provided (1) the product is submitted with proof of purchase date and (2) transportation charges are prepaid to the manufacturer. Liability under this warranty is expressly limited to repairing or replacing the product or parts thereof and is in lieu of any other warranties, either expressed or implied. This warranty does not apply to normal wear of the product or components. This warranty does not apply to products or parts broken due to, in whole or in part, accident, overload, abuse, chemical attack, tampering, or alteration. The warranty does not apply to any other equipment used or purchased in combination with this product. The manufacturer accepts no responsibility for product damage or personal injuries sustained when the product is modified in any way. If this warranty does not apply, the purchaser shall bear all cost for labor, material and transportation.

Manufacturer shall not be liable for incidental or consequential damages including, but not limited to, process down time, transportation costs, costs associated with replacement or substitution products, labor costs, product installation or removal costs, or loss of profit. In any and all events, manufacturer's liability shall not exceed the purchase price of the product and/or accessories.

Ordering Spare Parts

Spare parts can be ordered from your local distributor. Always refer to the pump model to avoid error.

Other FTI Products

See our full product range at www.finishthompson.com.

PART NUMBER EXPLANATION

1. Select base model (E.G. DB10P*)

2. If standard components are not suitable, enter symbol(s) of alternative components in any order.

Base Model - - - - -
 DB10P E-Ff-14

DB10P-E-Ff-14 is a DB10P with EPDM O-ring, fiberglass flanges and 145TC motor.

3. Alternative components - select from chart.

*The model number is on the serial number label located on the motor adapter. The model number contains a base model that features certain standard components. Compare the model number on the pump to the chart below to determine if the pump contains any alternate components. Model numbers containing "P" have primary components molded from polypropylene. Model numbers containing "V" have primary components molded from PVDF.

Base model numbers are: DB6P, DB6V, DB6HP, DB6HV, DB7P, DB7V, DB8P, DB8V, DB9P, DB9V, DB10P, DB10V.

BASE MODEL COMPONENTS		ALTERNATIVE COMPONENTS		Code						
Bushing	Graphite Carbon	PTFE		T						
		Alumina Ceramic*		R						
O-Ring	FKM	EPDM		E						
		Simriz*		S						
		Kalrez*		K						
Connection	NPT	BSP Threads		B						
		Union*		U						
		Steel enforced flange*		Fs						
		Fiberglass enforced flange*		Ff						
Impeller	1 (Max size 60 Hz)	Select impeller from page #								
		2	3	4	5	6	7	8	9	10
Magnet	DB6/6H/7: 6-Pole DB8/9/10: 8-Pole (Upgrade for specific gravity corrections)	6-Pole: up to .5 HP/.38 kW (56C, 63, 71 frame)			6p					
		8-Pole: up to 1 HP/.75 kW (56C, 145, 63, 71, 80 frame)*			8p					
		10-Pole: up to 2 HP/1.5 kW (56C, 145, 63, 71, 80, 90 frame)*			10p					
Motor Adapter	56C NEMA	145TC NEMA			14					
		IEC 63/B14			64					
		IEC 71/B14			74					
		IEC 80/B14			84					
		IEC 90/B14			94					
		IEC 63/B5			65					
		IEC 71/B5			75					
		IEC 80/B5			85					
		IEC 90/B5			95					
Specials	SS hardware, PTFE/ceramic thrust rings, ceramic shaft, Buna o-ring vapor protection kit option (NEMA only)	SiC bushing, thrust ring, shaft*			Si					
		Hastelloy shaft*			Hs					
		Titanium hardware*			Ti					
		FKM o-ring vapor protection kit (NEMA only)*			Vv					
		EPDM o-ring vapor protection kit (NEMA only)*			Ve					
		ATEX (PVDF only)*			A					
		Non-sparking ring*			Ns					
Motor	Not Standard	Select Motor Reference Number from Motor Price Sheets								

DB 6 - 10 SPARE PARTS DIAGRAM

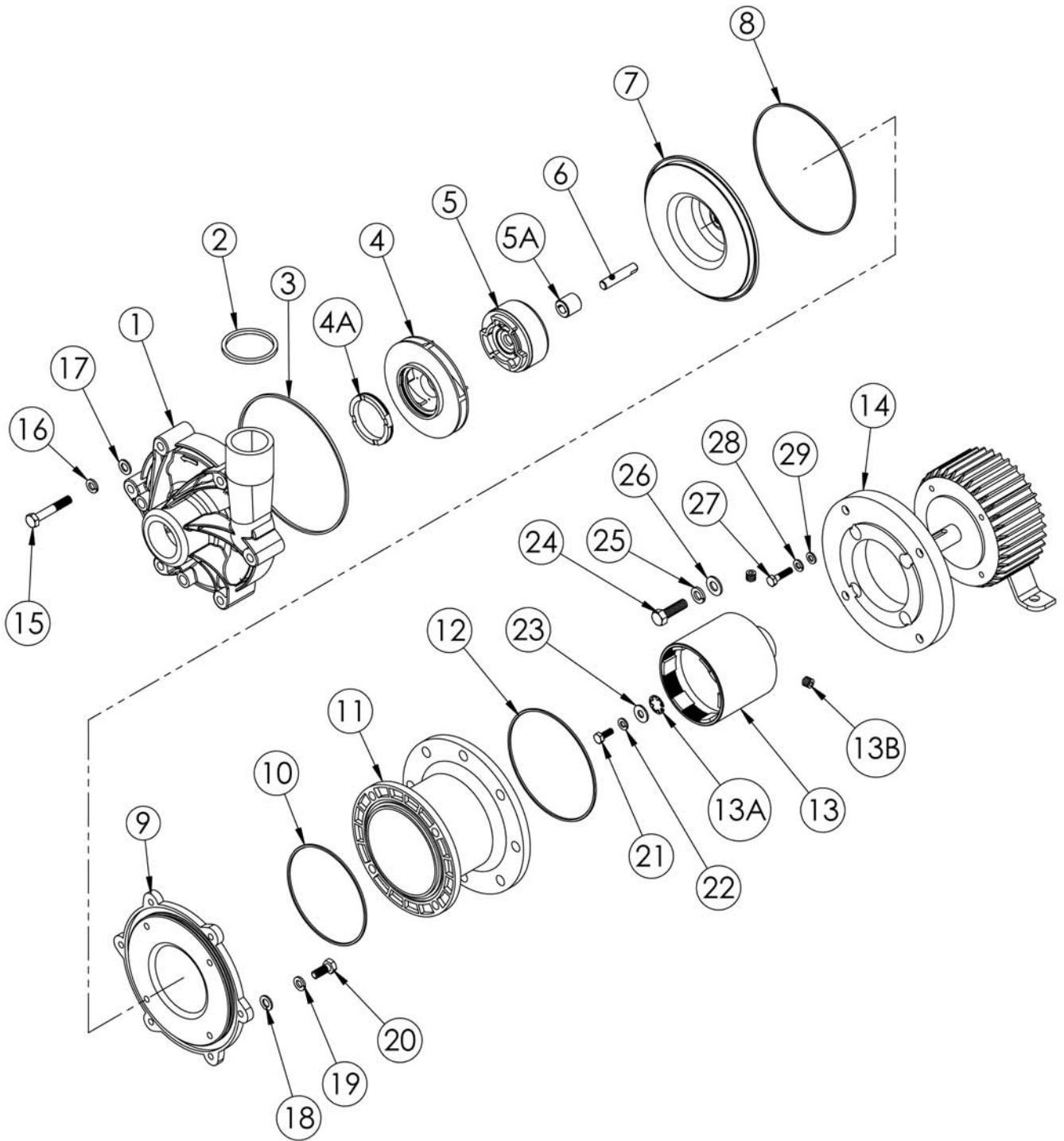

DB 6 - 10 SPARE PARTS LIST

Item	Qty	Description	DB6/6H/9		DB8		DB7/10	
			Pump Material		Pump Material		Pump Material	
			Polypro	PVDF	Polypro	PVDF	Polypro	PVDF
1	1	Housing w/ Ring						
		NPT threads & standard ceramic ring	106265	106265-1	106337	106337-1	106252	106252-1
		BSP threads & standard ceramic ring	106265-2	106265-3	106337-2	106337-3	106252-2	106252-3
		FRP flanges & standard ceramic ring	106369	106369-1	106384	106384-1	106365	106365-1
		Steel flanges & standard ceramic ring	106369-2	106369-3	106384-2	106384-3	106365-2	106365-3
		Unions & standard ceramic ring	106377	106377-1	106382	106382-1	106367	106367-1
		NPT Threads & optional SiC Ring	106346	106346-1	106381	106381-1	106345	106345-1
		BSP Threads & optional SiC Ring	106346-2	106346-3	106381-2	106381-3	106345-2	106345-3
		FRP Flanges & optional SiC Ring	106370	106370-1	106385	106385-1	106366	106366-1
		Steel Flanges & optional SiC Ring	106370-2	106370-3	106385-2	106385-3	106366-2	106366-3
Unions & optional SiC Ring	106378	106378-1	106383	106383-1	106368	106368-1		
2	1	Discharge O-ring (BSP Housings Only)						
		FKM			106303			105919
		EPDM			106304			105918
		Simriz			106306			105921
		Kalrez			106305			105920
3	1	Housing O-ring						
		FKM - standard					106298	
		EPDM - optional					106299	
		Simriz - optional					106301	
		Kalrez - optional					106300	
4	1	Impeller						
<i>See DB6-10 Impeller Assemblies Table on pg 31</i>								
4A	1	Impeller Thrust Ring Only						
		Filled PTFE (standard)					106257	
		SiC (optional)					106257-1	
5	1	Impeller Drive Assembly						
		6-pole w/ carbon bushing (standard)	106361	106361-3	106361	106361-3	106361	106361-3
		8-pole w/ carbon bushing (standard)	106361-1	106361-4	106361-1	106361-4	106361-1	106361-4
		10-pole w/ carbon bushing (standard)	106361-2	106361-5	106361-2	106361-5	106361-2	106361-5
		6-pole w/ PTFE bushing (optional)	106362	106362-3	106362	106362-3	106362	106362-3
		8-pole w/ PTFE bushing (optional)	106362-1	106362-4	106362-1	106362-4	106362-1	106362-4
		10-pole w/ PTFE bushing (optional)	106362-2	106362-5	106362-2	106362-5	106362-2	106362-5
		6-pole w/ ceramic bushing (optional)	106363	106363-3	106363	106363-3	106363	106363-3
		8-pole w/ ceramic bushing (optional)	106363-1	106363-4	106363-1	106363-4	106363-1	106363-4
		10-pole w/ ceramic bushing (optional)	106363-2	106363-5	106363-2	106363-5	106363-2	106363-5
		6-pole w/ SiC bushing (optional)	106364	106364-3	106364	106364-3	106364	106364-3
		8-pole w/ SiC bushing (optional)	106364-1	106364-4	106364-1	106364-4	106364-1	106364-4
		10-pole w/ SiC bushing (optional)	106364-2	106364-5	106364-2	106364-5	106364-2	106364-5
5A	1	Impeller Bushing Only						
		Carbon (standard)					J102387	
		Filled PTFE (optional)					J102790	
		Ceramic (optional)					J103617	
		SiC (optional)					J103617-1	
6	1	Impeller Shaft						
		Ceramic (standard)					106293	
		SiC (optional)					106293-1	
		Hastelloy C (optional)					106293-2	
7	1	Barrier						
		With silicon carbide thrust washer	106235-4	106235-5	106235-4	106235-5	106235-4	106235-5
8	1	Barrier O-Ring (For Vapor Protection Kit Option for NEMA Motors Only)						
		Buna N					106572	
		EPDM					106550	
		FKM					106551	

Item	Qty	Description	DB6/6H/9		DB8		DB7/10	
			Pump Material		Pump Material		Pump Material	
			Polypro	PVDF	Polypro	PVDF	Polypro	PVDF
9	1	Clamp Ring						
		Standard	106246	106246-1	106246	106246-1	106246	106246-1
		Bronze Ring	106521	106521-1	106521	106521-1	106521	106521-1
		ATEX	N/A	106521-1	N/A	106521-1	N/A	106521-1
10	1	Clamp Ring O-Ring (For Vapor Protection Kit Option for NEMA Motors Only)						
		Buna N				106548		
		EPDM				106372		
		FKM				J103954		
11	1	Motor Adapter Column						
		Standard	106248	106248-1	106248	106248-1	106248	106248-1
		ATEX	N/A	106248-2	N/A	106248-2	N/A	106248-2
12	1	Motor Adapter O-ring (For Vapor Protection Kit Option for NEMA Motors Only)						
		Buna N				106549		
		EPDM				106373		
		FKM				106374		
13	1	Drive Magnet Assembly with Retaining Ring (56C Frame Also Includes Set Screws)						
		56C frame, 6-pole				106283		
		56C frame, 8-pole				106283-1		
		56C frame, 10-pole				106283-2		
		145TC frame, 8-pole				106283-4		
		145TC frame, 10-pole				106283-5		
		63 frame, 6-pole				106289		
		63 frame, 8-pole				106289-1		
		63 frame, 10-pole				106289-2		
		71 frame, 6-pole				106286		
		71 frame, 8-pole				106286-1		
		71 frame, 10-pole				106286-2		
		80 frame, 8-pole				106292-1		
		80 frame, 10-pole				106292-2		
90 Frame, 10-pole				106292-5				
13A	1	Retaining Ring Only						
		56C frame				105708		
		145 frame				105709		
		63 frame				106310		
		71 frame				106309		
		80 frame				105711		
		90 frame				105712		
13B	2	Set Screws (NEMA Motor Only)						
		Stainless steel				J101084		
14	1	Motor Adapter Flange (IEC Motor Only)						
		63/71 frame w/ B14 flange	106271	106271-1	106271	106271-1	106271	106271-1
		80 frame w/ B14 flange	105724-1	105724-2	105724-1	105724-2	105724-1	105724-2
		90 frame w/ B14 flange	105725-1	105725-2	105725-1	105725-2	105725-1	105725-2
		63 frame w/ B5 flange	106272	106272-1	106272	106272-1	106272	106272-1
		71 frame w/ B5 flange	106273	106273-1	106273	106273-1	106273	106273-1
		80/90 frame w/ B5 flange	106274	106274-1	106274	106274-1	106274	106274-1
		63 frame w/ B14 flange ATEX	N/A	106271-2	N/A	106271-2	N/A	106271-2
		80 frame w/ B14 flange ATEX	N/A	105724-3	N/A	105724-3	N/A	105724-3
		90 frame w/ B14 flange ATEX	N/A	105725-3	N/A	105725-3	N/A	105725-3
		63 frame w/ B5 flange ATEX	N/A	106272-2	N/A	106272-2	N/A	106272-2
		80 frame w/ B5 flange ATEX	N/A	106273-2	N/A	106273-2	N/A	106273-2
		90 frame w/ B5 flange ATEX	N/A	106274-2	N/A	106274-2	N/A	106274-2

Hardware - All DB6-10 Models

Item	Qty	Description	Stainless Steel	Titanium
15	6	Housing Bolt		
			J102789	106308
16	6	Housing Lock Washer		
			J102282	J103847
17	6	Housing Flat Washer		
			105767	105768
18	4	Clamp Ring Flatwasher		
			105767	105768
19	4	Clamp Ring Lockwasher		
			J102282	J103847
20	4	Clamp Ring Bolt		
			105770	105771
21	1	Drive Bolt (IEC Motors Only)		
		63 frame	106314	106315
		71 frame	106312	106313
		80 frame	105765	105766
		90 frame	105770	105771
22	1	Drive Lockwasher (IEC Frames Only)		
		63 frame	106322	106323
		71 frame	106320	106321
		80 frame	J100672	J104203
		90 frame	J102282	J103847
23	1	Drive Flatwasher (IEC Frames Only)		
		63 frame	106318	106319
		71 frame	106316	106317
		80 frame	105767	105768
		90 frame	105722	105773
24	4	Motor Adapter Bolt		
			J100114	106311
25	4	Motor Adapter Lockwasher		
			J100115	J104206
26	4	Motor Adapter Flatwasher		
			J100128	J104207
27	4	Motor Adapter Flange Bolt (IEC Frames Only)		
		63 frame	106348	106349
		71 frame	105765	105766
		80 frame	105765	105766
		90 frame	105770	105771
28	4	Motor Adapter Lockwasher (IEC Frames Only)		
		63 frame	J103637	106350
		71 frame	J100672	J104203
		80 frame	J100672	J104203
		90 frame	J102282	J103847
29	4	Motor Adapter Flatwasher (IEC Frames Only)		
		63 frame	J103638	106351
		71 frame	J100113	J104204
		80 frame	J100113	J104204
		90 frame	J101293	J103845

Impeller Assemblies

Model	Thrust Ring Material	Impeller Material	#1	#2	#3	#4	#5	#6	#7	#8	#9
DB6	Impeller Diameter (in.)		3.00	2.75	2.50	3.50	3.25	3.00	2.75	N/A	N/A
	PTFE	Polypro	106356-4	106356-6	106356-8	106356	106356-2	106356-4	106356-6	N/A	N/A
		PVDF	106356-5	106356-7	106356-9	106356-1	106356-3	106356-5	106356-7	N/A	N/A
	Silicon Carbide	Polypro	106357-4	106357-6	106357-8	106357	106357-2	106357-4	106357-6	N/A	N/A
		PVDF	106357-5	106357-7	106357-9	106357-1	106357-3	106357-5	106357-7	N/A	N/A
DB6H	Impeller Diameter (in.)		3.88	3.63	3.38	3.12	4.18	4.00	3.75	3.50	N/A
	PTFE	Polypro	106536	106536-2	106536-4	106536-6	106358	106358-2	106358-4	106358-6	N/A
		PVDF	106536-1	106536-3	106536-5	106536-7	106358-1	106358-3	106358-5	106358-7	N/A
	Silicon Carbide	Polypro	106537	106537-2	106537-4	106537-6	106359	106359-2	106359-4	106359-6	N/A
		PVDF	106537-1	106537-3	106537-5	106537-7	106359-1	106359-3	106359-5	106359-7	N/A
DB7	Impeller Diameter (in.)		3.18	3.00	2.75	3.63	3.38	3.12	N/A	N/A	N/A
	PTFE	Polypro	106354-4	106354-8	106354-10	106354	106354-2	106354-6	N/A	N/A	N/A
		PVDF	106354-5	106354-9	106354-11	106354-1	106354-3	106354-7	N/A	N/A	N/A
	Silicon Carbide	Polypro	106355-4	106355-8	106355-10	106355	106355-2	106355-6	N/A	N/A	N/A
		PVDF	106355-5	106355-9	106355-11	106355-1	106355-3	106355-7	N/A	N/A	N/A
DB8	Impeller Diameter (in.)		3.63	3.38	3.12	2.88	4.18	4.00	3.75	3.50	N/A
	PTFE	Polypro	106379-8	106379-10	106379-12	106379-14	106379	106379-2	106379-4	106379-6	N/A
		PVDF	106379-9	106379-11	106379-13	106379-15	106379-1	106379-3	106379-5	106379-7	N/A
	Silicon Carbide	Polypro	106380-8	106380-10	106380-12	106380-14	106380	106380-2	106380-4	106380-6	N/A
		PVDF	106380-9	106380-11	106380-13	106380-15	106380-1	106380-3	106380-5	106380-7	N/A
DB9	Impeller Diameter (in.)		4.18	N/A	N/A	N/A	N/A	N/A	N/A	N/A	N/A
	PTFE	Polypro	106358	N/A	N/A	N/A	N/A	N/A	N/A	N/A	N/A
		PVDF	106358-1	N/A	N/A	N/A	N/A	N/A	N/A	N/A	N/A
	Silicon Carbide	Polypro	106359	N/A	N/A	N/A	N/A	N/A	N/A	N/A	N/A
		PVDF	106359-1	N/A	N/A	N/A	N/A	N/A	N/A	N/A	N/A
DB10	Impeller Diameter (in.)		3.75	3.50	3.25	3.00	4.18	4.00	3.75	3.50	3.25
	PTFE	Polypro	106352-4	106352-6	106352-8	106352-10	106352	106352-2	106352-4	106352-6	106352-8
		PVDF	106352-5	106352-7	106352-9	106352-11	106352-1	106352-3	106352-5	106352-7	106352-9
	Silicon Carbide	Polypro	106353-4	106353-6	106353-8	106353-10	106353	106353-2	106353-4	106353-6	106353-8
		PVDF	106353-5	106353-7	106353-9	106353-11	106353-1	106353-3	106353-5	106353-7	106353-9



FINISH THOMPSON INC.

921 Greengarden Road • Erie, PA 16501-1591 U.S.A.
Ph 814-455-4478 • Fax 814-455-8518

Email fti@finishthompson.com • www.finishthompson.com

Part Number 106577

Order fax: 814-459-3460

Tech Service: 800-888-3743

Literature ID No. FT07-975, R6, 7.2.12

